

- **Instruction Cycle Time**
  - 100 ns . . . TMS34020A-40
  - 125 ns . . . TMS34020-32
  - 125 ns . . . TMS34020A-32
- **Fully Programmable 32-Bit General-Purpose Processor With 512-Megabyte Linear Address Range (Bit Addressable)**
- **Second-Generation Graphics Processor**
  - Object Code Compatible With the TMS34010
  - Enhanced Instruction Set
  - Optimized Graphics Instructions
  - TMS34082 Graphics Floating-Point Interface
- **Pixel Processing, XY Addressing, and Window Checking Built into the Instruction Set**
- **Programmable 1-, 2-, 4-, 8-, 16-, or 32-Bit Pixel Size With 16 Boolean and 6 Arithmetic Pixel-Processing Options (Raster-Ops)**
- **512-Byte LRU On-Chip Instruction Cache**
- **Optimized DRAM/VRAM Interface**
  - Page-Mode for Burst Memory Operations up to 40 Megabytes per Second
  - Dynamic Bus Sizing (16-Bit and 32-Bit Transfers)
  - Byte-Oriented  $\overline{\text{CAS}}$  Strobes
- **Flexible Host Processor Interface**
  - Supports Host Transfers at up to 20 Megabytes per Second
  - Direct Access to All of the TMS34020 Address Space
  - Implicit Addressing
  - Prefetch for Enhanced Read Access
- **Flexible Multiprocessor Interface**
- **Programmable CRT Control**
  - Composite Sync Mode
  - Separate Sync Mode
  - Synchronization to External Sync
- **Direct Support for Special Features of 1M VRAMs**
  - Load Write Mask
  - Load Color Mask
  - Block Write
  - Write Using the Write Mask

**145-PIN GB PACKAGE  
(TOP VIEW)**

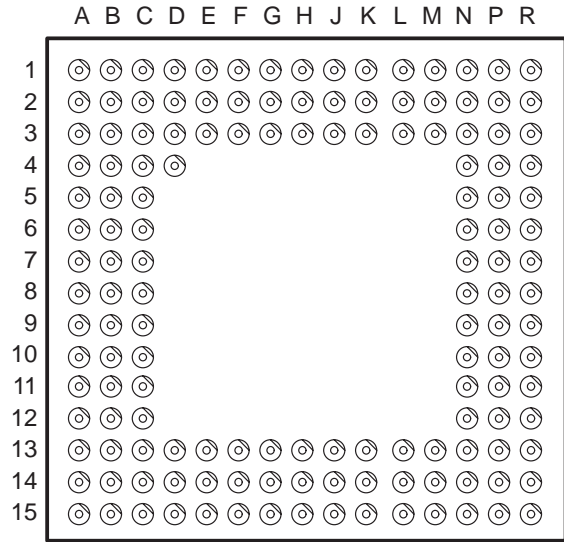

**144-PIN PCM QUAD FLAT PACKAGE  
(TOP VIEW)**

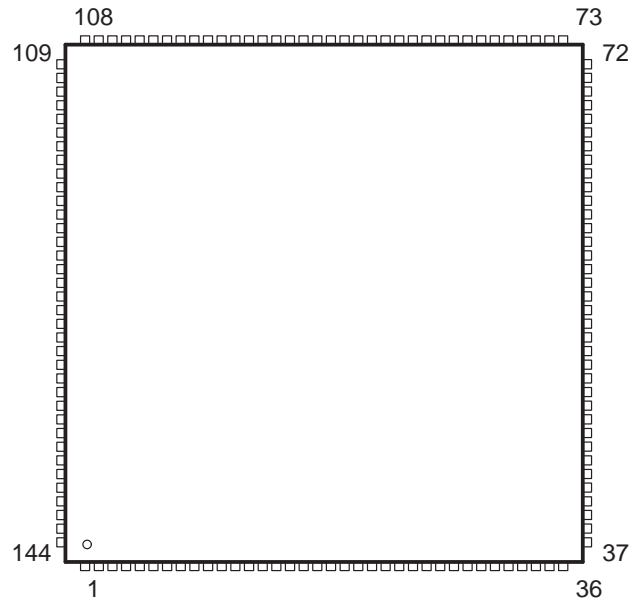

PRODUCTION DATA information is current as of publication date. Products conform to specifications per the terms of Texas Instruments standard warranty. Production processing does not necessarily include testing of all parameters.

# TMS34020, TMS34020A GRAPHICS PROCESSORS

SPVS004D – MARCH 1990 – REVISED NOVEMBER 1993

---

## description

The TMS34020 and the TMS34020A graphics processors are the second generation of an advanced high-performance CMOS 32-bit microprocessor optimized for graphics display systems. With a built-in instruction cache, the ability to simultaneously access memory and registers, and an instruction set designed to expedite raster graphics operations, the TMS34020 and TMS34020A provide user-programmable control of the CRT interface as well as the memory interface (both standard DRAM and multiport video RAM). The 4-gigabit (512-megabyte) physical address space is addressable on bit boundaries using variable-width data fields (1 to 32 bits). Additional graphics addressing modes support 1-, 2-, 4-, 8-, 16- and 32-bit wide pixels.

The information contained in this data sheet is applicable to both the TMS34020 and the TMS34020A, except that pertaining to clock stretch, which begins on page 21. Use of the term TMS34020 shall refer to both devices except where noted.

## architecture

The TMS34020 is a CMOS 32-bit processor with hardware support for graphics operations such as PixBlts (raster ops) and curve-drawing algorithms. Also included is a complete set of general-purpose instructions with addressing modes tuned to support high-level languages. In addition to its ability to address a large external memory range, the TMS34020 contains 30 general-purpose 32-bit registers, a hardware stack pointer, and a 512-byte instruction cache. On-chip functions include 64 programmable I/O registers that control CRT timing, input/output control, and parameters required by some instructions. The TMS34020 directly interfaces to dynamic RAMs and video RAMs and generates raster control signals. The TMS34020 can be configured to operate as a standalone processor, or it can be used as a graphics engine with a host system. The host interface provides a generalized communication port for any standard host processor. The TMS34020 also accommodates a multiprocessing or direct memory access (DMA) environment through the request/grant interface protocols. Virtual memory systems are supported through bus-fault detection and instruction continuation.

The TMS34020 provides single-cycle execution of general-purpose instructions and most common integer arithmetic and Boolean operations from its instruction cache. Additionally, the TMS34020 incorporates a hardware barrel shifter that provides a single-state bidirectional shift-and-rotate function for 1 to 32 bits.

The local-memory controller is designed to optimize memory-access operations. It also supports pipeline memory-write operations of variable-sized fields and allows memory access and instruction execution in parallel.

The TMS34020 graphics processing hardware supports pixel and pixel-array processing capabilities for both monochrome and color systems at a variety of pixel sizes. The hardware incorporates two-operand and three-operand raster operations with Boolean and arithmetic operations, XY addressing, window clipping, window-checking operations, 1 to  $n$  bits-per-pixel transforms, transparency, and plane masking. The architecture further supports operations on single pixels (PIXT instructions) or on two-dimensional arrays of arbitrary size (PixBlts).

The TMS34020's flexible graphics processing capabilities allow software-based graphics algorithms without sacrificing performance. These algorithms include clipping to arbitrary window size, custom incremental curve drawing, two-operand raster operations, and masked two-operand raster operations.

The TMS34020 provides for extensions to the basic architecture through the coprocessor interface. Special instructions and cycle timings are included to enhance data flow to coprocessors, such as the TMS34082 floating-point unit, without requiring the coprocessor to decode the instruction stream, generate system addresses, or move data for the coprocessor through the TMS34020.



pin assignments – GBL pin-grid-array package

PIN NO.	FUNCTION	PIN NO.	FUNCTION	PIN NO.	FUNCTION	PIN NO.	FUNCTION
A1	V <sub>SS</sub>	C9	RCA8	J1	EMU0	N15	LAD17
A2	ALTCH	C10	RCA12	J2	GI	P1	V <sub>CC</sub>
A3	CBLNK/VBLNK	C11	LAD30	J3	EMU1	P2	HWRITE
A4	HSYNC	C12	V <sub>SS</sub>	J13	LAD4	P3	HCS
A5	TR/QE	C13	V <sub>SS</sub>	J14	V <sub>CC</sub>	P4	HA30
A6	RCA2	C14	V <sub>CC</sub>	J15	LAD5	P5	HA27
A7	RCA3	C15	LAD26	K1	EMU2	P6	HA24
A8	V <sub>CC</sub>	D1	RAS	K2	RESET	P7	HA22
A9	RCA6	D2	CAS2	K3	LINT2	P8	HA18
A10	RCA7	D3	V <sub>SS</sub>	K13	V <sub>SS</sub>	P9	HA14
A11	RCA10	D4†	NC	K14	LAD3	P10	HA13
A12	SCLK	D13	LAD28	K15	LAD20	P11	HA10
A13	LAD15	D14	LAD11	L1	LINT1	P12	HA7
A14	LAD29	D15	LAD10	L2	CAMD	P13	HA5
A15	V <sub>SS</sub>	E1	R1	L3	LRDY	P14	HBS0
B1	CAS3	E2	V <sub>CC</sub>	L13	LAD1	P15	LAD0
B2	WE	E3	CAS1	L14	LAD2	R1	HREAD
B3	V <sub>SS</sub>	E13	LAD27	L15	LAD19	R2	HA31
B4	CSYNC/HBLNK	E14	LAD25	M1	BUSFLT	R3	HA28
B5	VS <sub>YN</sub> C	E15	LAD9	M2	PGMD	R4	HA26
B6	RCA0	F1	HRDY	M3	VCLK	R5	HA23
B7	RCA1	F2	R0	M13	V <sub>SS</sub>	R6	HA20
B8	RCA5	F3	V <sub>SS</sub>	M14	LAD16	R7	HA19
B9	RCA9	F13	LAD24	M15	LAD18	R8	HA17
B10	RCA11	F14	LAD8	N1	SIZE16	R9	HA16
B11	LAD31	F15	V <sub>SS</sub>	N2	V <sub>CC</sub>	R10	HA15
B12	LAD14	G1	HINT	N3	CLKIN	R11	HA11
B13	V <sub>CC</sub>	G2	HOE	N4	V <sub>SS</sub>	R12	HA9
B14	LAD13	G3	HDST	N5	HA29	R13	HA8
B15	LAD12	G13	LAD7	N6	HA25	R14	HBS3
C1	CAS0	G14	V <sub>SS</sub>	N7	HA21	R15	V <sub>SS</sub>
C2	V <sub>CC</sub>	G15	LAD23	N8	V <sub>SS</sub>		
C3	DDOUT	H1	LCLK1	N9	V <sub>SS</sub>		
C4	DDIN	H2	EMU3	N10	HA12		
C5	V <sub>SS</sub>	H3	LCLK2	N11	HA6		
C6	SF	H13	LAD22	N12	HBS2		
C7	RCA4	H14	LAD21	N13	HBS1		
C8	V <sub>SS</sub>	H15	LAD6	N14	V <sub>CC</sub>		

† User must leave pin D4 unconnected. It is provided for device orientation purposes only.

# TMS34020, TMS34020A GRAPHICS PROCESSORS

SPVS004D – MARCH 1990 – REVISED NOVEMBER 1993

## pin assignments – PCM quad flat package

PIN NO.	FUNCTION	PIN NO.	FUNCTION	PIN NO.	FUNCTION	PIN NO.	FUNCTION
1	V <sub>SS</sub>	37	V <sub>SS</sub>	73	V <sub>SS</sub>	109	V <sub>SS</sub>
2	V <sub>CC</sub>	38	HCS	74	V <sub>CC</sub>	110	V <sub>CC</sub>
3	CAS3	39	HA31	75	LAD0	111	LAD29
4	CAS2	40	HA30	76	LAD16	112	LAD14
5	CAS1	41	HA29	77	LAD1	113	LAD30
6	CAS0	42	HA28	78	LAD17	114	LAD15
7	V <sub>CC</sub>	43	HA27	79	LAD2	115	LAD31
8	RAS	44	HA26	80	LAD18	116	SCLK
9	V <sub>SS</sub>	45	HA25	81	V <sub>SS</sub>	117	RCA12
10	R0	46	HA24	82	LAD3	118	RCA11
11	R1	47	HA23	83	LAD19	119	RCA10
12	HOE	48	HA22	84	V <sub>CC</sub>	120	RCA9
13	HOST	49	HA21	85	LAD4	121	RCA8
14	HRDY	50	HA20	86	LAD20	122	RCA7
15	HINT	51	HA19	87	LAD5	123	RCA6
16	EMU3	52	HA18	88	LAD21	124	RCA5
17	LCLK1	53	HA17	89	LAD6	125	V <sub>CC</sub>
18	LCLK2	54	V <sub>SS</sub>	90	LAD22	126	V <sub>SS</sub>
19	EMU1	55	V <sub>SS</sub>	91	LAD7	127	RCA4
20	EMU0	56	HA16	92	LAD23	128	RCA3
21	EMU2	57	HA15	93	V <sub>SS</sub>	129	RCA2
22	G1	58	HA14	94	V <sub>SS</sub>	130	RCA1
23	RESET	59	HA13	95	LAD8	131	RCA0
24	LINT2	60	HA12	96	LAD24	132	SF
25	LINT1	61	HA11	97	LAD9	133	TR/QE
26	CAMD	62	HA10	98	LAD25	134	VS <sub>SYNC</sub>
27	BUSFLT	63	HA9	99	LAD10	135	HS <sub>SYNC</sub>
28	SIZE16	64	HA8	100	LAD26	136	CBLNK/VBLNK
29	PGMD	65	HA7	101	LAD11	137	CS <sub>SYNC</sub> /HBLNK
30	LRDY	66	HA6	102	LAD27	138	V <sub>SS</sub>
31	V <sub>CC</sub>	67	HA5	103	V <sub>CC</sub>	139	V <sub>SS</sub>
32	V <sub>CC</sub>	68	HBS3	104	LAD12	140	ALTCH
33	VCLK	69	HBS2	105	LAD28	141	DDIN
34	CLKIN	70	HBS1	106	V <sub>SS</sub>	142	DDOUT
35	HWRITE	71	HBS0	107	LAD13	143	WE
36	HREAD	72	V <sub>SS</sub>	108	V <sub>SS</sub>	144	V <sub>SS</sub>



Terminal Functions

LOCAL MEMORY INTERFACE		
NAME	I/O	DESCRIPTION
$\overline{\text{ALTCH}}$	O	<b>Address latch.</b> The high-to-low transitions of $\overline{\text{ALTCH}}$ can be used to capture the address and status present of the LAD signals. A transparent latch (such as a 74ALS373) maintains the current address and status as long as $\overline{\text{ALTCH}}$ remains low.
BUSFLT	I	<b>Bus fault.</b> External logic asserts BUSFLT high to the TMS34020 to indicate that an error or fault has occurred on the current bus cycle. BUSFLT is also used with LRDY to generate externally requested bus cycle retries so that the entire memory address is presented again on the LAD pins. In emulation mode, BUSFLT is used for write-protecting mapped memory (by disabling CAS outputs for the current cycle).
DDIN	O	<b>Data bus direction in enable.</b> This active-high output is used to drive the active-high output-enables on bidirectional transceivers (such as the 74ALS623). The transceivers buffer data input and output on the LAD0–LAD31 pins when the TMS34020 is interfaced to several memories.
$\overline{\text{DDOUT}}$	O	<b>Data bus direction output-enable.</b> This active-low signal drives the active-low output-enables on bidirectional transceivers (such as the 74ALS623). The transceivers buffer data input and output on the LAD0–LAD31 pins.
LAD0–LAD31	I/O	<b>32-bit multiplexed local address/data bus.</b> At the beginning of a memory cycle, the word address is output on LAD4–LAD31 and the cycle status is output on LAD0–LAD3. After the address is presented, LAD0–LAD31 are used for transferring data within the TMS34020 system. LAD0 is the LSB and LAD31 is the MSB.
LRDY	I	<b>Local ready.</b> External circuitry drives this signal low to inhibit the TMS34020 from completing a local-memory cycle it has initiated. While LRDY remains low, the TMS34020 will wait unless the TMS34020 loses bus priority or is given an external REPLY request (through the BUSFLT signal). Wait states are generated in increments of one full LCLK1 cycle. LRDY can be driven low to extend local-memory read and write cycles, VRAM serial-data-register transfer cycles, and DRAM refresh cycles. During internal cycles, the TMS34020 ignores LRDY.
$\overline{\text{PGMD}}$	I	<b>Page mode.</b> The memory decode logic asserts this signal low if the currently addressed memory supports burst (page-mode) accesses. Burst accesses occur as a series of CAS cycles for a single RAS cycle to memory. LRDY is used with BUSFLT to describe the cycle termination status for a memory cycle. $\overline{\text{PGMD}}$ is also used in emulation mode for mapping memory.
SIZE16	I	<b>Bus size.</b> The memory decode logic can pull this signal low if the currently addressed memory or port supports only 16-bit transfers. SIZE16 can also be used to determine which 16 bits of the data bus are used for a data transfer. In emulation mode, SIZE16 is used to select the size of mapped memory.
DRAM AND VRAM CONTROL		
CAMD	I	<b>Column-address mode.</b> This input dynamically shifts the column address on the RCA0–RCA12 bus to allow the mixing of DRAM and VRAM address matrices using the same multiplexed address RCA0–RCA12 signals.
$\overline{\text{CAS0}}-\overline{\text{CAS3}}$	O	<b>4 column-address strobes.</b> The $\overline{\text{CAS}}$ outputs drive the $\overline{\text{CAS}}$ inputs of DRAMs and VRAMs. These signals strobe the column address on RCA0–RCA12 to the memory. The four $\overline{\text{CAS}}$ strobes provide byte-write access to the memory.
$\overline{\text{RAS}}$	O	<b>Row-address strobe.</b> The $\overline{\text{RAS}}$ output drives the $\overline{\text{RAS}}$ inputs of DRAMs and VRAMs. This signal strobes the row address on RCA0–RCA12 to memory.
RCA0–RCA12	O	<b>13 multiplexed row-address/column-address signals.</b> At the beginning of a memory-access cycle, the row address for DRAMs is present on RCA0–RCA12. The row address contains the most significant address bits for the memory. As the cycle progresses, the memory column address is placed on RCA0–RCA12. The addresses that are actually output during row and column times depend on the memory configuration (set by RCM0 and RCM1 in the CONFIG register) and the state of CAMD during the access. RCA0 is the LSB and RCA12 is the MSB.
SF	O	<b>Special-function pin.</b> This is the special-function signal to 1M VRAMs that allows the use of block write, load write mask, load color mask, and write using write mask. This signal is also used to differentiate instructions and addresses for the coprocessor as part of the coprocessor interface.
$\overline{\text{TR/QE}}$	O	<b>Transfer/output-enable.</b> This signal drives the $\overline{\text{TR/QE}}$ input of VRAMs. During a local-memory read cycle, $\overline{\text{TR/QE}}$ functions as an active-low output-enable to gate from memory to LAD0–LAD31. During special VRAM function cycles, $\overline{\text{TR/QE}}$ controls the type of cycle that is performed.
$\overline{\text{WE}}$	O	<b>Write-enable.</b> The active low $\overline{\text{WE}}$ output drives the $\overline{\text{WE}}$ inputs of DRAMs and VRAMs. $\overline{\text{WE}}$ can also be used as the active-low write-enable to static memories and other devices connected to the TMS34020 local interface. During a local-memory read cycle, $\overline{\text{WE}}$ remains inactive high while $\overline{\text{CAS}}$ is strobed active low. During a local-memory write cycle, $\overline{\text{WE}}$ is strobed active low before CAS is. During VRAM serial-data-register transfer cycles, the state of $\overline{\text{WE}}$ at the falling edge of $\overline{\text{RAS}}$ controls the direction of the transfer.

# TMS34020, TMS34020A GRAPHICS PROCESSORS

SPVS004D – MARCH 1990 – REVISED NOVEMBER 1993

## Terminal Functions (Continued)

NAME	I/O	DESCRIPTION
<b>HOST INTERFACE</b>		
HA5–HA31	I	<b>27 host-address input signals.</b> A host can access a long word by placing the address on these lines. HA5–HA31 correspond to the LAD5–LAD31 signals that output the address to the local memory.
HBS0–HBS3	I	<b>4 host byte selects.</b> The byte selects identify which bytes within the long word are being selected.
HCS	I	<b>Host chip select.</b> A host drives this signal low to latch the current host address present on HA5–HA31 and the host byte selects on HBS0–HBS3. This signal also enables host access cycles to the TMS34020 I/O registers or local memory. During the low-to-high transition of RESET, the level on the HCS input determines whether the TMS34020 is halted (HCS is high for host-present mode) or whether it begins executing its reset service routine (HCS is low for self-bootstrap mode).
HDST	O	<b>Host data-latch strobe.</b> The rising edge of this signal latches data from the TMS34020 local address space to the external host data latch on host read accesses. It can be used in conjunction with HRDY to indicate that data is valid in the external data latch.
HINT	O	<b>Host interrupt.</b> This signal allows the TMS34020 to interrupt a host by setting the INTOUT bit in the HSTCTLL I/O register. This signal can also be used to interrupt the host if a BUSFLT or RETRY occurs due to a host-access cycle.
HOE	O	<b>Host data-latch output-enable.</b> This signal enables data from host data latches to the TMS34020 local address space on host-write cycles. HOE can be used in conjunction with HRDY to indicate data has been written to memory from the external data latch.
HRDY	O	<b>Host ready.</b> This signal is normally low and goes high to indicate that the TMS34020 is ready to complete a host-initiated read or write cycle. If the TMS34020 is ready to accept the access request, HRDY is driven high and the host proceeds with the access. A host can use HRDY logically combined with HDST and HOE to determine when the local bus-access cycles have completed.
HREAD	I	<b>Host read strobe.</b> This signal is driven low during a read request from a host processor. This notifies the TMS34020 that the host is requesting access to the I/O registers or to local memory. HREAD should not be asserted at the same time that HWRITE is asserted.
HWRITE	I	<b>Host write strobe.</b> This signal is driven low to indicate a write request by a host processor. This notifies the TMS34020 that a write request is pending. The rising edge of HWRITE is used to indicate that the host has latched data to be written in the external data transceivers. HWRITE should not be asserted at the same time HREAD is asserted.
<b>SYSTEM CONTROL</b>		
CLKIN	I	<b>Clock input.</b> This system input clock generates the LCLK1 and LCLK2 outputs, to which all processor functions in the TMS34020 are synchronous. A separate asynchronous input clock (VCLK) controls the video timing and video registers.
LCLK1, LCLK2	O	<b>Local output clocks.</b> These two clocks are 90 degrees out of phase with each other. They provide convenient synchronous control of external circuitry to the internal timing. All signals output from the TMS34020 (except the CRT timing signals) are synchronous to these clocks.
LINT1, LINT2	I	<b>Local interrupt requests.</b> Interrupts from external devices are transmitted to the TMS34020 on LINT1 and LINT2. Each local interrupt signal activates the request for one of two interrupt-request levels. An external device generates an interrupt request by driving the appropriate interrupt-request pin to its active-low state. The signal should remain low until the TMS34020 recognizes it. These signals can be applied asynchronously to the TMS34020; they are synchronized internally before use.
RESET	I	<b>System reset.</b> During normal operation, RESET is driven low to reset the TMS34020. When RESET is asserted low, the TMS34020's internal registers are set to an initial known state and all output and bidirectional pins are driven either to inactive levels or to the high-impedance state. The TMS34020's behavior following reset depends on the level of the HCS input just before the low-to-high transition of RESET. If HCS is low, the TMS34020 begins executing the instructions pointed to by the reset vector. If HCS is high, the TMS34020 is halted until a host processor writes a 0 to the HLT bit in the HSTCTLL register.

Terminal Functions (Continued)

NAME	I/O	DESCRIPTION															
<b>POWER</b>																	
$V_{CC}^{\dagger}$	I	Nominal 5-volt power supply inputs. 9 pins.															
$V_{SS}^{\dagger}$	I	Electrical ground inputs. 17 pins.															
<b>EMULATION CONTROL</b>																	
EMU0–EMU2	I	Emulation pins 0–2.															
EMU3	O	Emulation pin 3.															
<b>MULTIPROCESSOR INTERFACE</b>																	
$\overline{GI}$	I	<b>Bus grant input.</b> External bus arbitration logic drives $\overline{GI}$ low to enable the TMS34020 to gain access to the local-memory bus. The TMS34020 must release the bus if $\overline{GI}$ is high so that another device can access the bus.															
$\overline{R1}, \overline{R0}$	O	<p><b>Bus request and control.</b> These two signals indicate a request for use of the bus in a multiprocessor system; they are decoded as shown below:</p> <table border="1" style="margin-left: auto; margin-right: auto;"> <thead> <tr> <th><math>\overline{R1}</math></th> <th><math>\overline{R0}</math></th> <th>Bus Request Type</th> </tr> </thead> <tbody> <tr> <td>0</td> <td>0</td> <td>High-priority bus request</td> </tr> <tr> <td>0</td> <td>1</td> <td>Bus-cycle termination</td> </tr> <tr> <td>1</td> <td>0</td> <td>Low-priority bus request</td> </tr> <tr> <td>1</td> <td>1</td> <td>No bus request pending</td> </tr> </tbody> </table> <p>A high-priority bus request provides for VRAM serial-data-register transfer cycles (midline or blanked), DRAM refresh (when 12 or more refresh cycles are pending), or a host-initiated access. The external arbitration logic should grant the request as soon as possible by asserting <math>\overline{GI}</math> low.</p> <p>A low-priority bus request is used to provide for CPU-requested access and DRAM refresh (when less than 12 refresh cycles are pending).</p> <p>Bus-cycle termination status is provided so that the arbitration logic can determine that the device currently accessing the bus is completing an access and other devices can compete for the next bus cycle. A <i>no bus request pending</i> status is output when the currently active device does not require the bus on subsequent cycles.</p>	$\overline{R1}$	$\overline{R0}$	Bus Request Type	0	0	High-priority bus request	0	1	Bus-cycle termination	1	0	Low-priority bus request	1	1	No bus request pending
$\overline{R1}$	$\overline{R0}$	Bus Request Type															
0	0	High-priority bus request															
0	1	Bus-cycle termination															
1	0	Low-priority bus request															
1	1	No bus request pending															
<b>VIDEO INTERFACE</b>																	
$\overline{CBLNK} / \overline{VBLNK}$	O	<p><b>Composite blanking/vertical blanking.</b> You can program this signal to select one of two blanking functions:</p> <p><b>Composite blanking</b> for blanking the display during both horizontal and vertical retrace periods in <i>composite-sync-video mode</i>.</p> <p><b>Vertical blanking</b> for blanking the display during vertical retrace in <i>separate-sync-video mode</i>.</p> <p>Immediately following reset, this signal is configured as a <math>\overline{CBLNK}</math> output.</p>															
$\overline{CSYNC} / \overline{HBLNK}$	I/O	<p><b>Composite sync/horizontal blanking.</b> You can program this signal to select one of two functions.</p> <p><b>Composite sync</b> (either input or output as set by a control bit in the DPYCTL register) in <i>composite-sync-video mode</i>:</p> <p><i>Input:</i> Extracts <math>\overline{HSYNC}</math> and <math>\overline{VSYNC}</math> from externally generated horizontal sync pulses.</p> <p><i>Output:</i> Generates active-low composite-sync pulses from either externally generated <math>\overline{HSYNC}</math> and <math>\overline{VSYNC}</math> signals or signals generated by the TMS34020's on-chip video timers.</p> <p><b>Horizontal blank</b> (output only) for blanking the display during horizontal retrace in <i>separate-sync-video mode</i>.</p> <p>Immediately following reset, this signal is configured as a <math>\overline{CSYNC}</math> input.</p>															

<sup>†</sup> For proper TMS34020 operation, all  $V_{CC}$  and  $V_{SS}$  pins must be connected externally.

# TMS34020, TMS34020A GRAPHICS PROCESSORS

SPVS004D – MARCH 1990 – REVISED NOVEMBER 1993

## Terminal Functions (Continued)

VIDEO INTERFACE		
NAME	I/O	DESCRIPTION
$\overline{\text{HSYNC}}$	I/O	<p><b>Horizontal sync.</b> <math>\overline{\text{HSYNC}}</math> is the horizontal sync signal that controls external video circuitry. You can program this signal to be either an input or an output by modifying a control bit in the DPYCTL register.</p> <p>As an <b>output</b>, <math>\overline{\text{HSYNC}}</math> is the active-low horizontal-sync signal generated by the TMS34020's on-chip video timers.</p> <p>As an <b>input</b>, <math>\overline{\text{HSYNC}}</math> synchronizes the TMS34020 video-control registers to externally generated horizontal-sync pulses. The actual synchronization can be programmed to begin at any VCLK cycle; this allows for any external pipelining of signals.</p> <p>Immediately following reset, <math>\overline{\text{HSYNC}}</math> is configured as an input.</p>
SCLK	I	<p><b>Serial data clock.</b> This signal is the same as the signal that drives VRAM serial data registers. This allows the TMS34020 to track the VRAM serial data register count, providing serial-register-transfer and midline-reload cycles. (SCLK can be asynchronous to VCLK; however, it typically has a frequency that is a multiple of the VCLK frequency).</p>
VCLK	I	<p><b>Video clock.</b> This clock is derived from a multiple of the video system's dotclock and is used internally to drive the video timing logic.</p>
$\overline{\text{VSYNC}}$	I/O	<p><b>Vertical sync.</b> <math>\overline{\text{VSYNC}}</math> is the vertical sync signal that controls external video circuitry. You can program this signal to be either an input or an output by modifying a control bit in the DPYCTL register.</p> <p>As an <b>output</b>, <math>\overline{\text{VSYNC}}</math> is the active-low vertical-sync signal generated by the TMS34020's on-chip video timers.</p> <p>As an <b>input</b>, <math>\overline{\text{VSYNC}}</math> synchronizes the TMS34020 video-control registers to externally generated vertical-sync pulses. The actual synchronization can be programmed to begin at any horizontal line; this allows for any external pipelining of signals.</p> <p>Immediately following reset, <math>\overline{\text{VSYNC}}</math> is configured as an input.</p>



functional block diagram

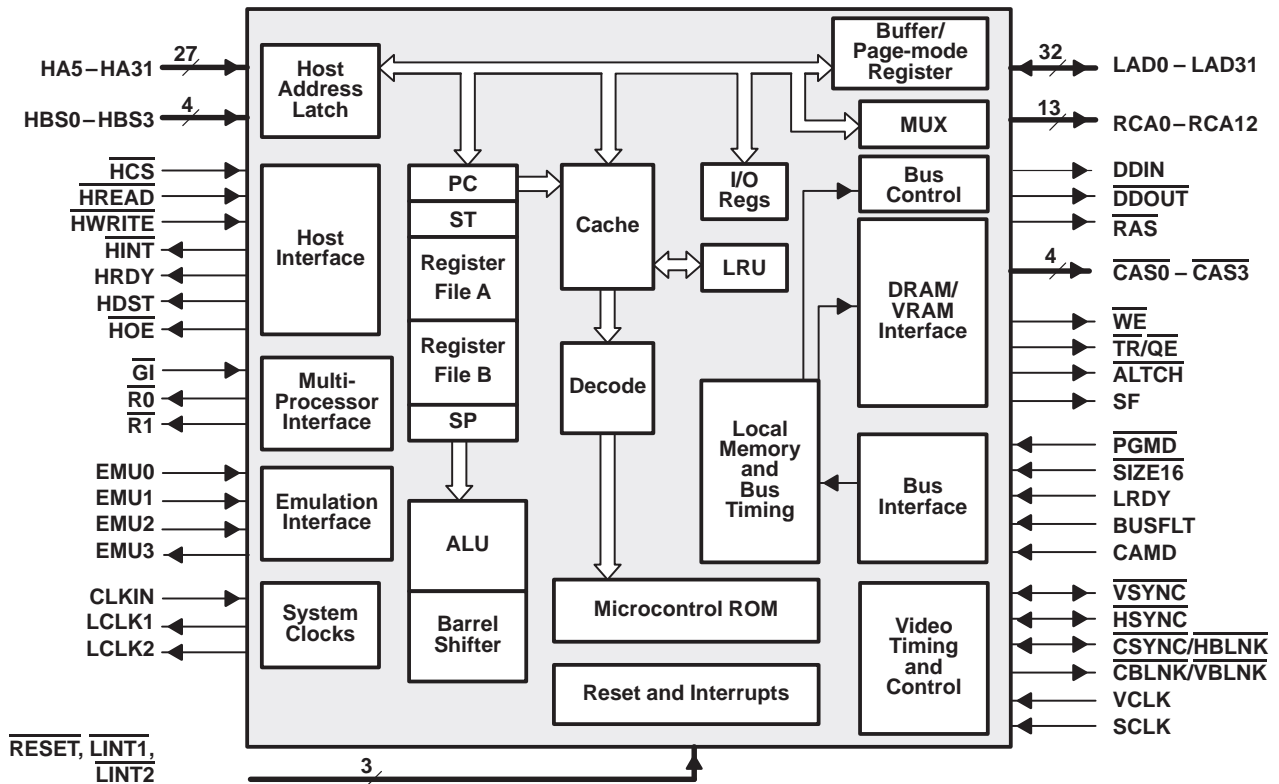

architecture (continued)

register files

Boolean, arithmetic, pixel-processing, byte, and field-move instructions operate on data within the general-purpose register files. The TMS34020 contains two register files of fifteen 32-bit registers and a system stack pointer (SP). The SP is addressed in both register file A and register file B as a sixteenth register. Transfers between registers and memory are facilitated via a complete set of field-move instructions with selectable field sizes.

The 15 general-purpose registers in register file A are used for high-level language support and assembly-language programming. The 15 registers in register file B are dedicated to special functions during PixBits and other pixel operations but can be used as general-purpose registers at other times.

stack pointer (SP)

The stack pointer is a dedicated 32-bit internal register that points to the top of the system stack.

program counter (PC)

The TMS34020's 32-bit program counter register points to the next instruction-stream word to be fetched. Since instruction words are aligned to 16-bit boundaries, the four LSBs of the PC are always zero.

instruction cache

An on-chip cache contains 512 bytes of RAM and provides unimpeded access to instructions. The cache operates automatically and is transparent to software. The cache is divided into four 128-byte segments. Associated with each segment is a 22-bit segment start address register (SSA) to identify the addresses in

# TMS34020, TMS34020A

## GRAPHICS PROCESSORS

SPVS004D – MARCH 1990 – REVISED NOVEMBER 1993

---

memory corresponding to the current contents of the cache segment. Each cache segment is further partitioned into eight subsegments of four long words (32 bits) each. Each subsegment has associated with it a present (P) flag to indicate whether the subsegment contains valid data.

The cache is loaded only when an instruction requested by the execution section of the TMS34020 is not already contained within the cache. A least-recently-used (LRU) algorithm determines which of the four segments of the cache is overwritten with new data. For this purpose, an internal four-by-two LRU stack keeps track of cache usage. Although the cache is loaded so as to always fill a subsegment completely, not all eight subsegments within a segment are necessarily filled (this is dependent upon the instruction stream).

### status register

The status register (ST) is a special-purpose 32-bit register dedicated to status codes set by the results of implicit and explicit compare operations and parameters used to specify the length and behavior of fields 0 and 1.

In addition, during an interrupt, the IX bit in the ST placed on the stack provides indication that execution of an interruptible instruction (PIXBLT, FILL or LINE) was halted to service the interrupt.

The single-step bit causes a TRAP to the single-step vector (located at address FFFF FBE0h) after the execution of one instruction when the bit is set high. Normal program execution occurs when the bit is set low.

### fields, bytes, words, long words, pixels, and pixel arrays

The TMS34020 outputs a 28-bit address on LAD4–LAD31, which is valid at the falling edge of  $\overline{\text{ALTCH}}$ . The most significant 27 bits (LAD5–LAD31) define a 32-bit long word of physical memory; logically, however, the TMS34020 views memory data as fields addressable at the bit level. The least significant bit of the 28-bit address (LAD4) is used to select the odd or even word when accessing 16-bit memories (indicated by  $\overline{\text{SIZE16}}$  asserted low). Primitive data types supported by the TMS34020 include bytes, words, long words, pixels, two independent fields of from 1 to 32 bits, and user-defined pixel arrays.

Words and long words, respectively, refer to 16- and 32-bit values that are aligned on 32-bit boundaries.

The two independent fields are referenced as field 0 and field 1. The attributes of these fields (field size and sign extension within a register) are defined in the status register as FS0, FE0, FS1, and FE1. Fields 0 and 1 are specified independently to be signed or unsigned and from 1 to 32 bits in length. Bytes are special 8-bit cases of the field data type, while pixels are 1, 2, 4, 8, 16, or 32 bits in length. In general, fields (including bytes) can start and terminate on arbitrary bit boundaries; however, pixels must pack evenly into 32-bit long words.

### pixel operations

Pixel arrays are two-dimensional data types of user-defined width, length, pixel depth (number of bits per pixel), and pitch (distance between rows). A pixel or pixel array can be accessed by means of either its memory address or its XY coordinates. Transfers of individual pixels or pixel blocks are influenced by the pixel-processing, transparency, window-checking, plane-masking, pixel-masking, or corner-adjustment operations selected. For further information, see the *TMS34020 User's Guide*, literature number SPVU019.

### transparency

Transparency is a mechanism that allows surrounding pixels in an array to be specified as invisible. This is useful for ensuring that only the object and not the rectangle surrounding it are written to the display. The TMS34020 provides four transparency modes:

- No transparency.
- Transparency on result equal zero.
- Transparency on source equal COLOR0.
- Transparency on destination equal COLOR0.

Refer to the *TMS34020 User's Guide* for more information.

## I/O registers

The TMS34020 contains an on-chip block of sixty-four 16-bit locations (mapped into the TMS34020's memory address space) that are used for I/O control registers. Eight of these are used by the host interface logic and are not available to the user. Forty-seven I/O registers control parameters necessary to configure the operation and report status of the following interfaces:

- Host interface.
- Local memory.
- Video timing.
- Screen refresh.
- External interrupts.
- Internal interrupts.

## host interface registers

The host interface registers (HSTDATA, HSTADRL, HSTADRH, HSTCTLL, and HSTCTLH) are provided to facilitate communications between the TMS34020 and a host processor and maintain compatibility with the TMS34010. The registers are mapped into five of the I/O locations accessible to the TMS34020.

Two of these registers (HSTCTLL and HSTCTLH) are used to provide control by the host. This control consists of passing of interrupt requests, flushing the instruction cache, halting the TMS34020, transmitting a nonmaskable interrupt request to the TMS34020, enabling emulation interrupts, and setting host-access modes and configurations.

The other three registers are simple read/write registers to allow the TMS34020 software to leave addresses for the host at a known location and allow compatibility with some TMS34010 software.

## memory interface control registers

Some of the I/O registers are used to control various local memory interface functions, including:

- Frequency of DRAM refresh cycles.
- Masking (read/write protection) of individual color planes.
- DRAM row/column addressing configuration.
- Accessing mode (big endian/little endian).
- Bus fault and retry recovery.

## video timing and screen refresh

Twenty-eight I/O registers are dedicated to video timing and screen refresh functions. The TMS34020 can be configured to drive composite sync or separate sync displays.

In composite mode, the TMS34020 can be set to extract  $\overline{VS\text{YNC}}$  and  $\overline{HS\text{YNC}}$  from an external  $\overline{CS\text{YNC}}$ , or it can be used to generate  $\overline{CS\text{YNC}}$  from separate  $\overline{VS\text{YNC}}$  and  $\overline{HS\text{YNC}}$  inputs. Internally, the TMS34020 can be set to preset the horizontal and vertical counts on receipt of an external sync signal. This allows compensation for any combination of internal and external delays that occur in the video synchronization process. The HCOUNT register is loaded from SETHCNT by an external  $\overline{HS\text{YNC}}$ , VCOUNT is loaded from SETVCNT on an external  $\overline{VS\text{YNC}}$ , and an external  $\overline{CS\text{YNC}}$  loads both HCOUNT and VCOUNT from SETHCNT and SETVCNT, respectively.

The TMS34020 directly supports multiport video RAMs (VRAMs) by generating the serial data register transfer cycles necessary to refresh the display. The memory locations from which the display information is taken, as well as the number of horizontal scan lines displayed between serial data register transfer cycles, are programmable.

# TMS34020, TMS34020A

## GRAPHICS PROCESSORS

SPVS004D – MARCH 1990 – REVISED NOVEMBER 1993

---

The TMS34020 supports various display resolutions and either interlaced or noninterlaced video. The TMS34020 can optionally be programmed to synchronize to externally generated sync signals so that images created by the TMS34020 may be superimposed upon images created externally. The external sync mode can also be used to synchronize the video signals generated by two or more TMS34020s in a multiple-TMS34020 graphics system.

### CPU control registers

Five of the I/O registers (CONVDP, CONVMP, CONVSP, CONTROL, and PSIZE) provide CPU control to configure the TMS34020 for operation with specific characteristics. These characteristics include pitches for pixel transfers, window-checking mode, Boolean or arithmetic pixel-processing operation, transparency mode, PixBlt direction control, and pixel size.

### interrupt interface registers

Two dedicated I/O registers (INTENB and INTPEND) monitor and mask interrupt requests to the TMS34020, including two externally generated interrupts and three internally generated interrupts. An internal interrupt request can be generated on one of the following conditions.

- Window violation: an attempt has been made to write a pixel to a location inside or outside a specified window boundary.
- Host interrupt: the host processor has set the interrupt-request bit in the host control register.
- Display interrupt: a specified horizontal line in the frame has been displayed on the screen.
- Bus fault.
- Single-step emulator.

A nonmaskable interrupt occurs when the host processor sets a control bit in the host interface register (NMI in HSTCTLH). The host-initiated interrupt is associated with a mode bit (NMIM in HSTCTLH) that enables and disables saving of the processor state on the stack when the interrupt occurs. This is useful if the host wishes to use the host interrupt before releasing the TMS34020 to execute instructions (i.e., before the stack pointer is initialized). The TMS34020 reset function is controlled by a dedicated pin.

### memory controller/local memory interface

The memory controller manages the TMS34020's interface to the local memory and automatically performs the bit alignment and masking necessary to access data located at arbitrary bit boundaries within memory. The memory controller operates autonomously with respect to the CPU. It has a write queue one field (1 to 32 bits) deep that permits it to complete the memory cycles necessary to insert a field into memory without delaying the execution of subsequent instructions. Only when a second memory operation is required before completion of the first operation is the TMS34020 forced to defer execution of the subsequent instruction.

The TMS34020 directly interfaces to standard dynamic RAMs and, in particular, to standard video RAMs such as the TMS44C251 multiport VRAMs. The TMS34020 memory interface consists of the local address/data bus (LAD), the DRAM row/column address (RCA) bus, and associated control signals. The currently selected word address (28 bits) and status (4 bits) are multiplexed with data on the LAD bus. The RCA bus allows direct connection to address/address multiplexed DRAMs from 64K to 16M. Refresh for DRAMs is supported by  $\overline{\text{CAS}}$ -before- $\overline{\text{RAS}}$  refresh cycles.

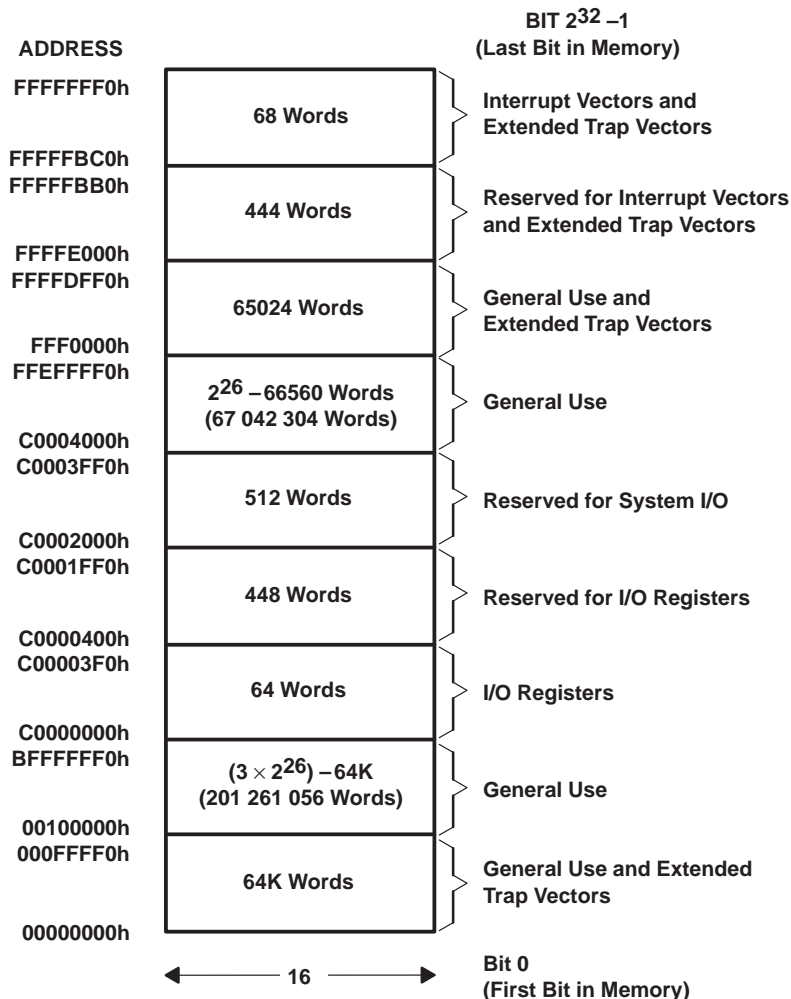

**Figure 1. Memory Map**

## reset

Reset puts the TMS34020 into a known initial state. This state is entered when the input signal at the  $\overline{\text{RESET}}$  pin is asserted low. While  $\overline{\text{RESET}}$  remains asserted, all outputs are in a known state, no DRAM refresh cycles take place, and no screen refresh cycles are performed.

The state of the  $\overline{\text{HCS}}$  input on the CLKIN cycle before the low-to-high transition of the  $\overline{\text{RESET}}$  signal determines whether the TMS34020 will be halted or begin executing instructions. The TMS34020 may be in one of two modes, host-present or self-bootstrap mode.

1. Host-Present Mode. If  $\overline{\text{HCS}}$  is high at the end of reset, TMS34020 instruction execution halts and remains halted until the host clears the HLT (halt) bit in HSTCTLH (host control register). Following reset, the  $\overline{\text{RAS}}$  cycles required to initialize the dynamic RAMs are performed automatically by the GSP memory control logic. The host may request a memory access after the eight  $\overline{\text{RAS}}$  initialization cycles have completed. The TMS34020 automatically performs DRAM refresh cycles at regular intervals; although the TMS34020 remains halted until the host clears the HLT bit. Only then does TMS34020 fetch the level-0 vector address from location FFFF FE0h and begin executing the reset service routine.
2. Self-Bootstrap Mode. If  $\overline{\text{HCS}}$  is low at the end of reset, the TMS34020 first performs eight refresh cycles to initialize the DRAMs. Immediately following the eight refresh cycles, the GSP fetches the level-0 vector address from location FFFF FE0h, and begins executing the reset service routine.

# TMS34020, TMS34020A GRAPHICS PROCESSORS

SPVS004D – MARCH 1990 – REVISED NOVEMBER 1993

---

At the time the TMS34020 fetches the level-0 vector address (the reset vector), the least significant four bits (bit-address part) are used to load configuration data that establishes the initial condition of the *big endian/little endian* mode and the current RCA bus configuration bits in the CONFIG register as described in the I/O register section.

Unlike other interrupts and software traps, reset does not save the previous ST or PC values (this can also occur on host-initiated nonmaskable interrupts if the NMIM bit in HSTCTLH is set to a 1), since the value of the stack pointer just before a reset is generally not valid, and saving these values on the stack could contaminate valid memory locations. A TRAP 0 instruction, which uses the same vector address as reset, similarly does not save the ST or PC values.

## asserting reset

A reset is initiated by asserting the  $\overline{\text{RESET}}$  input pin to its active-low level. To reset the TMS34020 at power up,  $\overline{\text{RESET}}$  must remain low for a minimum of 40 local clock periods (LCLK1 and LCLK2) after power levels have become stable. At times other than power up, the TMS34020 may be reset by holding  $\overline{\text{RESET}}$  low for a minimum of four local clock periods; the GSP will enter an internal reset state for 34 local clock cycles. While in the internal reset state and  $\overline{\text{RESET}}$  is high, memory refresh cycles occur.

## reset and multiprocessor synchronization

The synchronization of multiple TMS34020s sharing a local memory is done using the  $\overline{\text{RESET}}$  input. In systems where the multiprocessor interface is used to control the access to a common memory, the processors must be synchronized. Synchronization is achieved by taking  $\overline{\text{RESET}}$  high within a specific interval relative to CLKIN. This may be done by using CLKIN to clock  $\overline{\text{RESET}}$  as received by the TMS34020s. All TMS34020s to be synchronized should use the same CLKIN and  $\overline{\text{RESET}}$  inputs. All of the local memory and bus control signals should be connected in parallel (without buffers) between the processors. After power up, the processors are not necessarily synchronized with respect to the particular quarter cycle in progress. The rising edge of  $\overline{\text{RESET}}$  is used to set the TMS34020 to a particular quarter cycle by adding Q1 cycles. All TMS34020s in a multiprocessor environment operate on the same quarter cycle within 10 quarter cycles after the rising edge of  $\overline{\text{RESET}}$ .

## reset and DRAM/VRAM initialization

The TMS34020 drives its  $\overline{\text{RAS}}$  signal inactive (high) as long as  $\overline{\text{RESET}}$  remains low. The specifications for certain DRAM and VRAM devices require that the  $\overline{\text{RAS}}$  signal be driven inactive for 1 millisecond after power is stable to provide the proper conditions for the DRAMs. Typically, eight  $\overline{\text{RAS}}$  cycles are also required to initialize the DRAMs for proper operation. In general, holding  $\overline{\text{RESET}}$  low for  $t$  microseconds ensures that  $\overline{\text{RAS}}$  remains high initially for  $t - (10t_Q)$  microseconds. The TMS34020 memory controller automatically inserts the required eight  $\overline{\text{RAS}}$  cycles after all resets (after power up or after the internal reset state) by issuing  $\overline{\text{CAS}}$ -before- $\overline{\text{RAS}}$  refresh cycles before it allows the CPU access to memory. A host must delay requests to memory until the initialization cycles have had sufficient time to complete. Immediately following reset, the TMS34020 is set to perform a refresh sequence every eight cycles.

At times other than power up, to maintain the memory in DRAMs and do a reset, the  $\overline{\text{RESET}}$  pulse must not exceed the maximum refresh interval of the DRAMs minus the time for the TMS34020 to refresh the memories. On reset, the TMS34020 is set to do a refresh cycle every eight local clock periods. A 32-MHz (CLKIN) system with one (refresh) bank of D/VRAM would be completely refreshed in one-sixteenth of the total memory refresh interval. The reset pulse then should not exceed about fifteen-sixteenths of the total refresh interval required by the DRAMs to maintain memory integrity.

If the  $\overline{\text{RESET}}$  signal remains low longer than the maximum refresh interval specified for the memory, the previous contents of the local memory may not be valid after the reset.

**initial state following reset**

While the  $\overline{\text{RESET}}$  pin is asserted low (or while in the internal reset state), the TMS34020's output and bidirectional pins are forced to the states below.

INITIAL STATE OF PINS FOLLOWING A RESET (WITH $\overline{\text{GI}}$ LOW)		
OUTPUTS DRIVEN HIGH	OUTPUTS DRIVEN LOW	BIDIRECTIONAL DRIVEN TO HIGH-IMPEDANCE
$\overline{\text{RAS}}$	$\overline{\text{HRDY}}$	$\overline{\text{VSYNC}}$
$\overline{\text{CAS0}}-\overline{\text{CAS3}}$	$\overline{\text{CBLNK}}/\overline{\text{VBLNK}}$	$\overline{\text{HSYNC}}$
$\overline{\text{WE}}$	$\overline{\text{DDIN}}$	$\overline{\text{CSYNC}}/\overline{\text{HBLNK}}$
$\overline{\text{TR}}/\overline{\text{QE}}$		$\overline{\text{LAD0}}-\overline{\text{LAD31}}$
$\overline{\text{DDOUT}}$		
$\overline{\text{ALTCH}}$		
$\overline{\text{HINT}}$		
$\overline{\text{R0}}$		
$\overline{\text{R1}}$		
$\overline{\text{HOE}}$		
$\overline{\text{HDST}}$		
$\overline{\text{EMU3}}$		
$\overline{\text{RCA0}}-\overline{\text{RCA12}}$		
$\overline{\text{SF}}$		

NOTE: If  $\overline{\text{GI}}$  is high, then all  $\overline{\text{GI}}$ -controlled pins will be in the high-impedance state. The  $\overline{\text{GI}}$ -controlled pins are  $\overline{\text{RAS}}$ ,  $\overline{\text{CAS0}}-\overline{\text{CAS3}}$ ,  $\overline{\text{WE}}$ ,  $\overline{\text{TR}}/\overline{\text{QE}}$ ,  $\overline{\text{DDOUT}}$ ,  $\overline{\text{DDIN}}$ ,  $\overline{\text{ALTCH}}$ ,  $\overline{\text{HOE}}$ ,  $\overline{\text{HDST}}$ ,  $\overline{\text{RCA0}}-\overline{\text{RCA12}}$ ,  $\overline{\text{LAD0}}-\overline{\text{LAD31}}$ , and  $\overline{\text{SF}}$ .

Immediately following reset, all I/O registers are cleared (set to 0000), with the exception of the HLT bit in the HSTCTLH register. The HLT bit is set to 1 if the  $\overline{\text{HCS}}$  pin is high just prior to the low-to-high transition of  $\overline{\text{RESET}}$ ; otherwise, it is set to 0.

Just prior to the execution of the first instruction in the reset routine, the TMS34020's internal registers are in the following states:

- General-purpose register files A and B are uninitialized.
- The ST is set to 0000 0010h.
- The PC contains the most significant 28 bits of the vector fetched from memory address FFFF FFE0h (the least significant four bits of the PC are set to zero).
- The BEN bit in the I/O register CONFIG is set to the least significant bit read from the vector fetched from memory address FFFF FFE0h.
- The CBP, RCM0, and RCM1 bits in the I/O register CONFIG are set to the corresponding bits read from the vector fetched from memory address FFFF FFE0h. The configuration-byte-protect bit (CBP) can be set high to prevent further modification of the lower eight bits of the I/O register CONFIG.

The state of the instruction cache at this time is as follows:

- The SSA (segment start address) registers are uninitialized.
- The LRU (least-recently-used) stack is set to the initial sequence 0, 1, 2, 3, where 0 occupies the most-recently-used position and 3 occupies the least-recently-used position.
- All P (present) flags are cleared to 0s.

# TMS34020, TMS34020A GRAPHICS PROCESSORS

SPVS004D – MARCH 1990 – REVISED NOVEMBER 1993

## local memory and DRAM/VRAM interface

The TMS34020 local memory interface consists of an address/data multiplexed bus on which address and data are transmitted. The associated control signals support memory widths of 16 or 32 bits, burst (page-mode) accesses, local-memory wait states, and optional external data bus buffers. The TMS34020 DRAM/VRAM interface consists of an address/address multiplexed bus and the control signals to interface directly to both DRAMs and VRAMs. The local-memory interface and the DRAM/VRAM interface are interrelated and therefore considered together for this description. At the beginning of a typical memory cycle, the address and status of the current cycle are output on the LAD bus, while the row address is output on the row/column address (RCA) bus.  $\overline{\text{ALTCH}}$  and  $\overline{\text{RAS}}$  are used to latch the address/status and row address, respectively, on these two buses. The LAD bus is then used to transfer data to or from the memory while the RCA bus is set to the column address for the memory. LAD31 is the most significant bit of the address or data.

### LAD During the Address Cycle

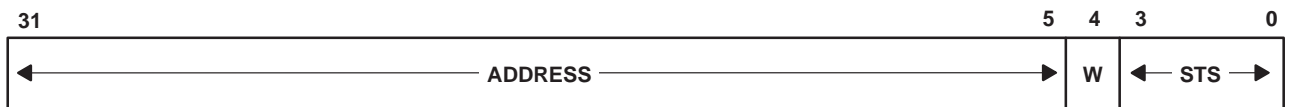

- ADDRESS — Memory address (select for 128M 32-bit long words)
- W = 0 — Access to lower 16-bit word (even-addressed word or 32-bit boundary)
- W = 1 — Access to upper 16-bit word (odd-addressed word)
- STS — Bus cycle status code

The address output on the row/column address (RCA) lines is determined by the row/column mode bits (RCM0 and RCM1 in the I/O register CONFIG) and the state of the column address mode pin (CAMD) during each memory cycle. The CAMD signal is sampled on the internal Q4 clock phase, which allows CAMD to be generated by static logic wired to the local address/data (LAD) bus.

BASIC MEMORY ROW/COLUMN ACCESS MODES					
RCM1	RCM0	VRAM MODE	ADDRS	BANKS	CAMD SUPPORT MATRICES
0	0	64K × N	8	16	64K × 16, 64K × 32, 256K × 16, 256K × 32, 1M × 16, 1M × 32
0	1	256K × N	9	8	256K × 16, 256K × 32, 1M × 16, 1M × 32, 4M × 32
1	0	1M × N	10	4	1M × 16, 1M × 32, 4M × 16, 4M × 32
1	1	4M × N	11	2	4M × 16, 4M × 32, 16M × 32

VRAM Mode = basic size of VRAM addressing supported with CAMD = 0.

AddrS = number of RCA signals required to provide row/column addressing.

Banks = number of possible interleaved 32-bit wide memory spaces.

CAMD Support = possible sizes and configurations of DRAMs that may be supported within the basic VRAM mode.



The following table illustrates the actual logical address bits output on each of the RCA lines during row and column intervals for each of the four VRAM modes and states of CAMD:

RCA BIT	ROW TIME				COLUMN TIME				
	64K	256K	1M	4M	CAMD = 0	CAMD = 1			
	64K	256K	1M	4M		64K	256K	1M	4M
12	24	25	26	27	16	23	26	15	28
11	23	24	25	26	15	22	14	14	14
10	22	23	24	25	14	13	13	13	13
9	21	22	23	24	13	12	12	12	12
8	20	21	22	23	12	11	11	11	11
7	19	20	21	22	11	10	10	10	10
6	18	19	20	21	10	9	9	9	9
5	17	18	19	20	9	8	8	8	8
4	16	17	18	19	8	7	7	7	7
3	15	16	17	18	7	6	6	6	6
2	14	15	16	17	6	5	5	5	5
1	13	14	15	16	5	4	4	4	4
0	12	13	14	15	4	4	4	4	16

In 64K mode with CAMD=0, any eight adjacent RCA0–RCA12 pins output 16 contiguous logical address bits. The eight most significant addresses are output during row-address time, while the least significant addresses are output during column-address time. Logical addresses 12 through 16 are output twice during a memory cycle (during both RAS and CAS falling edges) but at different pins. This allows a variety of VRAM memory organizations and decoding schemes to be used. When CAMD = 1, the addresses output during column-address time are changed such that a new logical address mapping occurs, allowing connection of the RCA signals directly to 256K or 1M DRAMs.

Similarly, for each of the other VRAM modes, direct connection is provided for other DRAM modes requiring larger matrices than the configuration mode. The following table gives examples of the connections using this feature.

CONNECTIONS TO RCA FOR CAMD = 1						
RCA	64K	256K	1M	4M	4M	
12		1M × 32		4M × 32	4M × 32	16M × 32
11		1M × 16	1M × 32	4M × 32	4M × NN	16M × 32
10	256K × 32	1M × 32	1M × NN	4M × 32	4M × NN	16M × 32
9	256K × NN	1M × NN	1M × NN	4M × 32	4M × NN	16M × 32
8	256K × NN	1M × NN	1M × NN	4M × 32	4M × NN	16M × 32
7	256K × NN	1M × NN	1M × NN	4M × 32	4M × NN	16M × 32
6	256K × NN	1M × NN	1M × NN	4M × 32	4M × NN	16M × 32
5	256K × NN	1M × NN	1M × NN	4M × 32	4M × NN	16M × 32
4	256K × NN	1M × NN	1M × NN	4M × 32	4M × NN	16M × 32
3	256K × NN	1M × NN	1M × NN	4M × 32	4M × NN	16M × 32
2	256K × NN	1M × NN	1M × NN	4M × 32	4M × NN	16M × 32
1	256K × 16	1M × 16	1M × 16		4M × 16	
0						16M × 32

NOTE: NN is used for either 16-bit (× 16) or 32-bit (× 32) memory connections.

# TMS34020, TMS34020A GRAPHICS PROCESSORS

SPVS004D – MARCH 1990 – REVISED NOVEMBER 1993

## status codes

Status codes are output on LAD0–LAD3 at the time of the falling edge of  $\overline{\text{ALTCH}}$  and may be used to determine the type of cycle that is being initiated. The following table lists the codes and their respective meanings.

CODE	STATUS	TYPE
0000	Coprocessor Code	Other (00XX)
0001	Emulator Operation	
0010	Host Cycle	
0011	DRAM Refresh	
0100	Video-generated DRAM Serial Register Transfer	VRAM (01XX)
0101	CPU-generated VRAM Serial Register Transfer	
0110	Write Mask Load	
0111	Color Latch Load	
1000	Data Access	CPU (1XXX)
1001	Cache Fill	
1010	Instruction Fetch	
1011	Interrupt Vector Fetch	
1100	Bus Locked Operation	
1101	Pixel Operation	
1110	Block Write	
1111	Reserved	

## dynamic bus sizing

The TMS34020 supports dynamic bus sizing between 16 and 32 bits on any local memory access. Any port/memory that is only 16 bits wide must assert  $\overline{\text{SIZE16}}$  low during Q1 (to be valid at the start of Q2) of the bus cycle accessing the even memory word (LAD4 = 0) corresponding to its address. The TMS34020 then performs another memory access to the next 16-bit (odd) word in memory. The TMS34020 samples the  $\overline{\text{SIZE16}}$  pin at the start of Q2 in the second cycle (access to odd word address) to determine to which half of the LAD bus the port or memory is aligned. If the port is on LAD0–LAD15, the  $\overline{\text{SIZE16}}$  input should be low during the second cycle access (odd word); otherwise, if the port is on LAD16–LAD31, the  $\overline{\text{SIZE16}}$  input must be high at this time. The TMS34020 always performs two memory cycles to access the 16-bit wide memories, even when attempting only a 16-bit transfer.

The TMS34020 outputs the four  $\overline{\text{CAS}}$  strobes and LAD bus initially aligned for a 32-bit bus. If the memory is 16 bits wide, the two most significant  $\overline{\text{CAS}}$  strobes are swapped with the two least significant strobes when it accesses the second word, and the halves of the LAD bus are also swapped; therefore, 16-bit memories need to respond only to the two  $\overline{\text{CAS}}$  strobes corresponding to the upper or lower 16 bits of the LAD bus to which they are connected.

Note that devices connected to LAD0–LAD15 transfer the least significant word during the first cycle and the most significant word during the second cycle. Data accesses on LAD16–LAD31 transfer the most significant word first, then the least significant word.

The second memory cycle forced by the  $\overline{\text{SIZE16}}$  pin is performed as a page-mode access if  $\overline{\text{PGMD}}$  was low during the first access. A read-write cycle to 16-bit page-mode memory requires five bus cycles that occur as address, read0, read1, write0, write1. If a 16-bit transfer is interrupted due to a bus fault, the restart causes the entire access to be restarted.

For memory that supports page-mode accesses ( $\overline{\text{PGMD}}$  low),  $\overline{\text{SIZE16}}$  is sampled during each access to memory. If  $\overline{\text{SIZE16}}$  is high on the even-word access, then a 32-bit transfer occurs over LAD0–LAD31. If  $\overline{\text{SIZE16}}$  is low on the even-word access (16-bit wide memory), then it is sampled again on the odd-word access to determine to which half of the LAD bus the memory is connected (low for connection to LAD0–LAD15 or high for connection to LAD16–LAD31).



### special 1M VRAM cycles

The TMS34020 provides control for special-function VRAM cycles that are available in the 1M devices. These cycles are obtained by the appropriate timing control of the SF,  $\overline{\text{CAS}}$ ,  $\overline{\text{TR/QE}}$ , and  $\overline{\text{WE}}$  pins of the VRAMs at the falling edge of  $\overline{\text{RAS}}$ . The cycles include:

- Load write mask.
- Load color mask.
- Block write (no mask).
- Block write (current mask).
- Write using mask.
- Alternate write transfer.

In addition, other special modes can be implemented by using external logic.

### multiprocessor arbitration

The multiprocessor interface allows multiple processors to operate in a system sharing the same local memory. The use of the grant in ( $\overline{\text{GI}}$ ) and the priority request signals ( $\overline{\text{R0}}$  and  $\overline{\text{R1}}$ ) allows a flexible method of passing control from one processor to another. The control scheme allows local memory cycles to occur back-to-back, even when passing control from one TMS34020 to another. Synchronization of multiple TMS34020s in a system occurs at reset with the rising edge of  $\overline{\text{RESET}}$  meeting the setup and hold requirements to CLKIN, so all TMS34020s are certain to respond to the  $\overline{\text{RESET}}$  during the same quarter cycle.  $\overline{\text{RESET}}$  is not required to be synchronous to CLKIN, except to allow synchronization of multiple TMS34020s in a system.

The  $\overline{\text{GI}}$  priority for multiprocessing environments is determined by arbitration logic external to the TMS34020. If  $\overline{\text{GI}}$  goes inactive (high), the TMS34020 releases the bus on the next available cycle boundary. If the cycle in progress has not successfully completed, the TMS34020 restarts the cycle upon regaining control of the bus. Normally, if the TMS34020 asserts both  $\overline{\text{R0}}$  and  $\overline{\text{R1}}$  low, it should be given the control of the bus by the arbitrator.

### host interface

The TMS34020 host interface allows the local memory to be mapped into the host address space. The TMS34020 acts as a DRAM controller for the host. The address for the host access is latched within the TMS34020; however, the data for the access is transferred via external transceivers. The host selects the address of a 32-bit long word for an access using the 27 host-address lines, HA5–HA31. If the host desires byte addressability, it can select the active bytes for the access by using HBS0–HBS3. The TMS34020 always reads 32 bits from memory; however, on host writes, it uses the host byte selects to enable  $\overline{\text{CAS0}}$ – $\overline{\text{CAS3}}$  to memory. The address and byte selects are latched at the falling edge of  $\overline{\text{HCS}}$  within the TMS34020. The host indicates a read or write by asserting  $\overline{\text{HREAD}}$  or  $\overline{\text{HWRITE}}$  (as appropriate) either before or after  $\overline{\text{HCS}}$ .  $\overline{\text{HREAD}}$  and  $\overline{\text{HWRITE}}$  must never be asserted at the same time.

The TMS34020 responds to a host-read request by latching the requested data in the external latches and providing HRDY to the host, indicating that the read cycle is completing. The rising edge of HDST with HRDY high indicates data is latched in the external transceivers.

The host indicates that a write to a particular location is required by providing the address and asserting the  $\overline{\text{HWRITE}}$  signal. The host must maintain both  $\overline{\text{HCS}}$  and  $\overline{\text{HWRITE}}$  asserted until valid data is in the transceivers. (The rising edge of  $\overline{\text{HOE}}$  with HRDY high indicates that the data previously stored in the external transceivers has been written to memory.) Typically, the rising edge of  $\overline{\text{HWRITE}}$  is used to strobe the data into the latches and signal the TMS34020 that the write access can start. The TMS34020 uses its byte-write capability to write only to the selected bytes.

# TMS34020, TMS34020A GRAPHICS PROCESSORS

SPVS004D – MARCH 1990 – REVISED NOVEMBER 1993

The TMS34020 always accesses the required location as latched at the falling edge of  $\overline{HCS}$ ; however, in order to increase the data rate, a look-ahead mechanism is implemented. The HINC (host increment enable) and HPFW (host prefetch after write enable) bits in the host control register (HSTCTLH) must be appropriately set to make optimum use of this feature. These bits provide four modes of operation as indicated in the following table:

HINC	HPFW	HOST ACCESS MODE	DESCRIPTION
0	0	RANDOM/SAME	No increment, no prefetch
0	1	RANDOM/SAME	No increment, no prefetch
1	0	BLOCK	Increment after read or write, prefetch after read
1	1	READ/MODIFY/WRITE	Increment after write, prefetch after write

When the TMS34020 is programmed for block-mode or read/modify/write accesses, the host can still do random accesses because the TMS34020 always uses the address provided at the falling edge of  $\overline{HCS}$ ; however, there is a prefetch to the next sequential address. The prefetch occurs after reads in block mode and after writes in read/modify/write mode. The TMS34020 compares the address latched by  $\overline{HCS}$  on host reads to see if it is the same as that of the last prefetched data. If the addresses match, data is not reaccessed, but HRDY is set high to indicate that the data is presently available.

## dynamic bus sizing on host accesses

If the host makes a read access to a 16-bit-wide memory, the TMS34020 automatically does the second cycle required to read the rest of the 32-bit word (even if the host did not require a 32-bit cycle). The external logic must comprehend the sense of  $\overline{SIZE16}$  or the  $\overline{CAS}$  strobes during the accesses in order to route the data into the proper external host data transceivers. The TMS34020 uses the host byte selects (HBS0–HBS3) to enable the  $\overline{CAS}$  strobes when doing a host write.

## coprocessor interface

Support for coprocessors is provided through special instructions and bus cycles that allow communication with the coprocessor. A coprocessor may be register-based, depending on the TMS34020 to do all address calculations, or it may operate as its own bus controller, using the multiprocessor arbitration scheme. Five basic cycles are provided for direct communication and control of coprocessors.

1. TMS34020 to coprocessor.
2. Coprocessor to TMS34020.
3. Move memory to coprocessor.
4. Move coprocessor to memory.
5. Coprocessor internal command.

The first four of these cycles provide for command of the coprocessor in addition to the movement of parameters to and from the coprocessor. In this manner, parameters can be sent to the coprocessor and operated upon without an explicit coprocessor command cycle.

## instruction set

The TMS34020 instruction set can be divided into five categories:

1. Graphics instructions.
2. Coprocessor instructions.
3. Move instructions.
4. General-purpose instructions.
5. Program control and context switching.

Specialized *graphics instructions* manipulate pixel data that is accessed via memory addresses or XY coordinates. These instructions include graphics operations, such as array and raster ops, pixel processing, windowing, plane masking, pixel masking, and transparency. *Coprocessor instructions* allow for the control and data flow to and from coprocessors that reside in the system. *Move instructions* comprehend the bit-addressing and field operations, which manipulate fields of data using linear addressing for transfer to and from memory and the register file. *General purpose instructions* provide a complete set of arithmetic and Boolean operations on the register file, as well as general program control and data processing. *Program control and context switching instructions* allow the user to control flow and to save and restore information using instructions with both register-direct and absolute operands.

## clock stretch

The TMS34020A supports a clock stretching mechanism, which is described in outline below.

With advances in semiconductor manufacturing, new versions of the TMS34020A can be made, each supporting a higher CLKIN frequency. The increase in CLKIN frequency means that the TMS34020A machine cycles execute more quickly, with a consequent increase in code execution speed. However, there comes a point when, as the machine cycle time becomes shorter, the local memory control signals begin to violate DRAM and VRAM timing parameters for certain types of memory access.

The clock-stretch mechanism allows the TMS34020A to slow down and execute those critical local memory cycles, while still benefiting from the accelerated processing allowed by higher CLKIN frequencies during noncritical memory access cycles.

Exact timing issues will vary from system to system, reflecting differences in bus buffering, etc., but broadly speaking the clock-stretch mechanism allows the system designer to interface to slower (and hence cheaper and more available) memory devices than the designer could use if no stretch mechanism were available.

A normal, unstretched machine cycle consists of four quarter cycles, Q1, Q2, Q3, and Q4. A stretched cycle consists of five quarter cycles Q1, Q2, Q3, and Q4a, and Q4b.

When clock-stretch mode is enabled, the fourth machine quarter cycle may be stretched to twice its original length. This stretching takes place only when the TMS34020A attempts certain types of memory cycle.

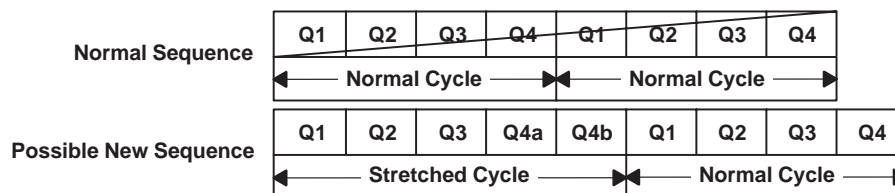

The stretch is achieved by holding the internal TMS34020A clocks in the Q4 state for an extra quarter cycle so all the device outputs remain unchanged during Q4a and Q4b. The TMS34020A stretches only certain machine cycles so that the execution of code is not slowed unnecessarily.

# TMS34020, TMS34020A GRAPHICS PROCESSORS

SPVS004D – MARCH 1990 – REVISED NOVEMBER 1993

## enabling clock stretch

Clock-stretch mode is enabled and disabled via a bit in the CONFIG register (C00001A0h).

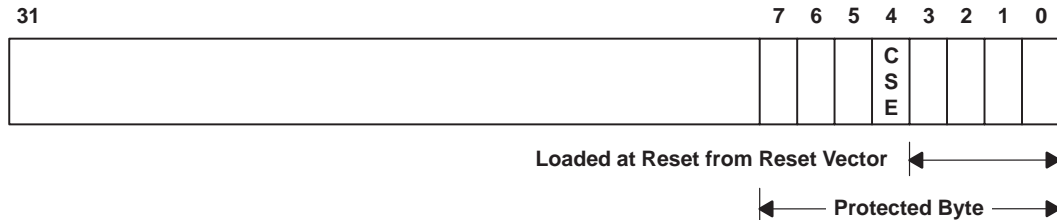

### CONFIG register C00001A0h

CSE = 0: Disable stretch mode (normal operation)

CSE = 1: Enable stretch mode

Bit 4 of the CONFIG register is the clock-stretch-enable mode bit. A 0 in this bit will disable stretch mode and a 1 in this bit will enable stretch mode. The bit is cleared during reset; i.e., stretch mode is disabled by default.

When stretch mode is enabled, the following machine cycles are stretched:

1. All address cycles of all memory access sequences.
2. Read data cycles in read-modify-write sequences.

#### Notes:

- a) The host default cycle shown on page 8-49 of the *TMS34020 User's Guide* is not stretched because it is not a true address cycle; i.e.,  $\overline{RAS}$ , etc., do not go low.
- b) The CPU default cycle, which is similar to the host default cycle in that  $\overline{RAS}$ , etc., do not go low, is also not stretched.
- c) Clock-stretch mode disregards the page-mode input, so that read data cycles in nonpage-mode read-modify-write sequences are stretched, even though there are no timing constraints that require a stretch.
- d) All other memory subcycles are *not* stretched, even if the TMS34020A is running with the CSE bit set to 1.

The advantage of this implementation of clock-stretch mode is that the TMS34020A can execute code at maximum speed, slowing down only during certain parts of memory access sequences.

It is important to remember that a stretched cycle is 25% longer than a normal cycle, and that the TMS34020A (with the exception of the video logic, which is clocked independently by VCLK) will effectively slow down during such a stretched cycle.

The following are examples of stretch-mode memory operations.

**two 32-bit nonpage-mode reads**



**one 32-bit page-mode read-modify-write**

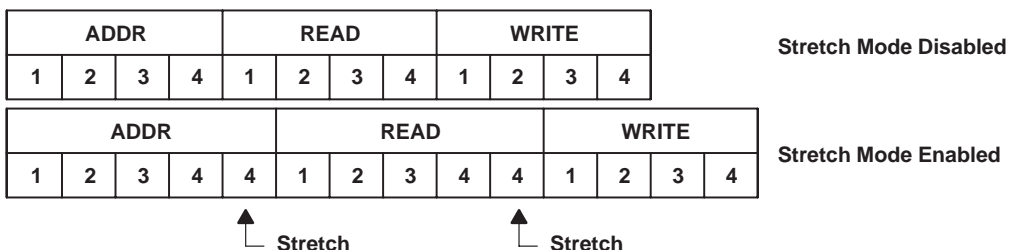

**three 32-bit page-mode reads**

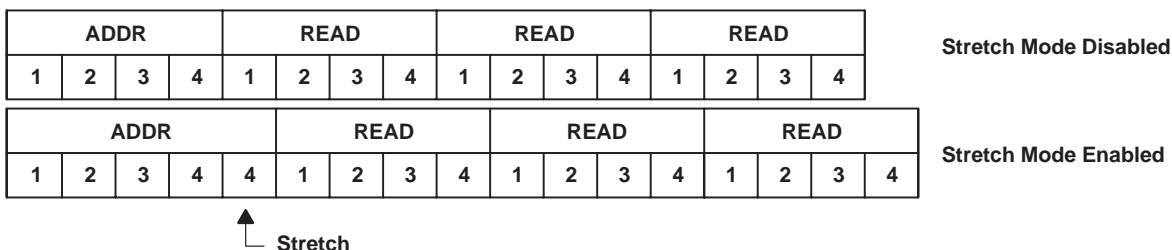

The stretched cycles are designed to accommodate worst-case 32-bit page-mode accesses, so during some nonpage-mode memory accesses, stretches that are not essential may be generated. For example:

**one 32-bit nonpage-mode read-write**

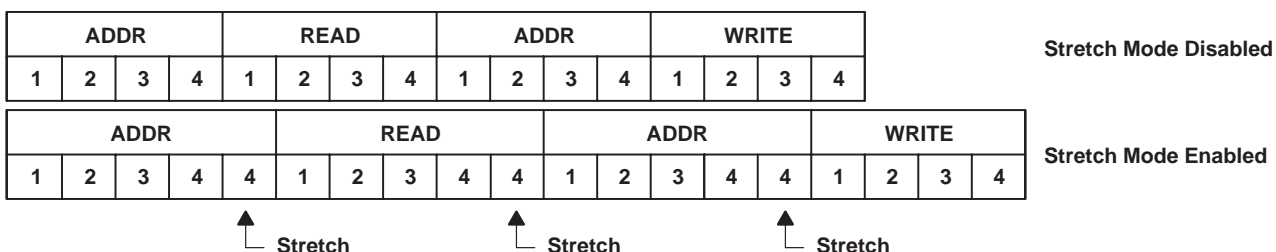

Stretches are inserted in read-modify-write accesses to help ease bus turn-around timings. In the above example, the second stretch is not needed to help these timings because the read/write turn-around has the whole of the address cycle to evaluate.

# TMS34020, TMS34020A GRAPHICS PROCESSORS

SPVS004D – MARCH 1990 – REVISED NOVEMBER 1993

## a clock-stretch timing example, TMS34020A-40 and 100-ns VRAMs

This example analyzes a memory interface timing parameter. It shows that the clock stretch mechanism can be used to allow the TMS34020A-40 to avoid a timing violation when interfaced to 100-ns VRAMs.

Consider a system with:

1. TMS34020A-40, which has a 40-MHz clock input frequency and hence a 100-ns cycle time, so  $t_Q = 25$  ns. Timing parameters are taken from the TMS34020 data sheet.
2. TMS44C251-10 256K  $\times$  4 bit VRAM. Timing parameters are taken from the appropriate section in the Texas Instruments *MOS Memory Data Book*, 1989.

### row address hold data after $\overline{RAS}$ low, $t_{h(ADV-REL)}$

*Without clock stretch*

TMS44C251	$t_{h(RA)}$	Row address hold time after $\overline{RAS}$ low.	Min = 15 ns
TMS34020A	Parameter 88	Hold time, row address valid after $\overline{RAS}$ low.	Min = $t_Q - 5$ ns = 20 ns.

If  $\overline{RAS}$  is passed through a PAL™ with a delay of 7 ns then  $t_{h(RA)}$  seen by the VRAM is 20 ns – 7 ns = 13 ns. This violates the 15 ns minimum.

*With clock stretch*

TMS34020A	Parameter 88	Hold time, row address valid after $\overline{RAS}$ low.	Min = $2t_Q - 5$ ns = 45 ns.
-----------	--------------	----------------------------------------------------------	------------------------------

With the same 7-ns PAL delay, the VRAM sees  $t_{h(RA)}$  as 45 ns – 7 ns = 38 ns, which does not violate the VRAM minimum of 15 ns.

## cycle timing examples

The following figures show examples of many of the basic cycles that the TMS34020 uses for memory access, VRAM control, multiprocessor bus control, and coprocessor communication. These figures should not be used to determine specific signal timings, but can be used to see signal relationships for the various cycles. Q4 phases that *could* be stretched are marked with a \* on the diagrams. The conditions required for the stretch are:

1. The design uses a TMS34020A
2. The CONFIG register's CSE bit is set to 1
3. The TMS34020A is doing either:
  - a) Any address cycle, or
  - b) A read data cycle in a read-modify-write sequence.

The following remarks apply to memory timing in general. A row address is output on RCA0–RCA12 at the start of a cycle, along with the full address and status on LAD0–LAD31. These remain valid until after the fall of  $\overline{ALTCH}$  and  $\overline{RAS}$ . The column address is then output on RCA0–RCA12, and LAD0–LAD31 are set to read or write data for the memory access. During a write, the data and  $\overline{WE}$  are set valid prior to the falling edge of  $\overline{CAS}$ ; the data remains valid until after  $\overline{WE}$  and  $\overline{CAS}$  have returned high.

Large memory configurations may require external buffering of the address and data lines. The DDIN and DDOUT signals coordinate these external buffers with the LAD bus.

PAL is a trademark of Advanced Micro Devices, Inc.





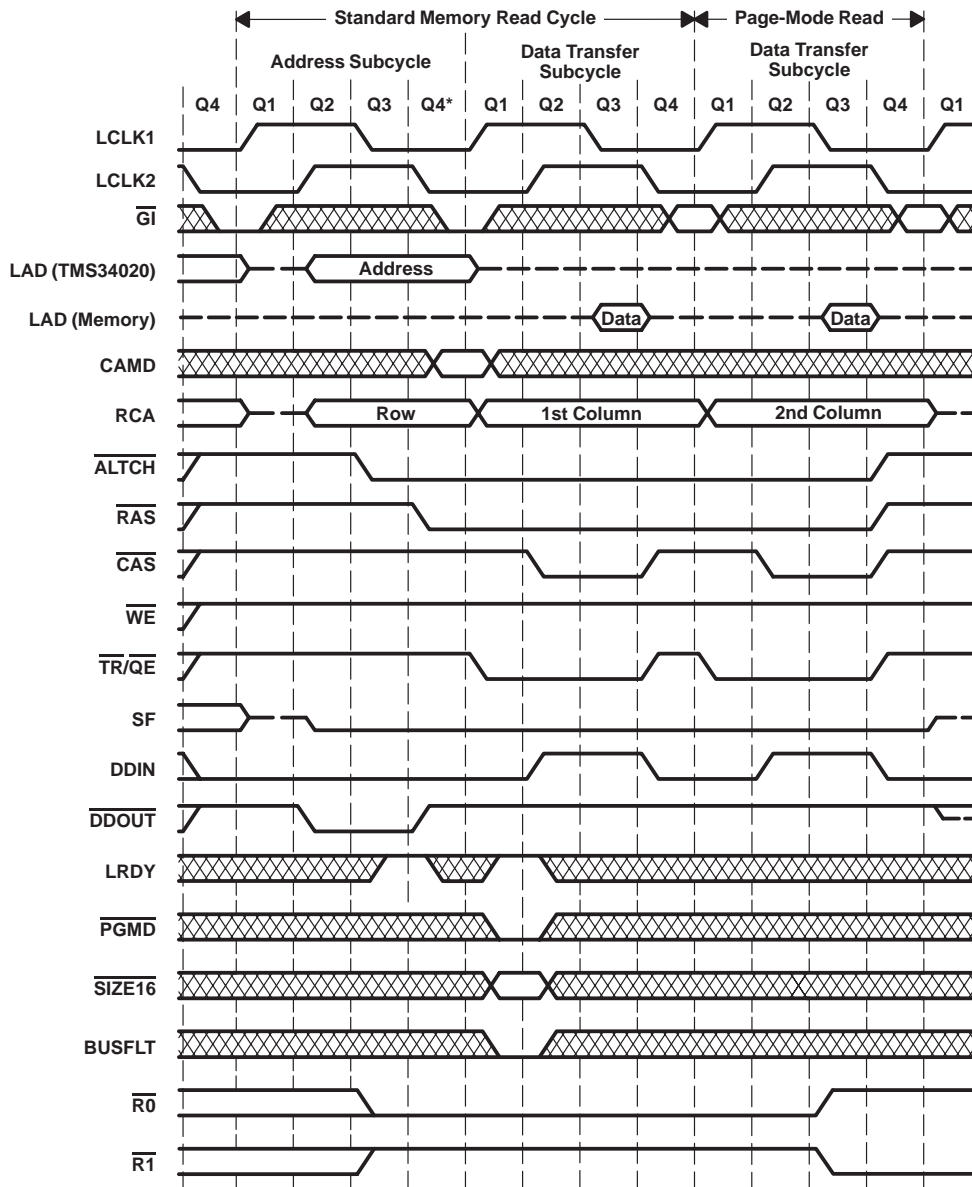

\*See clock stretch, page 21.

NOTES: A. LAD (TMS34020): Output to the LAD bus by the TMS34020.

LAD (memory): Output to the LAD bus by the memory.

B. LRDY, PGMD, SIZE16, and BUSFLT are not sampled on subsequent page-mode cycle accesses to 32-bit-wide memory space.

**Figure 2. Local Memory Read Cycle Timing (With Page Mode)**

During the address output to the LAD bus by the TMS34020, the least significant four bits (LAD0–LAD2) contain a bus status code. PGMD low at the start of Q2 after RAS low indicates that this memory supports page-mode operation. LRDY high at the start of Q2 after RAS low indicates that the cycle can continue without inserting wait states. DDOUT returns high after the initial address output on LAD (during Q4), indicating that a memory read cycle is about to take place.

# TMS34020, TMS34020A GRAPHICS PROCESSORS

SPVS004D – MARCH 1990 – REVISED NOVEMBER 1993

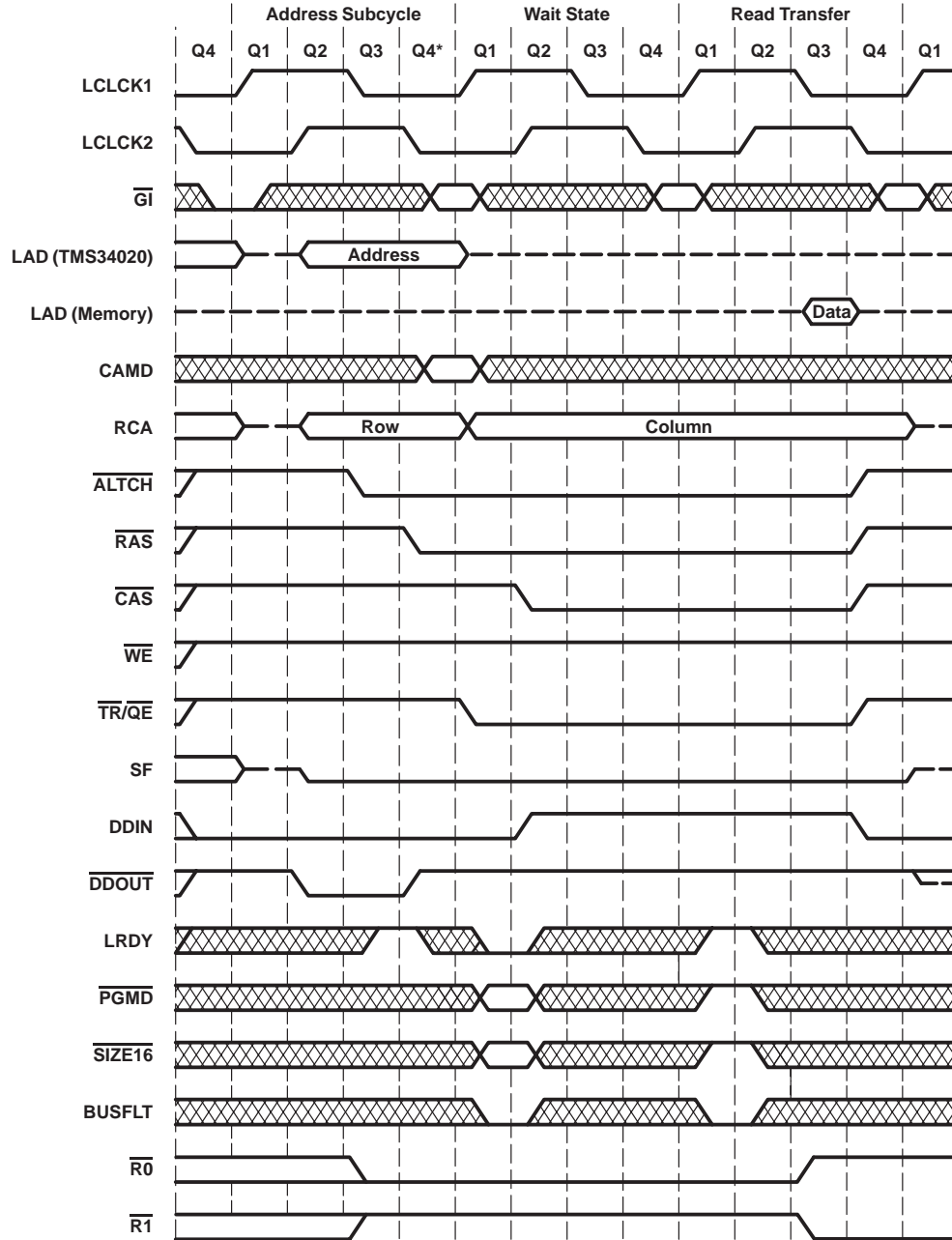

\*See clock stretch, page 21.

NOTES: A. LAD (TMS34020): Output to the LAD bus by the TMS34020. LAD (memory): Output to the LAD bus by the memory.

B. Although they are not internally sampled, PGMD and SIZE16 must be held at a valid level at the start of each Q2 until the LRDY is sampled high.

**Figure 3. Local Memory Read Cycle Timing (Without Page Mode, With One Wait State)**

LRDY low at the start of the first Q2 after  $\overline{RAS}$  low indicates that the memory requires the addition of wait states. LRDY high at the next Q2 indicates the cycle can continue without inserting more wait states. PGMD high at the start of Q2 where LRDY is sampled high indicates that this memory does not support page-mode operation.

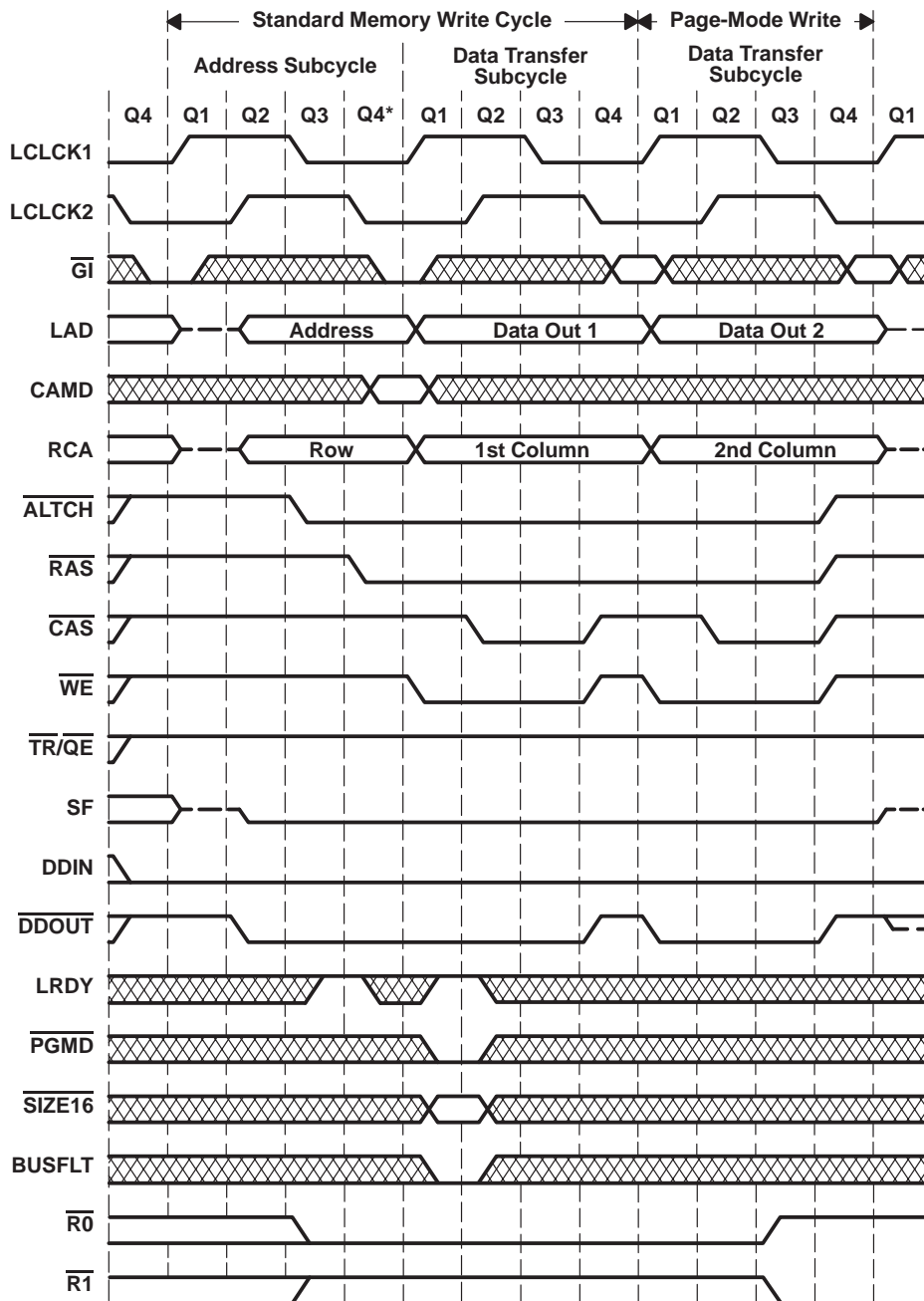

\*See clock stretch, page 21.

NOTE A: LRDY, PGMD, SIZE16, and BUSFLT are not sampled on subsequent page-mode cycle accesses to 32-bit-wide memory space.

**Figure 4. Local Memory Write Cycle Timing (With Page Mode)**

During the address output to the LAD bus by the TMS34020, the least significant four bits (LAD0–LAD3) contain a bus-status code. PGMD low at the start of Q2 after RAS low indicates that this memory supports page-mode operation. LRDY high at the start of Q2 after RAS low indicates that the cycle can continue without inserting wait states.

DDOUT remains low after the initial address output on LAD (during Q4 after RAS goes low), indicating that a memory write cycle is about to take place.

# TMS34020, TMS34020A GRAPHICS PROCESSORS

SPVS004D – MARCH 1990 – REVISED NOVEMBER 1993

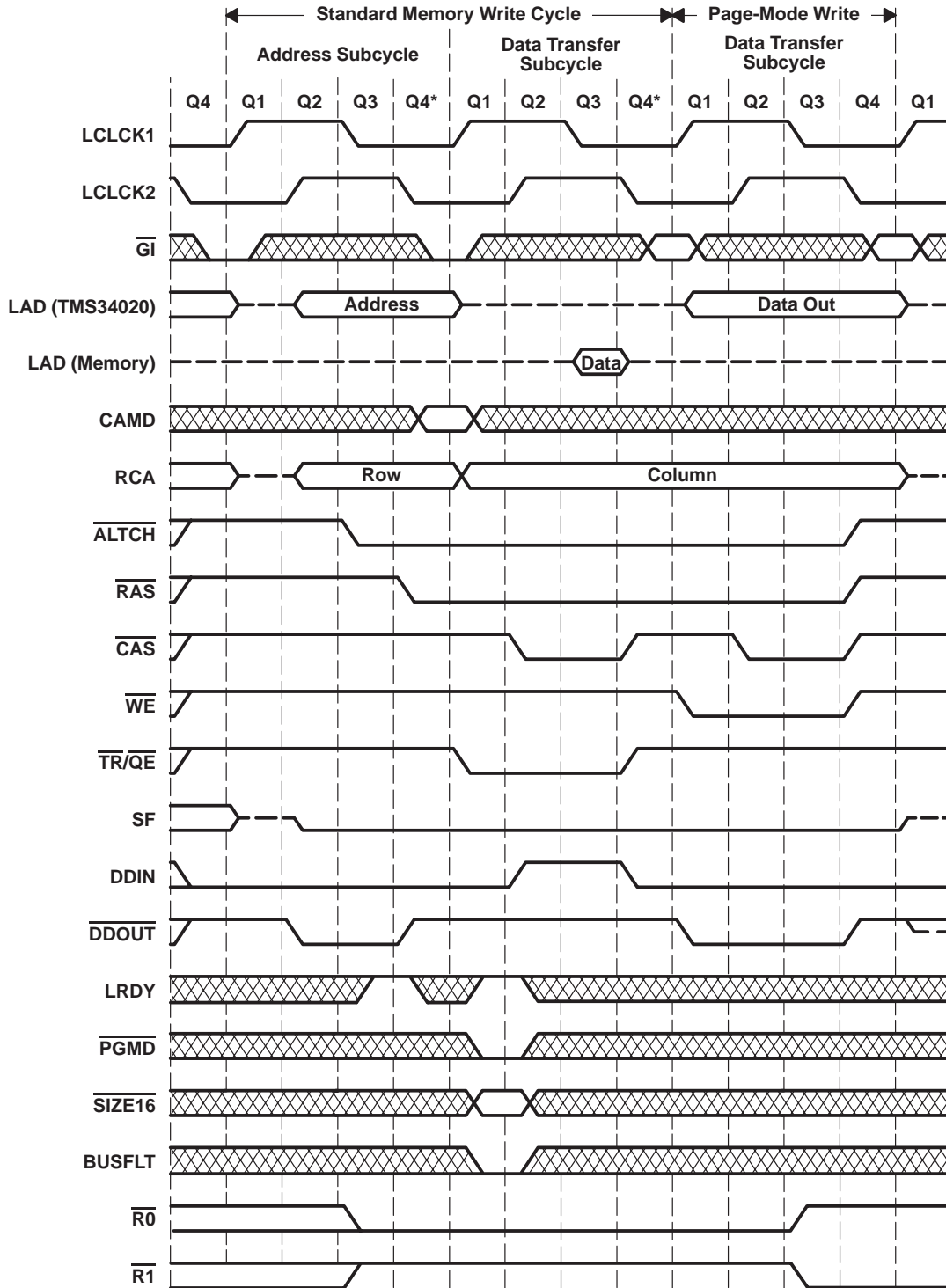

\*See clock stretch, page 21.

**Figure 5. Local Memory Read/Modify/Write Cycle Timing**

The read/modify/write cycle is used when inserting a field into memory that crosses byte boundaries. This cycle is actually performed as a read access followed by a page-mode write cycle.

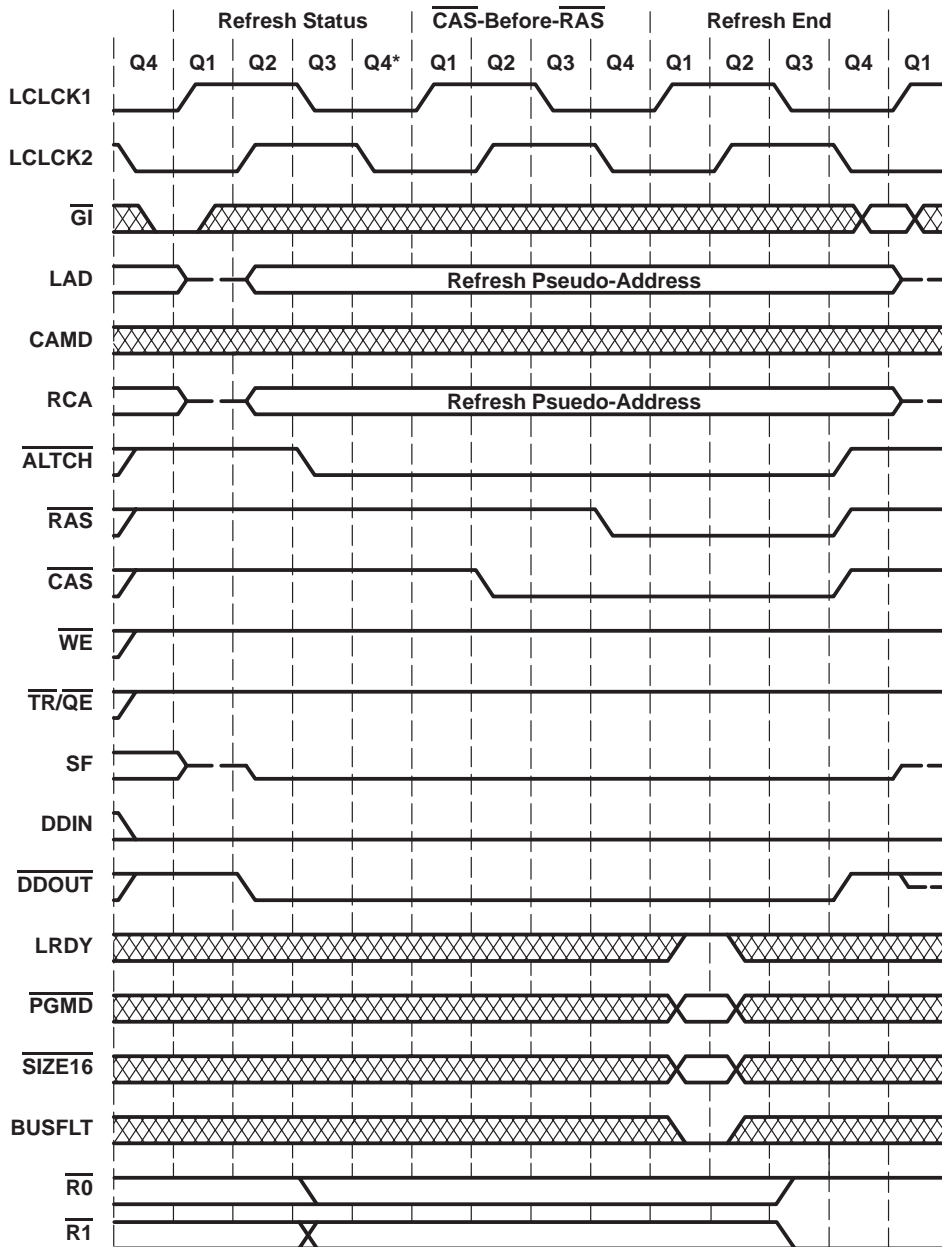

\*See clock stretch, page 21.

Figure 6. Refresh Cycle Timing

The refresh pseudo-address output to RCA0–RCA12 and LAD0–LAD31 comes from the 16-bit refresh address register (I/O register C000 01F0h) that is incremented after each refresh cycle. The 16 bits of address are placed on LAD16–LAD31; all other LAD bus lines will be zero. The logical addresses on RCA0–RCA12 corresponding to LAD16–LAD31 also output the address from the refresh-address register.

Although  $\overline{PGMD}$  and  $\overline{SIZE16}$  are ignored during a refresh cycle, they should be held at valid levels. LRDY and BUSFLT are not sampled until the start of the first Q2 cycle after  $\overline{RAS}$  has gone low.

If a refresh cycle is aborted due to a high-priority bus request (assuming LRDY is low at Q2 after  $\overline{RAS}$  low), a bus fault, or an external retry, then the count of refreshes pending is not decremented and the same pseudo-address is reissued when the refresh is restarted.

# TMS34020, TMS34020A GRAPHICS PROCESSORS

SPVS004D – MARCH 1990 – REVISED NOVEMBER 1993

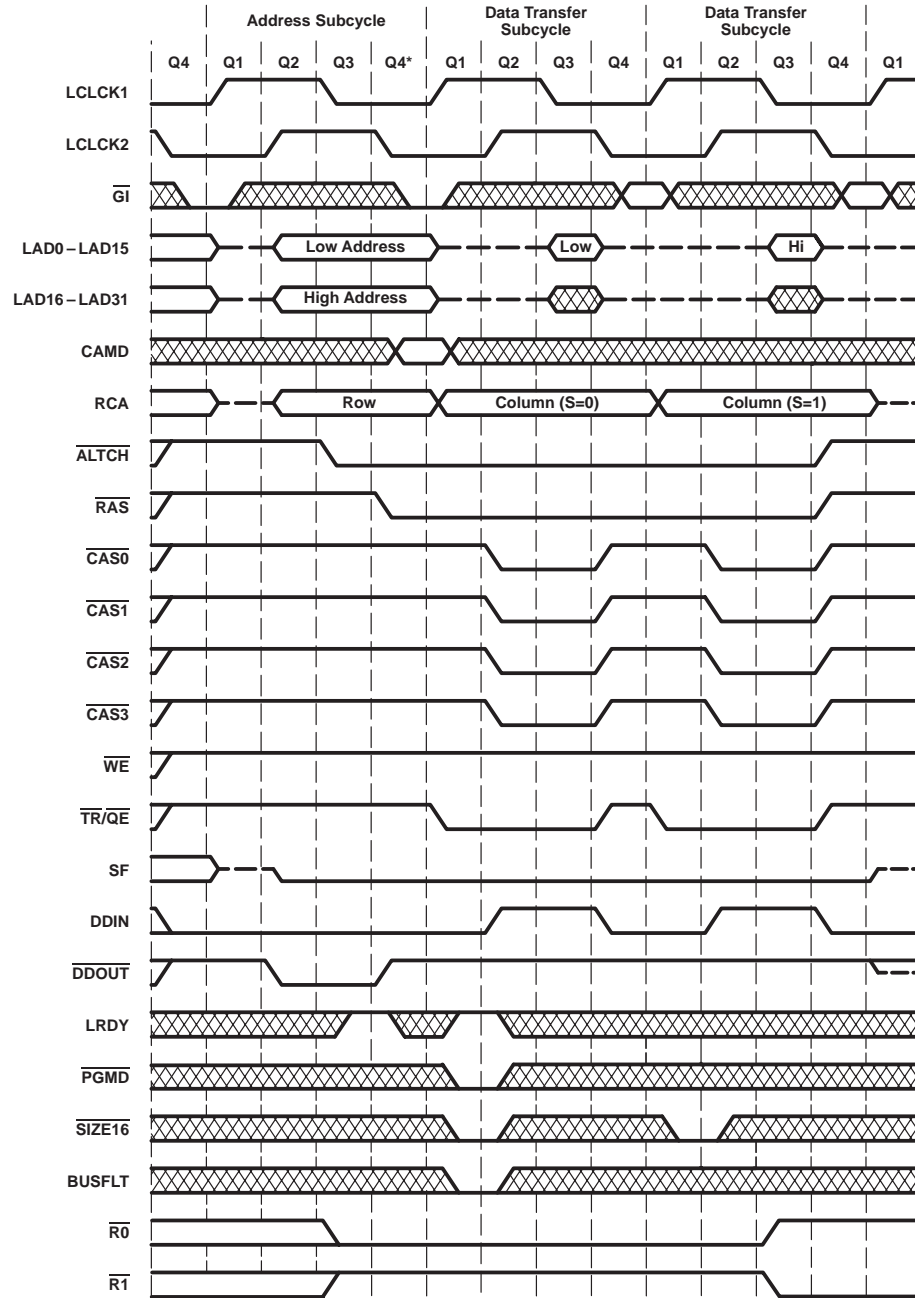

\*See clock stretch, page 21.

NOTE A: RCA0 may be used to determine accesses to odd or even words because it outputs the least significant bit of the word address during the column-address time (except in 4M-mode with CAMD = 1).

**Figure 7. Dynamic Bus Sizing, Read Cycle**

When  $\overline{\text{SIZE16}}$  is selected low, the TMS34020 performs a second cycle to read (or write) the remaining 16 bits of the word. Reads always access all 32 bits (all  $\overline{\text{CAS}}$  strobes are active). Internally, the TMS34020 latches both the high and the low words obtained on the first read cycle. The sense of  $\overline{\text{SIZE16}}$  on the second (odd-word) access is used to determine which half of the bus is to be sampled to replace the data word latched during the first cycle.

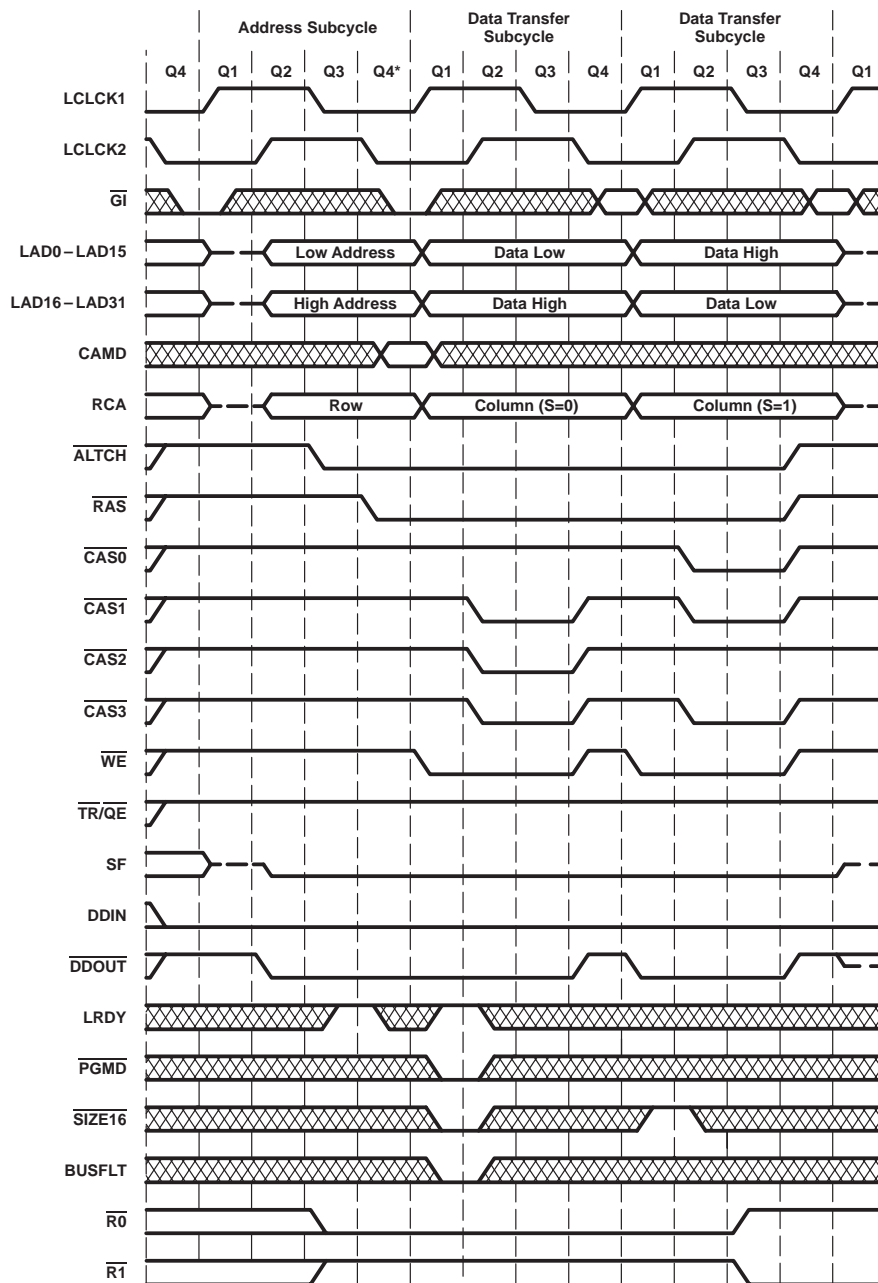

\*See clock stretch, page 21.

**Figure 8. Dynamic Bus Sizing, Write Cycle**

Write accesses to 16-bit memory are performed by swapping the data on upper and lower words of the LAD bus and exchanging data on  $\overline{\text{CAS0}}$  and  $\overline{\text{CAS1}}$  for data on  $\overline{\text{CAS2}}$  and  $\overline{\text{CAS3}}$ , respectively. This is illustrated in the above example where the TMS34020 is writing the upper 24 bits (LAD8–LAD31) of data to memory. During the first cycle, data is placed on LAD0–LAD31 as in a normal write. The sampling of  $\overline{\text{SIZE16}}$  low during the first access indicates that this is 16-bit-wide memory, so the TMS34020 swaps data on the upper and lower halves of the LAD bus. Notice that during the first cycle  $\overline{\text{CAS0}}$  is inactive (since this byte was not selected) and during the second cycle  $\overline{\text{CAS2}}$  is inactive due to the exchange of  $\overline{\text{CAS0}}$  for  $\overline{\text{CAS2}}$  and  $\overline{\text{CAS1}}$  for  $\overline{\text{CAS3}}$ .

# TMS34020, TMS34020A GRAPHICS PROCESSORS

SPVS004D – MARCH 1990 – REVISED NOVEMBER 1993

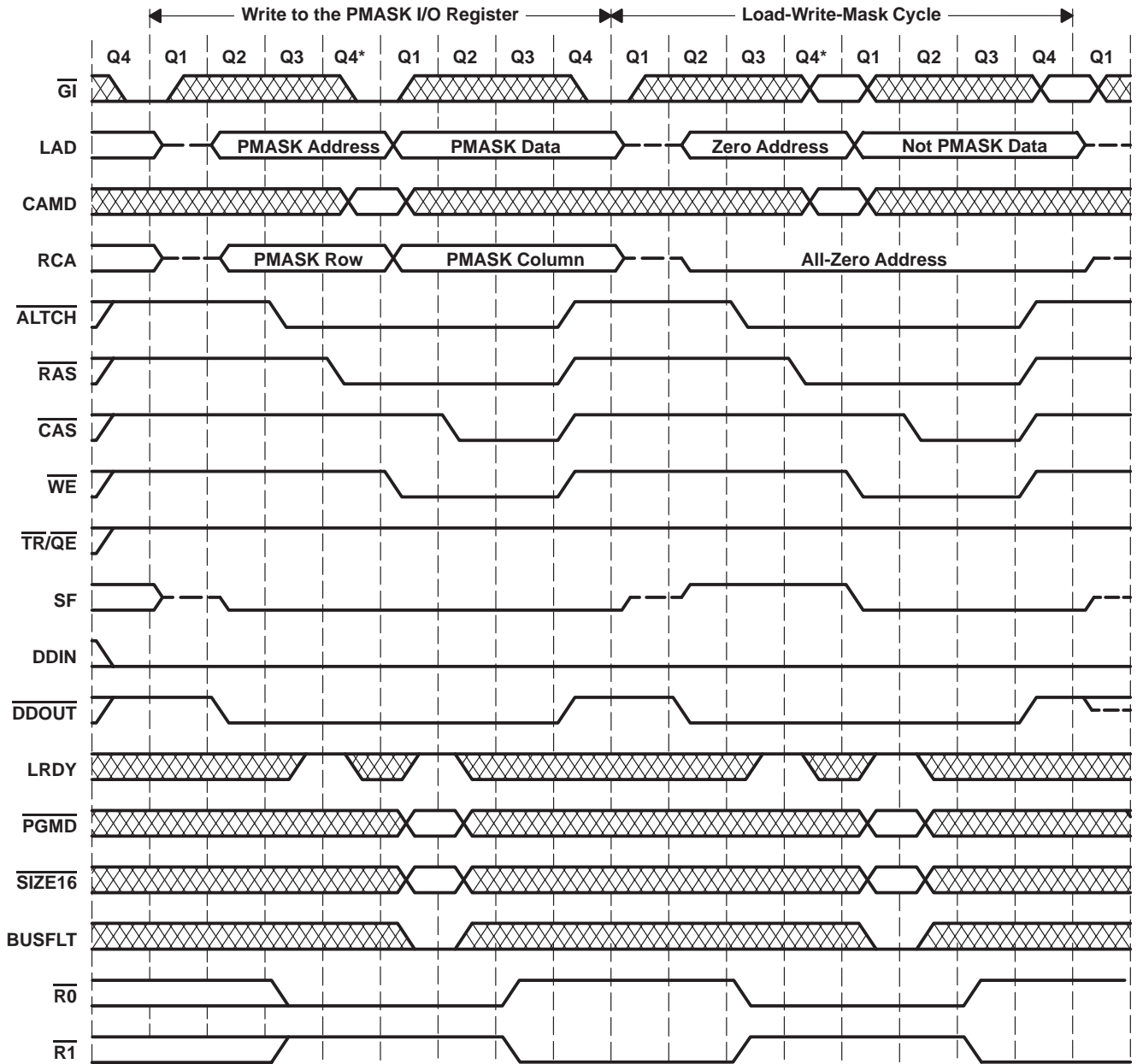

\*See clock stretch, page 21.

**Figure 9. Load Write Mask Cycle**

This special 1M VRAM control cycle is executed when the VEN bit in the CONFIG I/O register is set and PMASKL and/or PMASKH are written. This cycle is indicated by  $\overline{\text{CAS}}$ ,  $\overline{\text{WE}}$ ,  $\overline{\text{TR/QE}}$ , and SF high at the falling edge of  $\overline{\text{RAS}}$  and SF low at the falling edge of  $\overline{\text{CAS}}$ . As the plane mask is copied to the PMASK register(s), it is also output on the LAD bus to be written to a special register on the VRAM that is used in subsequent cycles requiring a write mask. During the address portion of the cycle, the status on LAD0–LAD3 indicates a write-mask load is being performed (status code = 0110). Although CAMD, PGMD, and SIZE16 are ignored on this cycle, they should be held at valid levels as shown.



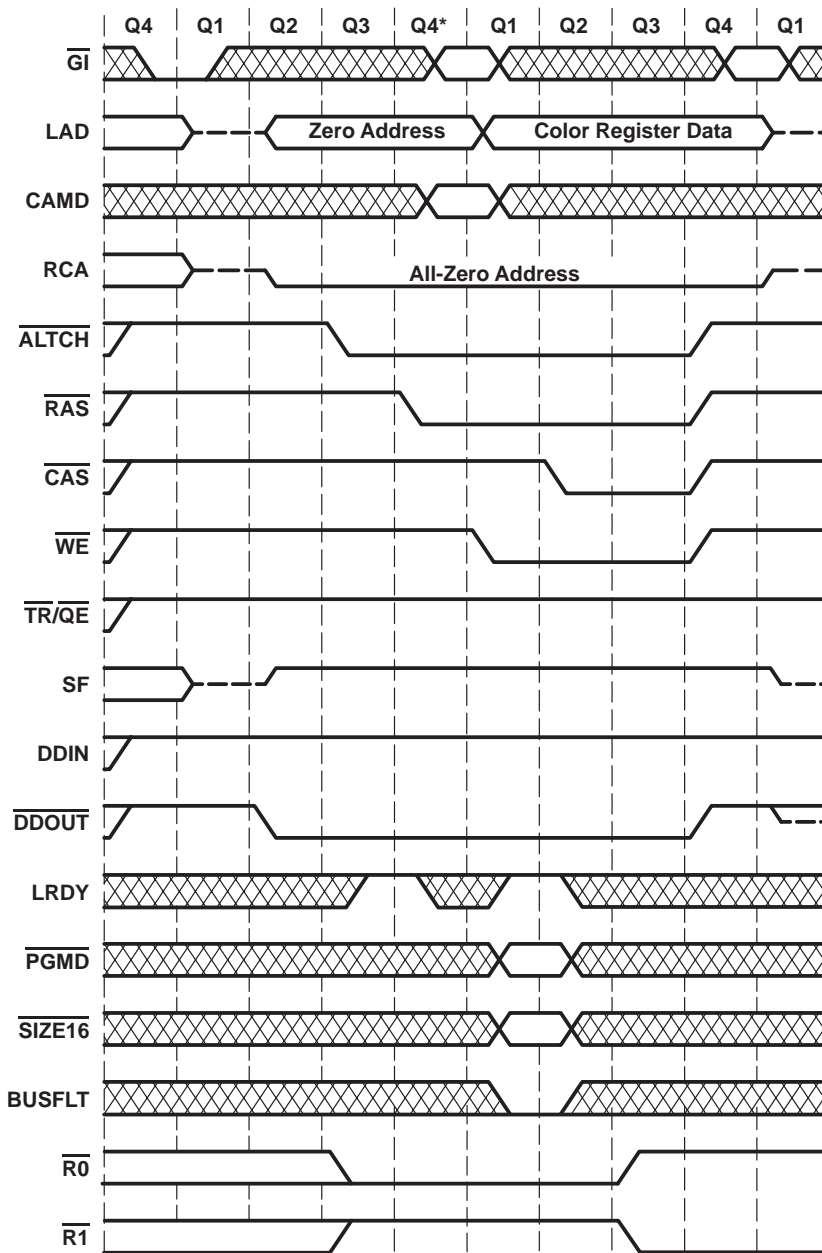

\*See clock stretch, page 21.

**Figure 10. Load-Color-Latch Cycle**

This special 1M VRAM control cycle is generated by the VLCOL instruction and is indicated by  $\overline{\text{CAS}}$ ,  $\overline{\text{WE}}$ ,  $\overline{\text{TR/QE}}$ , and SF high at the falling edge of RAS and SF high at the falling edge of CAS. The data in the COLOR1 register is output on LAD to be written to a special register on the VRAM that is used in subsequent cycles requiring a color latch. During the address portion of the cycle, the status on LAD0–LAD3 indicates a color-mask load is being performed (status code = 0111). Although CAMD, PGMD, and SIZE16 are ignored on this cycle, they should be held at valid levels as shown.

# TMS34020, TMS34020A GRAPHICS PROCESSORS

SPVS004D – MARCH 1990 – REVISED NOVEMBER 1993

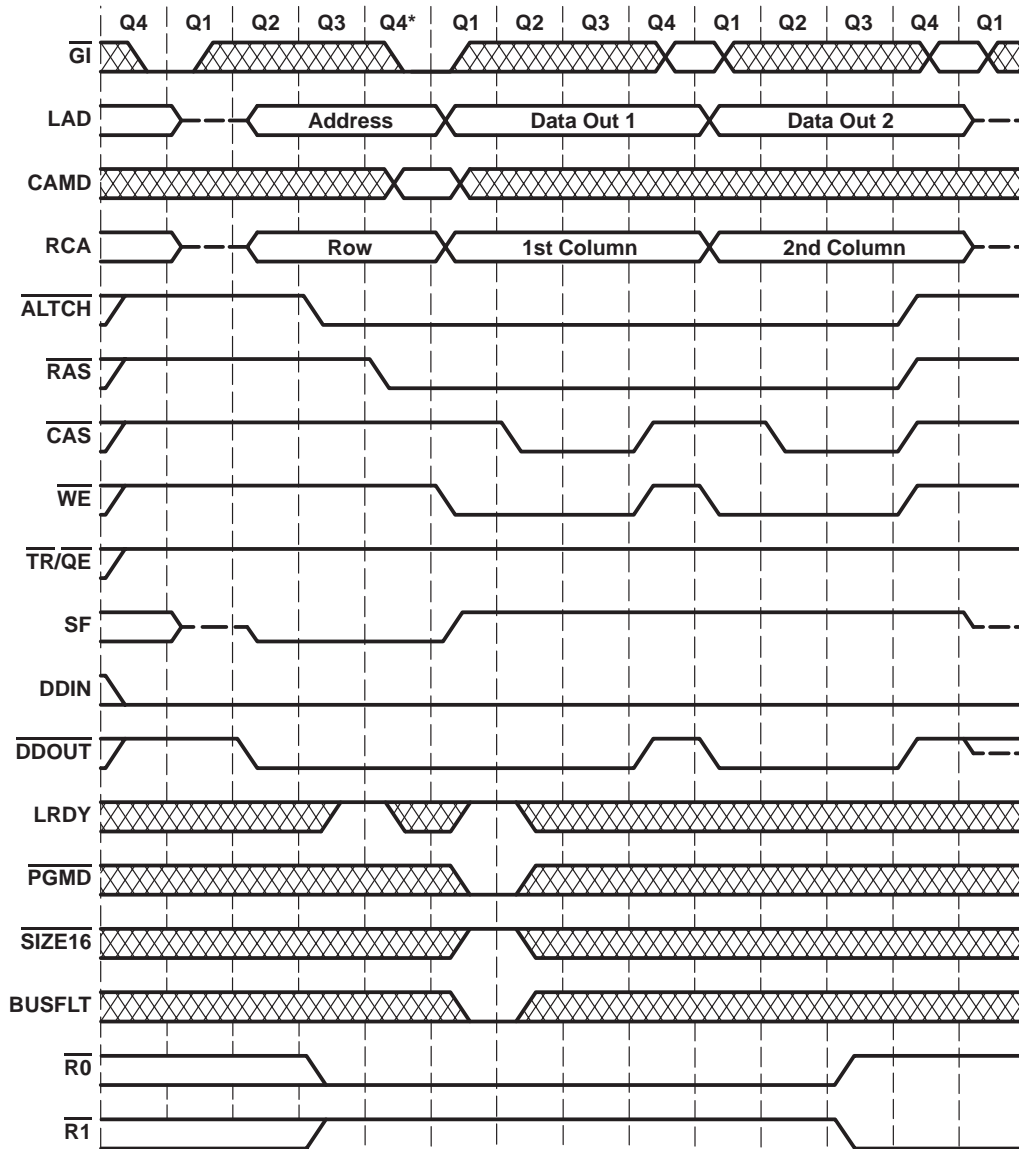

\*See clock stretch, page 21.

**Figure 11. Block-Write Cycle Without Mask**

This special 1M VRAM control cycle is performed when a VBLT or VFILL instruction is executed and PMASKL and PMASKH are set to zero. It is indicated by  $\overline{\text{CAS}}$ ,  $\overline{\text{WE}}$ ,  $\overline{\text{TR/QE}}$  high and SF low at the falling edge of  $\overline{\text{RAS}}$ , and by SF high at the falling edge of  $\overline{\text{CAS}}$ . The data on LAD is used as an address mask, and the data stored in the color latch is written to the VRAM. The address selects chosen by the two least significant bits of the column addresses within the VRAM are replaced with the four DQ bits latched on the falling edge of  $\overline{\text{CAS}}$ . A logic 1 on each bit enables that nibble to be written, while a logic 0 disables the write from occurring. This cycle allows up to 16 bits to be written into each VRAM (four adjacent nibbles, each set to the value in the color latch) for a total of 128 bits. During the address portion of the cycle, the status on LAD0–LAD3 indicates a block write is being performed (status code = 1110). SIZE16 can be used with this cycle, but external multiplex logic is required to map the data correctly to appropriate memories.

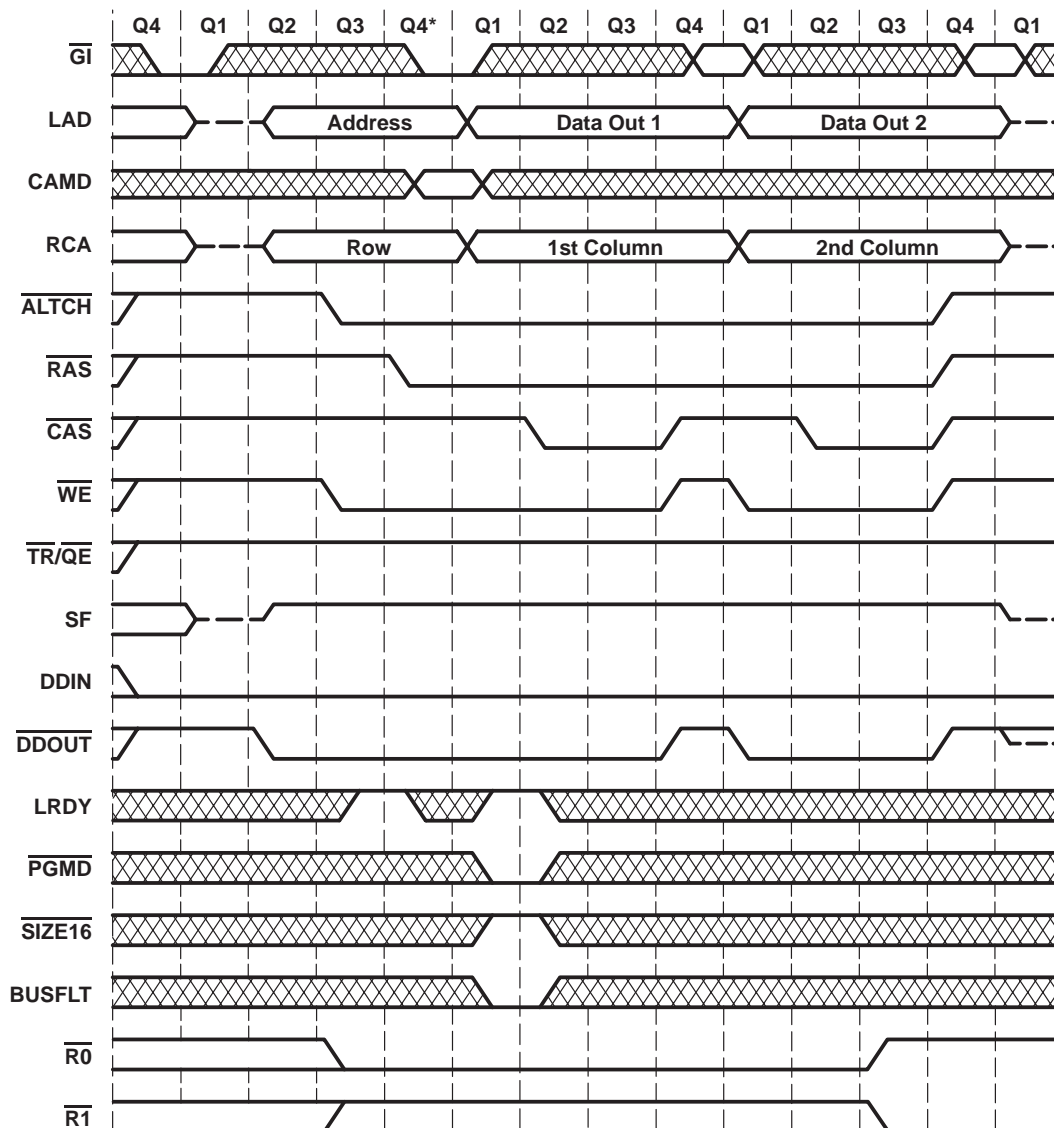

\*See clock stretch, page 21.

**Figure 12. Block-Write Cycle With Mask**

This special 1M VRAM control cycle is performed when a VBLT or VFILL instruction is executed and PMASKL and PMASKH are set to nonzero. It is indicated by  $\overline{\text{CAS}}$ ,  $\overline{\text{TR/QE}}$ , and SF high and  $\overline{\text{WE}}$  low at the falling edge of  $\overline{\text{RAS}}$ , and by SF high at the falling edge of  $\overline{\text{CAS}}$ . The data on LAD is used as an address mask, and the data stored in the color latch is written to the VRAM, just as in the block-write cycle without mask, except that the data in the write mask is used to enable the bits from the color latch that are written to memory. This cycle allows up to 16 bits to be written into each VRAM (four adjacent nibbles, each set to the value in the color latch as enabled by the write mask) for a total of 128 bits. During the address portion of the cycle, the status on LAD0–LAD3 indicates a block write is being performed (status code = 1110). SIZE16 can be used with this cycle, but external multiplex logic is required to map the data correctly to appropriate memories.

# TMS34020, TMS34020A GRAPHICS PROCESSORS

SPVS004D – MARCH 1990 – REVISED NOVEMBER 1993

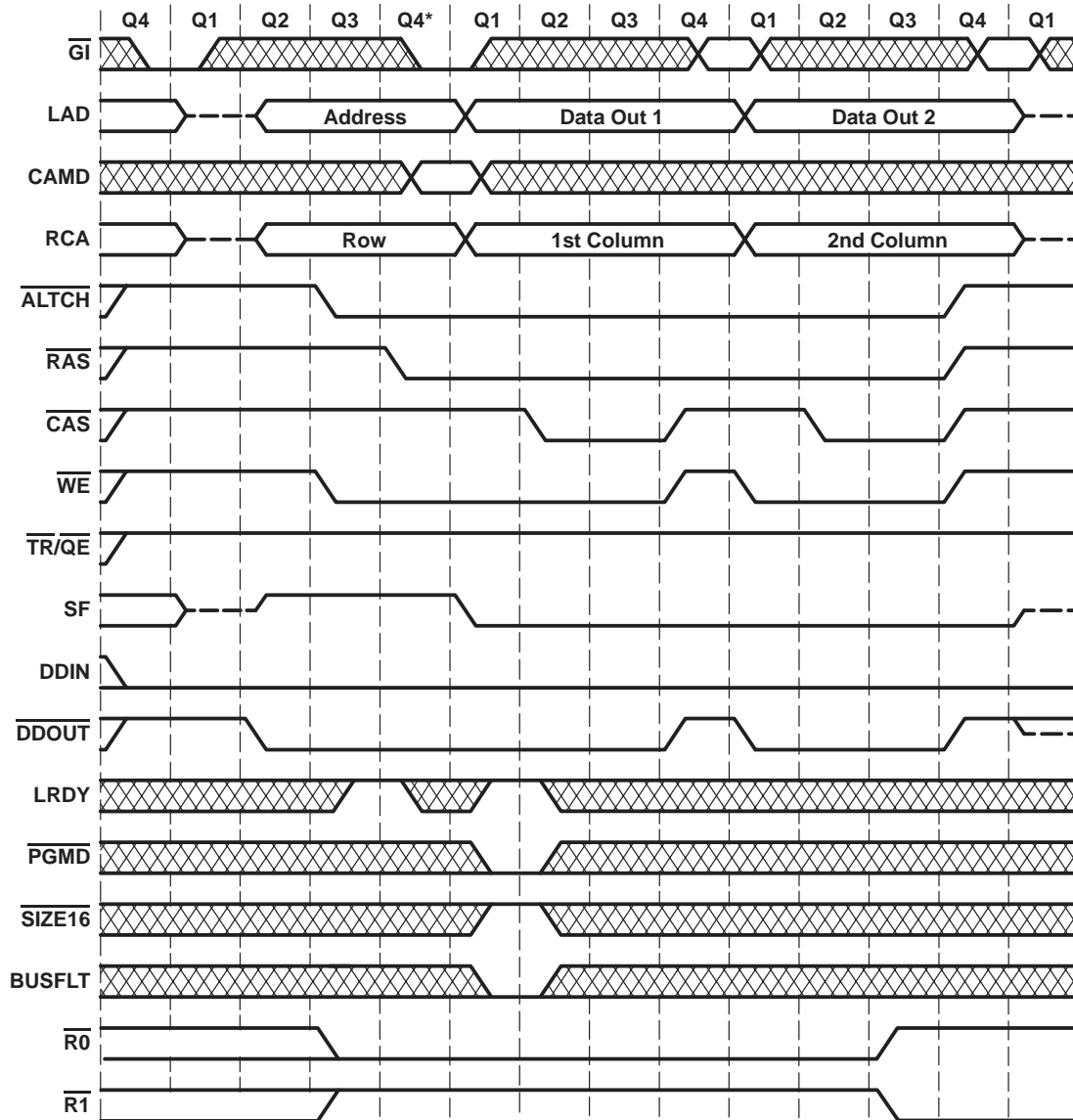

\*See clock stretch, page 21.

**Figure 13. Write Cycle Using Mask**

This special 1M VRAM control cycle is performed when the PMASKL and PMASKH registers are set to nonzero, the CST bit in DPYCTL is cleared, the VEN bit in CONFIG is set, and the byte-aligned pixel-write instruction is executed. This cycle is indicated by  $\overline{CAS}$ ,  $\overline{TR/QE}$ , and SF high and  $\overline{WE}$  low at the falling edge of  $\overline{RAS}$ , and by SF low at the falling edge of  $\overline{CAS}$ . The data on LAD is written to memory just as a normal DRAM write, except that data in the write mask is used to enable the DQ bits that are written to memory. During the address portion of the cycle, the status on LAD0–LAD3 indicates that a pixel operation is being performed (status code = 1101).

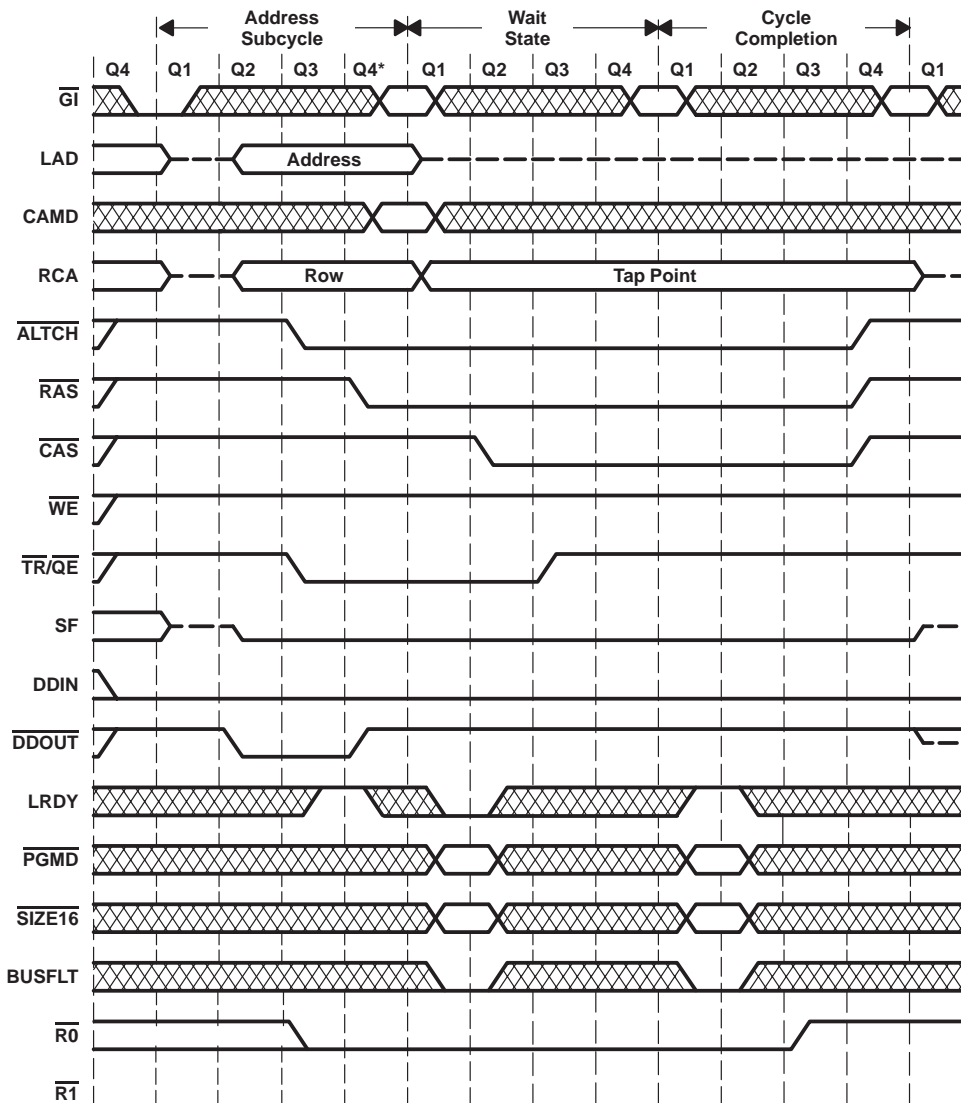

\*See clock stretch, page 21.

**Figure 14. Memory-to-Serial-Data-Register Cycle (VRAM Read Transfer)**

This VRAM cycle is issued in any of three ways:

1. Pixel operation instruction with the CST bit in DPYCTL set.
2. Horizontal blank reload cycle requested by the video-control logic with the VCE bit in DPYCTL cleared.
3. Video timeout due to SCOUNT match with the value in MLRNXT and the VCE and SSV bits in DPYCTL cleared.

This cycle is indicated by  $\overline{TR/QE}$  and SF low and  $\overline{CAS}$  and  $\overline{WE}$  high at the time  $\overline{RAS}$  goes low. The timing of the low-to-high transition of  $\overline{TR/QE}$  is dependent upon the timing of SCLK when doing a midline reload cycle. During the address portion of the cycle, the status on LAD0–LAD3 indicates either a video-initiated VRAM memory-to-register transfer (status code = 0100) or a CPU-initiated VRAM memory-to-register transfer (status code = 0101).

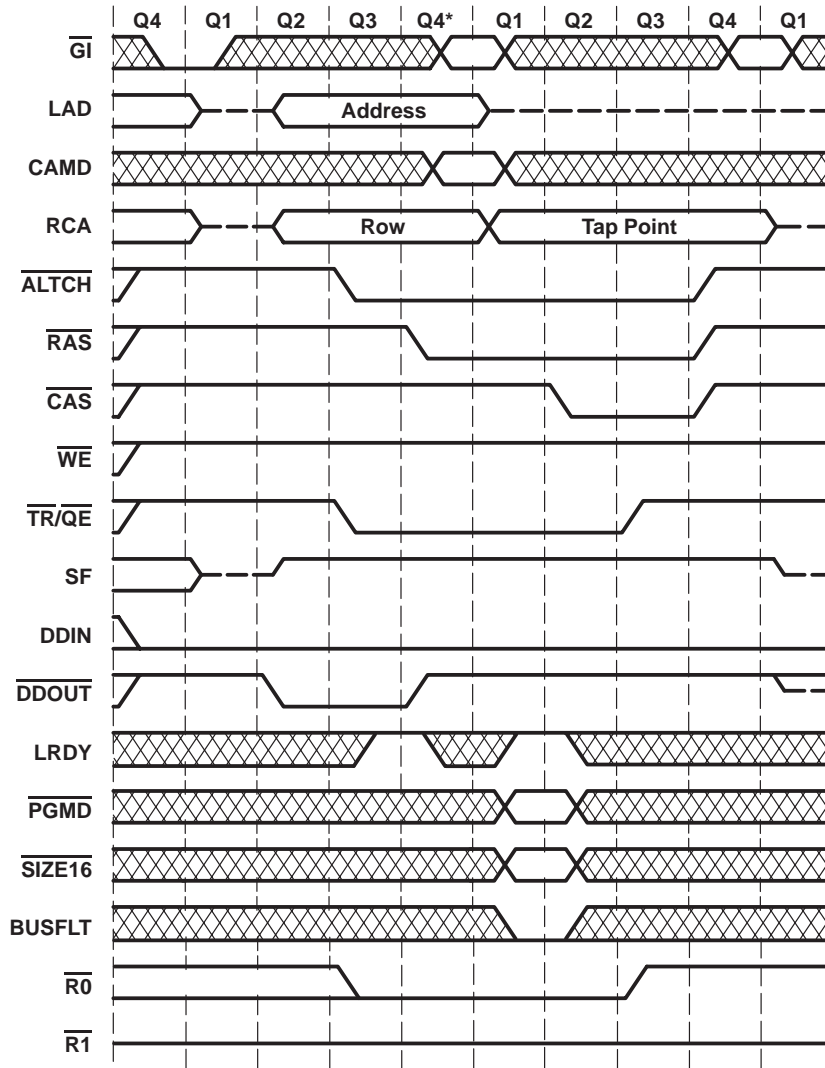

\*See clock stretch, page 21.

**Figure 15. Memory-to-Split-Serial-Data-Register Cycle (VRAM Split-Register Read Transfer)**

This VRAM cycle is performed when a video timeout due to a match of the MLRNXT register occurs, the VCE bit in DPYCTL is cleared, and the SSV bit in DPYCTL is set. This cycle is indicated by  $\overline{TR/QE}$  low and  $\overline{CAS}$ , SF, and  $\overline{WE}$  high at the time  $\overline{RAS}$  goes low. The timing of the low-to-high transition of  $\overline{TR/QE}$  is not dependent upon the timing of SCLK because there is not as great a timing constraint to position the cycle as in midline reload. During the address portion of the cycle, the status on LAD0–LAD3 indicates a video-initiated VRAM memory-to-register transfer (status code = 0100). Although  $\overline{PGMD}$  and  $\overline{SIZE16}$  are ignored on this cycle, they should be held at valid levels as shown.

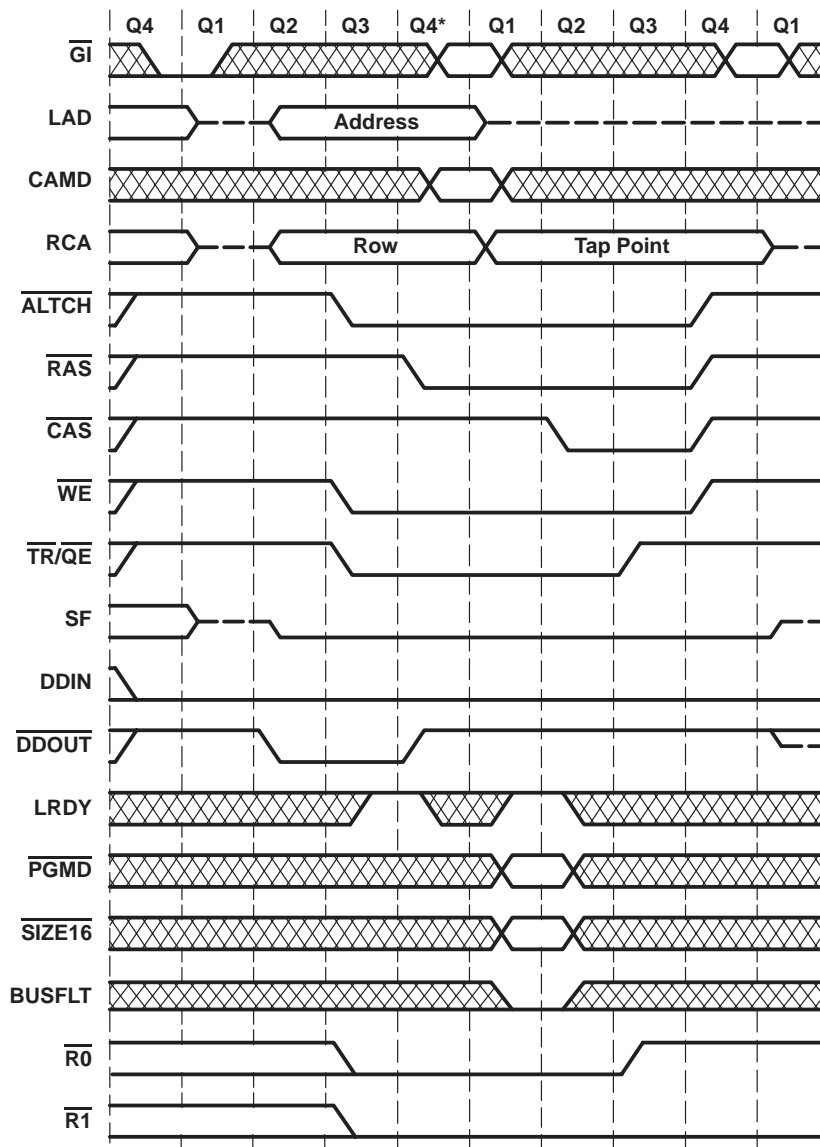

\*See clock stretch, page 21.

**Figure 16. Serial-Data-Register-to-Memory Cycle (VRAM Write Transfer, Pseudo-Write Transfer)**

This VRAM cycle is performed when a horizontal blank reload is requested by the video-control logic and the VCE bit and the SRE bit in DPYCTL are both set. This cycle is indicated by  $\overline{TR/QE}$ ,  $\overline{WE}$  and SF low and  $\overline{CAS}$  high at the time  $\overline{RAS}$  goes low. The  $\overline{SOE}$  pin of the VRAMs is used to select between write transfer and pseudo-write transfer cycles ( $\overline{SOE}$  must be generated by logic external to the TMS34020). During the address portion of the cycle, the status on LAD0–LAD3 indicates that a video-initiated VRAM register-to-memory transfer (status code = 0100) is being performed. Although  $\overline{PGMD}$  and  $\overline{SIZE16}$  are ignored on this cycle, they should be held at valid levels as shown.

# TMS34020, TMS34020A GRAPHICS PROCESSORS

SPVS004D – MARCH 1990 – REVISED NOVEMBER 1993

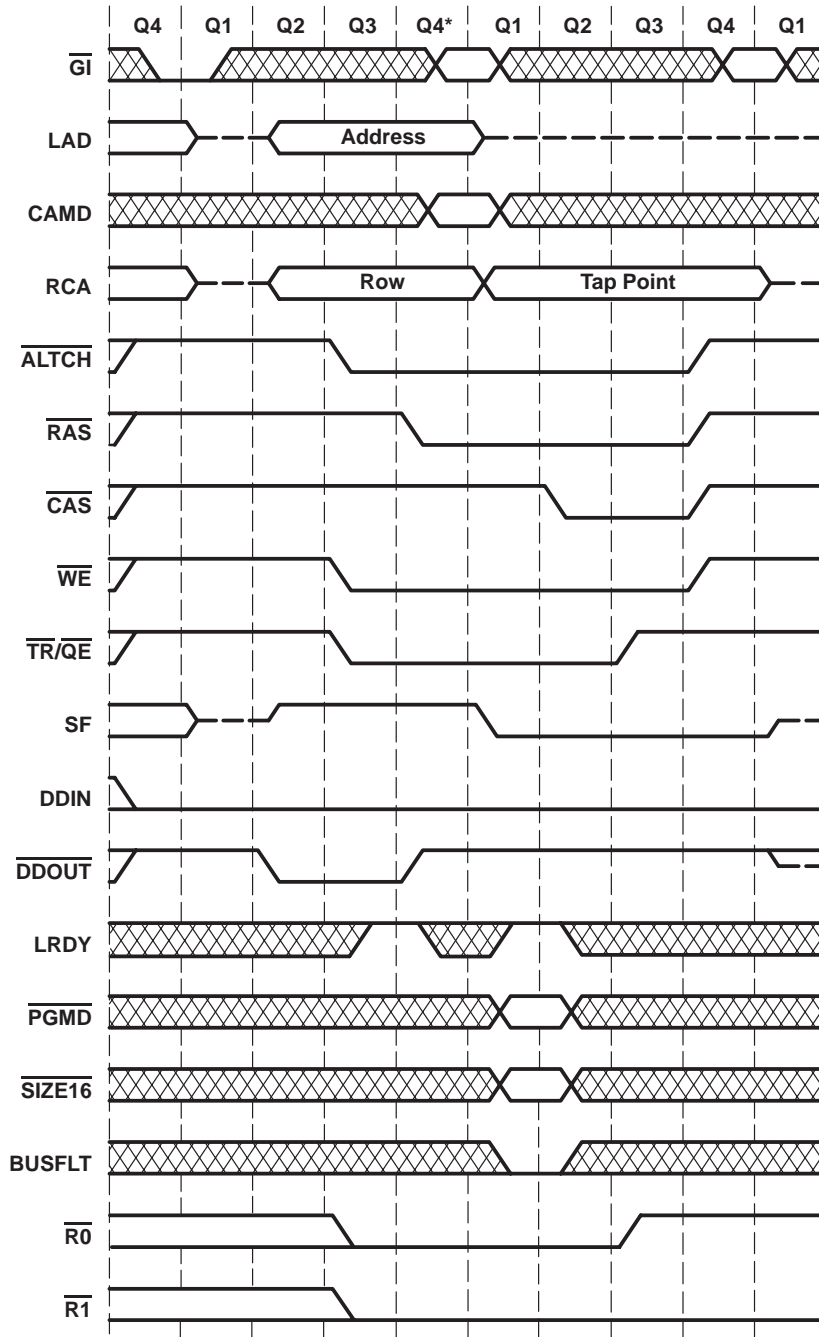

\*See clock stretch, page 21.

**Figure 17. Serial-Data-Register-to-Memory Cycle (VRAM Alternate-Write Transfer)**

This VRAM cycle is performed when a pixel-write instruction is executed with the CST bit in DPYCTL set. This cycle is indicated by  $\overline{\text{TR/QE}}$  and  $\overline{\text{WE}}$  low, and  $\overline{\text{CAS}}$  high at the time  $\overline{\text{RAS}}$  goes low. This cycle does not require the use of the  $\overline{\text{SOE}}$  pin of the VRAM and does not affect the status of the serial I/O pins. During the address portion of the cycle, the status on LAD0–LAD3 indicates that a CPU-initiated VRAM register-to-memory transfer (status code = 0101) is being performed. Although  $\overline{\text{PGMD}}$  and  $\overline{\text{SIZE16}}$  are ignored on this cycle, they should be held at valid levels as shown.



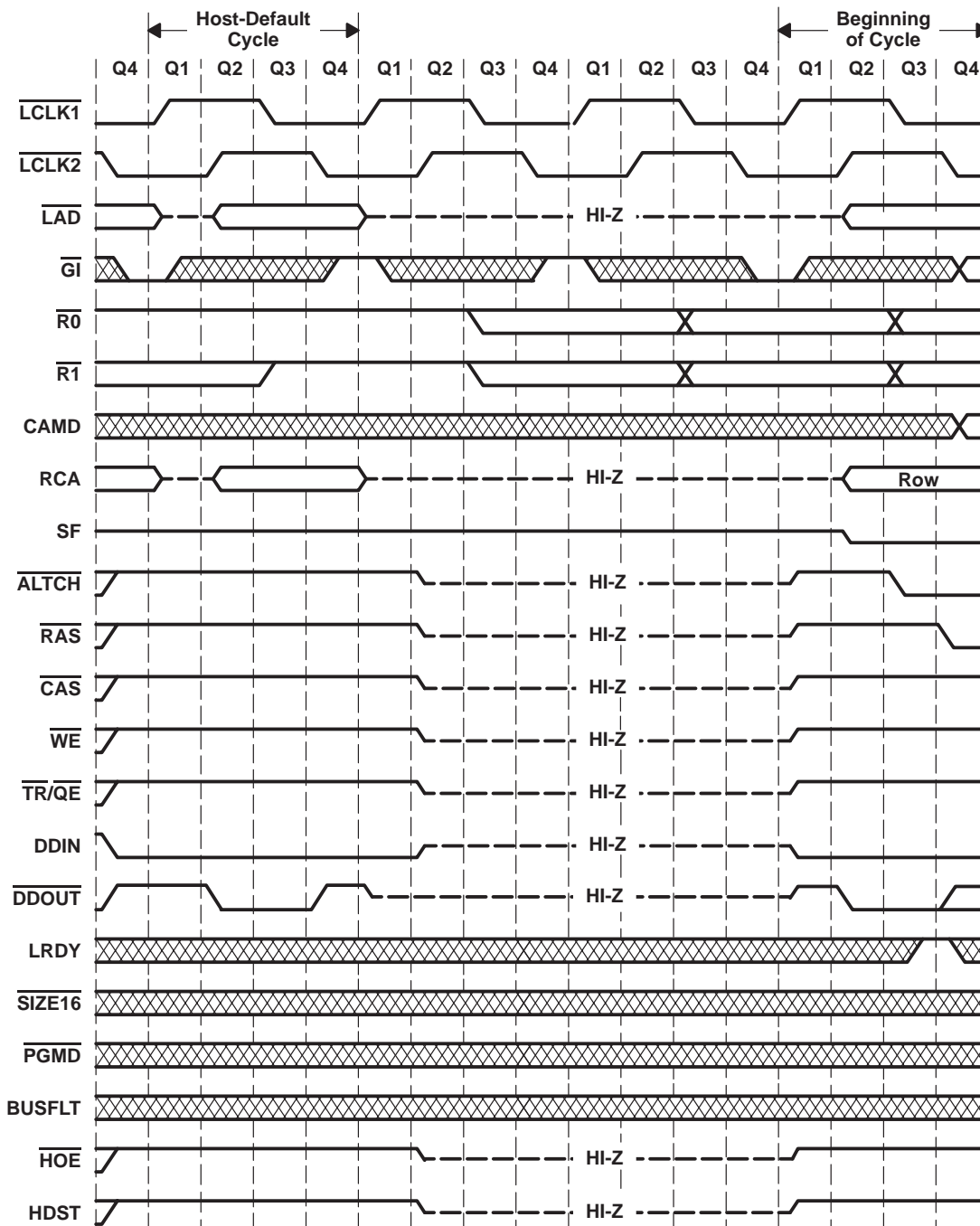

Figure 18. Multiprocessor Interface Timing (High-Impedance Signals)

Transition points are shown for  $\overline{R0}$  and  $\overline{R1}$  to indicate where they occur relative to the other signals.

This example indicates that the TMS34020 has control of the bus, yields control, and then regains control. The TMS34020 regains bus mastership as soon as its  $\overline{GI}$  pin is driven active (low).  $\overline{R0}$  and  $\overline{R1}$  could be outputting any of the codes with the exception of the access-termination code. The bus arbitration logic must control the timing of  $\overline{GI}$  to all of the processors requiring the bus.

*It is recommended that TMS34020A clock stretch not be used in multiprocessor systems.*

# TMS34020, TMS34020A GRAPHICS PROCESSORS

SPVS004D – MARCH 1990 – REVISED NOVEMBER 1993

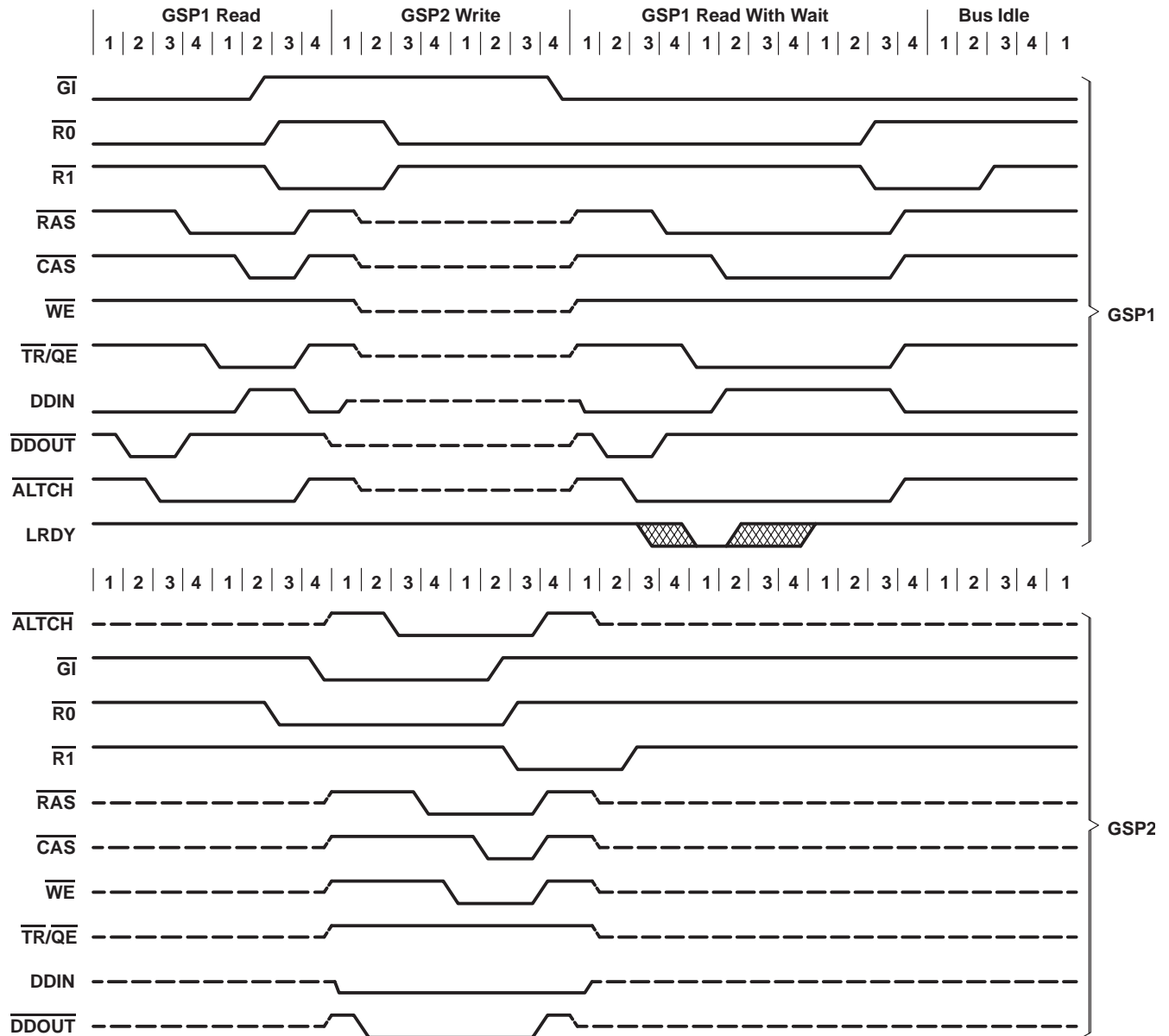

**Figure 19. Multiprocessor Interface Timing (Passing Control)**

Two TMS34020s use the multiprocessor interface to pass control of local memory from one to the other. GSP1 completes a read cycle to the local memory and, although desiring another read, loses the bus to GSP2, which does a single write cycle (perhaps a host-write access). GSP1 then regains control and completes the read cycle (shown with a single wait state). Since no further memory-access requests are present, GSP1 maintains control of the bus and holds all of the local-memory control signals at their inactive levels.  $\overline{LRDY}$  is a common input to both GSP1 and GSP2.

The host cycle timing diagrams shown in this data sheet are only a sample. If you want more information, see the *TMS34020 User's Guide*.

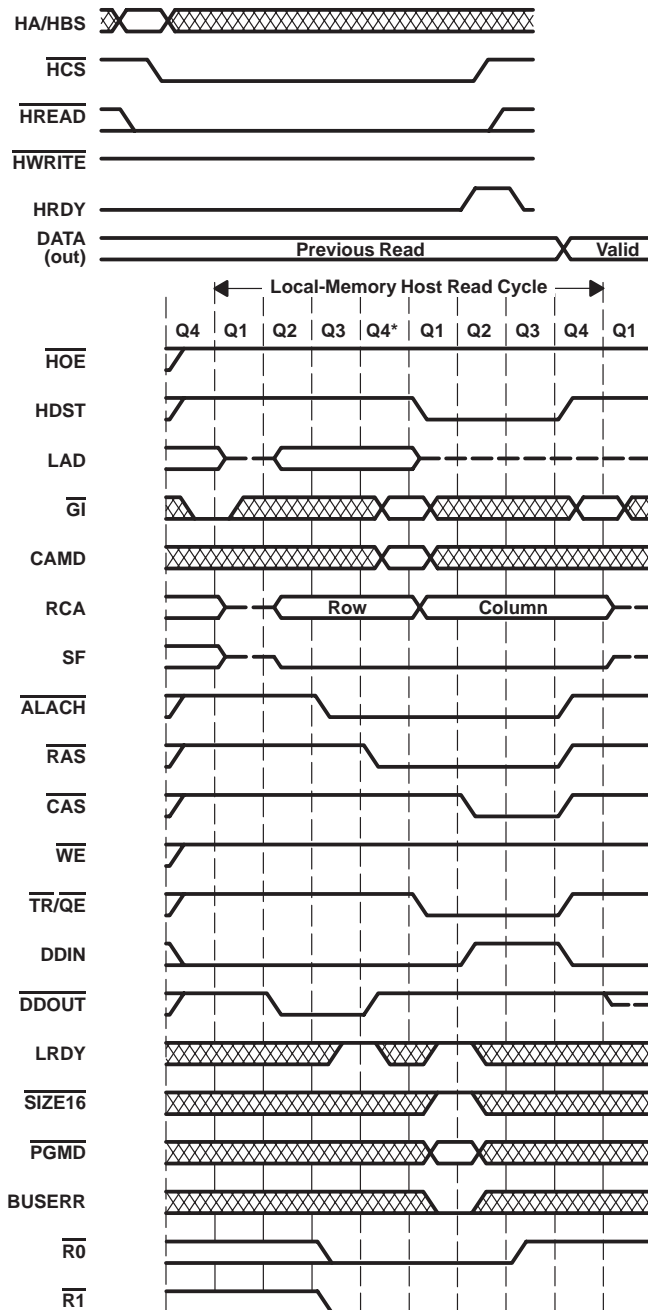

\*See clock stretch, page 21.

NOTE A: HRDY goes high at the start of Q2; however, data is not strobed into the external latches until the start of Q4 by HDST going high.

**Figure 20. Host Read Cycle (Random/Same Accesses, not From TMS34020 I/O Registers)**

The host-access request is synchronized to the TMS34020 at the beginning of Q4 so that the local memory cycle can begin in Q1. If the external host-access request occurs after the setup time requirement before Q4, the request is not considered until the next Q4 cycle. In order to provide back-to-back accesses as indicated in this example, the host must remove HCS on receipt of HRDY and reassert it before Q4 (it may also remove and reassert HREAD with HCS).

# TMS34020, TMS34020A GRAPHICS PROCESSORS

SPVS004D – MARCH 1990 – REVISED NOVEMBER 1993

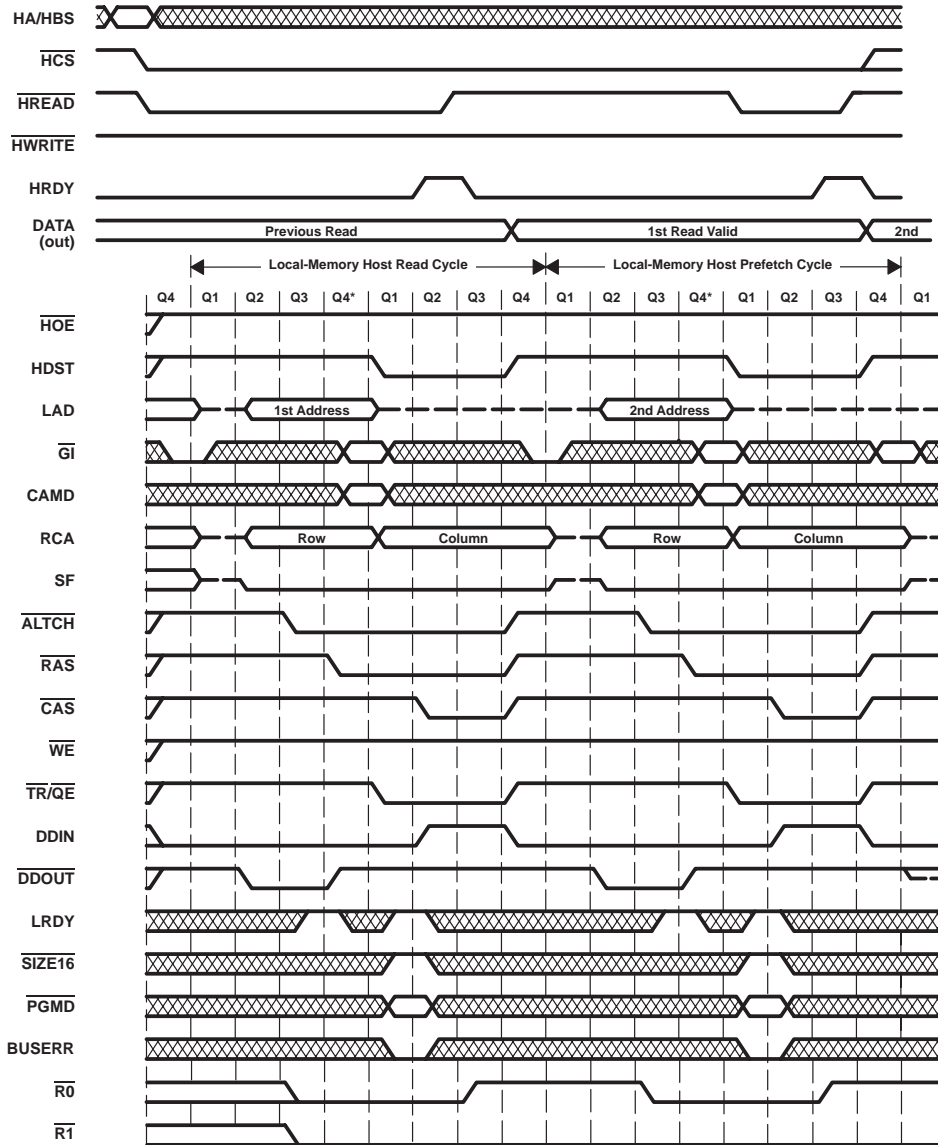

\*See clock stretch, page 21.

**Figure 21. Back-to-Back Host Read Cycles With Implicit Addressing;  $\overline{\text{HREAD}}$  as Strobe**

The host-access request is synchronized to the TMS34020 at the beginning of Q4 so that the local memory cycle may begin in Q1.

In block mode (prefetch after read), the TMS34020 automatically initiates sequential read accesses as soon as the host deasserts the current read request. In this example, the host reads a location and must wait for the first access to complete. When the host removes  $\overline{\text{HREAD}}$ , indicating the end of the first read, the TMS34020 starts to prefetch the next sequential location. When the host makes the next request, the TMS34020 has prefetched the data so that the host reads with no delay. While in block mode, the TMS34020 continues to prefetch data for the host read each time the host removes either  $\overline{\text{HREAD}}$  or  $\overline{\text{HCS}}$ . If the address present and latched at the falling edge of  $\overline{\text{HCS}}$  matches the previously prefetched address, the  $\overline{\text{HRDY}}$  signal is asserted high so that the host can read with no delay.

In read/modify/write mode (prefetch after write), the TMS34020 initiates the read access as soon as the current write request is deasserted.

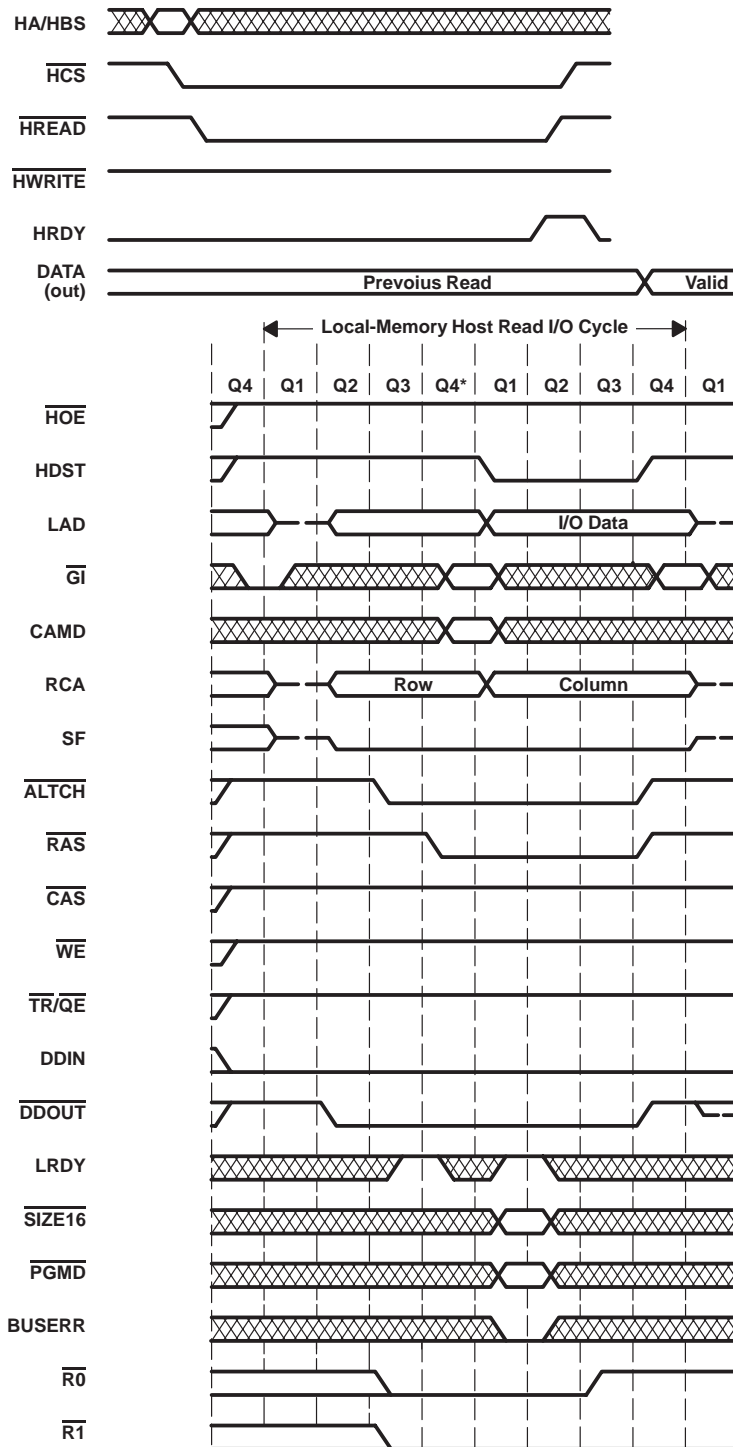

\*See clock stretch, page 21.

**Figure 22. Host Read Cycle From TMS34020 I/O Registers**

The host read of the TMS34020 I/O registers suppresses the generation of  $\overline{TR/QE}$  and  $\overline{CAS}$  so that data is read from the TMS34020 rather than from memory.  $\overline{DDOUT}$  is enabled so that data CAN flow through external buffers on the LAD bus to the host data latches. The TMS34020 I/O registers may be accessed in any of the host access modes (random/same, block, or read/modify/write).

# TMS34020, TMS34020A GRAPHICS PROCESSORS

SPVS004D – MARCH 1990 – REVISED NOVEMBER 1993

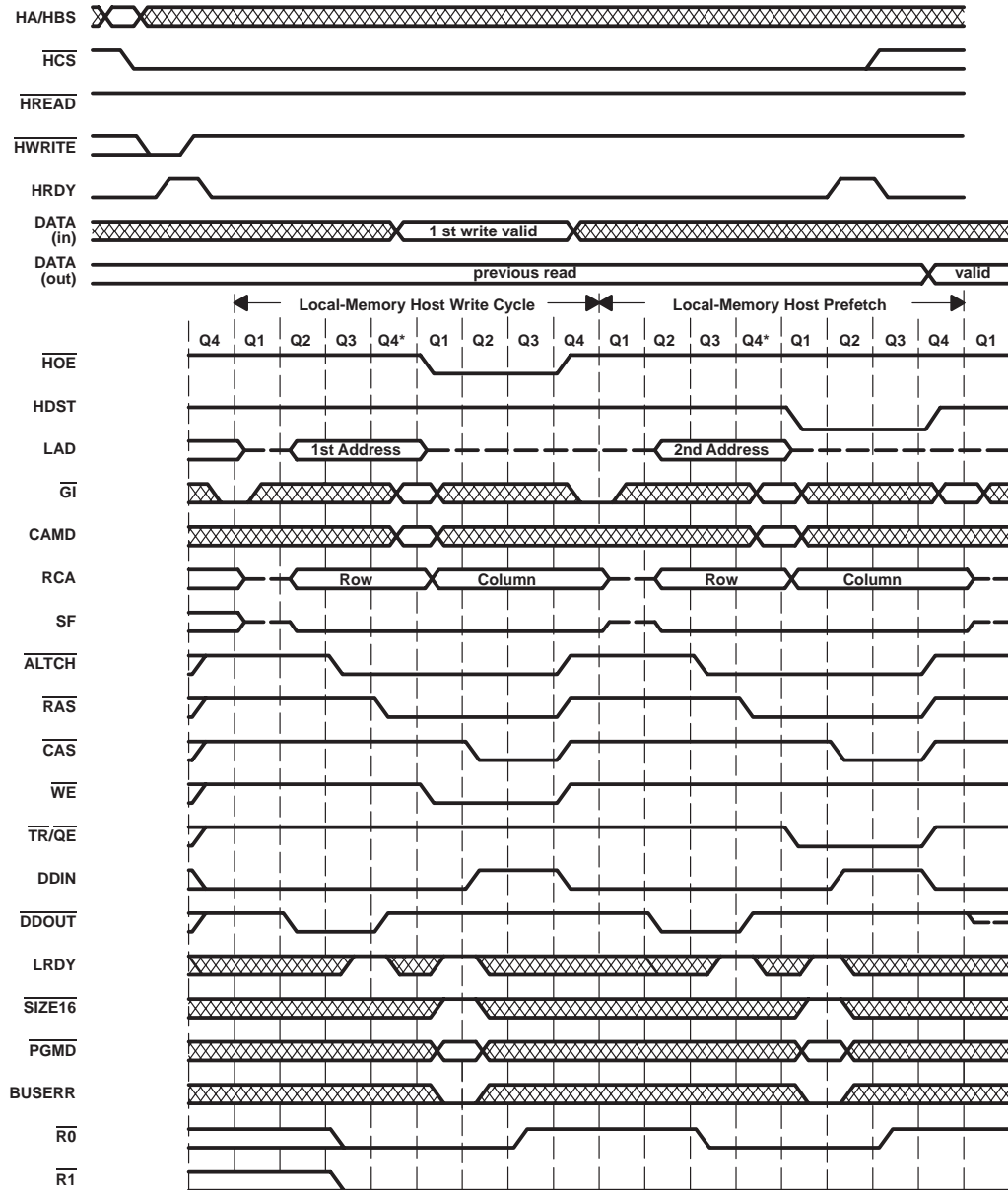

\*See clock stretch, page 21.

NOTE A:  $\overline{\text{HRDY}}$  goes high at the start of Q2; however, the memory cycle writing data to memory is not completed until the start of Q4 when  $\overline{\text{ALTCH}}$ ,  $\overline{\text{CAS}}$ , and  $\overline{\text{HOE}}$  return high. The host must not strobe new data into the external latch until just after the start of Q4.

**Figure 23. Host Write Cycle Back-to-Back With Prefetch of Next Word and Implicit Addressing;  $\overline{\text{HREAD}}$  and  $\overline{\text{HWRITE}}$  Used as Strobes**

The TMS34020 provides  $\overline{\text{HRDY}}$  as soon as it recognizes the host write cycle (if no other host write cycle is in progress), allowing the host to latch the data in the external data latches. The host then attempts a second write but does not get an immediate  $\overline{\text{HRDY}}$  because the TMS34020 is still writing the first data to memory. As soon as the memory write completes,  $\overline{\text{HRDY}}$  goes high so that the host can latch the new data. The TMS34020 then writes the second data while the host continues other processing. The host access request is synchronized to the TMS34020 at the beginning of Q4 so that the local memory cycle can begin in Q1. If the external host access request occurs after the setup time requirement before Q4, the request is not considered until the next Q4 cycle. During a host write cycle  $\overline{\text{DDIN}}$  is active so that if the write is to the TMS34020 I/O registers, the data can be required within the GSP.

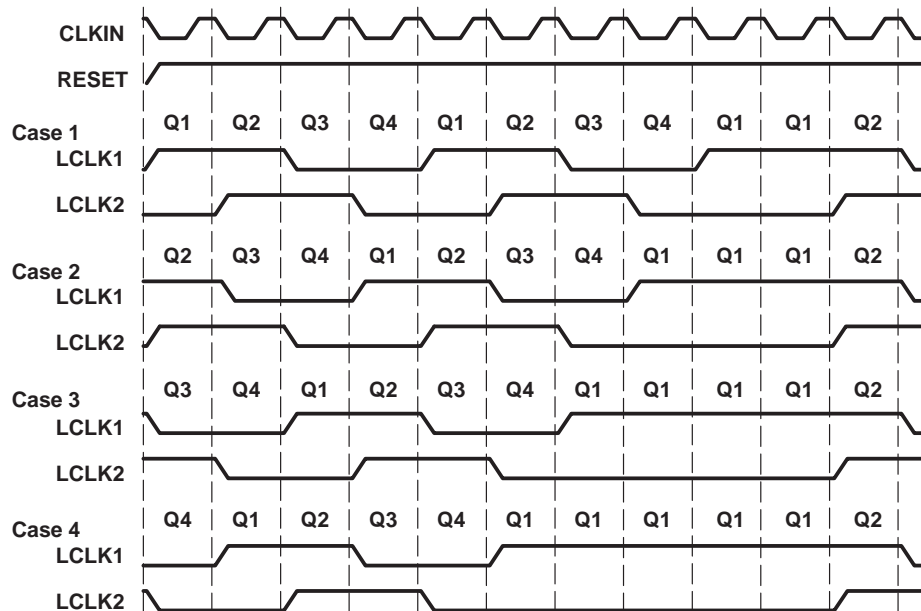

NOTE A: No timing dependencies of LCLK1 and LCLK2 relative to CLKIN or  $\overline{\text{RESET}}$  are to be implied from this figure.

**Figure 24. Synchronization of Multiple TMS34020s**

Although  $\overline{\text{RESET}}$  is not normally required to be synchronous to CLKIN, in order to facilitate synchronization of multiple TMS34020s in a system, the rising edge of  $\overline{\text{RESET}}$  must meet the setup and hold requirements to CLKIN so that all GSPs are certain to respond to the  $\overline{\text{RESET}}$  on the same quarter cycle. The four possible conditions for the state of the TMS34020 at the time  $\overline{\text{RESET}}$  goes high are shown above. Quarter cycle 1 is extended accordingly to provide synchronization of the GSPs. All TMS34020s to be synchronized must share a common CLKIN and  $\overline{\text{RESET}}$ . Within 10 CLKIN cycles after  $\overline{\text{RESET}}$  goes high, all GSPs will be synchronized to the same quarter cycle through the extension of Q1 cycles.

*It is recommended that TMS34020A stretch mode not be used in multiprocessor systems.*

# TMS34020, TMS34020A GRAPHICS PROCESSORS

SPVS004D – MARCH 1990 – REVISED NOVEMBER 1993

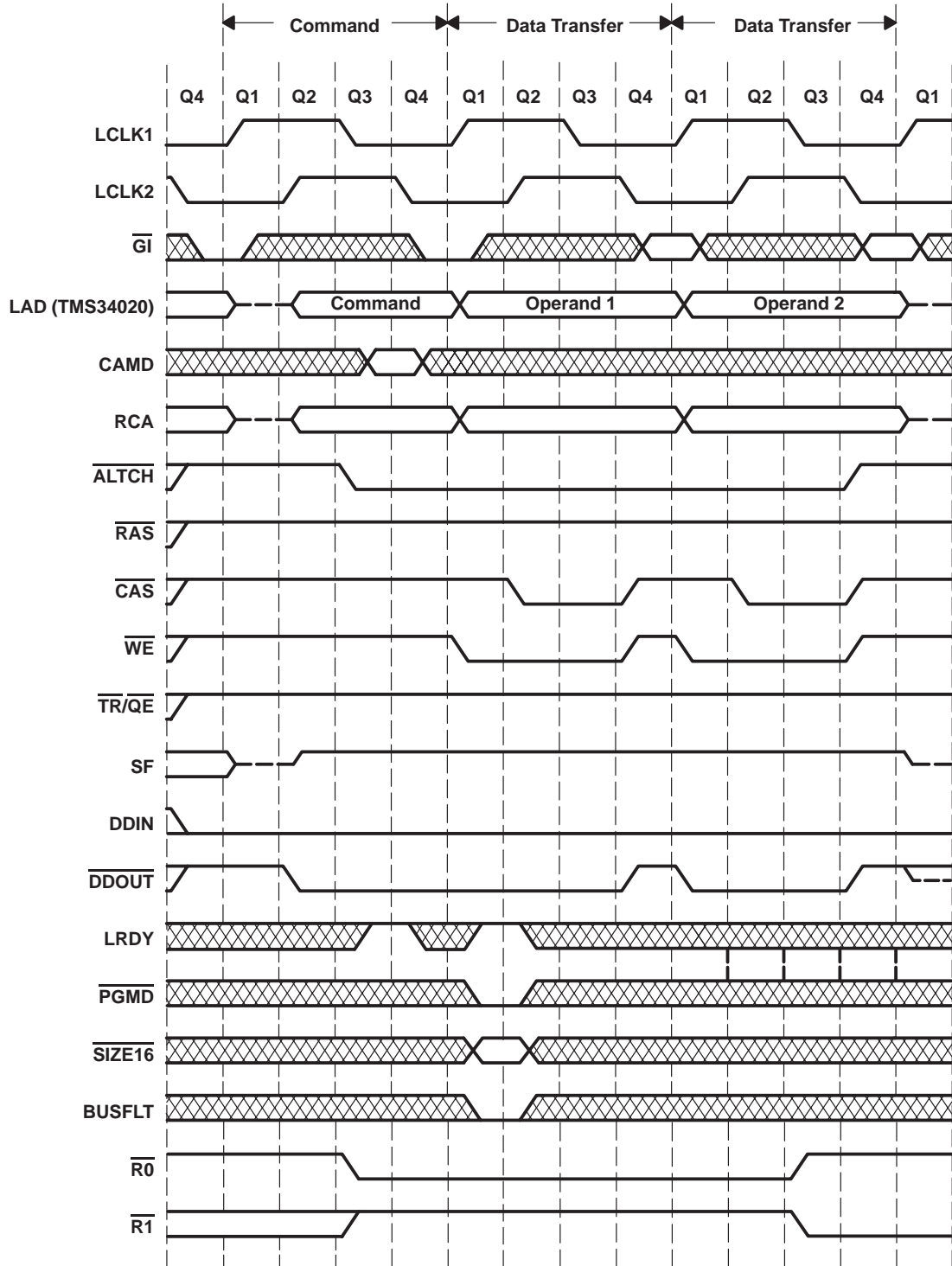

NOTE A: LAD (TMS34020): Output to the LAD bus by the TMS34020  
 Command: Coprocessor ID, instruction and status code present on LAD  
 Operand n: Data to or from the coprocessor

**Figure 25. Transfer TMS34020 Register(s) to Coprocessor (One or Two 32-Bit Values)**

This timing example is like a memory write cycle, except that  $\overline{\text{RAS}}$  and SF are high.



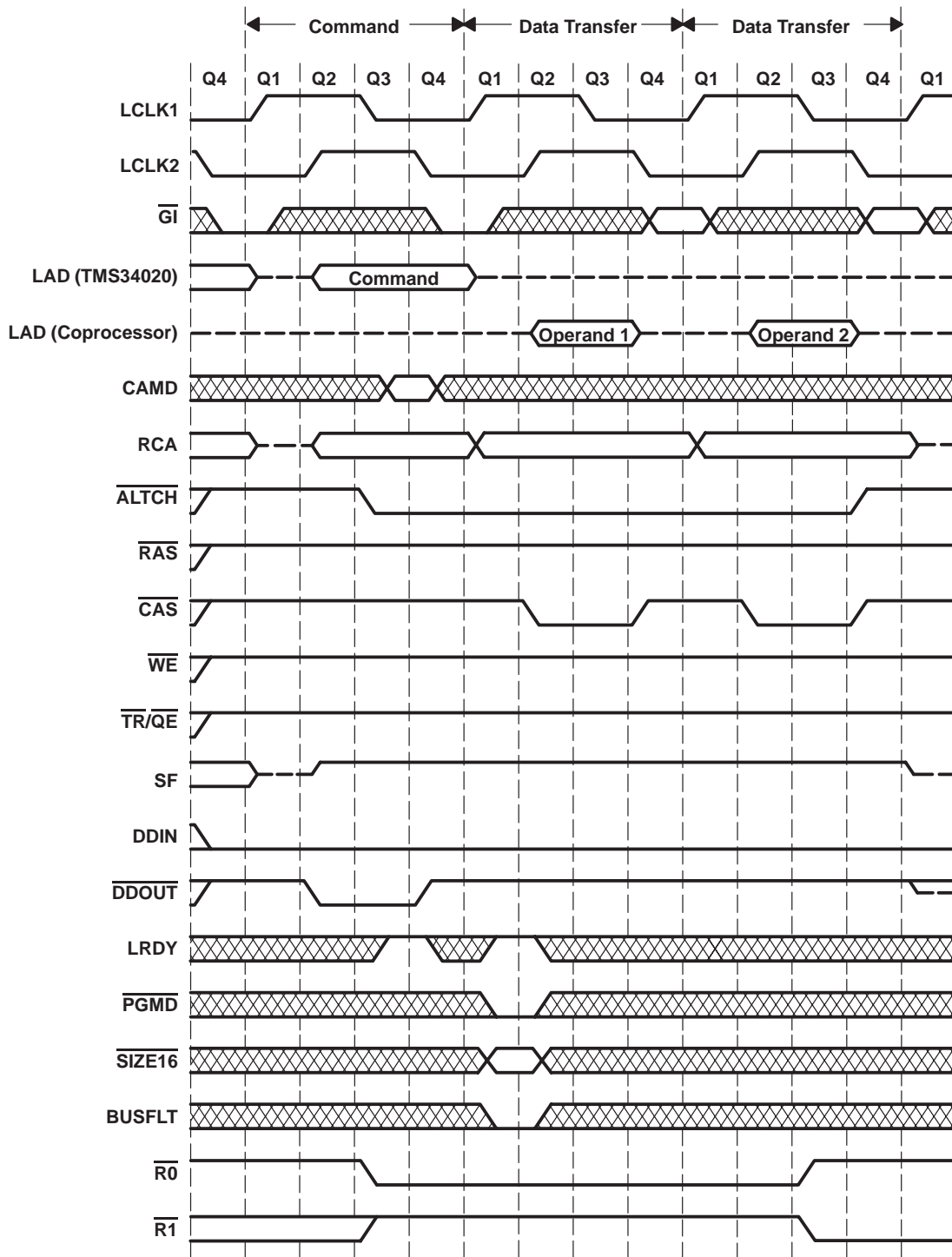

NOTE A: LAD (TMS34020): Output to the LAD bus by the TMS34020  
 LAD (coprocessor): Output to the LAD bus by the coprocessor  
 Command: Coprocessor ID, instruction and status code present on LAD  
 Operand n: Data to or from the coprocessor

**Figure 26. Transfer Coprocessor Register to TMS34020 (One or Two 32-Bit Values)**

This timing example is like a memory write cycle, except that  $\overline{RAS}$  and SF are high.

# TMS34020, TMS34020A GRAPHICS PROCESSORS

SPVS004D – MARCH 1990 – REVISED NOVEMBER 1993

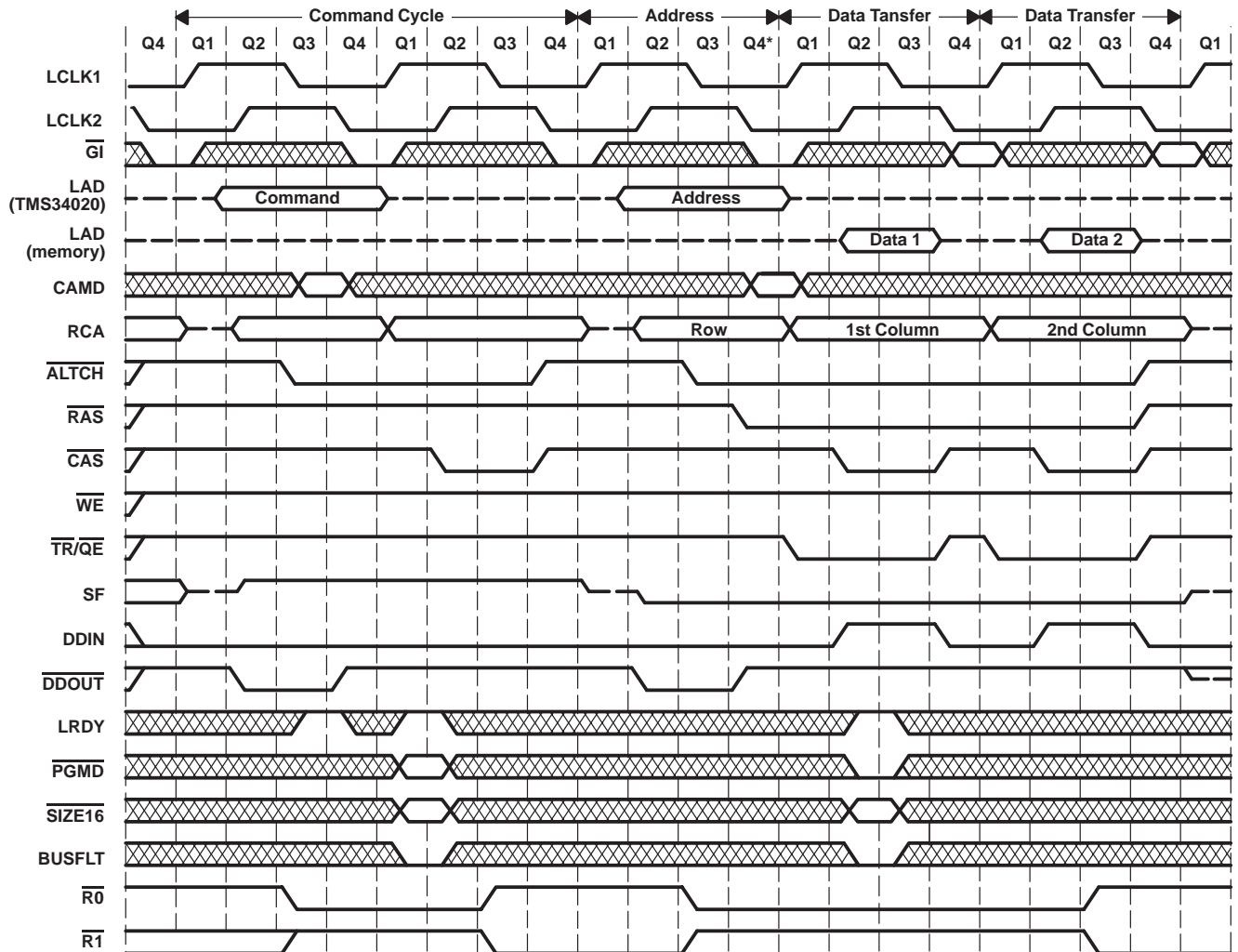

\*See clock stretch, page 21.

- NOTES: A. LAD (TMS34020): Output to the LAD bus by the TMS34020  
 LAD (memory): Output to the LAD bus by the memory  
 Command: Coprocessor ID, instruction and status code present on LAD  
 Address: Memory address for the data transfer, with coprocessor status code  
 Data n: Data to or from the coprocessor (number of values transferred depends on a value in a register or count in the instruction)
- B. All coprocessor cycles are implemented as 32-bit operations; therefore SIZE16 should be high during these cycles.

**Figure 27. Transfer Memory to Coprocessor Register(s)**

Data transfer from memory to a coprocessor requires an initialization cycle to inform the coprocessor what is to be transferred and then a memory cycle to perform the actual transfer. The coprocessor can place status information on the LAD bus during the initialization cycle for the TMS34020. Two types of memory-to-coprocessor instructions are supported: one provides a count (from 1 to 32) of data to be moved in the instruction; the other specifies a register in the TMS34020 to be used for the count. Both instructions specify a register to be used as an index into memory. The index may be post-incremented or pre-decremented on each transfer cycle.

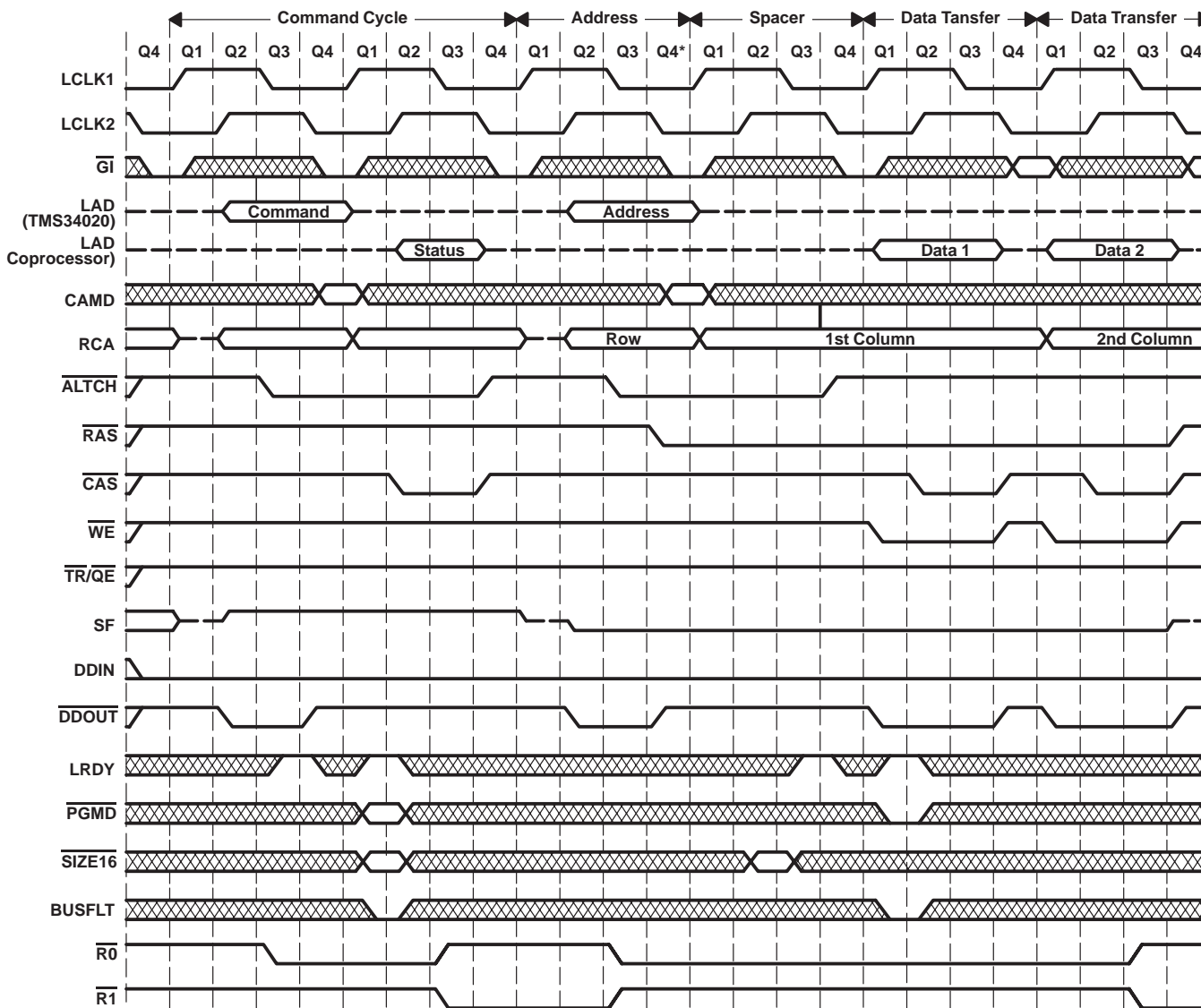

\*See clock stretch, page 21.

- NOTES: A. All coprocessor cycles are implemented as 32-bit operations; therefore,  $\overline{\text{SIZE16}}$  should be high during these cycles.
- B. LAD (TMS34020): Output to the LAD bus by the TMS34020  
 LAD (coprocessor): Output to the LAD bus by the coprocessor  
 Command: Coprocessor ID, instruction and status code present on LAD  
 Address: Memory address for the data transfer, with coprocessor status code  
 Data n: Data from the coprocessor (number of values transferred depends on a count in the instruction)  
 Status: Optional coprocessor status register output to LAD bus

**Figure 28. Transfer Coprocessor Register(s) to Memory ( $\overline{\text{ALTCH}}$  High During Data Transfer)**

Data transfer from a coprocessor to memory requires an initialization cycle to inform the coprocessor what is to be transferred and then a memory cycle to perform the actual transfer. The coprocessor can place status information on the LAD bus during the initialization cycle for the TMS34020. The memory cycle includes a dead cycle to enable the TMS34020 to take the LAD bus drivers to the high-impedance state before the coprocessor activates its LAD bus drivers to the memory. Two types of memory-to-coprocessor instructions are supported. Both provide a count (from 1 to 32) of data to be moved in the instruction. Both also specify a register to be used as an index into memory. One uses this index register with a post-increment and the other uses it with a pre-decrement after each transfer cycle.

# TMS34020, TMS34020A GRAPHICS PROCESSORS

SPVS004D – MARCH 1990 – REVISED NOVEMBER 1993

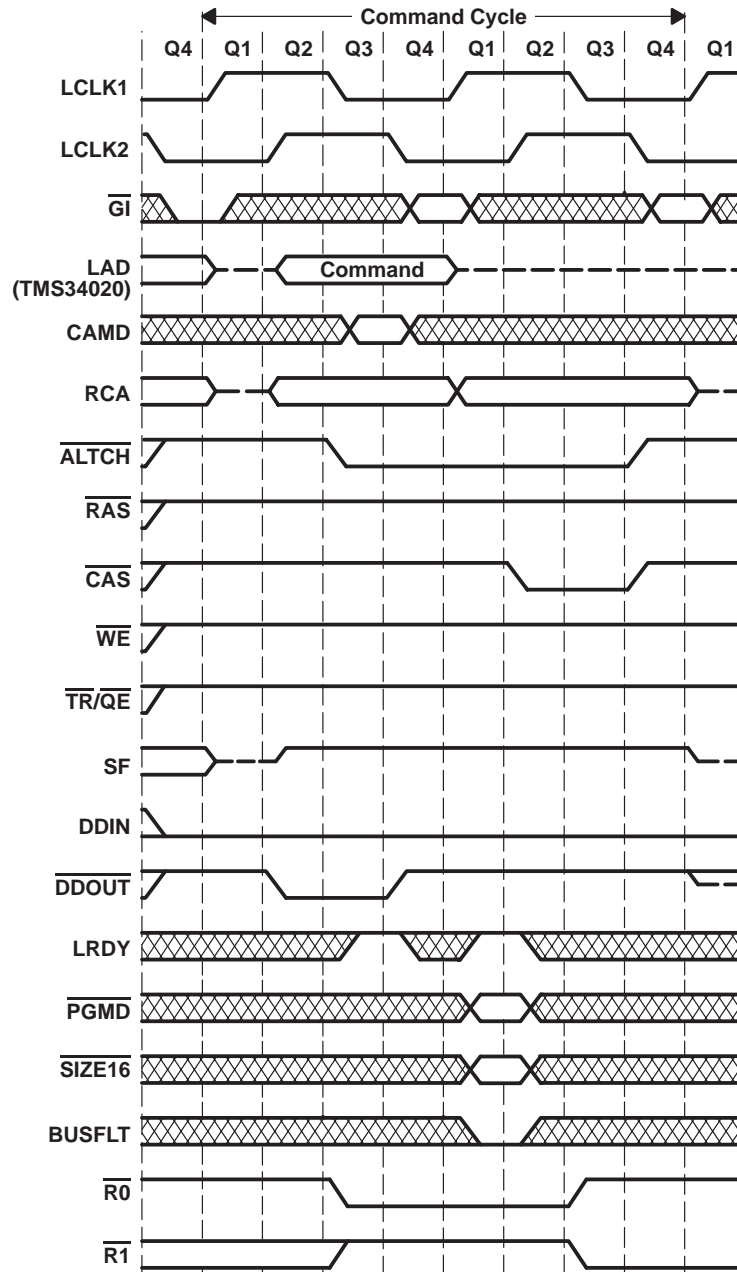

- NOTES:
- A. All coprocessor cycles are implemented as 32-bit operations; therefore,  $\overline{\text{SIZE16}}$  should be high during these cycles.
  - B. LAD (TMS34020): Output to the LAD bus by the TMS34020  
command: Coprocessor ID, instruction and status code present on LAD
  - C. Although the coprocessor internal command never requires the use of page mode cycles,  $\overline{\text{PGMD}}$  should be held at a valid level during the start of Q2 after ALTCH has gone low.

**Figure 29. Coprocessor Internal Operation Command Cycle**

This timing example is like a memory write cycle, except that  $\overline{\text{RAS}}$  and SF are high.

A coprocessor internal command assumes no transfer of operands or results but causes the coprocessor to execute some internal function. The coprocessor can place status information on the LAD bus during the cycle for the TMS34020.

## absolute maximum ratings over operating free-air temperature range (see Note 1)†

Maximum supply voltage, $V_{CC}$ .....	7 V
Input voltage range .....	– 0.3 V to 7 V
Off-state output voltage range .....	– 2 V to 7 V
Operating free-air temperature range .....	0°C to 70°C
Storage temperature range .....	– 10°C to 150°C

† Stresses beyond those listed under “absolute maximum ratings” may cause permanent damage to the device. These are stress ratings only and functional operation of the device at these or any other conditions beyond those indicated under “recommended operating conditions” is not implied. Exposure to absolute-maximum-rated conditions for extended periods may affect device reliability.

NOTE 1: Voltage values are with respect to  $V_{SS}$ .

## recommended operating conditions

		MIN	NOM	MAX	UNIT	
$V_{CC}$	Supply voltage	4.75	5	5.25	V	
$V_{SS}$	Supply voltage‡	0	0	0	V	
$V_{IH}$	High-level input voltage	All input pins except CLKIN		$V_{CC} + 0.3$	V	
		CLKIN only		$V_{CC} + 0.3$		
$V_{IL}$	Low-level input voltage	– 0.3		0.8	V	
$I_{OH}$	High-level output current			400	μA	
$I_{OL}$	Low-level output current			2	mA	
$T_A$	Operating free-air temperature	TMS34020AGBL40		0	70	°C
$T_C$	Operating case temperature	TMS34020APCM40		0	85	°C

‡ Take care to provide a minimum inductance path between the  $V_{SS}$  pins and system ground in order to minimize noise on  $V_{SS}$ .

## electrical characteristics over recommended ranges of supply voltage and operating free-air temperature

PARAMETER		TEST CONDITIONS	MIN	TYP§	MAX	UNIT
$V_{OH}$	High-level output voltage	$V_{CC} = \text{MIN}, I_{OH} = \text{MAX}$	2.6			V
$V_{OL}$	Low-level output voltage	$V_{CC} = \text{MAX}, I_{OL} = \text{MIN}$			0.6	V
$I_O$	Output current, leakage (high-impedance)	$V_{CC} = \text{MAX}, V_O = 2.8 \text{ V}$			20	μA
		$V_{CC} = \text{MAX}, V_O = 0.6 \text{ V}$			– 20	
$I_I$	Input current, leakage (All input pins except EMU0–EMU2¶)	$V_I = V_{SS} \text{ to } V_{CC}$			±20	μA
$I_{CC}$	Supply current	$V_{CC} = \text{MAX}$			260	mA
$C_i$	Input capacitance			10		pF
$C_o$	Output capacitance			10		pF

§ All typical values are at  $V_{CC} = 5 \text{ V}, T_A = 25^\circ \text{ C}$ .

¶ EMU0–EMU2 will not be connected in a typical configuration. Nominal pullup current will be 500 μA.

NOTE 2: HDST and HOE (output pins) have internal pullup resistors that allow high logic levels to be maintained when the TMS34020 is not actually driving these pins.

PARAMETER MEASUREMENT INFORMATION

signal transition levels



Figure 30. TTL-Level Inputs

For a high-to-low transition on a TTL-compatible input signal, the level at which the input is said to be no longer high is 2 V, and the level at which the input is said to be low is 0.8 V. For a low-to-high transition, the level at which the input is said to be no longer low is 0.8 V, and the level at which the input is said to be high is 2 V.

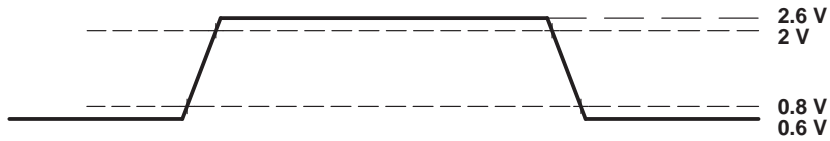

Figure 31. TTL-Level Outputs

TTL-level outputs are driven to a minimum logic-high level of 2.6 V and to a maximum logic-low level of 0.6 V. For a high-to-low transition on a TTL-compatible output signal, the level at which the output is said to be no longer high is 2 V, and the level at which the output is said to be low is 0.8 V. For a low-to-high transition, the level at which the output is said to be no longer low is 0.8 V, and the level at which the output is said to be high is 2 V.

Timing parameters 12a and 13a do not follow these conventions. They are measured at a 1.5-V level.

test measurement

The test load circuit shown in Figure 32 represents the programmable load of the tester pin electronics, which are used to verify timing parameters of TMS34020 output signals.

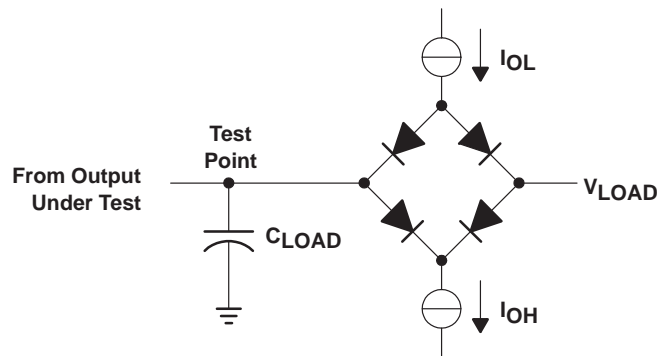

Where:  $I_{OL} = 2 \text{ mA}$  (all outputs)  
 $I_{OH} = 400 \mu\text{A}$  (all outputs)  
 $V_{LOAD} = 1.5 \text{ V}$   
 $C_{LOAD} = 65 \text{ pF}$  typical load circuit distributed capacitance

Figure 32. Test Load Circuit

PARAMETER MEASUREMENT INFORMATION

timing parameter symbology

Timing parameter symbols used herein were created in accordance with JEDEC Standard 100. In order to shorten the symbols, some of the pin names and other related terminology have been abbreviated as follows:

A	HA5–HA31 and $\overline{\text{HBS0}}\text{--}\overline{\text{HBS3}}$	GI	$\overline{\text{G1}}$
AD	LAD0–LAD31 and RCA0–RCA12	LA	LAD0–LAD31
AL	$\overline{\text{ALTCH}}$	LINT	$\overline{\text{LINT1}}$ , $\overline{\text{LINT2}}$
BC	Any of the bus control input signals ( $\overline{\text{LRDY}}$ , $\overline{\text{PGMD}}$ , $\overline{\text{SIZE16}}$ , or $\overline{\text{BUSFLT}}$ )	OE	$\overline{\text{HOE}}$
CE	$\overline{\text{CAS0}}\text{--}\overline{\text{CAS3}}$	RC	RCA0–RCA12
CK	LCLK1 and LCLK2	RD	$\overline{\text{HREAD}}$
CK1	LCLK1	RE	$\overline{\text{RAS}}$
CK2	LCLK2	RQ	$\overline{\text{R0}}$ or $\overline{\text{R1}}$
CKI	CLKIN	RS	$\overline{\text{RESET}}$
CM	$\overline{\text{CAMD}}$	RY	HRDY
CS	$\overline{\text{HCS}}$		
CT	Any of the bus control output signals ( $\overline{\text{ALTCH}}$ , $\overline{\text{CAS0}}\text{--}\overline{\text{CAS3}}$ , $\overline{\text{RAS}}$ , $\overline{\text{WE}}$ , $\overline{\text{TR/QE}}$ , $\overline{\text{HOE}}$ , or $\overline{\text{HDST}}$ )	S	$\overline{\text{HSYNC}}$ , $\overline{\text{VSYNC}}$ , or $\overline{\text{CSYNC}}$
DI	$\overline{\text{DDIN}}$	SC	EMU3
DO	$\overline{\text{DDOUT}}$	SCK	SCLK
EM	EMU0, EMU1, EMU2	SF	SF
HI	$\overline{\text{HINT}}$	SG	Any output signal
HS	$\overline{\text{HSYNC}}$ , $\overline{\text{VSYNC}}$ , $\overline{\text{CSYNC/HBLNK}}$ , or $\overline{\text{CBLNK/VBLNK}}$	ST	HDST
		TR	$\overline{\text{TR/QE}}$
		VCK	VCLK
		WR	$\overline{\text{HWRITE}}$

Lowercase subscripts and their meaning are:

a	access time
c	cycle time (period)
d	delay time
h	hold time
su	setup time
t	transition time
w	pulse duration (width)

The following letters and symbols and their meaning are:

H	High	s = 0	For (i) TMS34020
L	Low		(ii) TMS34020A, if CSE bit in CONFIG register is set to 0
NV	Not valid		(iii) TMS34020A, if CSE bit in CONFIG register is set to 1 and the cycle is <i>not</i> stretched. See page 21.
V	Valid		
Z	High impedance		
↑	No longer low		
↓	No longer high	s = t <sub>Q</sub>	For TMS34020A, if CSE bit in CONFIG register is set to 1 and the cycle is stretched. See page 21.
D	Driven		

## PARAMETER MEASUREMENT INFORMATION

### general notes on timing parameters

The period of the local clocks (LCLK1 and LCLK2) is four times the period of the input clock (CLKIN).

The quarter cycle time ( $t_Q$ ) that appears in the following tables is one quarter of a local output clock period, or equal to the input clock period,  $t_c(\text{CKI})$ .

All output signals from the TMS34020 are derived from an internal clock such that all output transitions for a given quarter cycle occur with a minimum of skewing relative to each other. In the timing diagrams, the transitions of all output signals are shown with respect to the local clocks (LCLK1 and LCLK2). The local clock edge used as a reference occurs one internal clock cycle before the transition specified.

The signal combinations shown in the timing parameters are for timing reference only; they do not necessarily represent actual cycles. For actual cycle descriptions, please refer to the cycle timings section of this specification.



PARAMETER MEASUREMENT INFORMATION

CLKIN and  $\overline{\text{RESET}}$  timing requirements

NO.	PARAMETER		'34020-32 '34020A-32		'34020A-40		UNIT
			MIN	MAX	MIN	MAX	
1	$t_c(\text{CKI})$	Period of CLKIN ( $t_Q$ )	31.25	50	25	50	ns
2	$t_w(\text{CKIH})$	Pulse duration, CLKIN high	10		8		ns
3	$t_w(\text{CKIL})$	Pulse duration, CLKIN low	10		8		ns
4	$t_t(\text{CKI})$	Transition time, CLKIN	2 $\dagger$	5 $\dagger$	2 $\dagger$	5 $\dagger$	ns
5	$t_h(\text{CKI-RSL})$	Hold time, $\overline{\text{RESET}}$ low after CLKIN high	10 $\ddagger$		10 $\ddagger$		ns
6	$t_{su}(\text{RSH-CKI})$	Setup time, $\overline{\text{RESET}}$ high to CLKIN $\uparrow$	4 $\ddagger$		4 $\ddagger$		ns
7	$t_w(\text{RSL})$	Initial reset during power up	160 $t_Q - 40$ $\S$		160 $t_Q - 40$ $\S$		ns
		Reset during active operation	16 $t_Q - 40$ $\S$		16 $t_Q - 40$ $\S$		
8	$t_{su}(\text{CSL-RSH})$	Setup time of HCS low to $\overline{\text{RESET}}$ high to configure self-bootstrap mode	8 $t_Q + 55$		8 $t_Q + 55$		ns
9	$t_d(\text{CS-RSH})$	Delay from HCS $\uparrow$ to $\overline{\text{RESET}}$ high to configure self-bootstrap mode	4 $t_Q - 50$ $\parallel$		4 $t_Q - 50$ $\parallel$		ns
10	$t_w(\text{CSL})$	Pulse duration, HCS low to configure GSP in self-bootstrap mode	4 $t_Q + 55$		4 $t_Q + 55$		ns

$\dagger$  These values are based on computer simulation and are not tested.

$\ddagger$  These timings are required only to synchronize the TMS34020 to a particular quarter cycle.

$\S$  The initial reset pulse on power up must remain valid until all internal states have been initialized. Resets applied after the TMS34020 has been initialized need to be present only long enough to be recognized by the internal logic; the internal logic will maintain an internal reset until all internal states have been initialized (34 LCLK1 cycles).

$\parallel$  Parameter 9 is the maximum amount by which the  $\overline{\text{RESET}}$  low-to-high transition can be delayed after the start of the HCS low-to-high transition and still assure that the TMS34020 is configured to run in the self-bootstrap mode (HLT bit = 0) following the end of reset.

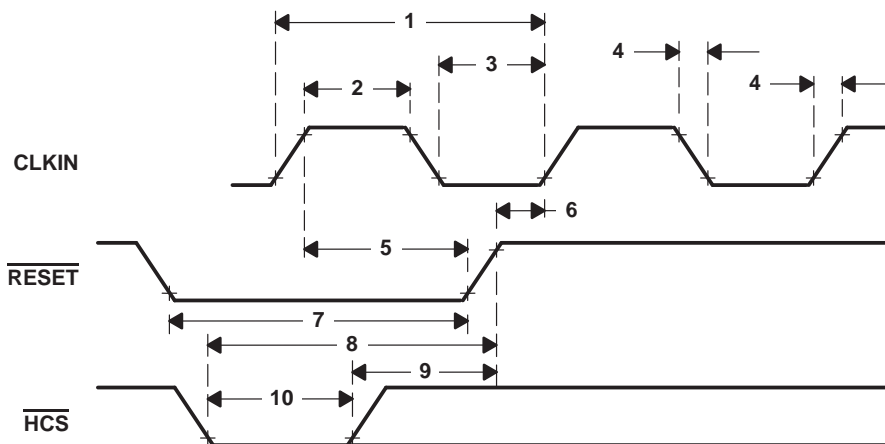

Figure 33. CLKIN and  $\overline{\text{RESET}}$  Timing Requirements

PARAMETER MEASUREMENT INFORMATION

local bus timing: output clocks

NO.	PARAMETER	'34020-32 '34020A-32		'34020A-40		UNIT
		MIN	MAX	MIN	MAX	
11	$t_c(LCK)$ Period of local clocks LCLK1, LCLK2	$4t_c(CKI) + s^\dagger$		$4t_c(CKI) + s^\dagger$		ns
12	$t_w(LCKH)$ Pulse duration, local clock high	$2t_Q - 15$		$2t_Q - 13.5$		ns
12a	$t_w(CK1H)$ Pulse duration, LCLK1 high	$2t_Q - 10^\ddagger$		$2t_Q - 7^\ddagger$		ns
13	$t_w(LCKL)$ Pulse duration, local clock low	$2t_Q - 15 + s$		$2t_Q - 13.5 + s$		ns
13a	$t_w(CK1L)$ Pulse duration, LCLK1 low	$2t_Q - 10 + s^\ddagger$		$2t_Q - 7 + s$		ns
14	$t_t(LCK)$ Transition time, LCLK1 or LCLK2	15		13.5		ns
15	$t_h(CK1H-CK2L)$ Hold time, LCLK2 low after LCLK1 high	$t_Q - 15$		$t_Q - 13.5$		ns
16	$t_h(CK2H-CK1H)$ Hold time, LCLK1 high after LCLK2 high	$t_Q - 15$		$t_Q - 13.5$		ns
17	$t_h(CK1L-CK2H)$ Hold time, LCLK2 high after LCLK1 low	$t_Q - 15$		$t_Q - 13.5$		ns
18	$t_h(CK2L-CK1L)$ Hold time, LCLK1 low after LCLK2 low	$t_Q - 15 + s$		$t_Q - 13.5 + s$		ns
19	$t_h(CK1H-CK2H)$ Hold time, LCLK2 high after LCLK1 high	$3t_Q - 15$		$3t_Q - 13.5$		ns
20	$t_h(CK2H-CK1L)$ Hold time, LCLK1 low after LCLK2 high	$3t_Q - 15 + s$		$3t_Q - 13.5 + s$		ns
21	$t_h(CK1L-CK2L)$ Hold time, LCLK2 low after LCLK1 low	$3t_Q - 15 + s$		$3t_Q - 13.5 + s$		ns
22	$t_h(CK2L-CK1H)$ Hold time, LCLK1 high after LCLK2 low	$3t_Q - 15 + s$		$3t_Q - 13.5 + s$		ns

<sup>†</sup> This is a functional minimum and is not tested. This parameter may also be specified as  $4t_Q$ .

<sup>‡</sup> These parameters are specified with 1.5-V timing levels (parameters 12 and 13 are specified with standard timing voltage levels as detailed on page 54).

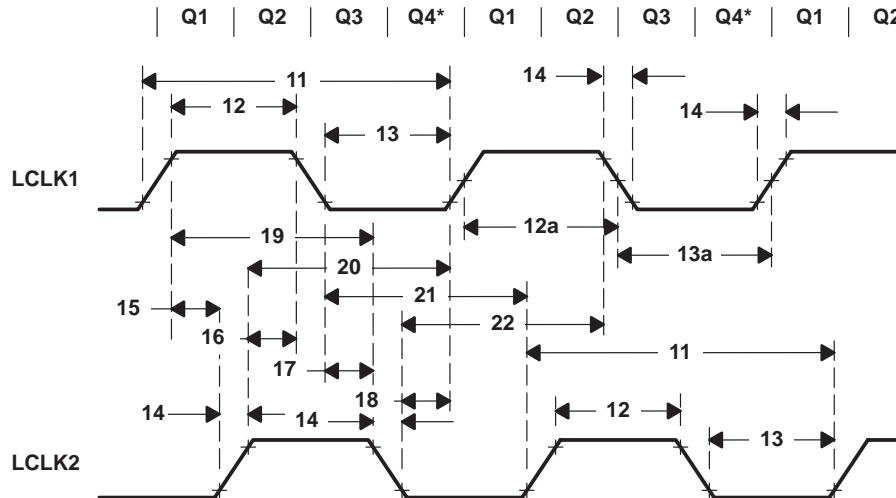

\*See clock stretch, page 21.

NOTE A: Although LCLK1 and LCLK2 are derived from CLKIN, no timing relationship between CLKIN and the local clocks is to be assumed, except the period of the local clocks is four times the period of CLKIN.

Figure 34. Local Bus Timing: Output Clocks

PARAMETER MEASUREMENT INFORMATION

output signal characteristics†

The following general parameters are common to all output signals from the TMS34020 unless otherwise specifically given. In the minimum and maximum values given,  $n$  is an integral number of quarter cycles.

PARAMETER		'34020-32 '34020A-32		'34020A-40		UNIT
		MIN	MAX	MIN	MAX	
$t_h(\text{CKx-SGNV})$	Hold time, LCLKx to output signal not valid	$t_Q - 15$		$t_Q - 13.5$		ns
$t_d(\text{CKx-SGV})$	Delay time, LCLKx start of transition to output signal valid	Fast: $\overline{\text{RAS}}, \overline{\text{CAS}}, \overline{\text{ALTCH}}, \overline{\text{TR/QE}}, \overline{\text{DDOUT}}, \overline{\text{DDIN}}, \text{EMU3}, \overline{\text{HOE}}, \overline{\text{R0}}, \overline{\text{R1}}, \overline{\text{HDST}}, \overline{\text{WE}}$		$t_Q + 15$		ns
		Slow: LAD, RCA, SF		$t_Q + 22$		ns
$t_h(\text{SG1V-SG2NV})^\ddagger$	Hold time, output signal valid to output signal not valid	Fast: $\overline{\text{RAS}}, \overline{\text{CAS}}, \overline{\text{ALTCH}}, \overline{\text{TR/QE}}, \overline{\text{DDOUT}}, \overline{\text{DDIN}}, \text{EMU3}, \overline{\text{HOE}}, \overline{\text{R0}}, \overline{\text{R1}}, \overline{\text{HDST}}, \overline{\text{WE}}$		$nt_Q - 15$		ns
		Slow: LAD, RCA, SF		$nt_Q - 22$		ns
$t_d(\text{SG2NV-SG1V})^\ddagger$	Delay time, output signal started transition to output signal valid	Fast: $\overline{\text{RAS}}, \overline{\text{CAS}}, \overline{\text{ALTCH}}, \overline{\text{TR/QE}}, \overline{\text{DDOUT}}, \overline{\text{DDIN}}, \text{EMU3}, \overline{\text{HOE}}, \overline{\text{R0}}, \overline{\text{R1}}, \overline{\text{HDST}}, \overline{\text{WE}}$		$nt_Q + 15$		ns
		Slow: LAD, RCA, SF		$nt_Q + 22$		ns
$t_t(\text{SG})$	Output signal transition time	Fast: $\overline{\text{RAS}}, \overline{\text{CAS}}, \overline{\text{ALTCH}}, \overline{\text{TR/QE}}, \overline{\text{DDOUT}}, \overline{\text{DDIN}}, \text{EMU3}, \overline{\text{HOE}}, \overline{\text{R0}}, \overline{\text{R1}}, \overline{\text{HDST}}, \overline{\text{WE}}$		15		ns
		Slow: LAD, RCA, SF		22		ns
$t_w(\text{SGH})$	Pulse duration, output signal high	Fast: $\overline{\text{RAS}}, \overline{\text{CAS}}, \overline{\text{ALTCH}}, \overline{\text{TR/QE}}, \overline{\text{DDOUT}}, \overline{\text{DDIN}}, \text{EMU3}, \overline{\text{HOE}}, \overline{\text{R0}}, \overline{\text{R1}}, \overline{\text{HDST}}, \overline{\text{WE}}$		$nt_Q - 15$		ns
		Slow: LAD, RCA, SF		$nt_Q - 22$		ns
$t_w(\text{SGL})$	Pulse duration, output signal low	Fast: $\overline{\text{RAS}}, \overline{\text{CAS}}, \overline{\text{ALTCH}}, \overline{\text{TR/QE}}, \overline{\text{DDOUT}}, \overline{\text{DDIN}}, \text{EMU3}, \overline{\text{HOE}}, \overline{\text{R0}}, \overline{\text{R1}}, \overline{\text{HDST}}, \overline{\text{WE}}$		$nt_Q - 15$		ns
		Slow: LAD, RCA, SF		$nt_Q - 22$		ns

† Also refer to Figure 35 on following page.

‡ For parameters on this page specifying minimum or maximum times between two output signals, the word "fast" or "slow" in column 2 refers to the signal with a subscript of 1, regardless of the other signal. For example, if you are using the spec " $t_h(\text{SG2NV-SG1V})$ ", use the slow value if the signal becoming valid ( $\text{SG}_1$ ) is RCA, LAD, or SF; use the fast value otherwise. The pin referred to as  $\text{SG}_2$  does not determine fast or slow signal time.

PARAMETER MEASUREMENT INFORMATION

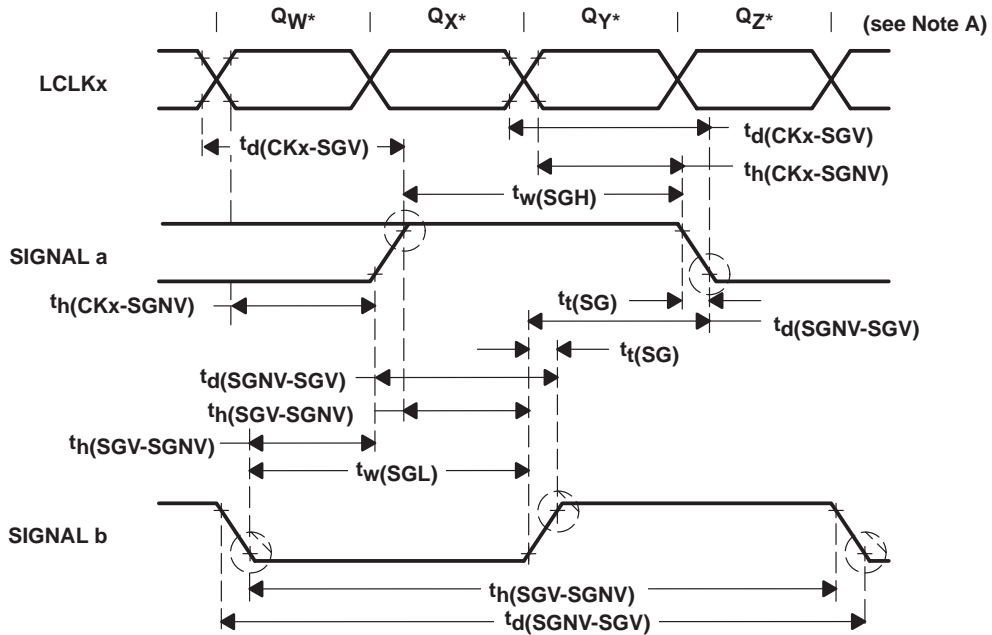

\*See clock stretch, page 21.

○ indicates the point at which the signal has attained a valid level.

NOTE A: Any of these quarter phases could be  $2t_Q$  if they are stretched. See clock stretch, page 21.

Figure 35. Output Signal Characteristics

All timing parameters relative to the circled points on the diagram have a fast and a slow value. Determine which value to use for any parameter by the name of the signal that has the circle on it.

example of how to use the general output signal characteristics

Assume a system is using a TMS34020-32. Determine the maximum time from the start of the falling edge of  $\overline{ALTCH}$  to the time when data must be valid on the LAD bus for a local memory write cycle.

From the local memory write cycle diagram on page 27, the time from the falling edge of  $\overline{ALTCH}$  to valid data on the LAD bus is roughly  $Q3 + Q4$ ; i.e.,  $2t_Q$ . A more precise value can be obtained by using the table of output signal characteristics.

The parameter of interest is  $t_d(SGNV-SGV)$ . Note that in the diagram above, there are two representations of  $t_d(SGNV-SGV)$  that relate SIGNALa and SIGNALb (the third representation of this parameter relates SIGNALb to itself and is not useful in this example). Let SIGNALa represent  $\overline{ALTCH}$  because  $\overline{ALTCH}$  is making a transition first. Let SIGNALb represent the LAD bus. By definition, the signal becoming valid (SGV) determines whether the fast value or the slow value from the table is used. On the diagram, the SGV points are marked with a circle.

In this case, for parameter  $t_d(SGNV-SGV)$ , SGV is the LAD bus. LAD is in the slow group, so the maximum value for  $t_d(SGNV-SGV)$  is  $nt_Q + 22$ . The value for  $n$  is 2 from the analysis of the diagram on page 27. Thus, the maximum time from the start of the falling edge of  $\overline{ALTCH}$  to the time when data must be valid on the LAD bus for a local memory write cycle is  $2t_Q + 22$  ns.

PARAMETER MEASUREMENT INFORMATION

host interface timing requirements (see Figure 36 and Note 3)

NO.	PARAMETER	'34020-32 '34020A-32		'34020A-40		UNIT
		MIN	MAX	MIN	MAX	
23	$t_{su}(AV-CS\downarrow)$ Setup time of address prior to $\overline{HCS}\downarrow$	12		10		ns
24	$t_h(CSL-AV)$ Hold time of address after $\overline{HCS}$ low	12		10		ns
25	$t_w(CSH)$ Pulse duration of $\overline{HCS}$ high	28		25		ns
26	$t_w(RDH)$ Pulse duration of $\overline{HREAD}$ high	28		25		ns
27	$t_w(WRH)$ Pulse duration of $\overline{HWRITE}$ high	28		25		ns
28	$t_{su}(RDH-WR\downarrow)$ Setup time, $\overline{HREAD}$ high to $\overline{HWRITE}\downarrow$	28		25		ns
29	$t_{su}(WRH-RD\downarrow)$ Setup time, $\overline{HWRITE}$ high to $\overline{HREAD}\downarrow$	28		25		ns
30	$t_w(RDL)$ Pulse duration of $\overline{HREAD}$ low	18		15		ns
31	$t_w(WRL)$ Pulse duration of $\overline{HWRITE}$ low	18		15		ns
32	$t_{su}(CSL-WR\uparrow)$ Setup time, $\overline{HCS}$ low to $\overline{HWRITE}\uparrow$	18		15		ns
33	$t_{su}(RDL-CK2\downarrow)$ Setup time, later of $\overline{HCS}$ low or $\overline{HREAD}$ low to $LCLK2\downarrow$	30 <sup>†</sup>		25 <sup>†</sup>		ns
34	$t_{su}(WRH-CK2\downarrow)$ Setup time, later of $\overline{HWRITE}$ high or $\overline{HCS}$ high to $LCLK2\downarrow$	30 <sup>†</sup>		25 <sup>†</sup>		ns
35	$t_h(CK2\downarrow-RDH)$ Hold time, $\overline{HREAD}$ high after $LCLK2\downarrow$	0 <sup>‡</sup>		0 <sup>‡</sup>		ns
36	$t_h(CK2\downarrow-WRL)$ Hold time, $\overline{HWRITE}$ low after $LCLK2\downarrow$	0 <sup>‡</sup>		0 <sup>‡</sup>		ns
37	$t_{su}(RDH-CK2\downarrow)$ Setup time, $\overline{HREAD}$ high to $LCLK2\downarrow$ , prefetch read mode	30 <sup>†§</sup>		25 <sup>†§</sup>		ns
38	$t_{su}(CSL-RD\uparrow)$ Setup time, $\overline{HCS}$ low to $\overline{HREAD}\uparrow$	18		15		ns

<sup>†</sup> Setup time to insure recognition of input on this clock edge.

<sup>‡</sup> Hold time required to assure response on next clock edge. These values are based on computer simulation and are not tested.

<sup>§</sup> When the TMS34020 is set for block reads, use the deassertion of  $\overline{HREAD}$  to request a local memory cycle at the next sequential address location.

NOTE 3: Although  $\overline{HCS}$ ,  $\overline{HREAD}$ , and  $\overline{HWRITE}$  can be totally asynchronous to the TMS34020, cycle responses to the signals are determined by local memory cycles.

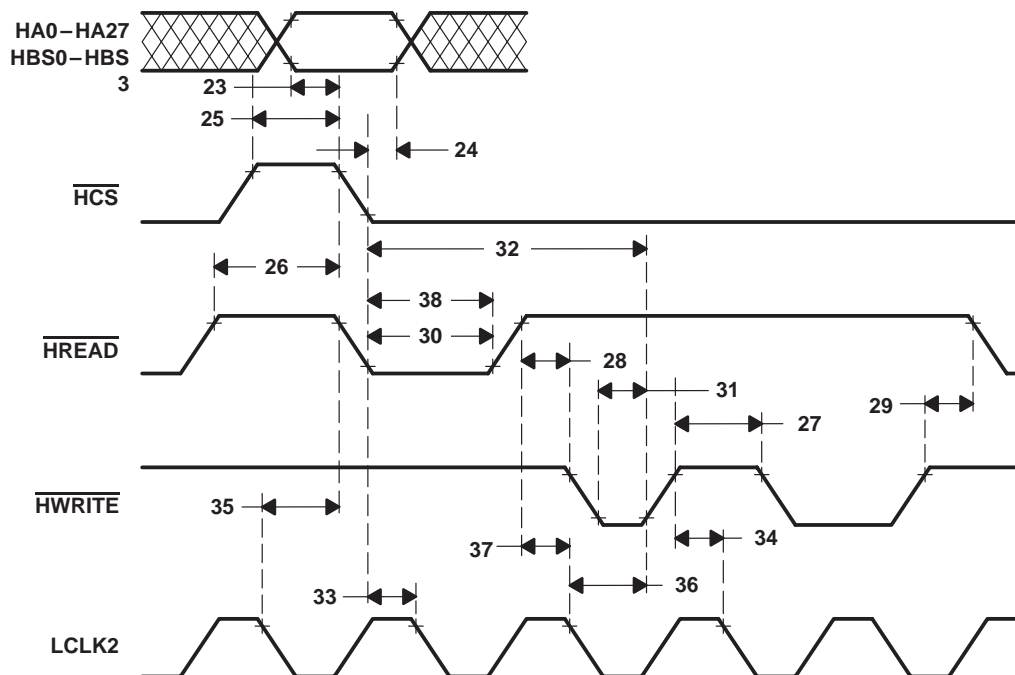

Figure 36. Host Interface Timing Requirements

PARAMETER MEASUREMENT INFORMATION

host interface timing responses (random read cycle) (see Figure 37)

NO.	PARAMETER	'34020-32 '34020A-32		'34020A-40		UNIT
		MIN	MAX	MIN	MAX	
33	$t_{su}(RDL-CK2\downarrow)$ Setup time, later of $\overline{HCS}$ low or $\overline{HREAD}$ low to LCLK2 $\downarrow$	30†		25†		ns
39	$t_d(CK1\uparrow-RYH)$ Delay time from LCLK1 $\uparrow$ to HRDY high (end of read cycle)		$t_Q + 20$		$t_Q + 18$	ns
40	$t_d(RDH-RYL)$ Delay time from earlier of $\overline{HREAD}$ or $\overline{HCS}$ high to HRDY low		20		18	ns
41	$t_d(CK2\downarrow-STL)$ Delay time from LCLK2 $\downarrow$ to HDST low		$t_Q + 15 + s$		$t_Q + 13.5 + s$	ns
42	$t_d(CK1\downarrow-STH)$ Delay time from LCLK1 $\downarrow$ to HDST high		$t_Q + 15$		$t_Q + 13.5$	ns
43	$t_{su}(STL-RY\uparrow)$ Setup time of HDST low to HRDY $\uparrow$	$t_Q - 15$		$t_Q - 13.5$		ns
44	$t_d(RY\uparrow-STH)$ Delay time from HRDY $\uparrow$ to HDST high		$2t_Q + 15$		$2t_Q + 13.5$	ns
50	$t_h(STH-CTV)$ Hold time, $\overline{CAS}$ , $\overline{TR}/\overline{QE}$ , DDIN valid after HDST high	0		-2		ns

† Setup time to insure recognition of input on this clock edge.

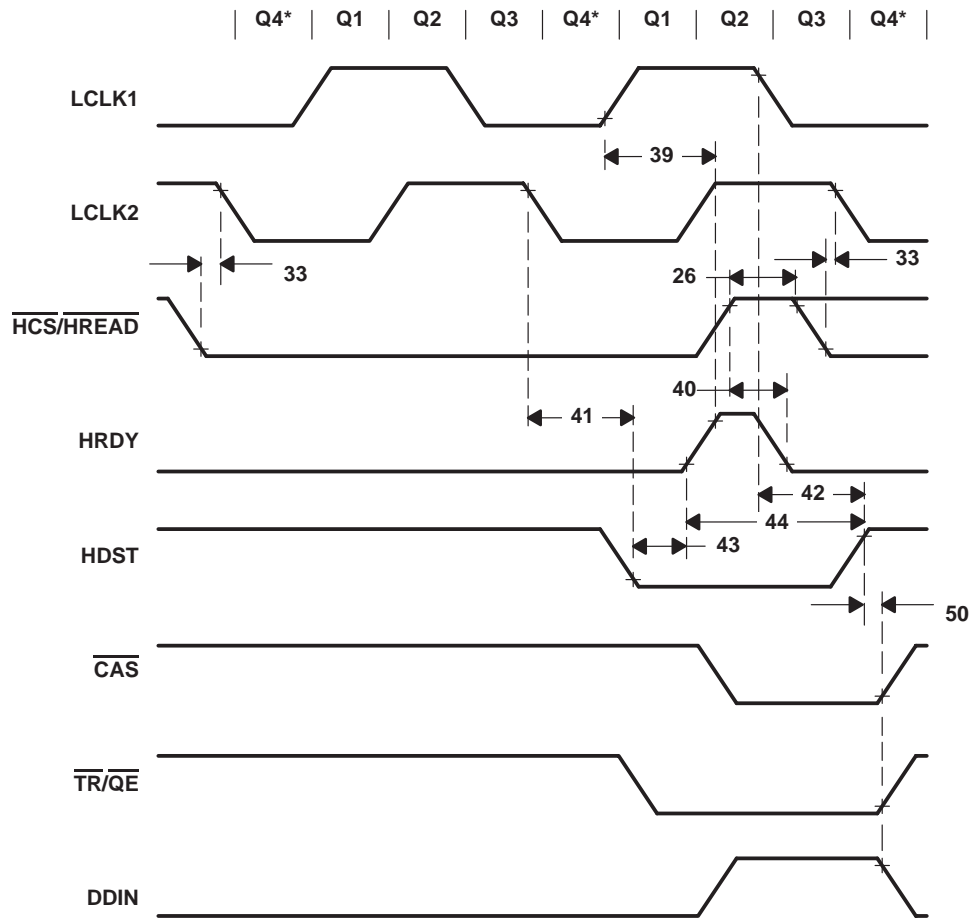

\*See clock stretch, page 21.

Figure 37. Host Interface Timing Responses (Random Read Cycle)

PARAMETER MEASUREMENT INFORMATION

host interface timing (block read cycle) (see Figure 38 and Note 3)

NO.	PARAMETER	'34020-32 '34020A-32		'34020A-40		UNIT
		MIN	MAX	MIN	MAX	
37	$t_{su}(\overline{RDH}-CK2\downarrow)$ Setup time, $\overline{HREAD}$ high to LCLK2 $\downarrow$ , prefetch read mode	30†		25†		ns
39	$t_d(CK1\uparrow-RYH)$ Delay time from LCLK1 $\uparrow$ to HRDY high		$t_Q+20$		$t_Q+18$	ns
40	$t_d(\overline{RDH}-RYL)$ Delay time from earlier of $\overline{HREAD}$ or $\overline{HCS}$ high to HRDY low		20		18	ns
41	$t_d(CK2\downarrow-STL)$ Delay time from LCLK2 $\downarrow$ to HDST low		$t_Q+15+s$		$t_Q+13.5+s$	ns
42	$t_d(CK1\downarrow-STH)$ Delay time from LCLK1 $\downarrow$ to HDST high		$t_Q+15$		$t_Q+13.5$	ns
43	$t_{su}(STL-RY\uparrow)$ Setup time of HDST low to HRDY $\uparrow$	$t_Q-15$		$t_Q-13.5$		ns
44	$t_d(RY\uparrow-STH)$ Delay time from HRDY $\uparrow$ to HDST high		$2t_Q+15$		$2t_Q+13.5$	ns
45	$t_d(\overline{RDH}-RYH)$ Delay time from later of $\overline{HREAD}$ or $\overline{HCS}$ low to HRDY high after prefetch		25		20	ns

† Setup time to insure recognition of input on this clock edge. When the TMS34020 is set for block reads, the deassertion of  $\overline{HREAD}$  is used to request a local memory cycle at the next sequential address location.

NOTE 3. Although  $\overline{HCS}$ ,  $\overline{HREAD}$ , and  $\overline{HWRITE}$  can be totally asynchronous to the TMS34020, cycle responses to the signals are determined by local memory cycles.

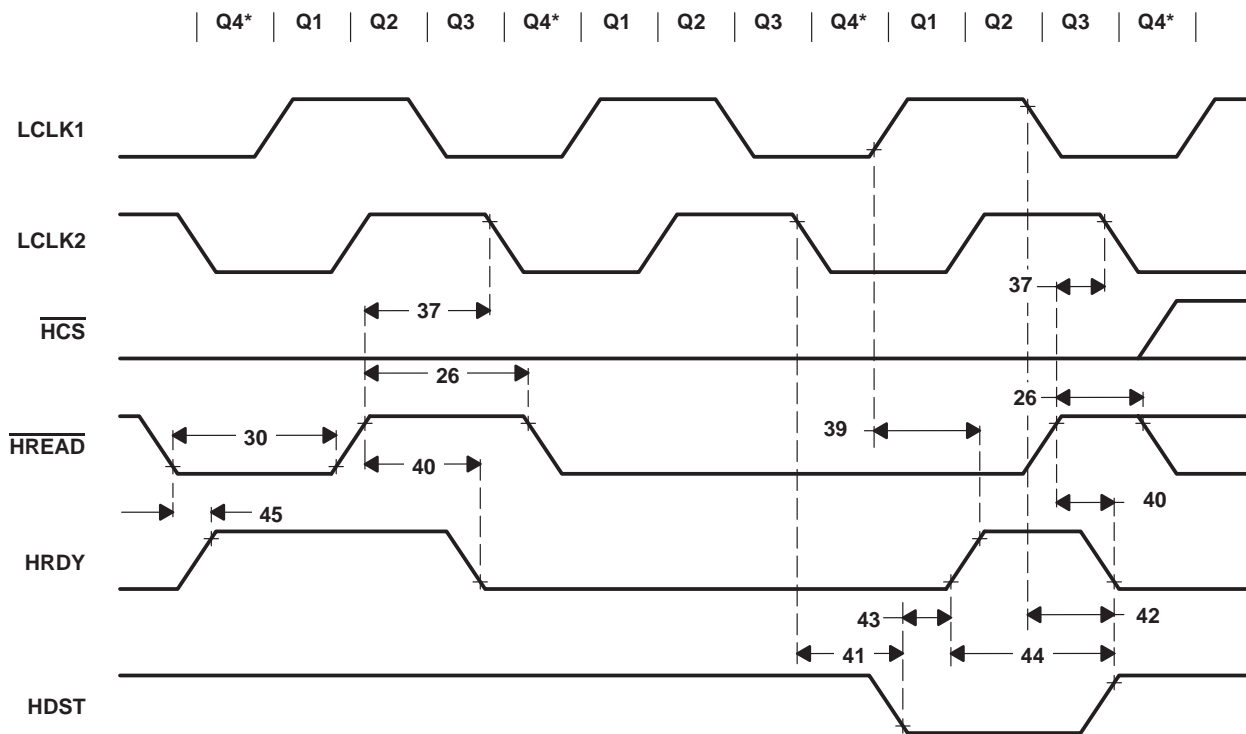

\*See clock stretch, page 21.

Figure 38. Host Interface Timing (Block Read Cycle)

PARAMETER MEASUREMENT INFORMATION

host interface timing responses (write cycle) (see Figure 39)

NO.	PARAMETER	'34020-32 '34020A-32		'34020A-40		UNIT
		MIN	MAX	MIN	MAX	
46	$t_d(\text{WRL-RYH})$ Delay time from later of $\overline{\text{HCS}}$ or $\overline{\text{HWRITE}}$ low to HRDY high (TMS34020 ready)		25		20	ns
47	$t_d(\text{WRH-RYL})$ Delay time from earlier of $\overline{\text{HCS}}$ or $\overline{\text{HWRITE}}$ high to HRDY low (end of write)		25		20	ns
48	$t_d(\text{CK2}\downarrow\text{-OEL})$ Delay time from LCLK2 $\downarrow$ to $\overline{\text{HOE}}$ low		$t_Q + 15 + s$		$t_Q + 13.5 + s$	ns
49	$t_d(\text{CK1}\downarrow\text{-OEH})$ Delay time from LCLK1 $\downarrow$ to $\overline{\text{HOE}}$ high		$t_Q + 15$		$t_Q + 13.5$	ns
39	$t_d(\text{CK1}\uparrow\text{-RYH})$ Delay time from LCLK1 $\uparrow$ to HRDY high		$t_Q + 20$		$t_Q + 18$	ns
b	$t_h(\text{CEH-OEL})$ Hold time, $\overline{\text{CAS}}$ valid high after $\overline{\text{HOE}}$ valid low	$t_Q - 10$		$t_Q - 7$		
51	$t_d(\text{RY}\uparrow\text{-OEH})$ Delay time from HRDY $\uparrow$ to $\overline{\text{HOE}}$ high		$2t_Q + 15$		$2t_Q + 13.5$	ns

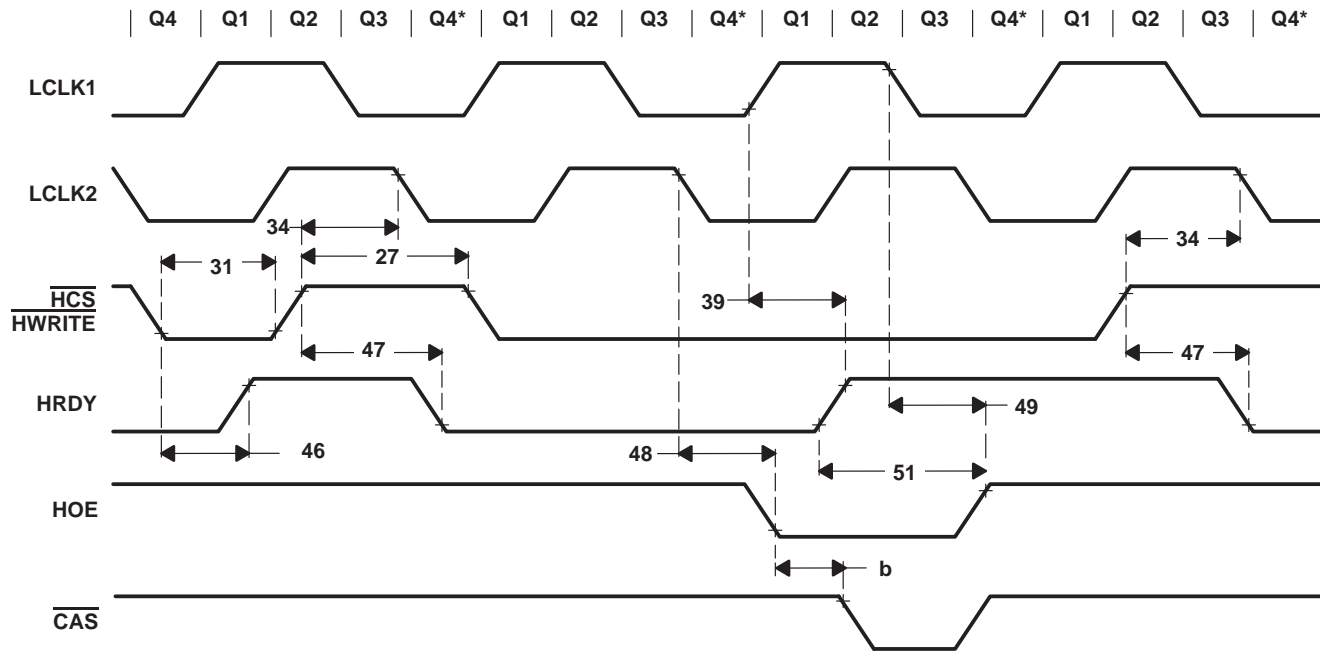

\*See clock stretch, page 21.

Figure 39. Host Interface Timing Responses (Write Cycle)



PARAMETER MEASUREMENT INFORMATION

local bus timing: bus control inputs (see Figure 40)

NO.	PARAMETER	'34020-32 '34020A-32		'34020A-40		UNIT
		MIN	MAX	MIN	MAX	
52	$t_{a(CMV-LAV)}^{\dagger}$ Access time, $\overline{CAMD}$ valid after address valid on LAD		$3t_Q - 45$		$3t_Q - 37$	ns
53	$t_{h(LANV-CMV)}^{\dagger}$ Hold time, $\overline{CAMD}$ valid after address no longer valid on LAD	0		0		ns
54	$t_{a(BCV-ALL)}^{\dagger}$ Access time, control valid ( $\overline{LRDY}$ , $\overline{PGMD}$ , $\overline{SIZE16}$ , $\overline{BUSFLT}$ ) after $\overline{ALTCH}$ low		$3t_Q - 35 + s$		$3t_Q - 27 + s$	ns
55	$t_{h(CK2H-BCV)}^{\dagger}$ Hold time, control ( $\overline{LRDY}$ , $\overline{PGMD}$ , $\overline{SIZE16}$ , $\overline{BUSFLT}$ ) valid after LCLK2 high	0		0		ns
56	$t_{su(BCV-CK2)}^{\dagger}$ Setup time, $\overline{SIZE16}$ , $\overline{LRDY}$ , $\overline{PGMD}$ , $\overline{BUSFLT}$ valid before LCLK2 $\uparrow$	20		15		ns

$\dagger$   $\overline{CAMD}$ ,  $\overline{LRDY}$ ,  $\overline{PGMD}$ ,  $\overline{SIZE16}$ , and  $\overline{BUSFLT}$  are synchronous inputs. The specified setup, access, and hold times must be met for proper device operation.

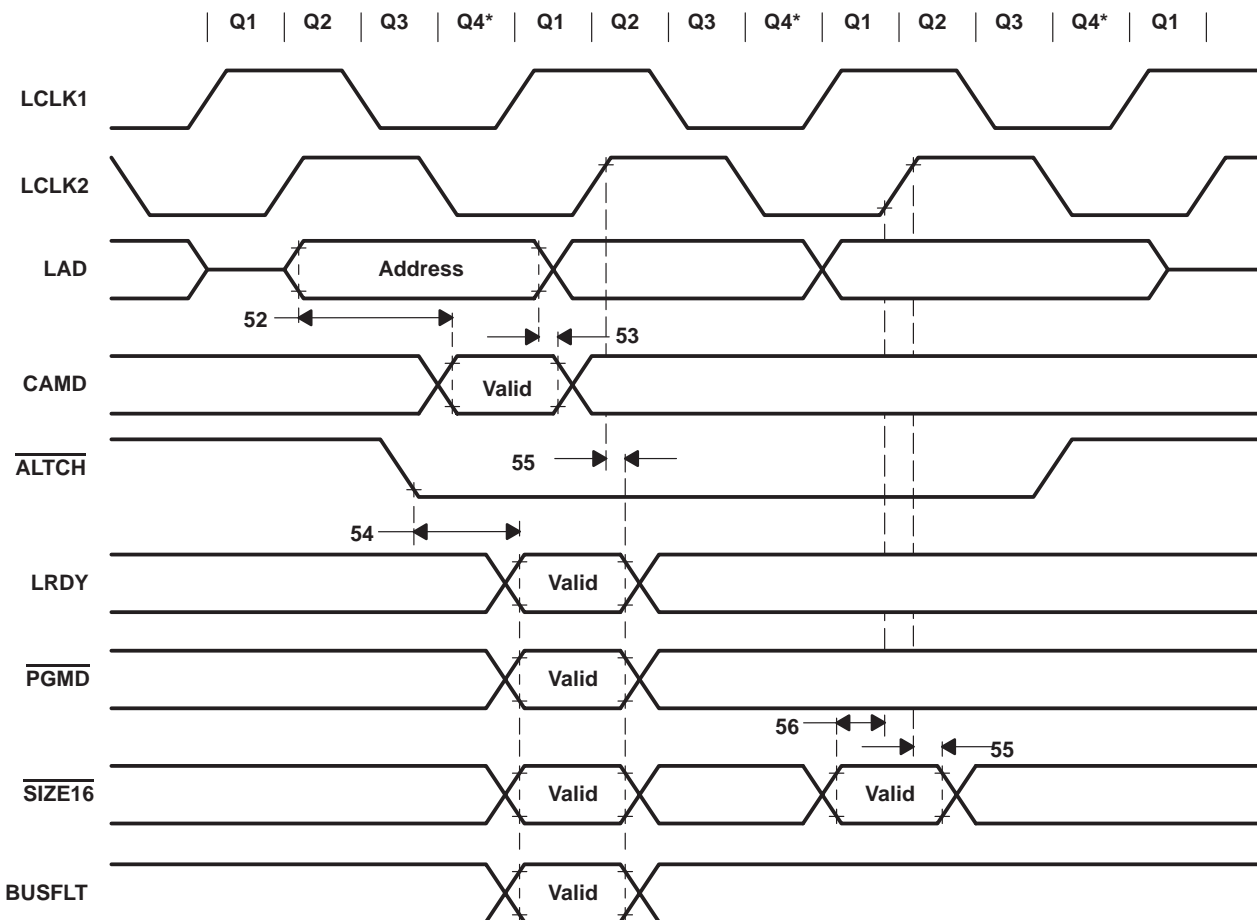

\*See clock stretch, page 21.

Figure 40. Local Bus Timing: Bus Control Inputs

# TMS34020, TMS34020A GRAPHICS PROCESSORS

SPVS004D – MARCH 1990 – REVISED NOVEMBER 1993

## PARAMETER MEASUREMENT INFORMATION

### local bus timing: bus control inputs (see Figure 41)

NO.	PARAMETER	'34020-32 '34020A-32		'34020A-40		UNIT
		MIN	MAX	MIN	MAX	
57	$t_d(\text{CK2}\uparrow\text{-ALL})$ Delay time, $\overline{\text{ALTCH}}$ low after LCLK2 $\uparrow$		$t_Q + 15$		$t_Q + 13.5$	ns
58	$t_d(\text{CK1}\downarrow\text{-ALH})$ Delay time, $\overline{\text{ALTCH}}$ high after LCLK1 $\downarrow$		$t_Q + 15$		$t_Q + 13.5$	ns
59	$t_d(\text{CK1}\uparrow\text{-LAV})$ Delay time, LAD0–LAD31 address valid after LCLK1 $\uparrow$		$t_Q + 22$		$t_Q + 20$	ns
60	$t_h(\text{LAV-CK2L})$ Hold time, LAD0–LAD31 address valid after LCLK2 low	$t_Q - 15 + s$		$t_Q - 12 + s$		ns
61	$t_d(\text{CTNV-LAD})$ Delay time, LAD0–LAD31 driven earlier after earlier of DDIN $\downarrow$ or CAS $\uparrow$ or $\overline{\text{TR/QE}}\uparrow$	$t_Q - 5 + s \dagger$		$t_Q - 5 + s \dagger$		ns
62	$t_h(\text{LAV-CTV})$ Hold time, LAD0–LAD31 read data valid after earlier of DDIN low or $\overline{\text{RAS}}$ , CAS, or $\overline{\text{TR/QE}}$ high	0		2		ns
63	$t_d(\text{CK2}\downarrow\text{-LAV})$ Delay time, LAD0–LAD31 data valid after LCLK2 $\downarrow$ (write)		$t_Q + 22 + s$		$t_Q + 20 + s$	ns
64	$t_h(\text{CK2L-LAV})$ Hold time, LAD0–LAD31 data valid after LCLK2 low (write)	$t_Q - 15$		$t_Q - 13.5$		ns
65	$t_d(\text{CK1}\uparrow\text{-RCV})$ Delay time, RCA0–RCA12 row address valid after LCLK1 $\uparrow$		$t_Q + 22$		$t_Q + 20$	ns
66	$t_d(\text{CK2}\downarrow\text{-RCV})$ Delay time, RCA0–RCA12 column address valid after LCLK2 $\downarrow$		$t_Q + 22 + s$		$t_Q + 20 + s$	ns
67	$t_h(\text{RCV-CK2L})$ Hold time, RCA0–RCA12 address valid after LCLK2 low	$t_Q - 15$		$t_Q - 12$		ns
68	$t_d(\text{CK1}\uparrow\text{-DIH})$ Delay time, DDIN high after LCLK1 $\uparrow$		$t_Q + 15$		$t_Q + 13.5$	ns
69	$t_d(\text{CK1}\downarrow\text{-DIL})$ Delay time, DDIN low after LCLK1 $\downarrow$		$t_Q + 15$		$t_Q + 13.5$	ns
70	$t_d(\text{CK1}\uparrow\text{-DOL})$ Delay time, $\overline{\text{DDOUT}}$ low after LCLK1 $\uparrow$		$t_Q + 15$		$t_Q + 13.5$	ns
71	$t_d(\text{CK1}\downarrow\text{-DOH})$ Delay time, $\overline{\text{DDOUT}}$ high after LCLK1 $\downarrow$		$t_Q + 15$		$t_Q + 13.5$	ns
72	$t_d(\text{CK2}\downarrow\text{-DOL})$ Delay time, $\overline{\text{DDOUT}}$ low after LCLK2 $\downarrow$		$t_Q + 15 + s$		$t_Q + 13.5 + s$	ns
73	$t_{su}(\text{LAV-AL}\downarrow)$ Setup time, LAD0–LAD31 data valid before $\overline{\text{ALTCH}}\downarrow$	$t_Q - 16$		$t_Q - 13$		ns
74	$t_{en}(\text{DAV-DIH})$ Enable time, data valid after DDIN high (see Note 4)		$2t_Q - 20$		$2t_Q - 17$	ns
75	$t_{dis}(\text{DAV-DIL})$ Disable time, data high-impedance after DDIN low (see Note 4)		$t_Q - 12 + s$		$t_Q - 10 + s$	ns
e	$t_h(\text{REL-RCV})$ Hold time, $\overline{\text{RAS}}$ valid low after column address valid	$3t_Q - 22$		$3t_Q - 12$		ns
f	$t_h(\text{CEL-RCV})$ Hold time, $\overline{\text{CAS}}$ valid low after column address valid	$3t_Q - 22$		$3t_Q - 12$		ns
g	$t_h(\text{WEH-RCV})$ Hold time, $\overline{\text{WE}}$ valid low after column address valid	$4t_Q - 22 + s$		$4t_Q - 18 + s$		ns
h	$t_h(\text{LAV-WEH})$ Hold time, LAD data valid after $\overline{\text{WE}}$ valid high	$t_Q - 15$		$t_Q - 12$		ns

$\dagger$  These values are derived from characterization data and are not tested.

NOTE 4: DDIN is used to control LAD bus buffers between the TMS34020 and local memory. Parameter 74 references the time for these data buffers to go from the high-impedance state to an active level. Parameter 75 references the time for the buffers to go from an active level to the high-impedance state.

PARAMETER MEASUREMENT INFORMATION

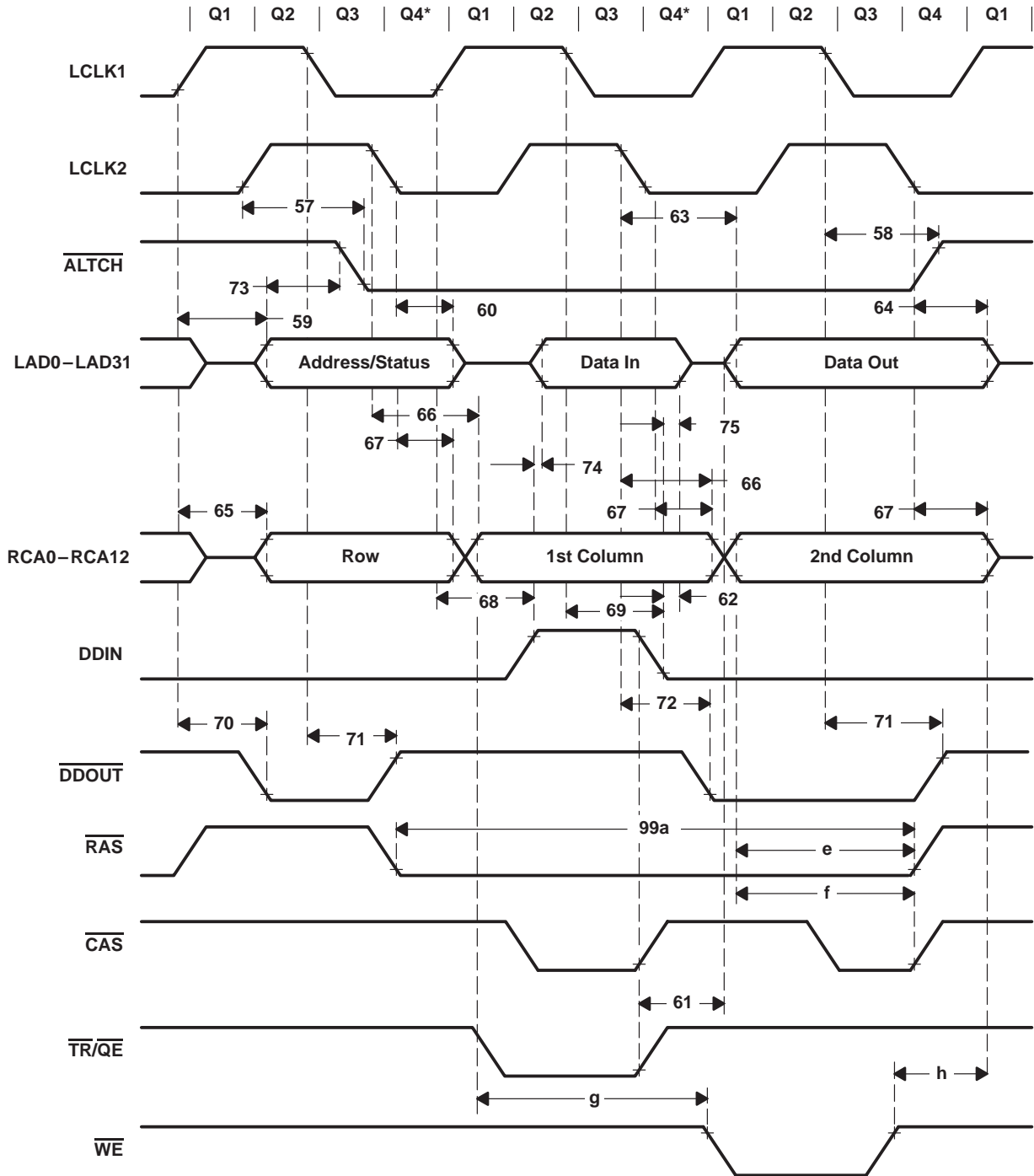

\*See clock stretch, page 21.

Figure 41. Local Bus Timing: Bus Control Inputs

# TMS34020, TMS34020A GRAPHICS PROCESSORS

SPVS004D – MARCH 1990 – REVISED NOVEMBER 1993

## PARAMETER MEASUREMENT INFORMATION

local bus timing:  $\overline{\text{RAS}}$ ,  $\overline{\text{CAS0}}\text{--}\overline{\text{CAS3}}$ ,  $\overline{\text{WE}}$ ,  $\overline{\text{TR/QE}}$ , and SF

NO.	PARAMETER	'34020-32 '34020A-32		'34020A-40		UNIT
		MIN	MAX	MIN	MAX	
62	$t_h(\text{LAV-CTV})$ Hold time, LAD0–LAD31 read data valid after earlier of DDIN, LCLK2 low or $\overline{\text{RAS}}$ , $\overline{\text{CAS}}$ , or $\overline{\text{TR/QE}}$ high	0		2		ns
76	$t_d(\text{CK1}\downarrow\text{-REL})$ Delay time, $\overline{\text{RAS}}$ low after LCLK1 $\downarrow$		$t_Q + 12 + s$		$t_Q + 10 + s$	ns
77	$t_d(\text{CK1}\downarrow\text{-REH})$ Delay time, $\overline{\text{RAS}}$ high after LCLK1 $\downarrow$		$t_Q + 12$		$t_Q + 10$	ns
78	$t_d(\text{CK1}\uparrow\text{-CEL})$ Delay time, $\overline{\text{CAS}}$ low after LCLK1 $\uparrow$		$t_Q + 12$		$t_Q + 10$	ns
79	$t_d(\text{CK1}\downarrow\text{-CEH})$ Delay time, $\overline{\text{CAS}}$ high after LCLK1 $\downarrow$		$t_Q + 12$		$t_Q + 10$	ns
80	$t_d(\text{CK2}\downarrow\text{-WEL})$ Delay time, $\overline{\text{WE}}$ low after LCLK2 $\downarrow$		$t_Q + 15 + s$		$t_Q + 13.5 + s$	ns
81	$t_d(\text{CK1}\downarrow\text{-WEH})$ Delay time, $\overline{\text{WE}}$ high after LCLK1 $\downarrow$		$t_Q + 15$		$t_Q + 15$	ns
82	$t_d(\text{CK2}\downarrow\text{-TRL})$ Delay time, $\overline{\text{TR/QE}}$ low after LCLK2 $\downarrow$		$t_Q + 15 + s$		$t_Q + 13.5 + s$	ns
83	$t_d(\text{CK1}\downarrow\text{-TRH})$ Delay time, $\overline{\text{TR/QE}}$ high after LCLK1 $\downarrow$		$t_Q + 15$		$t_Q + 13.5$	ns
84	$t_d(\text{CK1}\uparrow\text{-SFV})$ Delay time, SF valid after LCLK1 $\uparrow$		$t_Q + 22$		$t_Q + 20$	ns
85	$t_d(\text{CK2}\downarrow\text{-SFV})$ Delay time, SF valid after LCLK2 $\downarrow$		$t_Q + 22 + s$		$t_Q + 20 + s$	ns
86	$t_d(\text{CK2}\downarrow\text{-SFZ})$ Delay time, SF high-impedance after LCLK2 $\downarrow$		$t_Q + 22 \dagger$		$t_Q + 20 \dagger$	ns
87	$t_{su}(\text{ADV-RE}\downarrow)\ddagger$ Setup time, row address valid before $\overline{\text{RAS}}\downarrow$	$2t_Q - 22$		$2t_Q - 20$		ns
88	$t_h(\text{ADV-REL})\ddagger$ Hold time, row address valid after $\overline{\text{RAS}}$ low	$t_Q - 5 + s$		$t_Q - 5 + s$		ns
89	$t_{su}(\text{RCV-CE}\downarrow)$ Setup time, column address valid before $\overline{\text{CAS}}\downarrow$	$t_Q - 22$		$t_Q - 20$		ns
90	$t_h(\text{RCV-CEH})$ Hold time, column address valid after $\overline{\text{CAS}}$ high	$t_Q - 15$		$t_Q - 13.5$		ns
91	$t_{su}(\text{CAV-CE}\downarrow)$ Setup time, write data valid before $\overline{\text{CAS}}\downarrow$	$t_Q - 22$		$t_Q - 20$		ns
92	$t_h(\text{CAV-CE}\uparrow)$ Hold time, write data valid after $\overline{\text{CAS}}\uparrow$	$t_Q - 15$		$t_Q - 13.5$		ns
93	$t_a(\text{LAV-REL})$ Access time, data in valid after $\overline{\text{RAS}}$ low (assuming maximum transition time)		$4t_Q - 8 + s$		$4t_Q - 8 + s$	ns
94	$t_a(\text{LAV-CEL})$ Access time, data in valid after $\overline{\text{CAS}}\downarrow$		$2t_Q - 8$		$2t_Q - 8$	ns
95	$t_a(\text{LAV-RCV})$ Access time, data in valid after column address valid		$3t_Q - 17$		$3t_Q - 2$	ns
96	$t_a(\text{LAV-LAV})$ Access time, data in valid after address valid on LAD bus		$6t_Q - 17 + s$		$6t_Q - 17 + s$	ns
97	$t_{su}(\text{WEL-CE}\downarrow)$ Setup time, write low before $\overline{\text{CAS}}\downarrow$ (on write cycles)	$t_Q - 15$		$t_Q - 13.5$		ns
98	$t_w(\text{REH})$ Pulse duration of $\overline{\text{RAS}}$ high	$4t_Q - 12 + s$		$4t_Q - 10 + s$		ns
99a	$t_w(\text{REL})$ Pulse duration of $\overline{\text{RAS}}$ low	$4nt_Q - 12 + s' \S \parallel$		$4nt_Q - 4 + s' \S \parallel$		ns

$\dagger$  These values are derived from characterization data and are not tested.

$\ddagger$  Parameters 87 and 88 also apply to  $\overline{\text{WE}}$ ,  $\overline{\text{TR/QE}}$ , and SF relative to  $\overline{\text{RAS}}$ .

$\S$   $s'$  is  $2t_Q$  since both the address cycle and the read data cycle of a read-modify-write will be stretched. See clock stretch, page 21.

$\parallel$   $n$  = number of GSP data cycles in in the memory access.



PARAMETER MEASUREMENT INFORMATION

local bus timing:  $\overline{\text{RAS}}$ ,  $\overline{\text{CAS0}}-\overline{\text{CAS3}}$ ,  $\overline{\text{WE}}$ ,  $\overline{\text{TR/QE}}$ , and SF

NO.	PARAMETER		'34020-32 '34020A-32		'34020A-40		UNIT
			MIN	MAX	MIN	MAX	
99b	$t_{w(\text{REL})}$	Pulse duration of $\overline{\text{RAS}}$ low	$4nt_{\text{Q}} - 12 + s \uparrow$		$4nt_{\text{Q}} - 4 + s \uparrow$		ns
100	$t_{w(\text{CEH})}$	Pulse duration of $\overline{\text{CAS}}$ high	$2t_{\text{Q}} - 12$		$2t_{\text{Q}} - 10$		ns
101	$t_{w(\text{CEL})}$	Pulse duration of $\overline{\text{CAS}}$ low	$2t_{\text{Q}} - 8$		$2t_{\text{Q}} - 8$		ns
102	$t_{\text{d}(\text{REL-CE}\uparrow)}$	Delay time $\overline{\text{RAS}}$ low to $\overline{\text{CAS}}\uparrow$	$4t_{\text{Q}} - 12 + s$		$4t_{\text{Q}} - 4 + s$		ns
e	$t_{\text{h}(\text{REL-RCV})}$	Hold time, $\overline{\text{RAS}}$ valid low after column address valid	$3t_{\text{Q}} - 22$		$3t_{\text{Q}} - 12$		ns
f	$t_{\text{h}(\text{CEL-RCV})}$	Hold time, $\overline{\text{CAS}}$ valid low after column address valid	$3t_{\text{Q}} - 22$		$3t_{\text{Q}} - 12$		ns
h	$t_{\text{h}(\text{LAV1-WEH})}$	Hold time, LAD data valid after $\overline{\text{WE}}$ valid high	$t_{\text{Q}} - 15$		$t_{\text{Q}} - 12$		ns

$\uparrow n =$  number of GSP data cycles in in the memory access.

PARAMETER MEASUREMENT INFORMATION

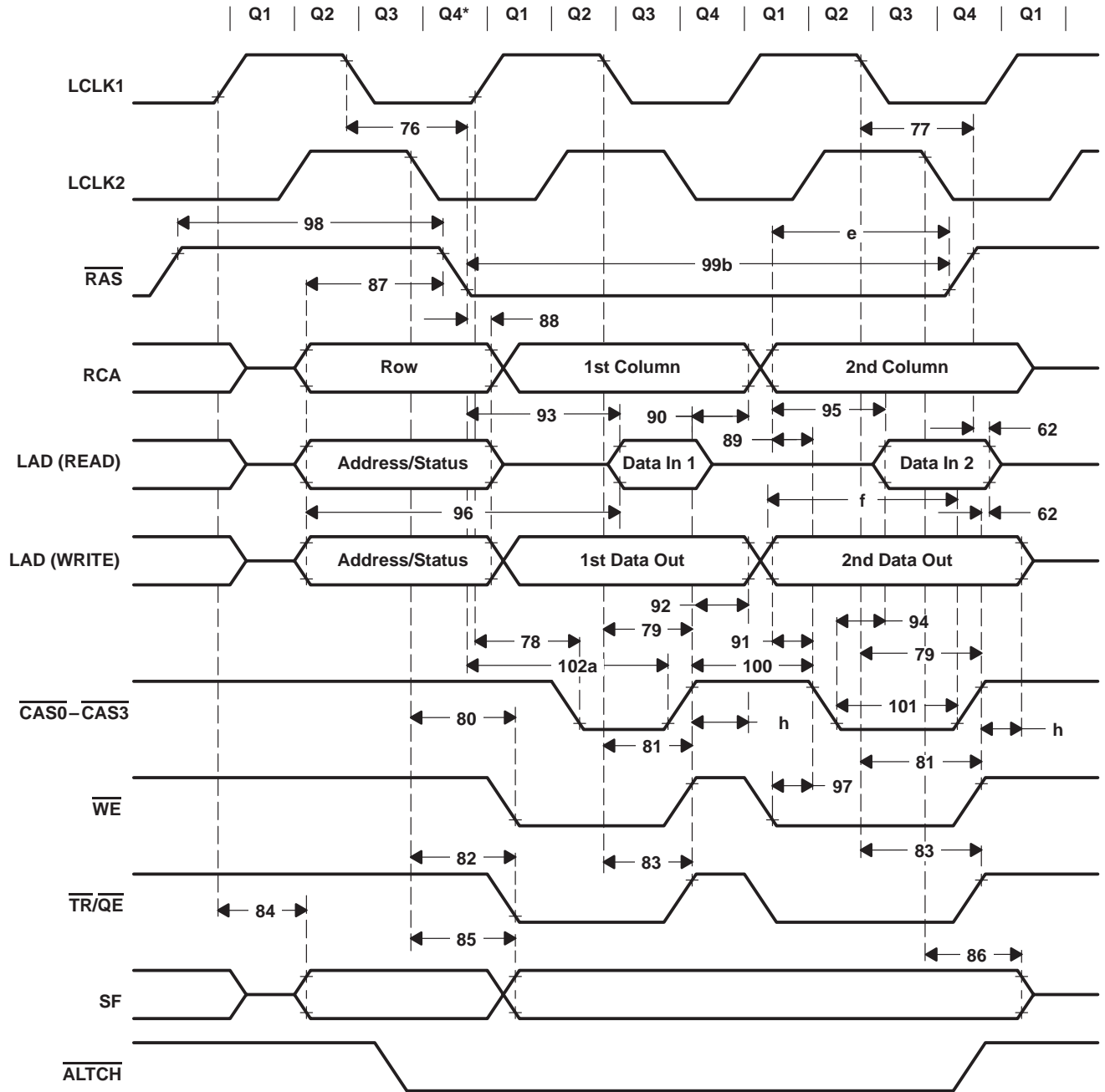

\*See clock stretch, page 21.

Figure 42. Local Bus Timing:  $\overline{\text{RAS}}$ ,  $\overline{\text{CAS0-CAS3}}$ ,  $\overline{\text{WE}}$ ,  $\overline{\text{TR/QE}}$ , and SF

PARAMETER MEASUREMENT INFORMATION

CAS-before-RAS refresh: RAS and CAS0-CAS3

NO.	PARAMETER	'34020-32 '34020A-32		'34020A-40		UNIT
		MIN	MAX	MIN	MAX	
76	$t_d(\text{CK1}\downarrow\text{-REL})$ Delay time, $\overline{\text{RAS}}$ low after LCLK1 $\downarrow$		$t_Q + 12$		$t_Q + 10$	ns
77	$t_d(\text{CK1}\downarrow\text{-REH})$ Delay time, $\overline{\text{RAS}}$ high after LCLK1 $\downarrow$		$t_Q + 12$		$t_Q + 10$	ns
78	$t_d(\text{CK1}\uparrow\text{-CEL})$ Delay time, $\overline{\text{CAS}}$ low after LCLK1 $\uparrow$		$t_Q + 12$		$t_Q + 10$	ns
79	$t_d(\text{CK1}\downarrow\text{-CEH})$ Delay time, $\overline{\text{CAS}}$ high after LCLK1 $\downarrow$		$t_Q + 12$		$t_Q + 10$	ns
102a	$t_d(\text{REL-CE}\uparrow)$ Delay time, $\overline{\text{RAS}}$ low to $\overline{\text{CAS}}\uparrow$	$4t_Q - 12 + s$		$4t_Q - 4 + s$		ns
102b	$t_d(\text{REL-CE}\uparrow)$ Delay time, $\overline{\text{RAS}}$ low to $\overline{\text{CAS}}\uparrow$	$4t_Q - 12$		$4t_Q - 4$		ns
103	$t_d(\text{CEL-RE}\downarrow)$ Delay time, $\overline{\text{CAS}}$ low to $\overline{\text{RAS}}\downarrow$	$2t_Q - 15$		$2t_Q - 13.5$		ns
104	$t_d(\text{REH-CE}\downarrow)$ Delay time, $\overline{\text{RAS}}$ high to $\overline{\text{CAS}}\downarrow$	$2t_Q - 15 + s$		$2t_Q - 13.5 + s$		ns

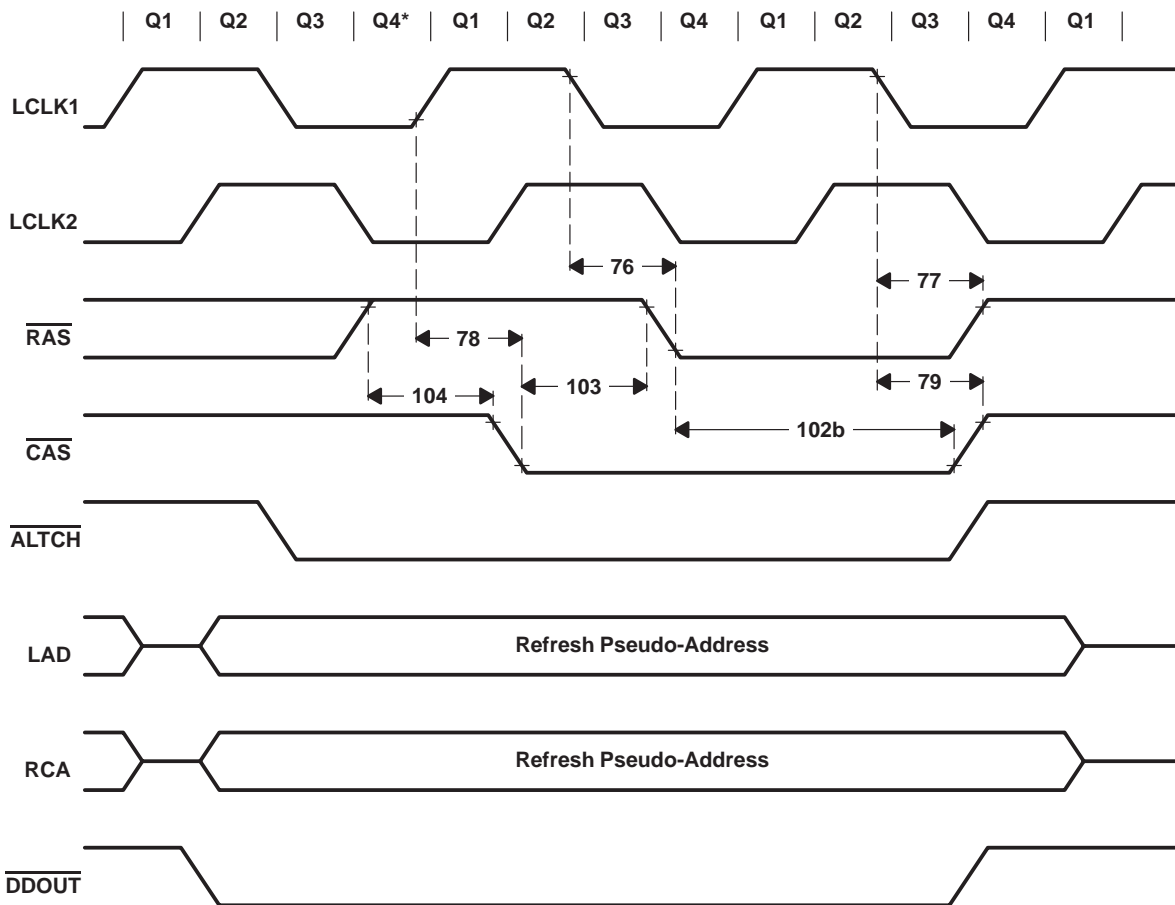

\*See clock stretch, page 21.

NOTE A: ALTCH, LAD, RCA, and DDOUT are shown for reference only.

Figure 43. CAS-Before-RAS Refresh: RAS and CAS0-CAS3

The refresh pseudo-address present on LAD0-LAD31 is the output from the 16-bit refresh address register (I/O register located at C000 01F0h) on LAD16-LAD31. LAD0-LAD3 have the refresh status code (status code = 0011), and LAD4-LAD15 are held low.

PARAMETER MEASUREMENT INFORMATION

multiprocessor interface timing:  $\overline{GI}$ ,  $\overline{ALTCH}$ ,  $\overline{RAS}$ ,  $\overline{R0}$  and  $\overline{R1}$  (see Figure 44)

NO.	PARAMETER	'34020-32 '34020A-32		'34020A-40		UNIT
		MIN	MAX	MIN	MAX	
105	$t_{a(GIV-RQV)}$ Access time, $\overline{GI}$ valid after $\overline{R0}$ and $\overline{R1}$ valid (see Notes 5 and 6)		$2t_Q - 40$		$2t_Q - 30$	ns
j	$t_{su(GIV-CK1\uparrow)}$ Setup time, $\overline{GI}$ valid before LCLK1 no longer low (see Note 6)	40		35		ns
106	$t_{h(CK1\uparrow-GIV)}$ Hold time, $\overline{GI}$ valid after LCLK1 $\uparrow$ (see Note 5)	0		0		ns
107	$t_{d(CK2\uparrow-RQV)}$ Delay time, LCLK2 $\uparrow$ to $\overline{R0}$ or $\overline{R1}$ valid		$t_Q + 15$		$t_Q + 13.5$	ns
108	$t_{d(CK2H-RQNV)}$ Delay time, LCLK2 high to $\overline{R0}$ or $\overline{R1}$ no longer valid	$t_Q - 15$		$t_Q - 13.5$		ns

NOTES: 5. These timings must be met to insure that the  $\overline{GI}$  input is recognized on this clock cycle.  
 6. It is required that either specification j or specification 105 be observed for the multiprocessor interface to function correctly. It is not necessary for both to be met.

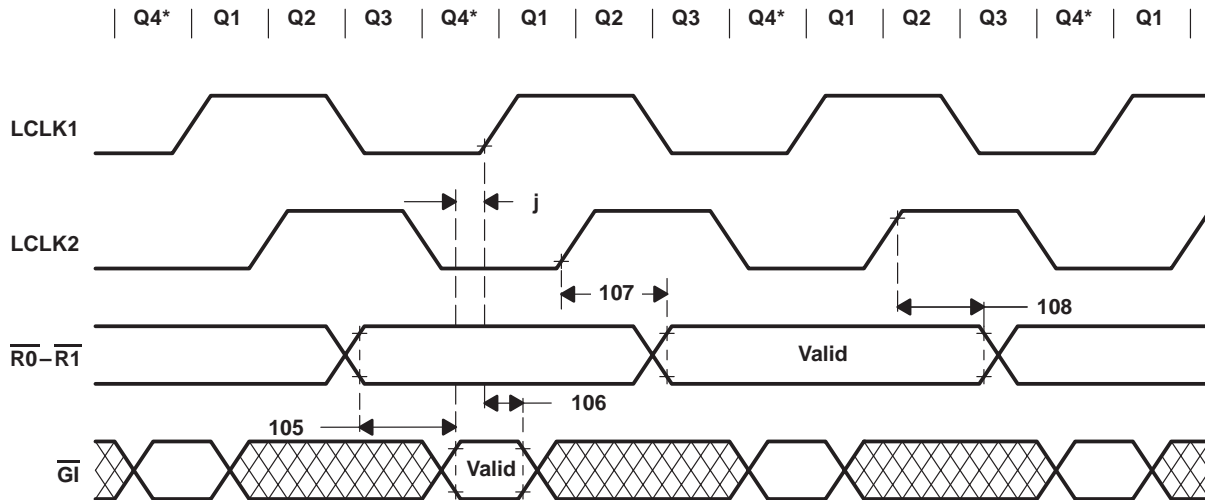

\*See clock stretch, page 21.

Figure 44. Multiprocessor Interface Timing:  $\overline{GI}$ ,  $\overline{ALTCH}$ ,  $\overline{RAS}$ ,  $\overline{R0}$  and  $\overline{R1}$



PARAMETER MEASUREMENT INFORMATION

multiprocessor interface timing: high-impedance signals

NO.	PARAMETER	'34020-32 '34020A-32		'34020A-40		UNIT
		MIN	MAX	MIN	MAX	
84	$t_d(\text{CK1}\uparrow\text{-SFV})$ Delay time, SF valid after LCLK1 $\uparrow$		$t_Q+22$		$t_Q+20$	ns
86	$t_d(\text{CK2}\downarrow\text{-SFZ})$ Delay time, SF high-impedance after LCLK2 $\downarrow$		$t_Q+22+s^\dagger$		$t_Q+20+s^\dagger$	ns
109	$t_d(\text{CK2}\downarrow\text{-ADZ})$ Delay time, LAD and RCA high-impedance after LCLK2 $\downarrow$		$t_Q+22+s^\dagger$		$t_Q+20+s^\dagger$	ns
110	$t_d(\text{CK1}\uparrow\text{-ADV})$ Delay time, LAD and RCA valid after LCLK1 $\uparrow$		$t_Q+22$		$t_Q+20$	ns
111	$t_d(\text{CK1}\uparrow\text{-CTZ})$ Delay time, $\overline{\text{ALTCH}}$ , $\overline{\text{RAS}}$ , $\overline{\text{CAS}}$ , $\overline{\text{WE}}$ , $\overline{\text{TR/QE}}$ , $\overline{\text{HOE}}$ , and HDST high-impedance after LCLK1 $\uparrow$		$t_Q+15^\dagger$		$t_Q+13.5^\dagger$	ns
112	$t_d(\text{CK2}\downarrow\text{-CTH})$ Delay time, $\overline{\text{ALTCH}}$ , $\overline{\text{RAS}}$ , $\overline{\text{CAS}}$ , $\overline{\text{WE}}$ , $\overline{\text{TR/QE}}$ , $\overline{\text{HOE}}$ , and HDST high-impedance after LCLK2 $\downarrow$		$t_Q+15+s$		$t_Q+13.5+s$	ns
113	$t_d(\text{CK1}\uparrow\text{-DIZ})$ Delay time, DDIN high-impedance after LCLK1 $\uparrow$		$t_Q+15^\dagger$		$t_Q+13.5^\dagger$	ns
114	$t_d(\text{CK2}\downarrow\text{-DIL})$ Delay time, DDIN low after LCLK2 $\downarrow$		$t_Q+15+s$		$t_Q+13.5+s$	ns
115	$t_d(\text{CK2}\downarrow\text{-DOZ})$ Delay time, $\overline{\text{DDOOUT}}$ high-impedance after LCLK2 $\downarrow$		$t_Q+15+s^\dagger$		$t_Q+13.5+s^\dagger$	ns
116	$t_d(\text{CK2}\downarrow\text{-DOH})$ Delay time, $\overline{\text{DDOOUT}}$ high after LCLK2 $\downarrow$		$t_Q+15+s$		$t_Q+13.5+s$	ns

$^\dagger$  These values are derived from characterization data and are not tested.

PARAMETER MEASUREMENT INFORMATION

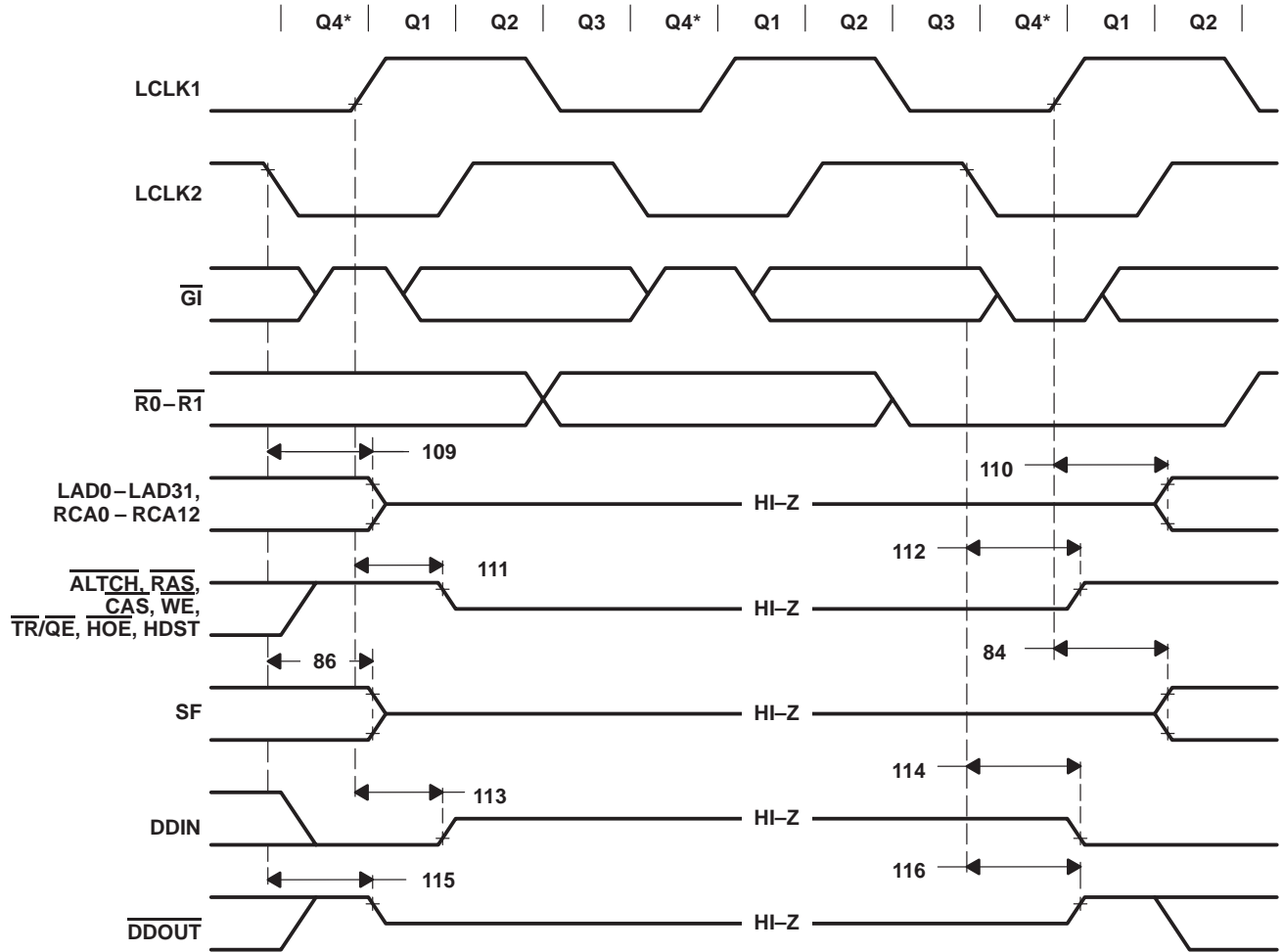

\*See clock stretch, page 21.

Figure 45. Multiprocessor Interface Timing: High-Impedance Signals

PARAMETER MEASUREMENT INFORMATION

video shift clock timing: SCLK

NO.	PARAMETER	'34020-32 '34020A-32		'34020A-40		UNIT
		MIN	MAX	MIN	MAX	
117	$t_c(\text{SCK})$ Period of video serial clock SCLK	35	50	25	50	ns
118	$t_w(\text{SCKH})$ Pulse duration of SCLK high	12		10		ns
119	$t_w(\text{SCKL})$ Pulse duration of SCLK low	12		10		ns
120	$t_t(\text{SCK})$ Transition time (rise and fall) of SCLK	2†	5†	2†	5†	ns

† This value is determined through computer simulation and is not tested.

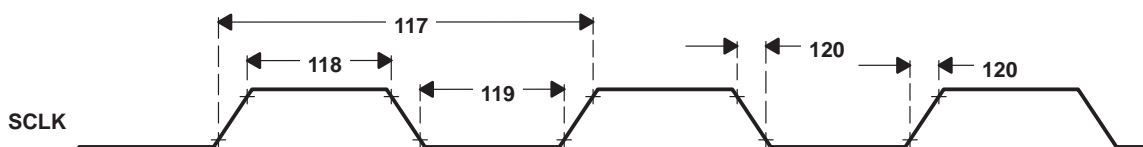

Figure 46. Video Shift Clock Timing: SCLK

PARAMETER MEASUREMENT INFORMATION

video interface timing: VCLK and video outputs

NO.	PARAMETER	'34020-32 '34020A-32		'34020A-40		UNIT
		MIN	MAX	MIN	MAX	
123	$t_c(VCK)$ Period of video input clock VCLK	62.5	100	62.5	100	ns
124	$t_w(VCKH)$ Pulse duration of VCLK high	28		28		ns
125	$t_w(VCKL)$ Pulse duration of VCLK low	28		28		ns
126	$t_t(VCK)$ Transition time (rise and fall) of VCLK	2†	5†	2†	5†	ns
127	$t_d(VCKL-HSL)$ Delay time, VCLK low to $\overline{HSYNC}$ , $\overline{VSYNC}$ , $\overline{CSYNC/VBLNK}$ or $\overline{CBLNK/VBLNK}$ low		40		40	ns
128	$t_d(VCKL-HSH)$ Delay time, VCLK low to $\overline{HSYNC}$ , $\overline{VSYNC}$ , $\overline{CSYNC/HBLNK}$ , or $\overline{CBLNK/VBLNK}$ high		40		40	ns
129	$t_h(VCK\downarrow-HS\downarrow)$ Hold time, VCLK↓ to $\overline{HSYNC}$ , $\overline{VSYNC}$ , $\overline{CSYNC/HBLNK}$ , or $\overline{CBLNK/VBLNK}\downarrow$	0†		0†		ns
130	$t_h(VCK\downarrow-HS\uparrow)$ Hold time, VCLK↓ to $\overline{HSYNC}$ , $\overline{VSYNC}$ , $\overline{CSYNC/HBLNK}$ , or $\overline{CBLNK/VBLNK}\uparrow$	0†		0†		ns

† This value is determined through computer simulation and is not tested.

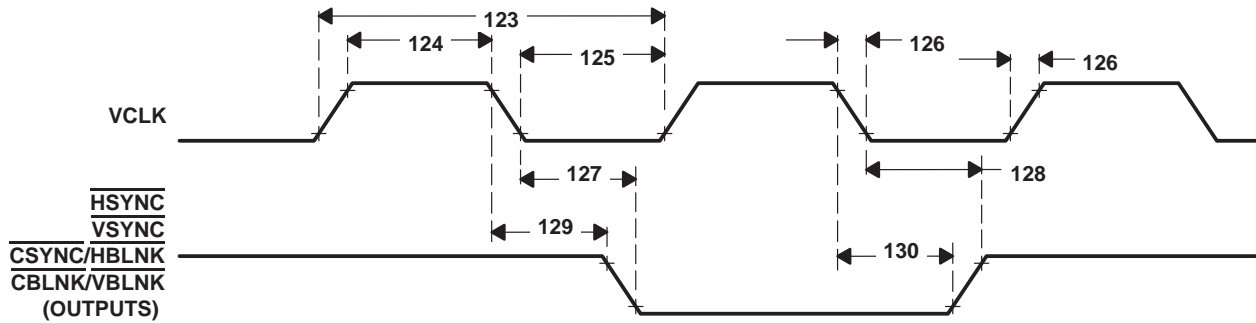

Figure 47. Video Interface Timing: VCLK and Video Outputs

PARAMETER MEASUREMENT INFORMATION

video interface timing: external sync inputs (see Note 7)

NO.	PARAMETER	'34020-32 '34020A-32		'34020A-40		UNIT
		MIN	MAX	MIN	MAX	
131	$t_{su}(SL-VCK\uparrow)$ Setup time, $\overline{HSYNC}$ , $\overline{VSYNC}$ , $\overline{CSYNC}$ low to $VCLK\uparrow$	20		20		ns
132	$t_{su}(SH-VCK\uparrow)$ Setup time, $\overline{HSYNC}$ , $\overline{VSYNC}$ , $\overline{CSYNC}$ high to $VCLK\uparrow$	20		20		ns
133	$t_h(VCKH-SV)$ Hold time, $\overline{HSYNC}$ , $\overline{VSYNC}$ , $\overline{CSYNC}$ valid after $VCLK$ high	20		20		ns

NOTE 7: Setup and hold times on asynchronous inputs are required only to assure recognition at indicated clock edges.

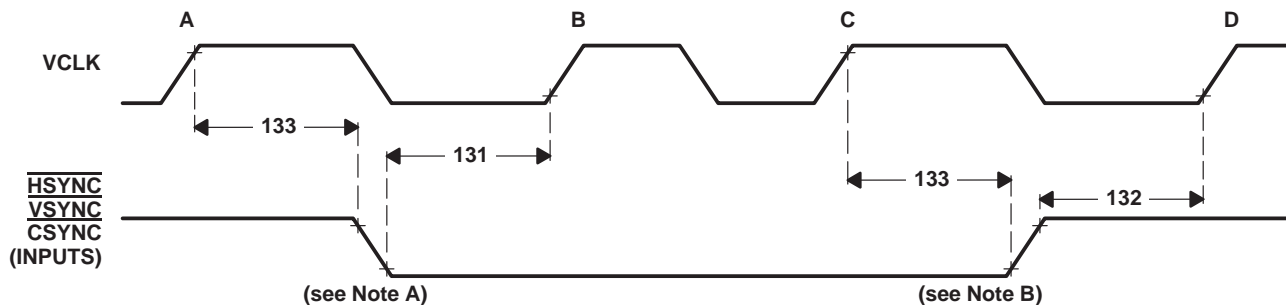

- NOTES: A. If the falling edge of the sync signal occurs more than  $t_h(VCKH-SV)$  after  $VCLK$  edge A and at least  $t_{su}(SL-VCKH\uparrow)$  before edge B, the transition will be detected at edge B instead of edge A.  
 B. If the rising edge of the sync signal occurs more than  $t_h(VCKH-SV)$  after  $VCLK$  edge C and at least  $t_{su}(SH-VCKH\uparrow)$  before edge D, the transition will be detected at edge D instead of edge C.

Figure 48. Video Interface Timing: External Sync Inputs

PARAMETER MEASUREMENT INFORMATION

interrupt timing:  $\overline{\text{LINT1}}$  and  $\overline{\text{LINT2}}$

NO.	PARAMETER	'34020-32 '34020A-32		'34020A-40		UNIT
		MIN	MAX	MIN	MAX	
134	$t_{su}(\overline{\text{LINTL}}-\text{CK2}\uparrow)$ Setup time, $\overline{\text{LINT1}}$ or $\overline{\text{LINT2}}$ low before LCLK2 $\uparrow$	$t_Q+45$	†	$t_Q+40$	†	ns
135	$t_w(\overline{\text{LINTL}})$ Pulse duration of $\overline{\text{LINT1}}$ or $\overline{\text{LINT2}}$ low	$8t_Q$	‡	$8t_Q$	‡	ns

† Although  $\overline{\text{LINT1}}$  and  $\overline{\text{LINT2}}$  can be asynchronous to the TMS34020, this setup insures recognition of the interrupt on this clock edge.

‡ This pulse duration minimum insures that the interrupt is recognized by internal logic; however, the level must be maintained until it has been acknowledged by the interrupt service routine.

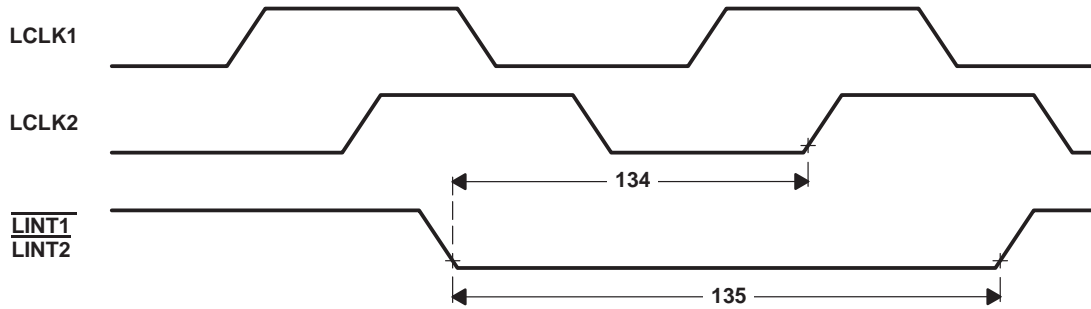

Figure 49. Interrupt Timing:  $\overline{\text{LINT1}}$  and  $\overline{\text{LINT2}}$

host interrupt timing:  $\overline{\text{HINT}}$

NO.	PARAMETER	'34020-32 '34020A-32		'34020A-40		UNIT
		MIN	MAX	MIN	MAX	
136	$t_d(\text{CK1}\uparrow-\overline{\text{HINTV}})$ Delay time, LCLK1 $\uparrow$ to $\overline{\text{HINT}}$ valid		30		25	ns

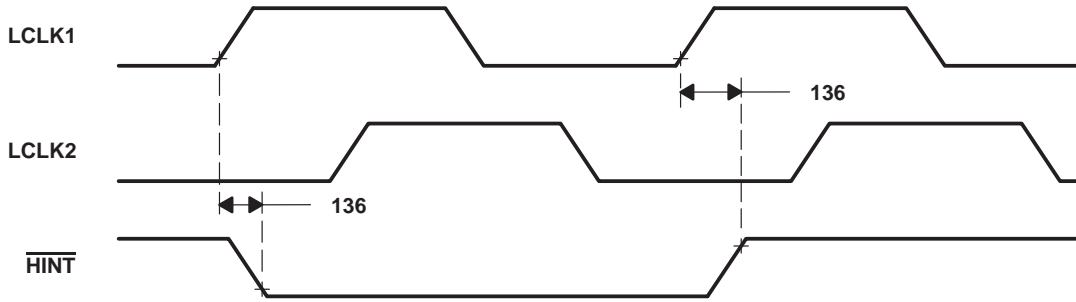

Figure 50. Host Interrupt Timing:  $\overline{\text{HINT}}$

PARAMETER MEASUREMENT INFORMATION

emulator interface timing

NO.	PARAMETER	'34020-32 '34020A-32	'34020A-40	UNIT
		MIN MAX	MIN MAX	
137	$t_{su}(EMV-CK1\uparrow)$ Setup time, EMU0–EMU2 valid to LCLK1 $\uparrow$	30	25	ns
138	$t_h(EMV-CK1\uparrow)$ Hold time, EMU0–EMU2 valid after LCLK1 $\uparrow$	0	0	ns
139	$t_d(CK1L-SCV)$ Delay time, EMU3 valid after LCLK1 low	25	20	ns
140	$t_h(CK2H-SCNV)$ Hold time, LCLK2 high before EMU3 not valid	$t_Q - 15$	$t_Q - 13.5$	ns

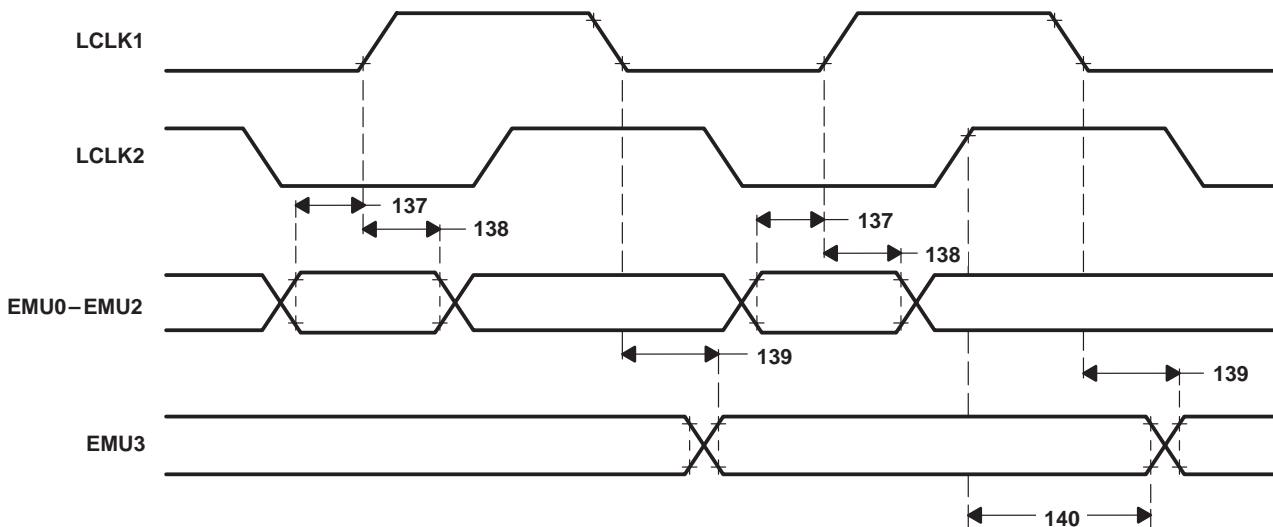

Figure 51. Emulator Interface Timing

# TMS34020, TMS34020A GRAPHICS PROCESSORS

SPVS004D – MARCH 1990 – REVISED NOVEMBER 1993

## MECHANICAL DATA

GB/S-CPGA-P145

CERAMIC PIN GRID ARRAY PACKAGE, CAVITY UP

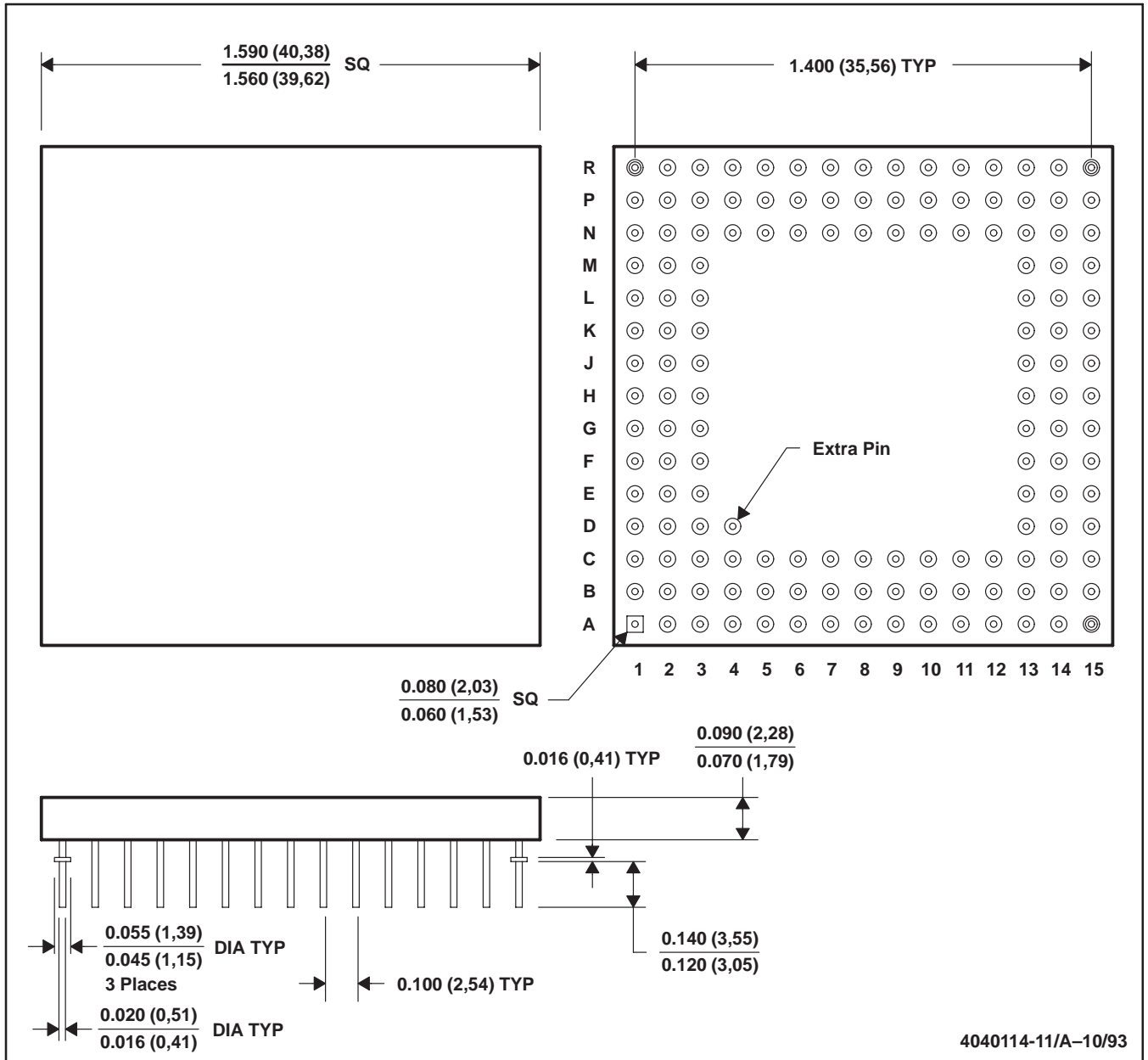

- NOTES:
- A. All linear dimensions are in inches (millimeters).
  - B. This drawing is subject to change without notice.
  - C. Index mark may appear on top or bottom depending on package vendor.
  - D. Pins are located within 0.005 (0,13) radius of true position relative to each other at maximum material condition and within 0.051 (0,38) radius relative to the center of the ceramic.
  - E. This is a hermetically sealed ceramic package with metal and gold-plated pins.



MECHANICAL DATA

PCM/S-PQFP-G\*\*\*

PLASTIC QUAD FLATPACK

144-PIN SHOWN

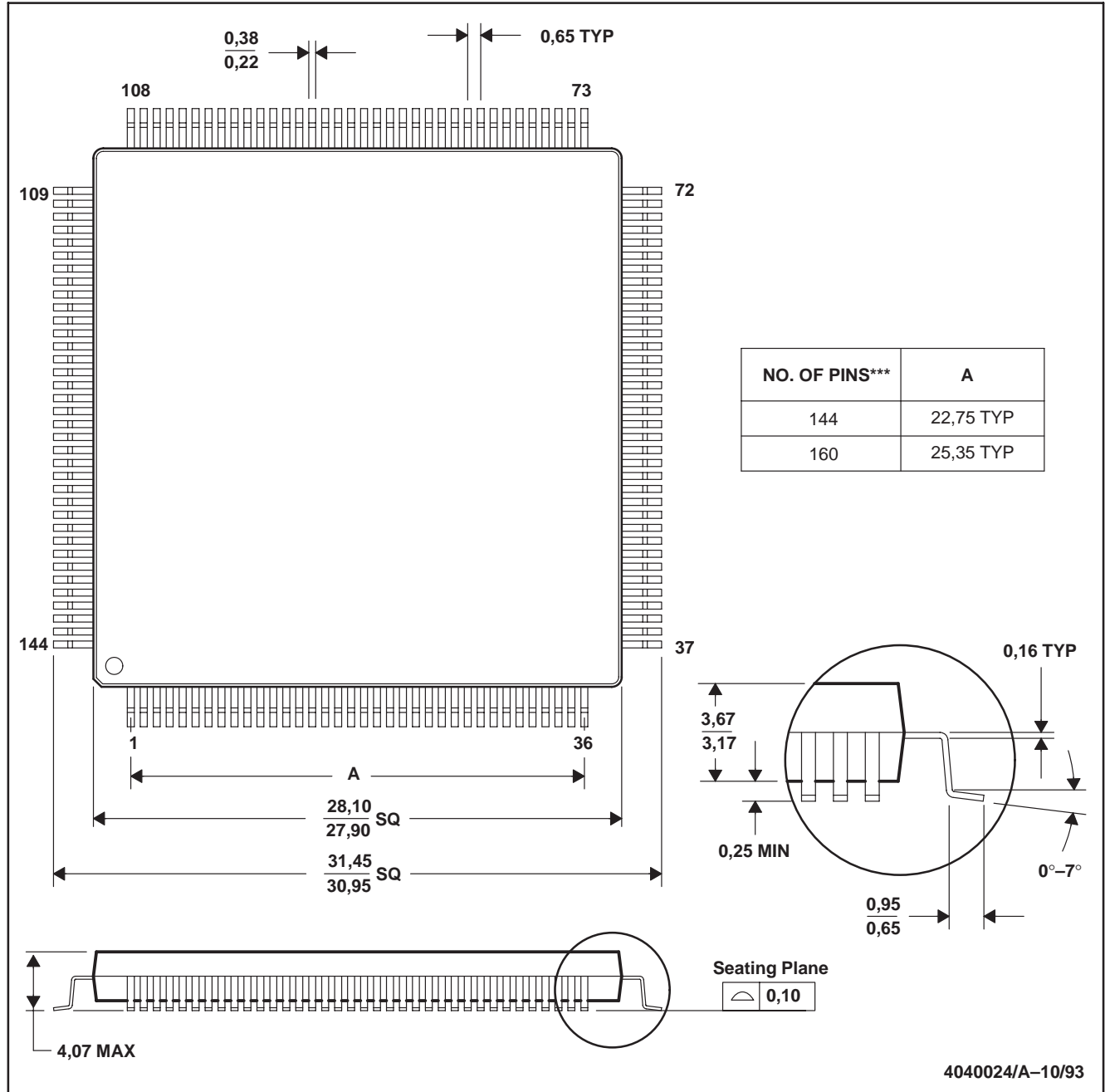

- NOTES: A. All linear dimensions are in millimeters.  
 B. This drawing is subject to change without notice.  
 C. Falls within JEDEC MO-108.  
 D. The 144PCM is identical to 160PCM except for 4 leads per corner are removed.

## IMPORTANT NOTICE

Texas Instruments and its subsidiaries (TI) reserve the right to make changes to their products or to discontinue any product or service without notice, and advise customers to obtain the latest version of relevant information to verify, before placing orders, that information being relied on is current and complete. All products are sold subject to the terms and conditions of sale supplied at the time of order acknowledgement, including those pertaining to warranty, patent infringement, and limitation of liability.

TI warrants performance of its semiconductor products to the specifications applicable at the time of sale in accordance with TI's standard warranty. Testing and other quality control techniques are utilized to the extent TI deems necessary to support this warranty. Specific testing of all parameters of each device is not necessarily performed, except those mandated by government requirements.

CERTAIN APPLICATIONS USING SEMICONDUCTOR PRODUCTS MAY INVOLVE POTENTIAL RISKS OF DEATH, PERSONAL INJURY, OR SEVERE PROPERTY OR ENVIRONMENTAL DAMAGE ("CRITICAL APPLICATIONS"). TI SEMICONDUCTOR PRODUCTS ARE NOT DESIGNED, AUTHORIZED, OR WARRANTED TO BE SUITABLE FOR USE IN LIFE-SUPPORT DEVICES OR SYSTEMS OR OTHER CRITICAL APPLICATIONS. INCLUSION OF TI PRODUCTS IN SUCH APPLICATIONS IS UNDERSTOOD TO BE FULLY AT THE CUSTOMER'S RISK.

In order to minimize risks associated with the customer's applications, adequate design and operating safeguards must be provided by the customer to minimize inherent or procedural hazards.

TI assumes no liability for applications assistance or customer product design. TI does not warrant or represent that any license, either express or implied, is granted under any patent right, copyright, mask work right, or other intellectual property right of TI covering or relating to any combination, machine, or process in which such semiconductor products or services might be or are used. TI's publication of information regarding any third party's products or services does not constitute TI's approval, warranty or endorsement thereof.