



Intel[®] 815 Chipset Family: 82815 Graphics and Memory Controller Hub (GMCH)

Datasheet

June 2000

Document Reference Number: 290688-001



Information in this document is provided in connection with Intel products. No license, express or implied, by estoppel or otherwise, to any intellectual property rights is granted by this document. Except as provided in Intel's Terms and Conditions of Sale for such products, Intel assumes no liability whatsoever, and Intel disclaims any express or implied warranty, relating to sale and/or use of Intel products including liability or warranties relating to fitness for a particular purpose, merchantability, or infringement of any patent, copyright or other intellectual property right. Intel products are not intended for use in medical, life saving, or life sustaining applications.

Intel may make changes to specifications and product descriptions at any time, without notice.

Designers must not rely on the absence or characteristics of any features or instructions marked "reserved" or "undefined." Intel reserves these for future definition and shall have no responsibility whatsoever for conflicts or incompatibilities arising from future changes to them.

The Intel® 815 chipset GMCH may contain design defects or errors known as errata which may cause the product to deviate from published specifications. Current characterized errata are available on request.

Contact your local Intel sales office or your distributor to obtain the latest specifications and before placing your product order.

I²C is a 2-wire communications bus/protocol developed by Philips. SMBus is a subset of the I²C bus/protocol and was developed by Intel. Implementations of the I²C bus/protocol may require licenses from various entities, including Philips Electronics N.V. and North American Philips Corporation.

Alert on LAN is a result of the Intel-IBM Advanced Manageability Alliance and a trademark of IBM

Copies of documents which have an ordering number and are referenced in this document, or other Intel literature, may be obtained from:

Intel Corporation

www.intel.com

or call 1-800-548-4725

*Third-party brands and names are the property of their respective owners.

Copyright © Intel Corporation 2000

Contents

1.	Overview	13
1.1.	Related Documents	13
1.2.	The Intel® 815 Chipset Family.....	14
1.3.	82815 GMCH Overview	16
1.4.	Host Interface.....	17
1.5.	System Memory Interface	17
1.6.	Multiplexed AGP and Display Cache Interface	18
1.6.1.	AGP Interface	18
1.6.2.	Display Cache Interface.....	18
1.7.	Hub Interface.....	18
1.8.	82815 GMCH Integrated Graphics Support.....	19
1.8.1.	Display, Digital Video Out, and LCD/Flat Panel/Digital CRT.....	19
1.9.	System Clocking	20
1.10.	GMCH Power Delivery	20
2.	Signal Description.....	21
2.1.	Host Interface Signals.....	22
2.2.	System Memory Interface Signals	23
2.3.	AGP Interface Signals.....	24
2.3.1.	AGP Addressing Signals.....	24
2.3.2.	AGP Flow Control Signals.....	25
2.3.3.	AGP Status Signals	25
2.3.4.	AGP Clocking Signals (Strobes).....	26
2.3.5.	AGP FRAME# Signals	27
2.4.	Display Cache Interface Signals	29
2.5.	Hub Interface Signals.....	30
2.6.	Display Interface Signals.....	30
2.7.	Digital Video Output Signals/TV-Out Pins.....	31
2.8.	Power Signals	32
2.9.	Clock Signals	32
2.10.	GMCH Power-Up/Reset Strap Options.....	33
2.11.	Multiplexed Display Cache and AGP Signal Mapping.....	34
2.11.1.	Display Cache Mapping at the AGP Connector	35
3.	Configuration Registers	37
3.1.	Register Nomenclature and Access Attributes	37
3.2.	PCI Configuration Space Access.....	38
3.2.1.	PCI Bus Configuration Mechanism.....	38
3.2.2.	Logical PCI Bus #0 Configuration Mechanism.....	39
3.2.3.	Primary PCI (PCI0) and Downstream Configuration Mechanism	39
3.2.4.	Internal Graphics Device Configuration Mechanism.....	39
3.2.5.	GMCH Register Introduction.....	39
3.3.	I/O Mapped Registers	40
3.3.1.	CONF_ADDR—Configuration Address Register	40
3.3.2.	CONF_DATA—Configuration Data Register	41

3.4.	Host-Hub Interface Bridge/DRAM Controller Device Registers (Device 0)	42
3.4.1.	VID—Vendor Identification Register (Device 0)	44
3.4.2.	DID—Device Identification Register (Device 0).....	44
3.4.3.	PCICMD—PCI Command Register (Device 0)	45
3.4.4.	PCISTS—PCI Status Register (Device 0).....	46
3.4.5.	RID—Revision Identification Register (Device 0)	47
3.4.6.	SUBC—Sub-Class Code Register (Device 0).....	47
3.4.7.	BCC—Base Class Code Register (Device 0).....	47
3.4.8.	MLT—Master Latency Timer Register (Device 0)	48
3.4.9.	HDR—Header Type Register (Device 0).....	48
3.4.10.	APBASE—Aperture Base Configuration Register (Device 0: AGP Mode Only)	48
3.4.11.	SVID—Subsystem Vendor Identification Register (Device 0)	50
3.4.12.	SID—Subsystem Identification Register (Device 0)	50
3.4.13.	CAPPTR—Capabilities Pointer (Device 0).....	50
3.4.14.	GMCHCFG—GMCH Configuration Register (Device 0)	51
3.4.15.	APCONT—Aperture Control (Device 0)	53
3.4.16.	DRP—DRAM Row Population Register (Device 0).....	54
3.4.17.	DRAMT—DRAM Timing Register (Device 0).....	55
3.4.18.	DRP2—DRAM Row Population Register 2 (Device 0).....	56
3.4.19.	FDHC—Fixed DRAM Hole Control Register (Device 0).....	57
3.4.20.	PAM—Programmable Attributes Map Registers (Device 0).....	57
3.4.21.	SMRAM—System Management RAM Control Register (Device 0)	62
3.4.22.	MISCC—Miscellaneous Control Register (Device 0)	64
3.4.23.	CAPID—Capability Identification (Device 0: AGP Mode Only).....	66
3.4.24.	BUFF_SC—System Memory Buffer Strength Control Register (Device 0)	67
3.4.25.	BUFF_SC2—System Memory Buffer Strength Control Register 2 (Device 0)	70
3.4.26.	SM_RCOMP—System Memory R Compensation Control Register (Device 0)	71
3.4.27.	SM—System Memory Control Register.....	72
3.4.28.	ACAPID—AGP Capability Identifier Register (Device 0: AGP Mode Only)	73
3.4.29.	AGPSTAT—AGP Status Register (Device 0: AGP Mode Only)	74
3.4.30.	AGPCMD—AGP Command Register (Device 0: AGP Mode Only)	75
3.4.31.	AGPCTRL—AGP Control Register (Device 0: AGP Mode Only).....	76
3.4.32.	APSIZE—Aperture Size (Device 0: AGP Mode Only)	77
3.4.33.	ATTBASE—Aperture Translation Table Base Register (Device 0: AGP Mode Only)	78
3.4.34.	AMTT—AGP Multi-Transaction Timer (Device 0: AGP Mode Only)	79
3.4.35.	LPTT—AGP Low Priority Transaction Timer Register (Device 0: AGP Mode Only)	80
3.4.36.	GMCHCFG—GMCH Configuration Register (Device 0: AGP Mode Only)	81
3.4.37.	ERRCMD—Error Command Register (Device 0: AGP Mode Only).....	82
3.5.	AGP/PCI Bridge Registers (Device 1: Visible in AGP Mode Only).....	84
3.5.1.	VID1—Vendor Identification Register (Device 1)	85
3.5.2.	DID1—Device Identification Register (Device 1).....	85
3.5.3.	PCICMD1—PCI-PCI Command Register (Device 1)	85
3.5.4.	PCISTS1—PCI-PCI Status Register (Device 1).....	87
3.5.5.	RID1—Revision Identification Register (Device 1)	88
3.5.6.	SUBC1—Sub-Class Code Register (Device 1).....	88
3.5.7.	BCC1—Base Class Code Register (Device 1).....	88

3.5.8.	MLT1—Master Latency Timer Register (Device 1)	89
3.5.9.	HDR1—Header Type Register (Device 1)	89
3.5.10.	PBUSN—Primary Bus Number Register (Device 1).....	89
3.5.11.	SBUSN—Secondary Bus Number Register (Device 1).....	90
3.5.12.	SUBUSN—Subordinate Bus Number Register (Device 1)	90
3.5.13.	SMLT—Secondary Master Latency Timer Register (Device 1)	91
3.5.14.	IOBASE—I/O Base Address Register (Device 1)	92
3.5.15.	IOLIMIT—I/O Limit Address Register (Device 1).....	93
3.5.16.	SSTS—Secondary PCI-PCI Status Register (Device 1).....	94
3.5.17.	MBASE—Memory Base Address Register (Device 1).....	95
3.5.18.	MLIMIT—Memory Limit Address Register (Device 1)	96
3.5.19.	PMBASE—Prefetchable Memory Base Address Register (Device 1).....	97
3.5.20.	PMLIMIT—Prefetchable Memory Limit Address Register (Device 1).....	98
3.5.21.	BCTRL—PCI-PCI Bridge Control Register (Device 1).....	99
3.5.22.	ERRCMD1—Error Command Register (Device 1)	101
3.6.	Graphics Device Registers (Device 2: VISIBLE IN GFX Mode Only)	102
3.6.1.	VID2—Vendor Identification Register (Device 2).....	103
3.6.2.	DID2—Device Identification Register (Device 2)	103
3.6.3.	PCICMD2—PCI Command Register (Device 2).....	104
3.6.4.	PCISTS2—PCI Status Register (Device 2)	105
3.6.5.	RID2—Revision Identification Register (Device 2)	106
3.6.6.	PI—Programming Interface Register (Device 2)	106
3.6.7.	SUBC2—Sub-Class Code Register (Device 2)	106
3.6.8.	BCC2—Base Class Code Register (Device 2)	107
3.6.9.	CLS—Cache Line Size Register (Device 2)	107
3.6.10.	MLT2—Master Latency Timer Register (Device 2)	107
3.6.11.	HDR2—Header Type Register (Device 2)	108
3.6.12.	BIST—BIST Register (Device 2).....	108
3.6.13.	GMADR—Graphics Memory Range Address Register (Device 2).....	109
3.6.14.	MMADR—Memory Mapped Range Address Register (Device 2)	110
3.6.15.	SVID—Subsystem Vendor Identification Register (Device 2).....	110
3.6.16.	SID—Subsystem Identification Register (Device 2).....	111
3.6.17.	ROMADR—Video BIOS ROM Base Address Register (Device 2).....	111
3.6.18.	CAPPOINT—Capabilities Pointer Register (Device 2)	111
3.6.19.	INTRLINE—Interrupt Line Register (Device 2).....	112
3.6.20.	INTRPIN—Interrupt Pin Register (Device 2).....	112
3.6.21.	MINGNT—Minimum Grant Register (Device 2).....	112
3.6.22.	MAXLAT—Maximum Latency Register (Device 2).....	112
3.6.23.	PM_CAPID—Power Management Capabilities ID Register (Device 2).....	113
3.6.24.	PM_CAP—Power Management Capabilities Register (Device 2).....	113
3.6.25.	PM_CS—Power Management Control/Status Register (Device 2)	114
3.7.	Display Cache Interface	115
3.7.1.	DRT—DRAM Row Type	115
3.7.2.	DRAMCL—DRAM Control Low	116
3.7.3.	DRAMCH—DRAM Control High	117
3.8.	Display Cache Detect and Diagnostic Registers.....	118
3.8.1.	GRX—GRX Graphics Controller Index Register	118
3.8.2.	MSR—Miscellaneous Output.....	119
3.8.3.	GR06—Miscellaneous Register.....	119
3.8.4.	GR10—Address Mapping	120
3.8.5.	GR11—Page Selector	120

4.	Functional Description.....	121
4.1.	System Address Map	121
4.1.1.	Memory Address Ranges	122
4.1.2.	Compatibility Area	123
4.1.3.	Extended Memory Area.....	125
4.1.3.1.	System Management Mode (SMM) Memory Range	128
4.2.	Memory Shadowing	129
4.3.	I/O Address Space	129
4.3.1.	GMCH Decode Rules and Cross-Bridge Address Mapping	129
4.3.2.	Address Decode Rules.....	130
4.3.2.1.	AGP Interface Decode Rules.....	131
4.3.2.2.	Legacy VGA Ranges	132
4.4.	Host Interface	133
4.4.1.	Host Bus Device Support	133
4.4.2.	Special Cycles	135
4.5.	System Memory DRAM Interface	136
4.5.1.	DRAM Organization and Configuration	136
4.5.1.1.	Configuration Mechanism For DIMMs	137
4.5.1.2.	DRAM Register Programming	138
4.5.2.	DRAM Address Translation and Decoding.....	138
4.5.3.	DRAM Array Connectivity	139
4.5.4.	SDRAMT Register Programming	140
4.5.5.	SDRAM Paging Policy.....	140
4.6.	Intel® Dynamic Video Memory Technology (D.V.M.T.).....	140
4.7.	Display Cache Interface.....	141
4.7.1.	Supported DRAM Types for Display Cache Memory	141
4.7.2.	Memory Configurations	142
4.7.3.	Address Translation	143
4.7.4.	Display Cache Interface Timing	143
4.8.	Internal Graphics Device	144
4.8.1.	3D/2D Instruction Processing.....	144
4.8.2.	3D Engine.....	145
4.8.3.	Buffers	145
4.8.4.	Setup	146
4.8.5.	Texturing.....	146
4.8.6.	2D Operation	148
4.8.7.	Fixed Blitter (BLT) and Stretch Blitter (STRBLT) Engines.....	148
4.8.7.1.	Fixed BLT Engine	149
4.8.7.2.	Arithmetic Stretch BLT Engine.....	149
4.8.8.	Hardware Motion Compensation.....	149
4.8.9.	Hardware Cursor	150
4.8.10.	Overlay Engine	150
4.8.11.	Display.....	151
4.8.12.	Flat Panel/Digital CRT Interface / 1.8V TV-Out Interface.....	152
4.8.13.	DDC (Display Data Channel).....	153
4.9.	System Reset for the GMCH	154
4.10.	System Clock Description.....	154
4.11.	Power Management	154
4.11.1.	Specifications Supported.....	154

5.	Pinout and Package Information	155
5.1.	82815 GMCH Pinout	155
5.2.	Package Information	162
6.	Testability	165
6.1.	XOR TREE Testability Algorithm Example	166
6.1.1.	Test Pattern Consideration for XOR Chains 3 and 4, and 7 and 8	166
6.2.	XOR Tree Initialization	167
6.2.1.	Chain [1:6] Initialization	167
6.2.2.	Chain [7:8] Initialization	167
6.3.	XOR Chain	168
6.4.	All Z	172

Figures

Figure 1. Intel® 815 Chipset Family System Block Diagram	15
Figure 2. 82815 GMCH Block Diagram.....	16
Figure 3. PAM Registers	59
Figure 4. System Memory Address Map	122
Figure 5. Detailed Memory System Address Map.....	122
Figure 6. DRAM Array Sockets	139
Figure 7. GMCH Display Cache Interface to 4 MB.....	142
Figure 8. 3D/2D Pipeline Preprocessor.....	144
Figure 9. Data Flow for the 3D Pipeline	145
Figure 10. GMCH Pinout (Top View-Left Side)	156
Figure 11. GMCH Pinout (Top View-Right Side).....	157
Figure 12. GMCH BGA Package Dimensions (Top and Side Views)	162
Figure 13. GMCH BGA Package Dimensions (Bottom View).....	163
Figure 14. XOR Tree Implementation	165

Tables

Table 1. Supported System Bus and System Memory Bus Frequencies	20
Table 2. GMCH PCI Configuration Space (Device 0)	42
Table 3. Supported System Memory DIMM Configurations.....	54
Table 4. Attribute Bit Assignments	58
Table 5. PAM Registers and Associated Memory Segments	59
Table 6. Summary of GMCH Error Sources, Enables and Status Flags	83
Table 7. GMCH Configuration Space (Device 1)	84
Table 8. Device 2 Configuration Space Address Map (Internal Graphics).....	102
Table 9. Memory Segments and Their Attributes.....	123
Table 10. Summary of Transactions Supported By GMCH.....	133
Table 11. Host Responses Supported by the GMCH	134
Table 12. Special Cycles.....	135
Table 13. Sample Of Possible Mix And Match Options For 4 Row/2 DIMM Configurations	137
Table 14. Data Bytes on DIMM Used for Programming DRAM Registers.....	138
Table 15. GMCH DRAM Address Mux Function.....	139
Table 16. Programmable SDRAM Timing Parameters	140
Table 17. Memory Size for each configuration :	142
Table 18. GMCH Local Memory Address Mapping.....	143
Table 19. Partial List of Display Modes Supported	151
Table 20. Partial List of Flat Panel Modes Supported.....	152
Table 21. Partial List of TV-Out Modes Supported	153
Table 22. Alphabetical Pin Assignment.....	158
Table 23. Package Dimensions	163
Table 24. XOR Test Pattern Example.....	166
Table 25. XOR Chain 1 35 Inputs Output: SMAA5 (A12)	168
Table 26. XOR Chain 2 33 Inputs Output: SMAA2 (F12)	168
Table 27. XOR Chain 3 38 Inputs Output: SMAA0 (D13)	169
Table 28. XOR Chain 4 36 Inputs Output: SMAA9 (D13)	169
Table 29. XOR Chain 5 56 Inputs Output: SMD31 (K5)	170
Table 30. XOR Chain 6 60 Inputs Output: SMAA11 (A13)	171
Table 31. XOR Chain 7 33 Inputs Output: SMAA8 (D12)	171
Table 32. XOR Chain 8 31 Inputs Output: SMAA4 (B12)	172

Revision History

Rev.	Description	Date
-001	Initial Release	June 2000



This page is intentionally left blank.

82815 GMCH Features

- Processor/Host Bus Support
 - Intel® Pentium® III processor and Intel® Celeron™ Processor in FC-PGA package
 - Supports processor 370-Pin Socket
 - Supports 32-Bit System Bus Addressing
 - 4 deep in-order queue; 4 or 1 deep request queue
 - Supports Uni-processor systems only
 - In-order and Dynamic Deferred Transaction Support
 - 66/100/133MHz System Bus Frequency
 - GTL+ I/O Buffer
- Integrated SDRAM Controller
 - 32 MB to 512 MB using 16Mb/64Mb/128Mb/256Mb technology
 - Supports up to 3 double sided DIMMs at 100 MHz system memory bus
 - Supports up to 2 double sided or 3 single sided DIMMs at 133 MHz system memory bus.
 - 64-bit data interface
 - 100/133 MHz system memory bus frequency
 - Support for Asymmetrical SDRAM addressing only
 - Support for x8 and x16 SDRAM device width
 - Unbuffered, Non-ECC SDRAM only supported
 - Refresh Mechanism: CBR ONLY supported
 - Enhanced Open page arbitration SDRAM paging scheme
 - Suspend to RAM support
- Accelerated Graphics Port (AGP) Interface Multiplexed with Internal Graphics
 - Supports a single AGP device via a connector
 - Supports AGP 2.0 including 4x AGP data transfers
 - AGP Universal Connector support via dual mode buffers to allow AGP 2.0 3.3V or 1.5V signaling
 - AGP PIPE# or SBA initiated accesses to SDRAM not snooped
 - AGP FRAME# initiated accesses to SDRAM are snooped
 - High priority access support
 - Hierarchical PCI configuration mechanism
 - Delayed transaction support for AGP-to-SDRAM reads that can not be serviced immediately
- Arbitration Scheme and Concurrency
 - Intelligent Centralized Arbitration Model for Optimum Concurrency Support
 - Concurrent operations of processor and System busses supported via dedicated arbitration and data buffering
- Data Buffering
 - Distributed Data Buffering Model for optimum concurrency
 - SDRAM Write Buffer with read-around-write capability
 - Dedicated processor –SDRAM, hub interface-SDRAM and Graphics-SDRAM Read Buffers
- Power Management Functions
 - SMRAM space remapping to A0000h (128 KB)
 - Optional Extended SMRAM space above 256 MB, additional 512 KB / 1MB TSEG from Top of Memory, cacheable
 - Stop Clock Grant and Halt special cycle translation from the host to the hub interface
 - ACPI Compliant power management
 - APIC Buffer Management
 - SMI, SCI, and SERR error indication
- Integrated Graphics Controller Multiplexed with AGP Controller
 - 3D Hyper Pipelined Architecture
 - -Parallel Data Processing (PDP)
 - -Precise Pixel Interpolation (PPI)
 - Full 2D H/W Acceleration
 - Motion Video Acceleration
 - Supports 133 MHz System Memory while running in non-CPC mode
- 3D Graphics Visual Enhancements
 - Flat & Gouraud Shading
 - Mip Maps with Trilinear and Anisotropic Filtering
 - Full Color Specular
 - Fogging Atmospheric Effects
 - Z Buffering
 - 3D Pipe 2D Clipping
 - Backface Culling
- 3D Graphics Texturing Enhancements
 - Per Pixel Perspective Correction Texture Mapping
 - Texture Compositing
 - Texture Color Keying/Chroma Keying
- Digital Video Output
 - 85 MHz Flat Panel Monitor/Digital CRT Interface Or Digital Video Output for use with a external TV encoder
- Display
 - Integrated 24-bit 230 MHz RAMDAC
 - Gamma Corrected Video
 - DDC2B Compliant
- 2D Graphics
 - Up to 1600x1200 in 8-bit Color at 85 Hz Refresh
 - Hardware Accelerated Functions
 - 3 Operand Raster BitBLTs
 - 64x64x3 Color Transparent Cursor
- Arithmetic Stretch Blitter Video
 - H/W Motion Compensation Assistance for S/W MPEG2 Decode
 - Software DVD at 30 fps
 - Digital Video Out Port
 - NTSC and PAL TV Out Support
 - H/W Overlay Engine with Bilinear Filtering
 - Independent gamma correction, saturation, brightness & contrast for overlay
- Integrated Graphics Memory Controller
 - Intel® D.V.M. Technology
- Display Cache Interface multiplexed on the AGP interface
 - 32-bit data interface
 - 133 MHz SDRAM interface only.
 - Flexible AGP In-Line Memory Module (AIMM) Implementation
 - Support for 2 1Mx16, or 1 2Mx32 on AIMM card
 - 4 MB maximum addressable
- Supporting I/O Bridge
 - 82801AA I/O Controller Hub (ICH)
 - 82801BA I/O Controller Hub (ICH2)
- Packaging/Power
 - 544 BGA
 - 1.85V core with 3.3V CMOS I/O

82815 GMCH Simplified Block Diagram

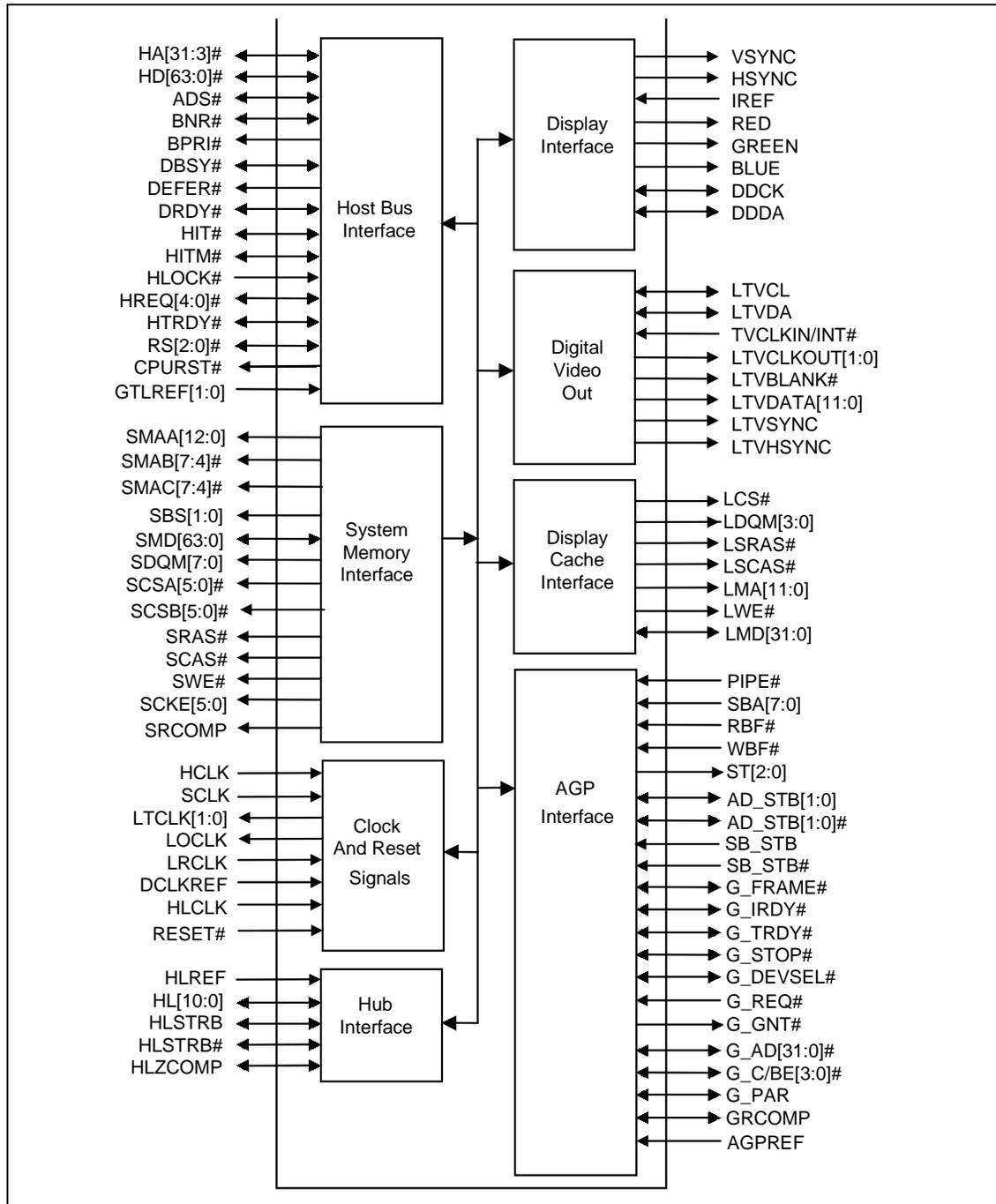

1. Overview

The Intel® 815 chipset family is a high-flexibility chipset designed to extend from the basic graphics/multimedia PC platform up to the mainstream performance desktop platform. The chipset consists of a 82815 Graphics and Memory Controller Hub (GMCH) and an I/O Controller Hub for the I/O subsystem. The GMCH integrates a system memory SDRAM controller that supports a 64-bit 100/133 MHz SDRAM array.

The 82815 GMCH integrates a Display Cache SDRAM controller that supports a 32-bit 133 MHz SDRAM array for enhanced integrated 2D and 3D graphics performance. Multiplexed with the display cache interface is an AGP controller interface to enable graphics configuration and upgrade flexibility with the Intel® 815 chipset family. The AGP interface and the internal graphics device are mutually exclusive. When the AGP port is populated with an AGP graphics card, the integrated graphics is disabled; thus, the display cache interface is not needed.

There are two chipsets in the Intel® 815 chipset family:

- Intel® 815 chipset: This chipset contains the 82815 GMCH and 82801AA ICH.
- Intel® 815E chipset. This chipset contains the 82815 GMCH and 82801BA ICH2.

Note: The only component difference between the Intel® 815 chipset and the Intel® 815E chipset is the I/O Controller Hub.

This datasheet provides an overview of the 815 chipset family (see Section 1.2). The remainder of the document describes the Intel® 82815 Graphics Memory Controller Hub (GMCH).

The Intel® 815 chipset family may contain design defects or errors known as errata which may cause the product to deviate from published specifications. Current characterized errata are available on request.

1.1. Related Documents

- AGTL+ I/O Specification: Contained in the Intel® Pentium® II Processor Databook
- *PCI Local bus Specification 2.2*: Contact www.pcisig.com
- *Intel® 82801AA (ICH) and Intel® 82801AB (ICH0) I/O Controller Hub Datasheet* (Document Number 290655)
- *Intel® 82801BA I/O Controller Hub (ICH2) Datasheet* (Document Number 290687)
- *Intel® 82802 Firmware Hub (FWH) Datasheet* (Document Number 290658)
- *Intel® 815 Chipset Design Guide* (Document Number 298233)
- *Intel® 815E Chipset Design Guide* (Document Number 298234)

1.2. The Intel® 815 Chipset Family

Figure 1 shows a typical system block diagram based on the Intel® 815 chipset family. The chipset uses a hub architecture with the GMCH as the host bridge hub and the I/O Controller Hub as the I/O hub. The GMCH supports processor bus frequencies of 66/100/133 MHz. The I/O Controller Hub is highly integrated providing many of the functions needed in today's PC platforms; it also provides the interface to the PCI Bus. The GMCH and I/O Controller Hub communicate over a dedicated hub interface.

82801AA ICH and 82801BA ICH2 functions include:

- PCI Rev 2.2 compliant with support for 33 MHz PCI operations
- Supports up to 6 Req/Gnt pairs (PCI Slots)
- Power management logic support
- Enhanced DMA controller, interrupt controller, and timer functions
- Integrated IDE controller
 - Ultra ATA/66/33 (ICH)
 - Ultra ATA/100/66/33 (ICH2)
- USB host interface
 - 1 host controller and supports 2 USB ports (ICH)
 - 2 host controllers and supports 4 USB ports (ICH2)
- Integrated LAN controller (ICH2 only)
- System Management Bus (SMBus) compatible with most I²C devices
 - ICH has bus master capability
 - ICH2 has both bus master and slave capability
- AC'97 2.1 compliant link for audio and telephony codecs
 - 2 channels (ICH)
 - Up to 6 channels (ICH2)
- Low Pin Count (LPC) interface
- Firmware Hub (FWH) interface support
 - Intel's FWH component is the 82802: It contains a Random Number Generator (RNG), five General Purpose Inputs (GPIs), register-based block locking, hardware-based locking, and Flash memory for platform code/data nonvolatile storage
 - FWH component is also available from other suppliers
- Alert on LAN*
 - AOL (ICH and ICH2)
 - AOL2 (ICH2 only)

Figure 1. Intel® 815 Chipset Family System Block Diagram

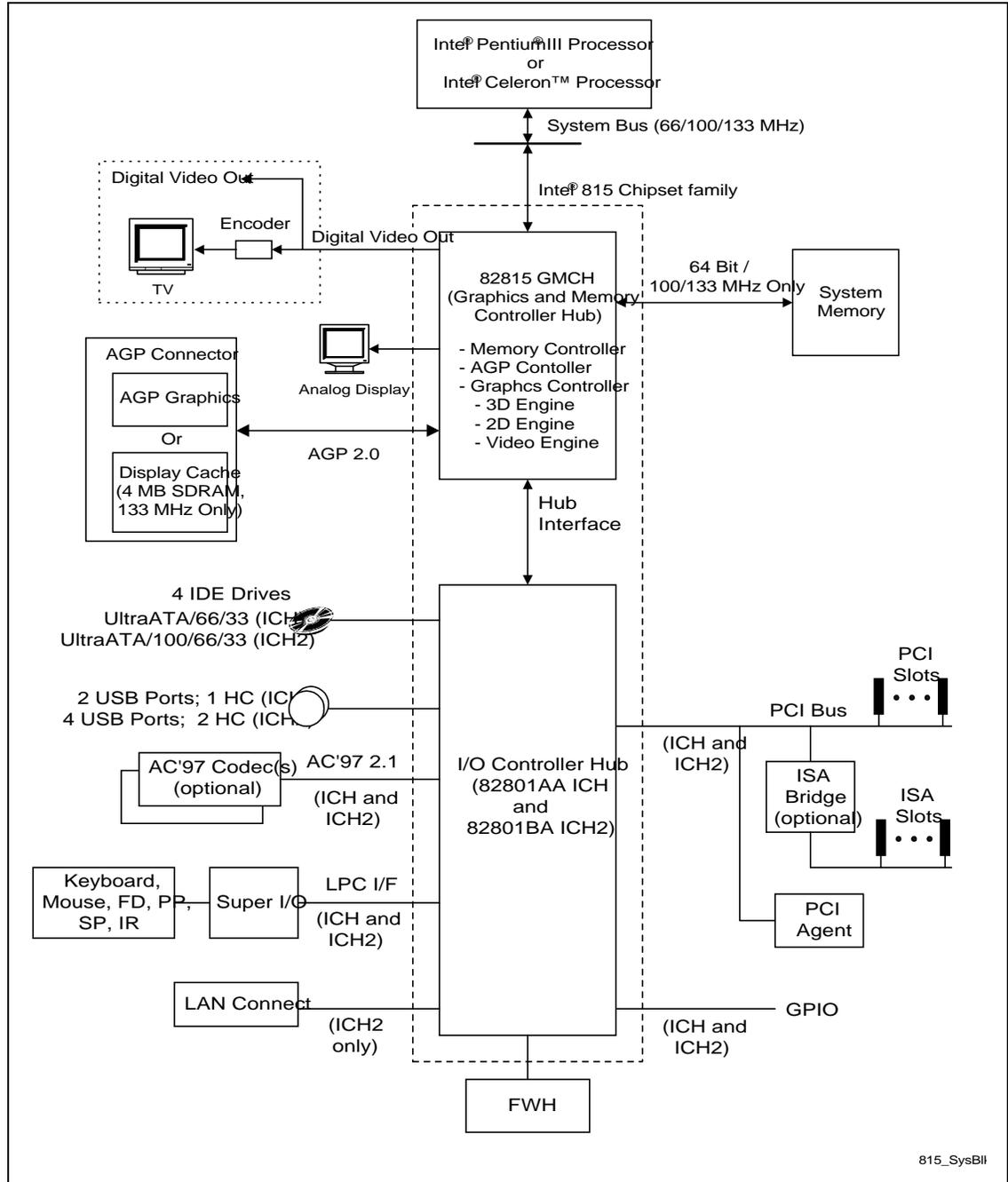

1.4. Host Interface

The host interface of the GMCH is optimized to support the Intel® Pentium® III processor and Intel® Celeron™ processor in the FC-PGA package. The GMCH implements the host address, control, and data bus interfaces within a single device. The GMCH supports a 4-deep in-order queue (i.e., supports pipelining of up to 4 outstanding transaction requests on the host bus). Host bus addresses are decoded by the GMCH for accesses to system memory, PCI memory and PCI I/O (via hub interface), PCI configuration space and Graphics memory. The GMCH takes advantage of the pipelined addressing capability of the processor to improve the overall system performance.

The 82815 GMCH supports the 370-pin socket processor.

- **370-pin socket** (PGA370). The PGA370 is a zero insertion force (ZIF) socket that a processor in the FC-PGA package will use to interface with a system board.

1.5. System Memory Interface

The GMCH integrates a system memory controller that supports a 64-bit 100/133 MHz SDRAM array. The only DRAM type supported is industry standard Synchronous DRAM (SDRAM). The SDRAM controller interface is fully configurable through a set of control registers.

The GMCH supports industry standard 64-bit wide DIMMs with SDRAM devices. The thirteen multiplexed address lines (SMAA[12:0]) along with the two bank select lines (SBS[1:0]) allow the GMCH to support 2M, 4M, 8M, 16M, and 32M x64 DIMMs. Only asymmetric addressing is supported. The GMCH has 6 SCS# lines (2 copies of each for electrical loading), enabling the support of up to six 64-bit rows of SDRAM. The GMCH targets SDRAM with CL2 and CL3, and supports both single and double-sided DIMMs. Additionally, the GMCH also provides a 1024 deep refresh queue. The GMCH can be configured to keep up to 4 pages open within the memory array. Pages can be kept open in any one bank of memory.

The Intel® 815 chipset family supports up to 3 DIMM connectors in a system. A maximum of 2 double-sided or 3 single-sided DIMMs may be populated when the SDRAM interface is operating at 133 MHz. Upon detection that additional rows are populated beyond these configurations, the BIOS must down-shift the SDRAM clocks to 100 MHz through a two-wire interface of the system clock generator.

SCKE[5:0] is used in configurations requiring powerdown mode for the SDRAM.

1.6. Multiplexed AGP and Display Cache Interface

The 82815 GMCH multiplexes an AGP interface with a display cache interface for internal 3D graphics performance improvement. The display cache is used only in the internal graphics. When an AGP card is installed in the system, the GMCH internal graphics will be disabled and the AGP controller will be enabled.

1.6.1. AGP Interface

A single AGP connector is supported by the GMCH AGP interface. The AGP buffers operate in one of two selectable modes in order to support the AGP Universal Connector:

- 3.3V drive, **not** 5 volt safe: This mode is compliant to the AGP 1.0 and 2.0 specifications.
- 1.5V drive, **not** 3.3 volt safe: This mode is compliant with the AGP 2.0 specification.

The following table shows the AGP Data Rate and the Signaling Levels supported by the GMCH.

Data Rate	Signaling Level	
	1.5V	3.3V
1x AGP	Yes	Yes
2x AGP	Yes	Yes
4x AGP	Yes	No

The AGP interface supports 4x AGP signaling. AGP semantic (PIPE# or SBA[7:0]) cycles to SDRAM are not snooped on the host bus. AGP FRAME# cycles to SDRAM are snooped on the host bus. The GMCH supports PIPE# or SBA[7:0] AGP address mechanisms, but not both simultaneously. Either the PIPE# or the SBA[7:0] mechanism must be selected during system initialization. High priority accesses are supported. Only memory writes from the hub interface to AGP are allowed. No transactions from AGP to the hub interface are allowed.

1.6.2. Display Cache Interface

The GMCH supports a Display Cache SDRAM controller with a 32-bit 133 MHz SDRAM array. The DRAM type supported is industry standard Synchronous DRAM (SDRAM) like that of the system memory. The local memory SDRAM controller interface is fully configurable through a set of control registers.

1.7. Hub Interface

The hub interface is a private interconnect between the GMCH and the I/O Controller Hub.

1.8. 82815 GMCH Integrated Graphics Support

The GMCH includes a highly integrated graphics accelerator. Its architecture consists of dedicated multi-media engines executing in parallel to deliver high performance 3D, 2D, and motion compensation video capabilities. The 3D and 2D engines are managed by a 3D/2D pipeline preprocessor allowing a sustained flow of graphics data to be rendered and displayed. The deeply pipelined 3D accelerator engine provides 3D graphics quality and performance via per-pixel 3D rendering and parallel data paths which allow each pipeline stage to simultaneously operate on different primitives or portions of the same primitive. The GMCH graphics accelerator engine supports perspective-correct texture mapping, trilinear and anisotropic Mip-Map filtering, Gouraud shading, alpha-blending, fogging and Z-buffering. A rich set of 3D instructions permit these features to be independently enabled or disabled.

For the GMCH, a Display Cache (DC) can be used for the Z-buffer (textures and display buffer(s) are located only in system memory). If the display cache is not used, the Z-buffer is located in system memory.

The GMCH integrated graphics accelerator's 2D capabilities include BLT and arithmetic STRBLT engines, a hardware cursor and an extensive set of 2D registers and instructions. The high performance 64-bit BitBLT engine provides hardware acceleration for many common Windows operations.

In addition to its 2D/3D capabilities, the GMCH integrated graphics accelerator also supports full MPEG-2 motion compensation for software-assisted DVD video playback, a VESA DDC2B compliant display interface and a digital video out port which may support (via an external video encoder) NTSC and PAL broadcast standards and (via an external TMDS transmitter) digital Flat Panel or Digital CRT displays.

1.8.1. Display, Digital Video Out, and LCD/Flat Panel/Digital CRT

The GMCH provides interfaces to a standard progressive scan monitor, TV-Out device, and TMDS transmitter. These interfaces are only active when running in internal graphics mode.

- The GMCH directly drives a standard progressive scan monitor up to a resolution of 1600x1200 pixels.
- The GMCH provides a Digital Video Out interface to connect an external device to drive a 1280x1024 resolution non-scalar DDP digital Flat Panel with appropriate EDID 1.2 data or digital CRTs. The interface has 1.8V signaling to allow it to operate at higher frequencies. This interface can also connect to a 1.8V TV-Out encoder.

1.9. System Clocking

The 82815 GMCH has a new type of clocking architecture. It has integrated SDRAM buffers that run at either 100 or 133 MHz, independent of the system bus frequency. See table below for supported system bus and system memory bus frequencies. The system bus frequency is selectable between 66 MHz, 100 MHz, or 133 MHz. The GMCH uses a copy of the USB clock as the DOT Clock input for the graphics pixel clock PLL.

Table 1. Supported System Bus and System Memory Bus Frequencies

Front Side Bus Frequency	System Memory Bus Frequency	Display Cache Interface Frequency
66 MHz	100 MHz	133 MHz or DVMT
100 MHz	100 MHz	133 MHz or DVMT
133 MHz	100 MHz	133 MHz or DVMT
133 MHz	133 MHz	133 MHz or DVMT

1.10. GMCH Power Delivery

The 82815 GMCH core voltage is 1.85V. System memory operates from a 3.3V supply. Display cache memory operates from the AGP 3.3V supply. AGP 1X/2X I/O can operate from either a 3.3V or a 1.5V supply. AGP 4X I/O requires a 1.5V supply. The AGP interface voltage is determined by the VDDQ generation on the motherboard.

2. Signal Description

This section provides a detailed description of the GMCH signals. The signals are arranged in functional groups according to their associated interface. The states of all of the signals during reset are provided in the System Reset section.

The “#” symbol at the end of a signal name indicates that the active, or asserted state occurs when the signal is at a low voltage level. When “#” is not present after the signal name the signal is asserted when at the high voltage level.

The following notations are used to describe the signal type:

I	Input pin
O	Output pin
I/OD	Input / Open Drain Output pin. This pin requires a pullup
I/O	Bi-directional Input/Output pin
s/t/s	Sustained Tristate. This pin is driven to its inactive state prior to tri-stating.
As/t/s	Active Sustained Tristate. This applies to some of the hub interface signals. This pin is weakly driven to its last driven value.

The signal description also includes the type of buffer used for the particular signal:

AGTL+	Open Drain AGTL+ interface signal. Refer to the AGTL+ I/O Specification for complete details
AGP	AGP interface signals. These signals can be programmed to be compatible with AGP 2.0 3.3V or 1.5V Signaling Environment DC and AC Specifications. In 3.3V mode the buffers are not 5V tolerant. In 1.5V mode the buffers are not 3.3V tolerant.
CMOS	The CMOS buffers are low voltage TTL compatible signals. These are 3.3V only.
LVTTL	Low Voltage TTL compatible signals. There are 3.3V only.
1.8V	1.8V signals for the digital video interface
Analog	Analog CRT Signals

Note that the processor address and data bus signals (Host Interface) are logically inverted signals (i.e., the actual values are inverted of what appears on the processor bus). This must be taken into account and the addresses and data bus signals must be inverted inside the GMCH. All processor control signals follow normal convention. A 0 indicates an active level (low voltage) if the signal is followed by a # symbol and a 1 indicates an active level (high voltage) if the signal has no # suffix.

2.1. Host Interface Signals

Signal Name	Type	Description
CPURST#	O AGTL+	CPU Reset. The GMCH asserts CPURST# while RESET# (PCIRST# from the I/O Controller Hub) is asserted and for approximately 1 ms after RESET# is deasserted. The GMCH also pulses CPURST# for approximately 1 ms when requested via a hub interface special cycle. The CPURST# allows the processor to begin execution in a known state.
HA[31:3]#	I/O AGTL+	Host Address Bus. HA[31:3]# connect to the processor address bus. During processor cycles, HA[31:3]# are inputs. The GMCH drives HA[31:3]# during snoop cycles on behalf of Primary PCI. Note that the address bus is inverted on the processor bus.
HD[63:0]#	I/O AGTL+	Host Data. These signals are connected to the processor data bus. Note that the data signals are inverted on the processor bus.
ADS#	I/O AGTL+	Address Strobe. The processor bus owner asserts ADS# to indicate the first of two cycles of a request phase.
BNR#	I/O AGTL+	Block Next Request. Used to block the current request bus owner from issuing a new request. This signal is used to dynamically control the processor bus pipeline depth.
BPRI#	O AGTL+	Priority Agent Bus Request. The GMCH is the only priority agent on the processor bus. It asserts this signal to obtain the ownership of the address bus. This signal has priority over symmetric bus requests and will cause the current symmetric owner to stop issuing new transactions unless the HLOCK# signal was asserted.
DBSY#	I/O AGTL+	Data Bus Busy. Used by the data bus owner to hold the data bus for transfers requiring more than one cycle.
DEFER#	O AGTL+	Defer. The GMCH will generate a deferred response as defined by the rules of the GMCH dynamic defer policy. The GMCH will also use the DEFER# signal to indicate a processor retry response.
DRDY#	I/O AGTL+	Data Ready. Asserted for each cycle that data is transferred.
HIT#	I/O AGTL+	Hit. Indicates that a caching agent holds an unmodified version of the requested line. Also driven in conjunction with HITM# by the target to extend the snoop window.
HITM#	I/O AGTL+	Hit Modified. Indicates that a caching agent holds a modified version of the requested line and that this agent assumes responsibility for providing the line. HITM# is also driven in conjunction with HIT# to extend the snoop window.
HLOCK#	I AGTL+	Host Lock. All processor bus cycles sampled with the assertion of HLOCK# and ADS#, until the negation of HLOCK# must be atomic (i.e., no hub interface or GMCH graphics snoopable access to SDRAM is allowed when HLOCK# is asserted by the processor).
HREQ[4:0]#	I/O AGTL+	Host Request Command. Asserted during both clocks of request phase. In the first clock, the signals define the transaction type to a level of detail that is sufficient to begin a snoop request. In the second clock, the signals carry additional information to define the complete transaction type. The transactions supported by the GMCH are defined in the Host Interface section of this document.
HTRDY#	I/O AGTL+	Host Target Ready. Indicates that the target of the processor transaction is able to enter the data transfer phase.

Signal Name	Type	Description
RS[2:0]#	I/O AGTL+	Response Signals. Indicates type of response as shown below: 000 = Idle state 001 = Retry response 010 = Deferred response 011 = Reserved (not driven by the GMCH) 100 = Hard Failure (not driven by the GMCH) 101 = No data response 110 = Implicit Writeback 111 = Normal data response
GTLREF[1:0]	I	GTL Reference. Reference voltage input for the Host GTL interface. GTLREF is $\frac{2}{3} * V_{TT}$. V_{TT} is nominally 1.5V.

2.2. System Memory Interface Signals

Signal Name	Type	Description
SMAA[12:0] SMAB[7:4]# SMAC[7:4]# SBS[1:0]	O CMOS	Memory Address. SMAA[12:0], SMAB[7:4]#, and SMAC[7:4]# are used to provide the multiplexed row and column address to SDRAM. SBS[1:0] provide the Bank Select.
SBS[1:0]	O CMOS	Memory Bank Select. These signals define the banks that are selected within each DRAM row. The SMAx and SBS signals combine to address every possible location within a DRAM device. SBS[1:0] may be heavily loaded and require 2 SDRAM clock cycles for setup time to the SDRAMs. For this reason, all chip select signals (SCSA[5:0]# and SCSB[5:0]#) must be deasserted on any SDRAM clock cycle that one of these signals change.
SMD[63:0]	I/O CMOS	Memory Data. These signals are used to interface to the SDRAM data bus.
SDQM[7:0]	O CMOS	Input/Output Data Mask. These pins act as synchronized output enables during read cycles and as a byte enables during write cycles.
SCSA[5:0]# SCSB[5:0]#	O CMOS	Chip Select. For the memory row configured with SDRAM, these pins perform the function of selecting the particular SDRAM components during the active state.
SRAS#	O CMOS	SDRAM Row Address Strobe. These signals drive the SDRAM array directly without any external buffers.
SCAS#	O CMOS	SDRAM Column Address Strobe. These signals drive the SDRAM array directly without any external buffers.
SWE#	O CMOS	Write Enable Signal. SWE# is asserted during writes to SDRAM.
SCKE[5:0]	O CMOS	System Memory Clock Enable. SCKE SDRAM Clock Enable is used to signal a self-refresh or power-down command to an SDRAM array when entering system suspend.
SRCOMP	O	System Memory RCOMP. Used to calibrate the System memory I/O buffers. This pin should be connected to a 40 ohm resistor tied to 3.3V VCC (VSUS3.3).

2.3. AGP Interface Signals

For more details on the operation of these signals, refer to the AGP Interface Specification Revision 2.0. Some of the AGP interface signals are multiplexed with Display Cache interface signals. AGP interface signals only function as documented in this section when the GMCH AGP interface is enabled (GMCH integrated graphics disabled). Refer to Section 2.11 for multiplexing map of AGP to Display Cache interface signals.

2.3.1. AGP Addressing Signals

There are two mechanisms that the AGP master can enqueue AGP requests: PIPE# and SBA (side-band addressing). Upon initialization, one of the methods is chosen. The master may not switch methods without a full reset of the system. When **PIPE#** is used to enqueue addresses, the master is not allowed to queue addresses using the SBA bus. For example, during configuration time, if the master indicates that it can use either mechanism, the configuration software will indicate which mechanism the master will use. Once this choice has been made, the master will continue to use the mechanism selected until the system is reset (and reprogrammed) to use the other mode. This change of modes is not a dynamic mechanism but rather a static decision when the device is first being configured after reset.

Signal Name	Type	Description
PIPE#	I AGP	<p>Pipeline.</p> <p>During PIPE# Operation. This signal is asserted by the AGP master to indicate a full-width address is to be enqueued on by the target using the AD bus. One address is placed in the AGP request queue on each rising clock edge while PIPE# is asserted.</p> <p>During SBA Operation. This signal is not used if SBA (Side Band Addressing) is selected.</p> <p>During FRAME# Operation. This signal is not used during AGP FRAME# operation.</p>
SBA[7:0]	I AGP	<p>Side-band Addressing.</p> <p>During PIPE# Operation. These signals are not used during PIPE# operation.</p> <p>During SBA Operation. These signals (the SBA, or side-band addressing, bus) are used by the AGP master (graphics component) to place addresses into the AGP request queue. The SBA bus and AD bus operate independently. That is, transactions can proceed on the SBA bus and the AD bus simultaneously.</p> <p>During FRAME# Operation. These signals are not used during AGP FRAME# operation.</p>

2.3.2. AGP Flow Control Signals

Signal Name	Type	Description
RBF#	I AGP	<p>Read Buffer Full.</p> <p>During PIPE# and SBA Operation. Read buffer full indicates if the master is ready to accept previously requested low priority read data. When RBF# is asserted the GMCH is not allowed to initiate the return low priority read data. That is, the GMCH can finish returning the data for the request currently being serviced, however it can not begin returning data for the next request. RBF# is only sampled at the beginning of a cycle.</p> <p>If the AGP master is always ready to accept return read data, then it is not required to implement this signal.</p> <p>During FRAME# Operation. This signal is not used during AGP FRAME# operation.</p>
WBF#	I AGP	<p>Write-Buffer Full.</p> <p>During PIPE# and SBA Operation. Write buffer full indicates if the master is ready to accept Fast Write data from the GMCH. When WBF# is asserted the GMCH is not allowed to drive Fast Write data to the AGP master. WBF# is only sampled at the beginning of a cycle.</p> <p>If the AGP master is always ready to accept fast write data, then it is not required to implement this signal.</p> <p>During FRAME# Operation: This signal is not used during AGP FRAME# operation.</p>

2.3.3. AGP Status Signals

Signal Name	Type	Description
ST[2:0]	O AGP	<p>Status Bus.</p> <p>During PIPE# and SBA Operation. Provides information from the arbiter to a AGP Master on what it may do. ST[2:0] only have meaning to the master when its GNT# is asserted. When GNT# is deasserted, these signals have no meaning and must be ignored. Refer to the AGP Interface Specificaiton revision 2.0 for further explanation of the ST[2:0] values and their meanings.</p> <p>During FRAME# Operation. These signals are not used during FRAME# based operation; except that a '111' indicates that the master may begin a FRAME# transaction.</p>

2.3.4. AGP Clcking Signals (Strobes)

Signal Name	Type	Description
AD_STB0	I/O s/t/s AGP	<p>AD Bus Strobe-0.</p> <p>During 2X Operation. During 2X operation, this signal provides timing for the G_AD[15:0] and G_C/BE[1:0]# signals. The agent that is providing the data will drive this signal.</p> <p>During 4X Operation. During 4X operation, this is one-half of a differential strobe pair that provides timing information for the G_AD[15:0] and G_C/BE[1:0]# signals.</p>
AD_STB0#	I/O s/t/s AGP	<p>AD Bus Strobe-0 Compliment.</p> <p>During 2X Operation. During 2X operation, this signal is not used.</p> <p>During 4X Operation. During 4X operation, this is one-half of a differential strobe pair that provides timing information for the G_AD[15:0] and G_C/BE[1:0]# signals. The agent that is providing the data will drive this signal.</p>
AD_STB1	I/O s/t/s AGP	<p>AD Bus Strobe-1.</p> <p>During 2X Operation. During 2X operation, this signal provides timing for the G_AD[16:31] and G_C/BE[2:3]# signals. The agent that is providing the data drives this signal.</p> <p>During 4X Operation. During 4X operation, this is one-half of a differential strobe pair that provides timing information for the G_AD[16:31] and G_C/BE[2:3]# signals. The agent that is providing the data drives this signal.</p>
AD_STB1#	I/O s/t/s AGP	<p>AD Bus Strobe-1 Compliment.</p> <p>During 2X Operation. During 2X operation, this signal is not used</p> <p>During 4X Operation. During 4X operation, this is one-half of a differential strobe pair that provides timing information for the G_AD[16:31] and G_C/BE[2:3]# signals. The agent that is providing the data drives this signal.</p>
SB_STB	I AGP	<p>SBA Bus Strobe.</p> <p>During 2X Operation. During 2X operation, this signal provides timing for the SBA bus signals. The agent that is driving the SBA bus drives this signal.</p> <p>During 4X Operation. During 4X operation, this is one-half of a differential strobe pair that provides timing information for the SBA bus signals. The agent that is driving the SBA bus drives this signal.</p>
SB_STB#	I AGP	<p>SBA Bus Strobe Compliment.</p> <p>During 2X Operation. During 2X operation, this signal is not used.</p> <p>During 4X Operation. During 4X operation, this is one-half of a differential strobe pair that provides timing information for the SBA bus signals. The agent that is driving the SBA bus drives this signal.</p>
GRCOMP	O	<p>AGP RCOMP. Used to calibrate AGP I/O buffers. This pin should be connected to a 40 ohm pull down resistor tied to VSS.</p>
AGPREF	I	<p>AGP Reference. Reference voltage input for the AGP interface. AGPREF should be $0.4 \cdot VDD_{AGP}$ when VDD is 3.3V, or $0.5 \cdot VDD_{AGP}$ when VDD is 1.5V.</p>

2.3.5. AGP FRAME# Signals

Signal Name	Type	Description
G_FRAME#	I/O s/t/s AGP	<p>FRAME.</p> <p>During PIPE# and SBA Operation. Not used by AGP SBA and PIPE#, but used during AGP FRAME# .</p> <p>During Fast Write Operation. G_FRAME# is used to frame transactions as an output from the GMCH during Fast Writes.</p> <p>During FRAME# Operation. G_FRAME# is an output when the GMCH acts as an initiator on the AGP Interface. G_FRAME# is asserted by the GMCH to indicate the beginning and duration of an access. G_FRAME# is an input when the GMCH acts as a FRAME# based AGP target. As a FRAME# based AGP target, the GMCH latches the G-C/BE[3:0]# and the G_AD[31:0] signals on the first clock edge on which it samples G_FRAME# active.</p>
G_IRDY#	I/O s/t/s AGP	<p>Initiator Ready.</p> <p>During PIPE# and SBA Operation. Not used while enqueueing requests via AGP SBA and PIPE#, but used during the data phase of PIPE# and SBA transactions.</p> <p>During FRAME# Operation. G_IRDY# is an output when GMCH acts as a FRAME# based AGP initiator and an input when the GMCH acts as a FRAME# based AGP target. The assertion of G_IRDY# indicates the current FRAME# based AGP bus initiator's ability to complete the current data phase of the transaction.</p> <p>During Fast Write Operation. G_IRDY# indicates the AGP compliant master is ready to provide all write data for the current transaction. Once G_IRDY# is asserted for a write operation, the master is not allowed to insert wait states. The master is never allowed to insert a wait state during the initial data transfer (32 bytes) of a write transaction. However, it may insert wait states after each 32 byte block is transferred.</p>
G_TRDY#	I/O s/t/s AGP	<p>Target Ready.</p> <p>During PIPE# and SBA Operation. Not used while enqueueing requests via AGP SBA and PIPE#, but used during the data phase of PIPE# and SBA transactions.</p> <p>During FRAME# Operation. G_TRDY# is an input when the GMCH acts as an AGP initiator and an output when the GMCH acts as a FRAME# based AGP target. The assertion of G_TRDY# indicates the target's ability to complete the current data phase of the transaction.</p> <p>During Fast Write Operation. G_TRDY# indicates the AGP compliant target is ready to receive write data for the entire transaction (when the transfer size is less than or equal to 32 bytes) or is ready to transfer the initial or subsequent block (32 bytes) of data when the transfer size is greater than 32 bytes. The target is allowed to insert wait states after each block (32 bytes) is transferred on write transactions.</p>
G_STOP#	I/O s/t/s AGP	<p>Stop.</p> <p>During PIPE# and SBA Operation. This signal is not used during PIPE# or SBA operation.</p> <p>During FRAME# Operation. STOP# is an input when the GMCH acts as a FRAME# based AGP initiator and an output when the GMCH acts as a FRAME# based AGP target. STOP# is used for disconnect, retry, and abort sequences on the AGP interface.</p>

Signal Name	Type	Description
G_DEVSEL#	I/O s/t/s AGP	<p>Device Select.</p> <p>During PIPE# and SBA Operation. This signal is not used during PIPE# or SBA operation.</p> <p>During FRAME# Operation. G_DEVSEL#, when asserted, indicates that a FRAME# based AGP target device has decoded its address as the target of the current access. The GMCH asserts G_DEVSEL# based on the SDRAM address range being accessed by a PCI initiator. As an input it indicates whether any device on the bus has been selected.</p>
G_REQ#	I AGP	<p>Request.</p> <p>During SBA Operation. This signal is not used during SBA operation.</p> <p>During PIPE# and FRAME# Operation. G_REQ#, when asserted, indicates that a FRAME# or PIPE# based AGP master is requesting use of the AGP interface. This signal is an input into the GMCH.</p>
G_GNT#	O AGP	<p>Grant.</p> <p>During SBA, PIPE# and FRAME# Operation. G_GNT# along with the information on the ST[2:0] signals (status bus) indicates how the AGP interface will be used next. Refer to the AGP Interface Specification revision 2.0 for further explanation of the ST[2:0] values and their meanings.</p>
G_AD[31:0]	I/O AGP	<p>Address/Data Bus.</p> <p>During PIPE# and FRAME# Operation. G_AD[31:0] are used to transfer both address and data information on the AGP interface.</p> <p>During SBA Operation. G_AD[31:0] are used to transfer data on the AGP interface.</p>
G_C/BE[3:0]#	I/O AGP	<p>Command/Byte Enable.</p> <p>During FRAME# Operation. During the address phase of a transaction, G_C/BE[3:0]# define the bus command. During the data phase G_C/BE[3:0]# are used as byte enables. The byte enables determine which byte lanes carry meaningful data. The commands issued on the G_C/BE# signals during FRAME# based AGP are the same G_C/BE# command described in the PCI 2.1 and 2.2 specifications.</p> <p>During PIPE# Operation. When an address is enqueued using PIPE#, the C/BE# signals carry command information. Refer to the AGP 2.0 Interface Specification Revision 2.0 for the definition of these commands. The command encoding used during PIPE# based AGP is Different than the command encoding used during FRAME# based AGP cycles (or standard PCI cycles on a PCI bus).</p> <p>During SBA Operation. These signals are not used during SBA operation.</p>
G_PAR	I/O AGP	<p>Parity.</p> <p>During FRAME# Operation. G_PAR is driven by the GMCH when it acts as a FRAME# based AGP initiator during address and data phases for a write cycle, and during the address phase for a read cycle. G_PAR is driven by the GMCH when it acts as a FRAME# based AGP target during each data phase of a FRAME# based AGP memory read cycle. Even parity is generated across G_AD[31:0] and G_C/BE[3:0]#.</p> <p>During SBA and PIPE# Operation. This signal is not used during SBA and PIPE# operation.</p>

NOTES:

1. LOCK#, SERR#, and PERR# signals are not supported on the AGP Interface (even for PCI operations).
2. PCI signals described in this table behave according to PCI 2.1 specifications when used to perform PCI transactions on the AGP interface.

2.4. Display Cache Interface Signals

Some of the Display Cache interface signals are multiplexed with AGP interface signals. Display Cache interface signals only function as documented in this section when the GMCH integrated graphics is enabled (GMCH AGP interface disabled). Refer to Section 2.11 for multiplexing map of AGP to Display Cache interface signals.

Signal Name	Type	Description
LCS#	O CMOS	Chip Select. For the memory row configured with SDRAM, this pin performs the function of selecting the particular SDRAM components during the active state.
LDQM[3:0]	O AGP	Input/Output Data Mask. These pins control the memory array and act as synchronized output enables during read cycles and as a byte enables during write cycles.
LRAS#	O CMOS	SDRAM Row Address Strobe. The LRAS# signal is used to generate SDRAM Command encoded on LRAS#/LCAS#/LWE# signals. When LRAS# is sampled active at the rising edge of the SDRAM clock, the row address is latched into the SDRAMs.
LCAS#	O CMOS	SDRAM Column Address Strobe. The LSCAS# signal is used to generate SDRAM Command encoded on LSRAS#/LSCAS#/LWE# signals. When LSCAS# is sampled active at the rising edge of the SDRAM clock, the column address is latched into the SDRAMs.
LMA[11:0]	O AGP	Memory Address. LMA[11:0] are used to provide the multiplexed row and column address to SDRAM.
LWE#	O CMOS	Write Enable Signal. LWE# is asserted during writes to SDRAM.
LMD[31:0]	I/O AGP	Memory Data. These signals are used to interface to the SDRAM data bus of SDRAM array.
L_FSEL	I CMOS	<p>Display Cache Frequency Select. This signal indicates whether the display cache operates at 100 MHz or 133 MHz. The value of this pin is sampled at deassertion of CPURST# to determine display cache frequency.</p> <p>HIGH = 133 MHz (Default) LOW = 100 MHz</p> <p>Note: L_FSEL has a weak internal pull-up enabled during reset.</p> <p>Note: 100 MHz display cache is a non-validated feature and should be implemented only if OEM performs validation specifically on this feature.</p>

2.5. Hub Interface Signals

Signal Name	Type	Description
HL[10:0]	I/O	Hub Interface Signals. Signals used for the hub interface.
HLSTRB	I/O	Packet Strobe. One of two differential strobe signals used to transmit or receive packet data.
HLSTRB#	I/O	Packet Strobe Complement. One of two differential strobe signals used to transmit or receive packet data.
HCOMP	I/O	Hub Compensation Pad. Used to calibrate the hub interface buffers. This pin should be connected to a 40 ohm resistor tied to 1.8V VCC (VSUS_1.8)
HLREF	I Ref	HUB Reference. Sets the differential voltage reference for the hub interface.

2.6. Display Interface Signals

Signal Name	Type	Description
VSYNC	O 3.3V	CRT Vertical Synchronization. This signal is used as the vertical sync (polarity is programmable) or "Vsync Interval".
HSYNC	O 3.3V	CRT Horizontal Synchronization. This signal is used as the horizontal sync (polarity is programmable) or "Hsync Interval".
IWASTE	I Ref	Waste Reference. This signal must be tied to ground.
IREF	I Ref	I Reference. Set pointer resistor for the internal color palette DAC.
RED	O Analog	CRT Analog Video Output from the internal color palette DAC. The DAC is designed for a 37.5 ohm equivalent load on each pin (e.g., 75 ohm resistor on the board, in parallel with the 75 ohm CRT load)
GREEN	O Analog	CRT Analog video output from the internal color palette DAC. The DAC is designed for a 37.5 ohm equivalent load on each pin (e.g., 75 ohm resistor on the board, in parallel with the 75 ohm CRT load)
BLUE	O Analog	CRT Analog video output from the internal color palette DAC. The DAC is designed for a 37.5 ohm equivalent load on each pin (e.g., 75 ohm resistor on the board, in parallel with the 75 ohm CRT load)
DDCK	I/O CMOS	CRT Monitor DDC Interface Clock. (Also referred to as VESA™ "Display Data Channel", also referred to as the "Monitor Plug-n-Play" interface.) For DDC1, DDCK and DDDA provide a unidirectional channel for Extended Display ID. For DDC2, DDCK and DDDA can be used to establish a bi-directional channel based on I ² C protocol. The host can request Extended Display ID or Video Display Interface information over the DDC2 channel.
DDDA	I/O CMOS	CRT Monitor DDC Interface Data. See DDCK Description

2.7. Digital Video Output Signals/TV-Out Pins

Signal Name	Type	Description
TVCLKIN/INT#	I 1.8V	<p>Low Voltage TV Clock In (TV-Out Mode). In 1.8V TV-Out usage, the TVCLKIN pin functions as a pixel clock input to the GMCH from the TV encoder. The TVCLKIN frequency ranges from 20 MHz to 40 MHz depending on the mode (e.g., NTSC or PAL) and the overscan compensation values in the TV Encoder. CLKIN has a worse case duty cycle of 60%/40% coming in to the GMCH.</p> <p>Flat Panel Interrupt (LCD Mode). In Flat Panel usage, the INT# pin is asserted to cause an interrupt (typically, to indicate a hot plug or unplug of a flat panel). In Flat Panel usage, this pin is connected internally to a pull-up resistor.</p>
LTVCLKOUT[1:0]	O 1.8V	<p>LCD/TV Port Clock Out: These pins provide a differential pair reference clock that can run up to 85 MHz.</p> <p>Note: It is always recommended that these pins be used as a differential pair. Devices running at frequencies less than 65 MHz can operate in single-ended clock mode and use LTVCLKOUT[0] as the clock. When operating in single-ended clock mode, LTVCLKOUT[1] is not used.</p>
LTVBLANK#	O 1.8V	<p>Flicker Blank or Border Period Indication. BLANK# is a programmable output pin driven by the graphics control. When programmed as a blank period indication, this pin indicates active pixels excluding the border. When programmed as a border period indication, this pin indicates active pixel including the border pixels.</p>
LTVDATA[11:0]	O 1.8V	<p>LCD/TV Data. These signals are used to interface to the LCD/TV-Out data bus.</p>
LTVVSYNC	O 1.8V	<p>Vertical Sync. VSYNC signal for the LTV interface. The active polarity of the signal is programmable.</p>
LTVHSYNC	O 1.8V	<p>Horizontal Sync. HSYNC signal for the LTV interface. The active polarity of the signal is programmable.</p>
LTVCK	I/OD CMOS	<p>LCD/TV Clock. Clock pin for 2-wire interface.</p>
LTVDA	I/OD CMOS	<p>LCD/TV Data. Data pin for 2-wire interface.</p>

2.8. Power Signals

Signal Name	Type	Description
V1.8	Power	Core Power (1.85V)
VDDQ	Power	AGP I/O and Display Cache Buffer Supply Power
VSUS3.3	Power	System Memory Buffer Power (Separate 3.3V power plane for power down modes)
VCCDA	Power	Display Power Signal (Connect to an isolated 1.85V plane with VCCDACA1 and VCCDACA2)
VCCDACA1	Power	Display Power Signal
VCCBA	Power	AGP/Hub I/F Power (1.85V)
VCCDACA2	Power	Display Power Signal
VCCDLL	Power	System Memory PLL Power (1.85V)
VSSDA	Power	Display Ground Signal
VSSDACA	Power	Display Ground Signal
VSS	Power	Core Ground
VSSDLL	Power	System Memory PLL Ground
VSSBA	Power	AGP/Hub I/F Ground

2.9. Clock Signals

Signal Name	Type	Description
HCLK	I CMOS	Host Clock Input. Clock used on the host interface. Externally generated 66/100/133 MHz clock.
SCLK	I CMOS	System Memory Clock. Clock used on the output buffers of system memory. Externally generated 100/133 MHz clock.
LTCLK[1:0]	O CMOS	Display Cache Transmit Clocks. LTCLK[1:0] are internally generated display cache clocks used to clock the input buffers of the SDRAM devices.
LOCLK	O CMOS	Output Clock. LOCLK is an internally generated clock used to drive LRCLK.
LRCLK	I CMOS	Receive Clock. LRCLK is a display cache clock used to clock the input buffers of the GMCH.
DCLKREF	I CMOS	Display Interface Clock. DCLKREF is a 48 MHz clock generated by an external clock synthesizer to the GMCH.
HLCLK	I CMOS	Hub Interface Clock. 66 MHz hub interface clock generated by an external clock synthesizer.
RESET#	I	Global Reset. Driven by the I/O Controller Hub when PCIRST# is active.

2.10. GMCH Power-Up/Reset Strap Options

Pin Name	Strap Description	Configuration	Interface Type	Buffer Type
SBA[7]	Local Memory Frequency Select	High = 133 MHz (default) Low = 100MHz	AGP/LM	Input
SCAS#	Host Frequency	High = 133 MHz (default) Low = 100 or 66 MHz	System Memory	Bi-directional
SWE#	Host Frequency	High = 100 MHz (default) Low = 66 MHz	System Memory	Bi-directional
SMAA[11]	IOQ Depth	High = 4 (default) Low = 1	System Memory	Bi-directional
SMAA[10]	ALL Z	High = Normal (default) Low = All Z	System Memory	Bi-directional
SRAS#	XOR Test mode	High = Normal (default) Low = XOR test mode	System Memory	Bi-directional
SMAA[9]	FSB P-MOS Kicker Enable	High = enabled (non-CuMine) (default) Low = disabled (CuMine)	System Memory	Bi-directional

NOTES:

1. For normal operation, all strap pins must be set high "1" (except IOQ Depth and Host Frequency straps which should be set appropriately).
2. External reset signal used to sample the straps is RESET#.
3. All system memory reset straps have internal 50K ohm pull-ups during reset.

2.11. Multiplexed Display Cache and AGP Signal Mapping

Local Memory Signal Name	AGP Signal Name
LCAS#	G_AD26
LCS#	G_STOP#
LDQM0	G_AD0
LDQM1	G_AD10
LDQM2	SBA2
LDQM3	ST1
L_FSEL	SBA7
LMA0	G_AD22
LMA1	G_AD15
LMA10	G_FRAME#
LMA11/LBA	G_AD18
LMA2	G_AD11
LMA3	G_BE0#
LMA4	G_AD9
LMA5	G_AD13
LMA6	G_PAR
LMA7	G_TRDY#
LMA8	G_AD16
LMA9	G_AD20
LMD0	G_AD8
LMD1	G_AD7
LMD10	G_C/BE1#
LMD11	G_DEVSEL#
LMD12	G_IRDY#
LMD13	G_C/BE2#
LMD14	G_AD17
LMD15	G_AD19
LMD16	G_AD21
LMD17	G_AD23
LMD18	G_AD25
LMD19	G_AD27
LMD2	G_AD5
LMD20	G_AD29

Local Memory Signal Name	AGP Signal Name
LMD21	G_AD31
LMD22	SBA6
LMD23	SBA4
LMD24	PIPE#
LMD25	SBA1
LMD26	SBA3
LMD27	G_REQ#
LMD28	ST0
LMD29	ST2
LMD3	G_AD3
LMD30	RBF#
LMD31	SBA0
LMD4	G_AD1
LMD5	G_AD6
LMD6	G_AD4
LMD7	G_AD2
LMD8	G_AD12
LMD9	G_AD14
LRAS#	G_C/BE3#
LTCLK0	G_AD30
LTCLK1	G_AD28
LWE#	SBA5

2.11.1. Display Cache Mapping at the AGP Connector

The pin mapping assignments were made with the primary goal of optimizing the layout of the AIMM card (Display Cache add-in card that fits in the AGP connector). This was done based on the AGP signals as they exist on the standard AGP connector. Care was taken to avoid special types of AGP signals such as the strobes and any open-drain signals. Some signals that exist on the AGP connector that do not exist on the GMCH's AGP interface could not be used for Display Cache signals.

Pin #	B	Display Cache Signal	A	Display Cache Signal
1	OVRcnt#		12V	
2	5.0V		TYPEDET#	
3	5.0V		Reserved	
4	USB+		USB-	
5	GND		GND	
6	INTB#		INTA#	
7	CLK		RST#	
8	REQ# LGM_OK	LMD27	GNT#	
9	VCC3.3		VCC3.3	
10	ST0 LGM_OK	LMD28	ST1 LGM_OK	LDQM3
11	ST2 LGM_OK	LMD29	Reserved	
12	RBF# LGM_OK	LMD30	PIPE# LGM_OK	LMD24
13	GND		GND	
14	Reserved		WBF#	
15	SBA0 LGM_OK	LMD31	SBA1 LGM_OK	LMD25
16	VCC3.3		VCC3.3	
17	SBA2 LGM_OK	LDQM2	SBA3 LGM_OK	LMD26
18	SB_STB		SB_STB#	
19	GND		GND	
20	SBA4 LGM_OK	LMD23	SBA5 LGM_OK	LWE#
21	SBA6 LGM_OK	LMD22	SBA7 LGM_OK	L_FSEL
22	Reserved		Reserved	
23	GND		GND	
24	3.3Vaux		Reserved	
25	VCC3.3		VCC3.3	
26	AD31 LGM_OK	LMD21	AD30 LGM_OK	LTCLK0
27	AD29 LGM_OK	LMD20	AD28 LGM_OK	LTCLK1
28	VCC3.3		VCC3.3	
29	AD27 LGM_OK	LMD19	AD26 LGM_OK	LCAS#
30	AD25 LGM_OK	LMD18	AD24 LGM_OK	LCKE
31	GND		GND	

Pin #	B	Display Cache Signal	A	Display Cache Signal
32	AD_STB1	—	AD_STB1#	—
33	AD23 LGM_OK	LMD17	C/BE3# LGM_OK	LRAS#
34	Vddq	—	Vddq	—
35	AD21 LGM_OK	LMD16	AD22 LGM_OK	LMA0
36	AD19 LGM_OK	LMD15	AD20 LGM_OK	LMA9
37	GND	—	GND	—
38	AD17 LGM_OK	LMD14	AD18 LGM_OK	LMA11
39	C/BE2# LGM_OK	LMD13	AD16 LGM_OK	LMA8
40	Vddq	—	Vddq	—
41	IRDY# LGM_OK	LMD12	FRAME# LGM_OK	LMA10
42	3.3Vaux	—	Reserved	—
43	GND	—	GND	—
44	Reserved	—	Reserved	—
45	VCC3.3	—	VCC3.3	—
46	DEVSEL# LGM_OK	LMD11	TRDY# LGM_OK	LMA7
47	Vddq	—	STOP# LGM_OK	LCS#
48	PERR#	—	PME#	—
49	GND	—	GND	—
50	SERR#	—	PAR LGM_OK	LMA6
51	C/BE1# LGM_OK	LMD10	AD15 LGM_OK	LMA1
52	Vddq	—	Vddq	—
53	AD14 LGM_OK	LMD9	AD13 LGM_OK	LMA5
54	AD12 LGM_OK	LMD8	AD11 LGM_OK	LMA2
55	GND	—	GND	—
56	AD10 LGM_OK	LDQM1	AD9 LGM_OK	LMA4
57	AD8 LGM_OK	LMD0	C/BE0# LGM_OK	LMA3
58	Vddq	—	Vddq	—
59	AD_STB0	—	AD_STB0#	—
60	AD7 LGM_OK	LMD1	AD6 LGM_OK	LMD5
61	GND	—	GND	—
62	AD5 LGM_OK	LMD2	AD4 LGM_OK	LMD6
63	AD3 LGM_OK	LMD3	AD2 LGM_OK	LMD7
64	Vddq	—	Vddq	—
65	AD1 LGM_OK	LMD4	AD0 LGM_OK	LDQM0
66	Vrefcg	—	Vrefcg	—

3. Configuration Registers

This chapter describes the following register sets:

- **PCI Configuration Registers.** The GMCH contains PCI configuration registers for Device 0 (Host-hub interface Bridge/DRAM Controller), Device 1 (AGP Bridge), and Device 2 (GMCH internal graphics device).
- **Display Cache Interface Registers.** This register set is used for configuration of the Display Cache (DC) interface. The registers are located in memory space. The memory space addresses listed are offsets from the base memory address programmed into the MMADR register (Device 2, PCI configuration offset 14h).
- **Display Cache Detect and Diagnostic Registers.** This register set can be used for DC memory detection and testing. These registers are accessed via either I/O space or memory space. The memory space addresses listed are offsets from the base memory address programmed into the MMADR register (Device 1, PCI configuration offset 14h).

Note that the GMCH also contains an extensive set of registers and instructions for controlling its graphics operations. Intel graphics drivers provide the software interface at this architectural level. The register/instruction interface is transparent at the Application Programmers Interface (API) level and thus, beyond the scope of this document.

3.1. Register Nomenclature and Access Attributes

Mnemonic	Description
RO	Read-Only. If a register is read-only, writes to this register have no effect.
R/W	Read/Write. A register with this attribute can be read and written
R/WC	Read/Write Clear. A register bit with this attribute can be read and written. However, a write of a 1 clears (sets to 0) the corresponding bit and a write of a 0 has no effect.
R/WO	Read/Write-Once. A register bit with this attribute can be written to only once after power up. After the first write, the bit becomes read-only.
Reserved Bits	Some of the GMCH registers described in this section contain reserved bits. These bits are labeled "Reserved" or "Intel Reserved". Software must deal correctly with fields that are reserved. On reads, software must use appropriate masks to extract the defined bits and not rely on reserved bits being any particular value. On writes, software must ensure that the values of reserved bit positions are preserved. That is, the values of reserved bit positions must first be read, merged with the new values for other bit positions and then written back. Note that software does not need to perform read, merge, write operation for the configuration address register.
Reserved Registers	In addition to reserved bits within a register, the GMCH contains address locations in the configuration space of the Host-hub interface Bridge/DRAM Controller and the internal graphics device entities that are marked either "Reserved" or Intel Reserved". When a "Reserved" register location is read, a random value can be returned. ("Reserved" registers can be 8-, 16-, or 32-bit in size). Registers that are marked as "Reserved" must not be modified by system software. Writes to "Reserved" registers may cause system failure.
Default Value Upon Reset	Upon a Full Reset, the GMCH sets all of its internal configuration registers to predetermined default states. Some register values at reset are determined by external strapping options. The default state represents the minimum functionality feature set required to successfully bring up the system. Hence, it does not represent the optimal system configuration. It is the responsibility of the system initialization software (usually BIOS) to properly determine the DRAM configurations, operating parameters, and optional system features that are applicable, and to program the GMCH registers accordingly.

3.2. PCI Configuration Space Access

The GMCH and the I/O Controller Hub are physically connected via the hub interface. From a configuration standpoint, the hub interface connecting the GMCH and the I/O Controller Hub is **logically PCI bus #0**. All devices internal to the GMCH and I/O Controller Hub appear to be on PCI bus #0. The system primary PCI expansion bus is physically attached to the I/O Controller Hub and, from a configuration standpoint, appears as a hierarchical PCI bus behind a PCI-to-PCI bridge. The primary PCI expansion bus connected to the I/O Controller Hub has a programmable PCI Bus number.

Note: Even though the primary PCI expansion bus is referred to as PCI0 in this document it is not PCI bus #0 from a configuration standpoint.

The GMCH contains three PCI devices within a single physical component. The configuration registers for Devices 0, 1, and 2 are mapped as devices residing on PCI bus #0.

- Device 0: Host-hub interface Bridge/DRAM Controller. Logically this appears as a PCI device residing on PCI bus #0. Physically, Device 0 contains the PCI registers, DRAM registers, and other GMCH specific registers.
- Device 1: AGP Bridge supporting 1X/2X/4X transactions. Logically this appears as a PCI device residing on PCI bus #0.
- Device 2: GMCH internal graphics device. These registers contain the PCI registers for the GMCH internal graphics device. Logically this appears as a PCI device residing on PCI bus #0.

Note: A physical PCI bus #0 does not exist. The hub interface and the internal devices in the GMCH and I/O Controller Hub logically constitute PCI Bus #0 to configuration software.

3.2.1. PCI Bus Configuration Mechanism

The PCI Bus defines a slot based “configuration space” that allows each device to contain up to 8 functions with each function containing up to 256 8-bit configuration registers. The PCI specification defines two bus cycles to access the PCI configuration space: Configuration Read and Configuration Write. Memory and I/O spaces are supported directly by the processor. Configuration space is supported by a mapping mechanism implemented within the GMCH. The PCI specification defines two mechanisms to access configuration space, Mechanism #1 and Mechanism #2.

The GMCH supports only Mechanism #1

The configuration access mechanism makes use of the CONF_ADDR Register and CONF_DATA Register. To reference a configuration register a DWord I/O write cycle is used to place a value into CONF_ADDR that specifies the PCI bus, the device on that bus, the function within the device, and a specific configuration register of the device function being accessed. CONF_ADDR[31] must be 1 to enable a configuration cycle. CONF_DATA then becomes a window into the four bytes of configuration space specified by the contents of CONF_ADDR. Any read or write to CONF_DATA results in the GMCH translating the CONF_ADDR into the appropriate configuration cycle.

The GMCH is responsible for translating and routing the processor I/O accesses to the CONF_ADDR and CONF_DATA registers to internal GMCH configuration registers, the internal graphic device, or the hub interface.

3.2.2. Logical PCI Bus #0 Configuration Mechanism

The GMCH decodes the Bus Number (bits 23:16) and the Device Number fields of the CONF_ADDR register. If the Bus Number field of CONF_ADDR is 0, the configuration cycle is targeting a PCI Bus #0 device.

- Device #0: The Host-hub interface Bridge/DRAM Controller entity within the GMCH is hardwired as Device #0 on PCI Bus #0.
- Device #1: The AGP interface entity within the GMCH is hardwired as Device #1 on PCI Bus #0.
- Device #2: The internal graphics device entity within the GMCH is hardwired as Device #1 on PCI Bus #0.

Note: Configuration cycles to one of the GMCH internal devices are confined to the GMCH and not sent over the hub interface. Note that accesses to devices #3 to #31 on PCI Bus #0 are forwarded over the hub interface.

3.2.3. Primary PCI (PCI0) and Downstream Configuration Mechanism

If the Bus Number in the CONF_ADDR is non-zero, the GMCH generates a configuration cycle over the hub interface. The I/O Controller Hub compares the non-zero Bus Number with the Secondary Bus Number and Subordinate Bus Number registers of its P2P bridges to determine if the configuration cycle is meant for Primary PCI expansion bus (PCI0), or a downstream PCI bus.

3.2.4. Internal Graphics Device Configuration Mechanism

From the chipset configuration perspective, the internal graphics device is seen as a PCI device (device 2) on PCI Bus #0. Configuration cycles that target device 2 on PCI Bus #0 are claimed by the internal graphics device and are not forwarded via hub interface to the I/O Controller Hub.

3.2.5. GMCH Register Introduction

The GMCH contains two sets of software accessible registers, accessed via the Host I/O address space:

- Control registers I/O mapped into the host I/O space that control access to PCI configuration space (see section entitled I/O Mapped Registers)
- Internal configuration registers residing within the GMCH are partitioned into three logical device register sets (“logical” since they reside within a single physical device). The first register set is dedicated to Host-hub interface Bridge/DRAM Controller functionality (controls PCI bus 0 such as DRAM configuration, other chip-set operating parameters, and optional features). The second register block is dedicated to the AGP interface and the third block is dedicated to the internal graphics device in the GMCH.

The GMCH supports PCI configuration space accesses using the mechanism denoted as Configuration Mechanism #1 in the PCI specification.

The GMCH internal registers (both I/O Mapped and Configuration registers) are accessible by the host. The registers can be accessed as Byte, Word (16-bit), or DWord (32-bit) quantities, with the exception of CONF_ADDR which can only be accessed as a DWord. All multi-byte numeric fields use “little-endian” ordering (i.e., lower addresses contain the least significant parts of the field).

3.3. I/O Mapped Registers

The GMCH contains two registers that reside in the processor I/O address space – the Configuration Address (CONF_ADDR) Register and the Configuration Data (CONF_DATA) Register. The Configuration Address Register enables/disables the configuration space and determines what portion of configuration space is visible through the Configuration Data window.

3.3.1. CONF_ADDR—Configuration Address Register

I/O Address: 0CF8h Accessed as a DWord
 Default Value: 00000000h
 Access: Read/Write
 Size: 32 bits

CONF_ADDR is a 32 bit register accessed only when referenced as a DWord. A Byte or Word reference will “pass through” the Configuration Address Register onto the PCI0 bus as an I/O cycle. The CONF_ADDR register contains the Bus Number, Device Number, Function Number, and Register Number for which a subsequent configuration access is intended.

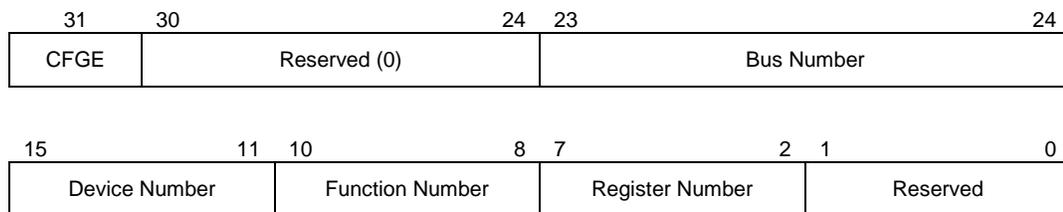

Bit	Descriptions
31	<p>Configuration Enable (CFGE). This bit enables/disables accesses to PCI configuration space.</p> <p>1 = Enabled.</p> <p>0 = Disable.</p>
30:24	Reserved. These bits are read-only and have a value of 0.
23:16	<p>Bus Number. When the Bus Number is programmed to 00h the target of the Configuration Cycle is one of the three devices in the GMCH or the PCI Bus (the hub interface is logically a PCI bus) that is directly connected to the GMCH, depending on the Device Number field.</p> <p>A type 0 Configuration Cycle is generated on the hub interface if the Bus Number is programmed to 00h and the GMCH is not the target.</p> <p>If the Bus Number is non-zero and matches the value programmed into the Secondary Bus Number Register a Type 0 PCI configuration cycle will be generated on the AGP bridge.</p> <p>If the Bus Number is non-zero, greater than the value in the Secondary Bus Number Register (Device 1) and less than or equal to the value programmed into the Subordinate Bus Number Register (Device 1) a Type 1 PCI configuration cycle will be generated on the AGP bridge.</p> <p>If the Bus Number is non-zero, and is less than the value programmed into the Secondary Bus Number Register or is greater than the value programmed into the Subordinate Bus Number Register a Type 1 hub interface configuration cycle is generated.</p>

Bit	Descriptions
15:11	<p>Device Number. This field selects one agent on the PCI bus selected by the Bus Number. During a Type 1 Configuration cycle, this field is mapped to AD[15:11]. During a Type 0 Configuration Cycle, this field is decoded and one bit among AD[31:11] is driven to a 1.</p> <p>The GMCH is always Device Number 0 for the Host bridge (GMCH) entity, Device Number 1 for the AGP bridge entity, and Device Number 2 for the Internal Graphics Device entity.</p> <p>If the Bus Number is non-zero and matches the value programmed into the Secondary Bus Number Register, a Type 0 PCI configuration cycle is generated on the AGP bridge. The Device Number field is decoded and the GMCH asserts one and only one GADxx signal as an IDSEL. GAD16 is asserted to access Device 0, GAD17 for Device 1, GAD18 for Device 2 and so forth up to Device 15 which asserts AD31. All device numbers higher than 15 cause a type 0 configuration access with no IDSEL asserted, which results in a Master Abort reported in the GMCH's "virtual" PCI-PCI bridge registers.</p> <p>For Bus Numbers resulting in hub interface configuration cycles the GMCH propagates the Device Number field as A[15:11]. For Bus Numbers resulting in AGP bridge Type 1 Configuration cycles the Device Number is propagated as GAD[15:11].</p>
10:8	<p>Function Number. This field is mapped to AD[10:8] during PCIx configuration cycles. This allows the configuration registers of a particular function in a multi-function device to be accessed. The GMCH only responds to configuration cycles with a function number of 000b; all other function number values attempting access to the GMCH (Device Number = 0, 1 or 2, Bus Number = 0) will generate a master abort.</p>
7:2	<p>Register Number. This field selects one register within a particular Bus, Device, and Function as specified by the other fields in the Configuration Address Register. This field is mapped to AD[7:2] during PCI configuration cycles.</p>
1:0	Reserved.

3.3.2. CONF_DATA—Configuration Data Register

I/O Address: 0CFCh
 Default Value: 00000000h
 Access: Read/Write
 Size: 32 bits

CONF_DATA is a 32 bit read/write window into configuration space. The portion of configuration space that is referenced by CONF_DATA is determined by the contents of CONF_ADDR.

Bit	Descriptions
31:0	<p>Configuration Data Window (CDW). If bit 31 of CONF_ADDR is 1, any I/O reference that falls in the CONF_DATA I/O space is mapped to configuration space using the contents of CONF_ADDR.</p>

3.4. Host-Hub Interface Bridge/DRAM Controller Device Registers (Device 0)

Table 2 shows the GMCH configuration space for device #0.

Table 2. GMCH PCI Configuration Space (Device 0)

Address Offset	Mnemonic	Register Name	Default Value	Access
00–01h	VID	Vendor Identification	8086h	RO
02–03h	DID	Device Identification	1130h	RO
04–05h	PCICMD	PCI Command	0006h	R/W
06–07h	PCISTS	PCI Status	0090h (AGP) 0080h (GFX)	RO, R/WC
08h	RID	Revision Identification	02h (see note)	RO
09h	—	Reserved	00h	—
0Ah	SUBC	Sub-Class Code	00h	RO
0Bh	BCC	Base Class Code	06h	RO
0Ch	—	Reserved	00h	—
0Dh	MLT	Master Latency Timer	00h	RO
0Eh	HDR	Header Type	00h	RO
0Fh	—	Reserved	—	—
10–13h	APBASE	Aperture Base Configuration	00000008h (AGP) 00000000h (GFX)	R/W, RO
14–2Bh	—	Reserved	—	—
2C–2Dh	SVID	Subsystem Vendor Identification	0000h	R/WO
2E–2Fh	SID	Subsystem Identification	0000h	R/WO
30–33h	—	Reserved	—	—
34h	CAPPTR	Capabilities Pointer	00h (GFX) A0h (AGP)	RO
35–4Fh	—	Reserved	—	—
50h	GMCHCFG	GMCH Configuration	40h	R/W
51h	APCONT	Aperture Control	00h	R/WO/RO
52h	DRP	DRAM Row Population	00h	R/W
53h	DRAMT	DRAM Timing Register	00h	R/W
54h	DRP2	DRAM Row Population Register 2	00h	R/W
55–57h	—	Reserved	—	—
58h	FDHC	Fixed DRAM Hole Control	00h	R/W
59–5Fh	PAM	Programmable Attributes Map Registers	00h	R/W

Address Offset	Mnemonic	Register Name	Default Value	Access
60–6Fh	—	Reserved	—	—
70h	SMRAM	System Management RAM Control	00h	R/W
71h	—	Reserved	—	—
72–73h	MISCC	Miscellaneous Control Register	0000h	R/W,RO
74–87h	—	Reserved	—	—
88–8Bh	CAPID	Capability Identification	F104A009h	RO
8C–91h	—	Reserved	—	—
92–93h	BUFF_SC	Buffer Strength Control	FFFFh	R/W
94–95h	BUFF_SC2	Buffer Strength Control 2	FFFFh	R/W
96–9Fh	—	Reserved	—	—
A0–A3h	ACAPID	AGP Capability Identifier	00200002h	RO
A4–A7h	AGPSTAT	AGP Status	1F000207h	RO
A8–Abh	AGPCMD	AGP Command	00000000h	R/W
AC–Afh	—	Reserved	—	—
B0–B3h	AGPCTRL	AGP Control	00000000h	R/W
B4h	APSIZE	Aperture Size	00h	R/W
B5–B7h	—	Reserved	—	—
B8–BBh	ATTBASE	Aperture Translation Table Base	00000000h	R/W
BCh	AMTT	AGP Multi-Transaction Timer	00h	R/W
BDh	LPTT	Low Priority Transaction Timer	00h	R/W
BEh	MCHCFG	MCH Configuration	0000 x000b	R/W, RO
BF–CAh	—	Reserved	—	—
CBh	ERRCMD	Error Command	00h	R/W
CC–FFh	—	Reserved	—	—

Note: See Specification Update document for latest information.

3.4.1. VID—Vendor Identification Register (Device 0)

Address Offset:	00–01h
Default Value:	8086h
Attribute:	Read-Only
Size:	16 bits

The VID Register contains the vendor identification number. This 16-bit register combined with the Device Identification Register uniquely identify any PCI device. Writes to this register have no effect.

Bit	Description
15:0	Vendor Identification Number. This is a 16-bit value assigned to Intel. Intel VID = 8086h.

3.4.2. DID—Device Identification Register (Device 0)

Address Offset:	02–03h
Default Value:	1130h
Attribute:	Read-Only
Size:	16 bits

This 16-bit register combined with the Vendor Identification register uniquely identifies any PCI device. Writes to this register have no effect.

Bit	Description
15:0	Device Identification Number. This is a 16 bit value assigned to the GMCH Host-Hub Interface Bridge / DRAM Controller Device 0. 1130h = Device ID for Device 0.

3.4.3. PCICMD—PCI Command Register (Device 0)

Address Offset:	04–05h
Default:	0006h
Access:	Read/Write
Size:	16 bits

This register provides basic control over the PCI0 interface (hub interface) ability to respond to PCI cycles. The PCICMD Register enables and disables the SERR# signal, parity checking (PERR# signal), GMCH's response to PCI special cycles, and enables and disables PCI0 bus master accesses to main memory.

15										10		9	8			
Reserved (0)										FB2B (Not Impl)		SERR En				
7			6		5		4		3		2		1		0	
Addr/Data Stepping (Not Impl)			Parity Error En (Not Impl)		VGA Pal Sn (Not Impl)		Mem WR & Inval En (Not Impl)		Special Cycle En (Not Impl)		Bus Master En (Not Impl)		Mem Acc En (Not Impl)		I/O Acc En (Not Impl)	

Bit	Descriptions
15:10	Reserved.
9	Fast Back-to-Back. (Not implemented). Hardwired to 0. Selects whether the GMCH can generate fast back-to-back transactions to different PCI targets.
8	SERR Enable (SERRE). This bit is a global enable bit for Device 0 SERR messaging. The GMCH does not have an SERR# signal. The GMCH communicates the SERR# condition by sending an SERR message to the I/O Controller Hub. 1 = Enable. GMCH is enabled to generate SERR messages over the Hub interface for specific Device 0 error conditions 0 = Disable. SERR message is not generated by the GMCH for Device 0. NOTE: This bit only controls SERR messaging for Device 0. Device 1 has its own SERRE bit to control error reporting for error conditions occurring on Device 1. The two control bits are used in a logical OR manner to enable the SERR hub interface message mechanism.
7	Address/Data Stepping. (Not implemented). Hardwired to 0.
6	Parity Error Enable (PERRE). (Not implemented). Hardwired to 0. PERR# is not implemented by GMCH. Writes to this bit position have no affect.
5	VGA Palette Snoop. (Not implemented). Hardwired to 0. Writes to this bit position have no affect.
4	Memory Write and Invalidate Enable. The GMCH will never use this command and this bit is hardwired to 0. Writes to this bit position will have no affects.
3	Special Cycle Enable. (Not implemented). Hardwired to 0. The GMCH ignores all special cycles generated on the PCI.
2	Bus Master Enable (BME). (Not implemented). Hardwired to 1. The GMCH is always allowed to be a Bus Master. . Writes to this bit position have no affect.
1	Memory Access Enable (MAE). (Not implemented). Hardwired to 1. The GMCH always allows access to main memory. Writes to this bit position have no affect.
0	I/O Access Enable (IOAE). (Not implemented). Hardwired to 0. Writes to this bit position have no affect.

3.4.4. PCISTS—PCI Status Register (Device 0)

Address Offset:	06–07h
Default Value:	0090h
Access:	Read-Only, Read/Write Clear
Size:	16 bits

PCISTS is a 16-bit status register that reports the occurrence of a PCI master abort and PCI target abort on the PCI0 bus. PCISTS also indicates the DEVSEL# timing that has been set by the GMCH hardware for target responses on the PCI0 bus. Bits [15:12] and bit 8 are read/write clear and bits [10:9] are read-only.

15	14	13	12	11	10	9	8
Detected Par Error (HW=0)	Sig Sys Error	Recog Mast Abort Sta	Rec Target Abort Sta	Sig Target Abort Sta (HW=0)	DEVSEL# Timing (HW=00)	Data Par Detected (HW=0)	
7	6	5	4	3	0		
FB2B (HW=1)	Reserved			Cap List (HW=1)	Reserved		

Bit	Descriptions
15	Detected Parity Error (DPE). This bit is hardwired to a 0. Writes to this bit position have no affect.
14	Signaled System Error (SSE). 1 = GMCH Device 0 generates an SERR message over the hub interface for any enabled Device 0 error condition. Device 0 error conditions are enabled in the PCICMD register. Device 0 error flags are read/reset from the PCISTS register. 0 = Software sets SSE to 0 by writing a 1 to this bit.
13	Received Master Abort Status (RMAS). 1 = GMCH generates a hub interface request that receives a Master Abort completion packet. 0 = Software clears this bit by writing a 1 to it.
12	Received Target Abort Status (RTAS). 1 = GMCH generates a hub interface request that receives a Target Abort completion packet. 0 = Software clears this bit by writing a 1 to it.
11	Signaled Target Abort Status (STAS). (Not implemented). Hardwired to a 0. Writes to this bit position have no affect.
10:9	DEVSEL# Timing (DEVT). These bits are hardwired to 00. Writes to these bit positions have no affect. Device 0 does not physically connect to PCI0. These bits are set to 00 (fast decode) so that optimum DEVSEL timing for PCI0 is not limited by the GMCH.
8	Data Parity Detected (DPD). This bit is hardwired to a 0. Writes to this bit position have no affect.
7	Fast Back-to-Back (FB2B). This bit is hardwired to 1. Writes to these bit positions have no affect. Device 0 does not physically connect to PCI. This bit is set to 1 (indicating fast back-to-back capability) so that the optimum setting for PCI is not limited by the GMCH.
6:5	Reserved.
4	Capability List (CLIST). This bit is hardwired to 1 to indicate that the GMCH always has a capability list. The list of capabilities is accessed via register CAPPTR at configuration address offset 34h. Register CAPPTR contains an offset pointing to the address of the first of a linked list of capability registers. Writes to this bit position have no affect.
3:0	Reserved.

3.4.5. RID—Revision Identification Register (Device 0)

Address Offset: 08h
 Default Value: 02h (see Spec. Update document for latest information.)
 Access: Read-Only
 Size: 8 bits

This register contains the revision number of the Device 0. These bits are read-only and writes to this register have no effect.

Bit	Description
7:0	Revision Identification Number. This is an 8-bit value that indicates the revision identification number for Device 0. 02h = A-2 Stepping

3.4.6. SUBC—Sub-Class Code Register (Device 0)

Address Offset: 0Ah
 Default Value: 00h
 Access: Read-Only
 Size: 8 bits

This register contains the Sub-Class Code for the GMCH Function #0. The register is read-only.

Bit	Description
7:0	Sub-Class Code (SUBC). This is an 8-bit value that indicates the category of Bridge into which GMCH falls. 00h = Host Bridge.

3.4.7. BCC—Base Class Code Register (Device 0)

Address Offset: 0Bh
 Default Value: 06h
 Access: Read-Only
 Size: 8 bits

This register contains the Base Class Code of the GMCH Function #0. This register is read-only.

Bit	Description
7:0	Base Class Code (BASEC). This is an 8-bit value that indicates the Base Class Code for the GMCH. 06h = Bridge device.

3.4.8. MLT—Master Latency Timer Register (Device 0)

Address Offset:	0Dh
Default Value:	00h
Access:	Read-Only
Size:	8 bits

Device 0 is not a PCI master; therefore, this register is not implemented.

Bit	Descriptions
7:0	Master Latency Timer Value. This read-only field always returns 0 when read and writes have no affect.

3.4.9. HDR—Header Type Register (Device 0)

Address Offset:	0Eh
Default:	00h
Access:	Read-Only
Size:	8 bits

This register identifies the header layout of the configuration space. No physical register exists at this location.

Bit	Descriptions
7:0	Header Type. This read-only field always returns 0 when read and writes have no affect.

3.4.10. APBASE—Aperture Base Configuration Register (Device 0: AGP Mode Only)

Address Offset:	10–3h
Default Value (AGP Mode):	00000008h
Default Value (GFX Mode):	00000000h
Access:	Read/Write, Read-Only
Size:	32 bits

The APBASE is a standard PCI Base Address register that is used to set the base of the AGP aperture. The standard PCI Configuration mechanism defines the base address configuration register such that only a fixed amount of space can be requested (dependent on which bits are hardwired to “0” or behave as hardwired to “0”). To allow for flexibility (of the aperture) an additional register called APSIZE is used as a “back-end” register to control which bits of the APBASE will behave as hardwired to “0”. This register is programmed by the GMCH specific BIOS code that runs before any of the generic configuration software is run.

Note: Bit 1 of the APCONT register is used to prevent accesses to the aperture range before this register is initialized by the configuration software and the appropriate translation table structure has been established in the main memory.

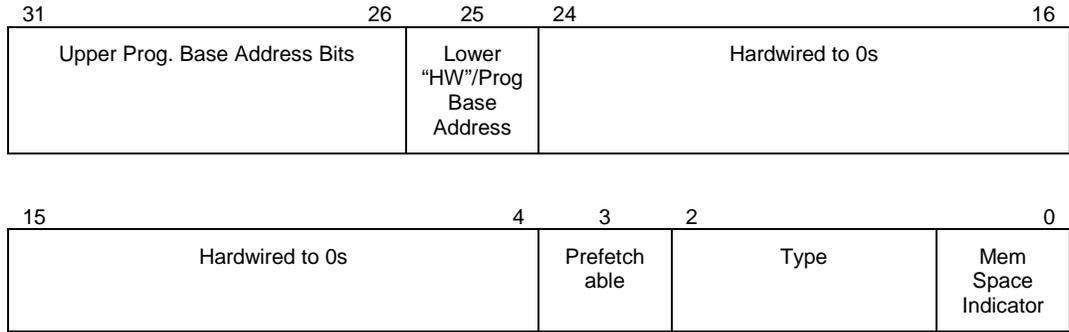

Bit	Description
31:26	<p>Upper Programmable Base Address bits—R/W. These bits are used to locate the range size selected via lower bits 25:4.</p> <p>Default = 0000</p>
25	<p>Lower "Hardwired"/Programmable Base Address bit . This bit behaves as "hardwired" or as programmable depending on the contents of the APSIZE register as defined below:</p> <p>Aperture Size = 32 MB → r/w</p> <p>Aperture Size = 64 MB → 0 (default)</p> <p>Bit 25 is controlled by the bit 3 of the APSIZE register in the following manner:</p> <ul style="list-style-type: none"> • If bit APSIZE[3]=0 (indicating 64 MB aperture size), then APBASE[25]=0. If APSIZE[3]=1, then APBASE[25]=r/w (read/write) allowing 32 MB aperture size if desired. • Default for APSIZE[3]=0b forces default APBASE[25] = 0b (bit responds as "hardwired" to 0). This provides a default to the maximum aperture size of 64 MB. The GMCH specific BIOS is responsible for selecting smaller size (if required) before PCI configuration software runs and establishes the system address map.
24:4	<p>Hardwired to 0. This forces minimum aperture size selected by this register to be 32 MB.</p>
3	<p>Prefetchable—RO. This bit is hardwired to 1 to identify the Graphics Aperture range as a prefetchable (i.e., There are no side effects on reads, the device returns all bytes on reads regardless of the byte enables, and the GMCH may merge processor writes into this range without causing errors).</p>
2:1	<p>Type—RO. These bits determine addressing type and they are hardwired to 00 to indicate that address range defined by the upper bits of this register can be located anywhere in the 32-bit address space.</p>
0	<p>Memory Space Indicator—RO. Hardwired to 0 to identify aperture range as a memory range.</p>

3.4.11. SVID—Subsystem Vendor Identification Register (Device 0)

Address Offset: 2C–2Dh
 Default: 0000h
 Access: Read/Write-Once
 Size: 16 bits

Bit	Description
15:0	Subsystem Vendor ID—R/WO. This value is used to identify the vendor of the subsystem. The default value is 0000h. This field should be programmed by BIOS during boot-up. Once written, this register becomes read-only. This Register can only be cleared by a Reset.

3.4.12. SID—Subsystem Identification Register (Device 0)

Address Offset: 2E–2Fh
 Default: 0000h
 Access: Read/Write-Once
 Size: 16 bits

Bit	Description
15:0	Subsystem ID—R/WO. This value is used to identify a particular subsystem. The default value is 0000h. This field should be programmed by BIOS during boot-up. Once written, this register becomes read-only. This Register can only be cleared by a Reset.

3.4.13. CAPPTR—Capabilities Pointer (Device 0)

Address Offset: 34h
 Default Value: 88h
 Access: Read-Only
 Size: 8 bits

The CAPPTR provides the offset that is the pointer to the location where the capability identification register is located.

Bit	Description
7:0	Pointer to Start of CAPPTR Linked List. 88h = Points to the CAPID register that provides capability information regarding the GMCH. The capabilities are determined by which fuses are blown.

3.4.14. GMCHCFG—GMCH Configuration Register (Device 0)

Address Offset: 50h
 Default: 01ss0s00
 Access: Read/Write, Read-Only
 Size: 8 bits

7	6	5	4	3	2	1	0
Mem Arb Gnt Win Enable	CPU Latency Timer	Reserved	Local Memory Frequency Select	DRAM Page Closing Policy	System Memory Frequency Select	Reserved	

Bit	Description
7	<p>Memory Arbiter Grant Window Enable (MAGWE). This bit controls the Host vs Low Priority Graphics timeslice regulation in the arbiter for the System DRAM.</p> <p>At pre-arbitration (aka, stage 1)</p> <p>0 = Disabled. Enforce fixed priority.</p> <p>1 = Limit grant to host-to-graphics stream to 6 consecutive packets.</p> <p>At main-arbitration (aka, stage 2)</p> <p>0 = Disabled. Enforce fixed priority.</p> <p>1 = 24 clocks limiting host, 24 clocks guaranteed to low priority graphics stream.</p> <p>In fixed mode arbitration (MAGWE=0) the host stream always has higher priority over the low priority graphics stream for accesses to system memory. In timeslice mode, the host stream and the low priority graphics stream are both regulated by a time window to provide fairness to the graphics stream. Fixed priority mode, where the host stream is always favored, is the recommended mode of operation; this setting gives highest system performance without adversely affecting graphics performance under real life applications workload.</p>
6	<p>CLT (CPU Latency Timer).</p> <p>0 = Deferrable processor cycle will be Deferred immediately after receiving another ADS#</p> <p>1 = Deferrable processor cycle will only be Deferred after in has been held in a “Snoop Stall” for 31 clocks and another ADS# has arrived (default).</p>
5	Reserved.
4	<p>Local Memory Frequency Select (LMFS). This bit selects the operating frequency for the Local Memory Controller. Default is set by sampling the LM_FREQ_SEL strap (AGP SBA[7] pin) at reset. It has a weak internal pull-up enabled during reset.</p> <p>This is a reserved bit in the UMA Only and No Internal Graphics SKUs. A 0 is read back in these SKUs. The output of the register bit in these SKUs is also forced to 0 such that a customer cannot effectively program the part for 133 MHz local memory. In the Fully-Featured and 100 MHz FSB & SM SKUs, either 1 or 0 can be programmed by the customer.</p> <p>1 = 133 MHz, (default). This is a reflection of LM_FREQ_SEL strap being pulled up (default).</p> <p>0 = 100 MHz. This is a reflection of LM_FREQ_SEL strap being pulled down.</p> <p>Note. The value of this bit should only be changed when the Internal Graphics device is disabled (i.e., GMS = 00).</p>

Bit	Description
3	<p>DRAM Page Closing Policy (DPCP). When this bit is a 0, the GMCH will tend to leave the DRAM pages open. In this mode the only times that the GMCH will close memory pages are:</p> <ul style="list-style-type: none"> 0 = Precharge Bank during service of a "Page Miss" access. Precharge All when changing from one Row to another if any Pages are open. Precharge All at leadin to a Refresh operation <p>When this bit is a 1, the GMCH will tend to leave the DRAM pages closed. In this the GMCH will:</p> <ul style="list-style-type: none"> 1 = Precharge All during the service of any "Page Miss" access. Precharge All when changing from one Row to another if any Pages are open. Precharge All at leadin to a Refresh operation.
2	<p>System Memory Frequency Select (SMFS). This bit selects the operating frequency for the main system memory.</p> <p>Default is set by sampling SBS0# pin at reset.</p> <ul style="list-style-type: none"> 0 = 100 MHz. 1 = 133 MHz. <p>The default is determined by SBS0# reset strap.</p>
1:0	Reserved.

3.4.15. APCONT—Aperture Control (Device 0)

Address Offset: 51h
 Default Value: 00h
 Access: Read/Write, Write-Once, Read-Only
 Size: 8 bits

The Aperture Control Register controls selection and access to aperture space.

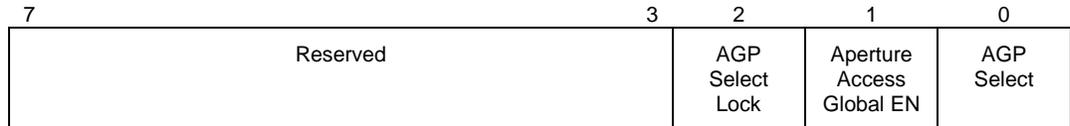

Bit	Description
7:3	Reserved.
2	<p>GFX AGP Select Lock—WO. This GFX AGP Select (bit 0) can be made read-only by this bit. This is a write-once bit. After it is written, this bit can not be changed without a system reset.</p> <p>0 = GFX AGP Select remains writeable. 1 = GFX AGP Select is read-only.</p>
1	<p>Aperture Access Global Enable—R/W. This bit is used to prevent access to the aperture from any port (processor, PCI0, or AGP/PCI1) before the aperture range is established by the configuration software and appropriate translation table in the main DRAM has been initialized. It must be set after system is fully configured for aperture accesses. Default is 0.</p>
0	<p>GFX AGP Select—R/W. This field selects the graphics device to be either AGP or Internal Graphics (GFX).</p> <p>0 = AGP Mode. AGP interface device is enabled. All registers in device 0 and device 1 are visible. No device 2 registers are visible; reads from those addresses return 1s.</p> <p>1 = GFX Mode. Internal Graphics device is enabled. All non-AGP related device 0 registers and all device 2 registers are visible. No device 1 registers are visible; reads from those addresses return 1s. Reads from AGP related device 0 registers return 0s. The internal graphics device does not respond to any configuration cycles unless SMRAM[7:6] (@ 70h) are NOT 00 AND APCONT[0] (@ 51h) is 1.</p> <p>R/W, RO if GFX AGP Select Lock (bit 2 =1)</p> <p>GFX AGP Select must be programmed before any other access is made to the configuration space. The two possible modes are mutually exclusive. This bit determines whether other configuration registers are enabled or disabled. This bit must be set as part of the initialization sequence. See Software Start-Up Sequence section.</p>

3.4.16. DRP—DRAM Row Population Register (Device 0)

Address Offset: 52h
 Default Value: 00h
 Access: Read/Write (Read-Only if D_LCK = 1)
 Size: 8 bits

The GMCH supports 6 physical rows of DRAM in 3 DIMMs. The width of a row is 64 bits. The DRAM Row Population Register defines the population of each side of each DIMM. Note that this entire register becomes read-only when the D_LCK bit is set to 1. For D_LCK bit description, see SMRAM register (Device 0, address offset 70h).

If the system memory interface is configured to run at 133 MHz, the system BIOS must use the DRP register (offset 52h) along with the DRP2 register (offset 52h) to detect whether the memory configuration exceeds 2 double-sided DIMMs or 3 single-sided DIMMs. If so, the system BIOS must down-shift the clock generator to 100 MHz to guarantee electrical integrity and timings.

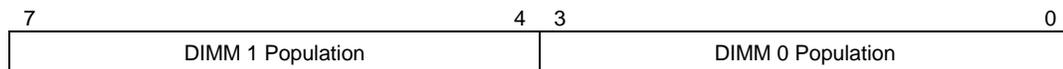

Bit	Description
7:4	DIMM 1 Population. This field indicates the population of DIMM 1. (See table below)
3:0	DIMM 0 Population. This field indicates the population of DIMM 0. (See table below)

Table 3. Supported System Memory DIMM Configurations

Register Code	DIMM Capacity	# of Devices / DIMM	# of Sides	DRAM Tech.	Front Side Population		Back Side Population		Row	Bank	Column
					Count	Config	Count	Config			
0	0			N/A	Empty		Empty		N/A	N/A	N/A
1	32 MB	16	DS	16 Mb	8 -	2 Mb x 8	8 -	2 Mb x 8	11	1	9
2	32 MB	4	SS	64 Mb	4 -	4 Mb x 16			12	2	8
3	48 MB	12	DS	64/16 Mb	4 -	4 Mb x 16	8 -	2 Mb x 8	12	2/1	8
4	64 MB	8	DS	64 Mb	4 -	4 Mb x 16	4 -	4 Mb x 16	12	2	8
5	64 MB	8	SS	64 Mb	8 -	8 Mb x 8			12	2	9
5	64 MB	4	SS	128 Mb	4 -	8 Mb x 16			12	2	9
6	96 MB	12	DS	64 Mb	8 -	8 Mb x 8	4 -	4 Mb x 16	12	2	9/8
6	96 MB	8	DS	128/64 Mb	4 -	8 Mb x 16	4 -	4 Mb x 16	12	2	9/8
7	128 MB	16	DS	64 Mb	8 -	8 Mb x 8	8 -	8 Mb x 8	12	2	9
7	128 MB	8	DS	128 Mb	4 -	8 Mb x 16	4 -	8 Mb x 16	12	2	9
9	128 MB	8	SS	128 Mb	8 -	16 Mb x 8			12	2	10
A	128 MB	4	SS	256 Mb	4 -	16 Mb x 16			13	2	9
B	192 MB	12	DS	128 Mb	8 -	16 Mb x 8	4 -	8 Mb x 16	12	2	10/9
B	192 MB	16	DS	128/64 Mb	8 -	16 Mb x 8	8 -	8 Mb x 8	12	2	10/9
C	256 MB	16	DS	128 Mb	8 -	16 Mb x 8	8 -	16 Mb x 8	12	2	10
D	256 MB	8	DS	256 Mb	4 -	16 Mb x 16	4 -	16 Mb x 16	13	2	9
E	256 MB	8	SS	256 Mb	8 -	32 Mb x 8			13	2	10
F	512 MB	16	DS	256 Mb	8 -	32 Mb x 8	8 -	32 Mb x 8	13	2	10

3.4.17. DRAMT—DRAM Timing Register (Device 0)

Address Offset: 53h
 Default Value: 00h
 Access: Read/Write
 Size: 8 bits

This register controls the operating mode and the timing of the DRAM Controller.

7	5	4	3	2	1	0
SDRAM Mode Select		DRAM Cycle Time	Intel Reserved	CAS# Latency	SDRAM RAS# to CAS# Dly	SDRAM RAS# Precharge

Bit	Description
7:5	<p>SDRAM Mode Select (SMS). These bits select the operational mode of the GMCH DRAM interface. The special modes are intended for initialization at power up.</p> <p>000 = DRAM in Self-Refresh Mode, Refresh Disabled (Default)</p> <p>001 = Normal Operation, 100 MHz System memory – Refresh interval 15.6 uSec 133 MHz System memory – Refresh interval 11.7 uSec</p> <p>010 = Normal Operation, 100 MHz System memory – Refresh interval 7.8 133 MHz System memory – Refresh interval 5.85 uSec</p> <p>011 = Normal Operation, 100 MHz System memory – Refresh interval 1.28 uSec 133 MHz System memory – Refresh interval 0.96 uSec</p> <p>100 = NOP Command Enable. In this mode all processor cycles to SDRAM result in a NOP Command on the SDRAM interface.</p> <p>101 = All Banks Precharge Enable. In this mode all processor cycles to SDRAM result in an All Banks Precharge Command on the SDRAM interface.</p> <p>110 = Mode Register Set Enable. In this mode all processor cycles to SDRAM result in a mode register set command on the SDRAM interface. The Command is driven on the MA[12:0] lines. MA[2:0] must always be driven to 010 for burst of 4 mode. MA3 must be driven to 1 for interleave wrap type. MA4 needs to be driven to the value programmed in the CAS# Latency bit. MA[6:5] should always be driven to 01. MA[12:7] must be driven to 00000. BIOS must calculate and drive the correct host address for each row of memory such that the correct command is driven on the MA[12:0] lines.</p> <p style="text-align: center;">Note that MAB[7:4]# are inverted from MAA[7:4]; BIOS must account for this.</p> <p>111 = CBR Enable. In this mode all processor cycles to SDRAM result in a CBR cycle on the SDRAM interface.</p>
4	<p>DRAM Cycle Time (DCT). This bit controls the number of SCLKs for an access cycle.</p> <p>0 = Tras = 5 SCLKs and Trc = 7 SCLKs (Default)</p> <p>1 = Tras = 7 SCLKs and Trc = 9 SCLKs.</p>
3	Intel Reserved.
2	<p>CAS# Latency (CL). This bit controls the number of CLKs between when a read command is sampled by the SDRAMs and when GMCH samples read data from the SDRAMs.</p> <p>0 = CAS# latency is 3 SCLKs.</p> <p>1 = CAS# latency is 2 SCLKs.</p>

Bit	Description
1	<p>SDRAM RAS# to CAS# Delay (SRCD). This bit controls the number of SCLKs from a Row Activate command to a read or write command.</p> <p>0 = 3 clocks are inserted between a row activate command and either a read or write command.</p> <p>1 = 2 clocks are inserted between a row activate and either a read or write command.</p>
0	<p>SDRAM RAS# Precharge (SRP). This bit controls the number of SCLKs for RAS# precharge.</p> <p>0 = 3 clocks of RAS# precharge are provided.</p> <p>1 = 2 clocks of RAS# precharge are provided</p>

3.4.18. DRP2—DRAM Row Population Register 2 (Device 0)

Address Offset:	54h
Default Value:	00h
Access:	Read/Write (Read-Only if D_LCK = 1)
Size:	8 bits

This register extends support to 6 physical rows of DRAM in 3 DIMMs. The width of a row is 64 bits. This second DRAM Row Population Register (DRP2) defines the population of each side of DIMM 2. Note that this entire register becomes read-only when the D_LCK bit is set. For D_LCK bit description, see SMRAM register (Device 0, address offset 70h).

If the system memory interface is configured to run at 133 MHz, the system BIOS must use the DRP register (offset 52h) along with the DRP2 register (offset 52h) to detect whether the memory configuration exceeds 2 double-sided DIMMs or 3 single-sided DIMMs. If so, the system BIOS must down-shift the clock generator to 100 MHz to guarantee electrical integrity and timings.

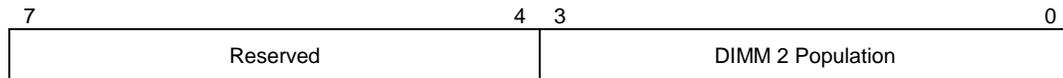

Bit	Description
7:4	Reserved.
3:0	<p>DIMM 2 Population. This field indicates the population of DIMM 2. Refer to the Supported System Memory DIMM Configurations table located with the DRP register definition. Note that some of the larger capacity DIMMs may not be supported in DIMM 2 based on the capacities of DIMM 0 and DIMM 1. The maximum supported main memory capacity is 512 MB.</p>

3.4.19. FDHC—Fixed DRAM Hole Control Register (Device 0)

Address Offset: 58h
 Default Value: 00h
 Access: Read/Write
 Size: 8 bits

This 8-bit register controls a single fixed DRAM hole: 15 MB–16 MB.



Bit	Description
7	Hole Enable (HEN). This field enables a memory hole in DRAM space. Host cycles matching an enabled hole are passed on to the I/O Controller Hub through the hub interface. Hub interface and PCI cycles matching an enabled hole are ignored by the GMCH. Note that a selected hole is not re-mapped. 0 = No Hole Enabled 1 = 15 MB–16 MB (1MB) Hole Enabled
6:0	Reserved.

3.4.20. PAM—Programmable Attributes Map Registers (Device 0)

Address Offset: 59–5Fh
 Default Value: 00h
 Attribute: Read/Write
 Size: 4 bits/register

The GMCH allows programmable memory attributes on 13 *Legacy* memory segments of various sizes in the 640 KB to 1 MB address range. Seven Programmable Attribute Map (PAM) Registers are used to support these features. Cacheability of these areas is controlled via the MTRR registers in the P6 processor. Two bits are used to specify memory attributes for each memory segment. These bits apply to both host, AGP/PCI, and hub interface initiator accesses to the PAM areas. These attributes are:

- **Read Enable (RE).** When RE = 1, the processor read accesses to the corresponding memory segment are claimed by the GMCH and directed to main memory. Conversely, when RE = 0, the host read accesses are directed to the hub interface/PCI0.
- **Write Enable (WE).** When WE = 1, the host write accesses to the corresponding memory segment are claimed by the GMCH and directed to main memory. Conversely, when WE = 0, the host write accesses are directed to the hub interface/PCI0.

The RE and WE attributes permit a memory segment to be Read-Only, Write Only, Read/Write, or disabled. For example, if a memory segment has RE = 1 and WE = 0, the segment is Read-Only.

Each PAM Register controls two regions, typically 16 KB in size. Each of these regions has a 4-bit field. The four bits that control each region have the same encoding and are defined in the following table.

Table 4. Attribute Bit Assignments

Bits [7, 3] Reserved	Bits [6, 2] Reserved	Bits [5, 1] WE	Bits [4, 0] RE	Description
X	X	0	0	Disabled. DRAM is disabled and all accesses are directed to the hub interface. The GMCH does not respond as a AGP/PCI or hub interface target for any read or write access to this area.
X	X	0	1	Read-Only. Reads are forwarded to DRAM and writes are forwarded to the hub interface for termination. This write protects the corresponding memory segment. The GMCH responds as a AGP/PCI or hub interface target for read accesses but not for any write accesses.
X	X	1	0	Write Only. Writes are forwarded to DRAM and reads are forwarded to the hub interface for termination. The GMCH responds as a AGP/PCI or hub interface target for write accesses but not for any read accesses.
X	X	1	1	Read/Write. This is the normal operating mode of main memory. Both read and write cycles from the host are claimed by the GMCH and forwarded to DRAM. The GMCH responds as a AGP/PCI or hub interface target for both read and write accesses.

As an example, consider a BIOS that is implemented on the expansion bus. During the initialization process, BIOS can be shadowed in main memory to increase the system performance. When BIOS is shadowed in main memory, it should be copied to the same address location. To shadow the BIOS, the attributes for that address range should be set to write only. BIOS is shadowed by first doing a read of that address. This read is forwarded to the expansion bus. The host then does a write of the same address, which is directed to main memory. After BIOS is shadowed, the attributes for that memory area are set to read-only so that all writes are forwarded to the expansion bus. The table above and the figure below show the PAM registers and the associated attribute bits.

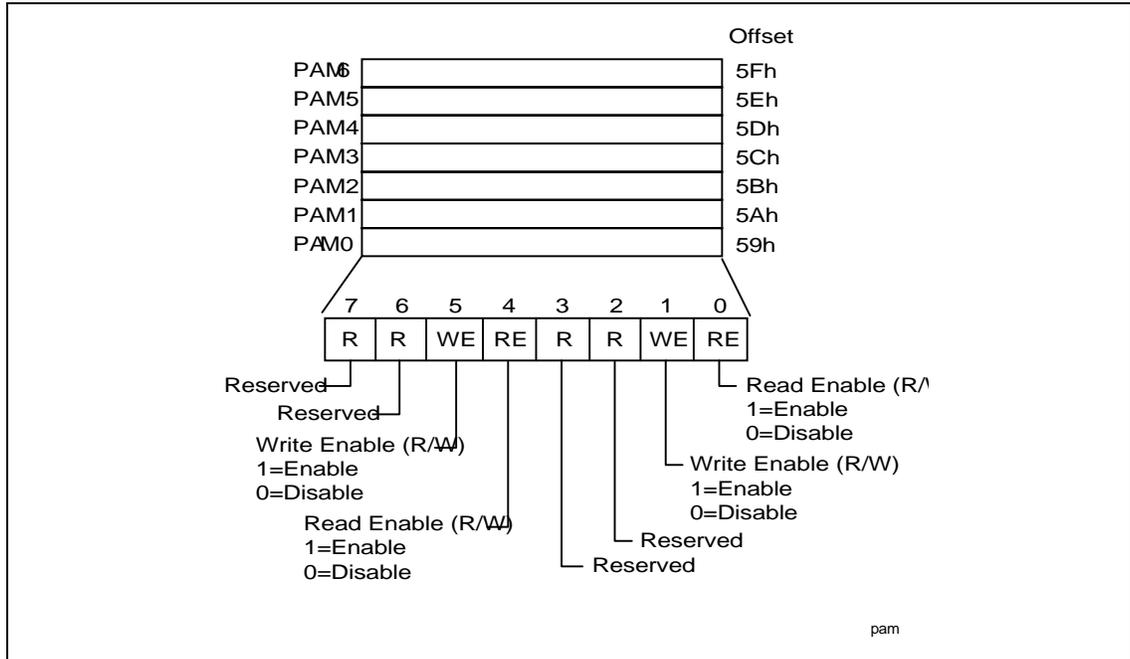
Figure 3. PAM Registers

Table 5. PAM Registers and Associated Memory Segments

PAM Reg	Attribute Bits				Memory Segment	Comments	Offset
PAM0[3:0]	Reserved						59h
PAM0[7:4]	R	R	WE	RE	0F0000h–0FFFFFFh	BIOS Area	59h
PAM1[3:0]	R	R	WE	RE	0C0000h–0C3FFFh	ISA Add-on BIOS	5Ah
PAM1[7:4]	R	R	WE	RE	0C4000h–0C7FFFh	ISA Add-on BIOS	5Ah
PAM2[3:0]	R	R	WE	RE	0C8000h–0CBFFFh	ISA Add-on BIOS	5Bh
PAM2[7:4]	R	R	WE	RE	0CC000h–0CFFFFh	ISA Add-on BIOS	5Bh
PAM3[3:0]	R	R	WE	RE	0D0000h–0D3FFFh	ISA Add-on BIOS	5Ch
PAM3[7:4]	R	R	WE	RE	0D4000h–0D7FFFh	ISA Add-on BIOS	5Ch
PAM4[3:0]	R	R	WE	RE	0D8000h–0DBFFFh	ISA Add-on BIOS	5Dh
PAM4[7:4]	R	R	WE	RE	0DC000h–0DFFFFh	ISA Add-on BIOS	5Dh
PAM5[3:0]	R	R	WE	RE	0E0000h–0E3FFFh	BIOS Extension	5Eh
PAM5[7:4]	R	R	WE	RE	0E4000h–0E7FFFh	BIOS Extension	5Eh
PAM6[3:0]	R	R	WE	RE	0E8000h–0EBFFFh	BIOS Extension	5Fh
PAM6[7:4]	R	R	WE	RE	0EC000h–0EFFFFh	BIOS Extension	5Fh

DOS Area (00000h–9FFFFh)

The DOS area is 640 KB in size is always mapped to the main memory controlled by the GMCH.

Video Buffer Area (A0000h–BFFFFh)

The 128 KB graphics adapter memory region is normally mapped to a legacy video device on the hub interface/PCI (typically VGA controller). This area is not controlled by attribute bits and processor – initiated cycles in this region are forwarded to either the hub interface or the AGP/Internal Graphics Device for termination. This region is also the default region for SMM space.

Accesses to this range are directed to either the hub interface or the AGP/internal Graphics Device based on the configuration. The configuration is specified by:

1. AGP on/off configuration bit
2. AGP off: GMS bits of the SMRAM register in the GMCH Device 0 configuration space. There is additional steering information coming from the Device 2* configuration registers and from some of the VGA registers in the Graphics device.
3. AGP on: GMCHCFG (Device 0, bit 5, PCI-PCI Command) and BCTRL (Device 1, bit 3, PCI-PCI Bridge Control) configuration registers

Control is applied for accesses initiated from any of the system interfaces; that is, processor bus, the hub interface, or AGP (if enabled). Note that for the hub interface to AGP/PCI accesses, only memory write operations are supported. Any AGP/PCI initiated VGA accesses targeting the GMCH will master abort. For more details, see the descriptions in the configuration registers specified above.

The SMRAM Control register controls how SMM accesses to this space are treated.

Monochrome Adapter (MDA) Range (B0000h–B7FFFh)

Legacy support requires the ability to have a second graphics controller (monochrome) in the system.

In an AGP system, accesses in the standard VGA range are forwarded to the AGP bus (depending on configuration bits). Since the monochrome adapter may be on the hub interface/PCI (or ISA) bus, the GMCH must decode cycles in the MDA range and forward them to the hub interface. This capability is controlled by a configuration bit (MDA bit – Device 0, BEh). In addition to the memory range B0000h to B7FFFh, the GMCH decodes I/O cycles at 3B4h, 3B5h, 3B8h, 3B9h, 3Bah and 3BFh and forwards them to the hub interface.

In an internal graphics system, the GMS bits of the SMRAM register in Device 0, bits in the Device 2 PCICMD register, and bits from some of the VGA registers control this functionality.

Expansion Area (C0000h–DFFFFh)

This 128 KB ISA Expansion region is divided into eight 16 KB segments. Each segment can be assigned one of four Read/Write states: read-only, write-only, read/write, or disabled. Typically, these blocks are mapped through GMCH and are subtractively decoded to ISA space. Memory that is disabled is not remapped.

Extended System BIOS Area (E0000h–EFFFFh)

This 64 KB area is divided into four 16 KB segments. Each segment can be assigned independent read and write attributes so it can be mapped either to main DRAM or to the hub interface. Typically, this area is used for RAM or ROM. Memory segments that are disabled are not remapped elsewhere.

System BIOS Area (F0000h–FFFFFFh)

This area is a single 64 KB segment. This segment can be assigned read and write attributes. It is by default (after reset) read/write disabled and cycles are forwarded to the hub interface. By manipulating the read/write attributes, the GMCH can “shadow” BIOS into the main DRAM. When disabled, this segment is not remapped.

3.4.21. SMRAM—System Management RAM Control Register (Device 0)

Address Offset: 70h
 Default Value: 00h
 Access: Read/Write, Read-Only
 Size: 8 bits

The SMRAM register controls how accesses to Compatible and Extended SMRAM spaces are treated, and how much (if any) memory is “Stolen” from the system to support both SMRAM and graphics local memory needs.

7	6	5	4	3	2	1	0
Graphics Mode Select		Upper SMM Select		Lower SMM Select		SMM Space Locked	E_SMRA M_ERR

Bit	Description
7:6	<p>Graphics Mode Select (GMS). This field is used to enable/disable the Internal Graphics device and select the amount of main memory that is “Stolen” to support the internal graphics device in VGA (non-linear) mode only. These 2 bits only have meaning if we are not in AGP mode.</p> <p>00 = Internal graphics device Disabled, No memory “Stolen” 01 = Internal graphics device Enabled, No memory “Stolen” 10 = Internal graphics device Enabled, 512 KB of memory “Stolen” for frame buffer. 11 = Internal graphics device Enabled, 1 MB of memory “Stolen” for frame buffer.</p> <p>Notes:</p> <ul style="list-style-type: none"> When the internal graphics device is disabled (00), the graphics device and all of its memory and I/O functions are disabled and the clocks to this logic are turned off; memory accesses to the VGA range (A0000–BFFFF) are forwarded on to the hub interface and the graphics local memory space is NOT “stolen” from main memory. Any change to the SMRAM register will not affect AGP mode or cause the controller to go into AGP mode. When this field is non-zero, the internal graphics device and all of its memory and I/O functions are enabled; all non-SMM memory accesses to the VGA range will be handled internally and the selected amount of graphics local memory space (0, 512 KB or 1 MB) is “stolen” from the main memory. Graphics memory is “stolen” AFTER TSEG memory is “stolen”. Once D_LCK is set, these bits becomes read-only. GMCH does not support VGA on local memory. Software must not use the 01 mode for VGA.

Bit	Description
5:4	<p>Upper SMM Select (USMM). This field is used to enable/disable the various SMM memory ranges above 1 MB. TSEG is a block of memory (“Stolen” from Main Memory at [TOM-Size] : [TOM]) that is only accessible by the processor and only while operating in SMM mode. HSEG is a remap of the AB segment at FEEA0000 : FEEBFFFF. Both of these areas, when enabled, are usable as SMM RAM.</p> <p>00 = TSEG and HSEG are both disabled 01 = TSEG is disabled, HSEG is conditionally enabled 10 = TSEG is enabled as 512 KB and HSEG is conditionally enabled 11 = TSEG is enabled as 1 MB and HSEG is conditionally enabled</p> <p>Note:</p> <ul style="list-style-type: none"> • Non-SMM Operations (SMM processor accesses and all other access) that use these address ranges are forwarded to the hub interface. • Once D_LCK is set, these bits becomes read-only. • HSEG is ONLY enabled if LSMM = 00.
3:2	<p>Lower SMM Select (LSMM). This field controls the definition of the AB segment SMM space.</p> <p>00 = AB segment disabled (no one can write to it). 01 = AB segment enabled as general system RAM (anyone can write to it). 10 = AB segment enabled as SMM Code RAM shadow. Only SMM code reads can access DRAM in the AB segment (processor code reads only). SMM Data operations and all Non-SMM Operations go to either the internal graphics device or are broadcast on the hub interface. 11 = AB segment enabled as SMM RAM. All SMM operations to the AB segment are serviced by DRAM, all Non-SMM operations go to either the internal graphics device or are broadcast on the hub interface (processor SMM R/W can access SMM space).</p> <p>When D_LCK is set, bit 3 becomes read-only, and bit 2 is writable ONLY if bit 3 is a 1. When bit 3 is set, only the processor can access it.</p>
1	<p>SMM Space Locked (D_LCK). When D_LCK is set to 1 then D_LCK, GMS, USMM, and the most significant bit of LSMM become read-only. D_LCK can be set to 1 via a normal configuration space write but can only be cleared by a reset. The combination of D_LCK and LSMM provide convenience with security. The BIOS can use LSMM=01 to initialize SMM space and then use D_LCK to “lock down” SMM space in the future so that no application software (or BIOS itself) can violate the integrity of SMM space, even if the program has knowledge of the LSMM function. This bit also Locks the DRP and DRP2 registers.</p>
0	<p>E_SMRAM_ERR (E_SMERR).</p> <p>1 = This bit is set when processor accesses the defined memory ranges in Extended SMRAM (HSEG or TSEG) while not in SMM mode. This bit is Not set for the case of an explicit write-back operation. 0 = It is software’s responsibility to clear this bit. Software must write a 1 to this bit to clear it.</p>

3.4.22. MISCC—Miscellaneous Control Register (Device 0)

Address Offset: 72–73h
 Default Value: 0000h
 Access: Read/Write, Read-Only
 Size: 16 bits

This register holds all of the miscellaneous control bits for the GMCH .

15	14	12	11	10	8		
SM GFX 133 Enable	Reserved	CPC Mask	Reserved				
7	6	5	4	3	2	1	0
Read PWR Throttle Cntl	Write PWR Throttle Cntl	Throttle Lock	Reserved	BNR Looka head	GFX LM Win Size Sel		

Bit	Description
15	<p>System Memory Graphics PC133 Enable—R/W. This bit allows the GMCH to operate in Graphics Mode with Enhanced System Memory (PC133). Normally, SM frequency is locked to 100 MHz in Internal Graphics mode, and GMCHCFG[2] (SMFS) is read-only. Setting this bit allows the SM frequency to be changed by writing to GMCHCFG[2]. This bit has no effect in AGP mode.</p> <p>0 = Normal Operation. GMCHCFG[2] hardwired to 0 when GMCH is in Graphics Mode (i.e., APCONT[0] = 1)</p> <p>1 = Allow 133 MHz System Memory when the GMCH is in Graphics Mode. Note that this just enables PC133. To actually run graphics with 133 MHz SM, GMCHCFG[2] must be set to 1. Also, this bit should be set by BIOS before GMCH is changed from AGP to Graphics mode via APCONT[0].</p>
14	Reserved.
13	<p>SM Transmit Stage Bypass—R/W.</p> <p>0 = Normal Operation (Default). Bypass if SM=100 MHz; No bypass if SM=133 MHz.</p> <p>1 = Always bypass, regardless of SM frequency.</p> <p>System BIOS should set this bit to 1 to enable the bypass and optimize system memory latency by one clock for 133 MHz operation (has no affect on 100 MHz operation).</p>
12	Reserved.
11	<p>CPC Mask Enable—R/W.</p> <p>0 = Normal Operation (default).</p> <p>1 = Never perform command per clock accesses to system memory. Mask command per clock.</p> <p>Note: This bit must be set to 1 if using 133 MHz system memory.</p>
10:8	Reserved.

Bit	Description
7:6	<p>Read Power Throttle Control—R/W. These bits select the Power Throttle Bandwidth Limits for read operations to system memory.</p> <p>R/W, RO if Throttle Lock (bit 3 =1). These bits are locked (read-only) when bit 3 (Throttle Lock) is 1.</p> <p>00 = No Limit (800 MB/Sec) (Default)</p> <p>01 = Limit at 87 ½ % (700 MB/Sec)</p> <p>10 = Limit at 75 % (600 MB/Sec)</p> <p>11 = Limit at 62 ½ % (500 MB/Sec)</p>
5:4	<p>Write Power Throttle Control—R/W. These bits select the Power Throttle Bandwidth Limits for Write operations to System Memory.</p> <p>R/W, RO if Throttle Lock (bit 3 =1). These bits are locked (read-only) when bit 3 (Throttle Lock) is 1.</p> <p>00 = No Limit (800 MB/Sec) (Default)</p> <p>01 = Limit at 62 ½ % (500 MB/Sec)</p> <p>10 = Limit at 50 % (400 MB/Sec)</p> <p>11 = Limit at 37 ½ % (300 MB/Sec)</p> <p>Note: These bits must be set to '01' if using 100 MHz system memory and '10' if using 133 MHz system memory.</p>
3	<p>Throttle Lock—R/W.</p> <p>R/W, RO if Throttle Lock (bit 3 =1). Once set, this bit can only be cleared by a reset.</p> <p>0 = Bits [7:3] remain writeable</p> <p>1 = Block writes to bits [7:3]</p>
2	Reserved—RO.
1	<p>BNR Lookahead—R/W. This enables the HT unit to look further up the data path to optimize the BNR (Block New Requests) signal to increase our effective IOQ (In Order Queue) depth.</p> <p>0 = Normal Behavior (default)</p> <p>1 = BNR Lookahead Enable</p>
0	<p>Graphics Translation Window Size Select—R/W. In GFX mode this would be the size of the GTT (Graphics Translation Table). Not a valid bit in AGP mode.</p> <p>0 = 64 MB (default)</p> <p>1 = 32 MB.</p>

3.4.23. CAPID—Capability Identification (Device 0: AGP Mode Only)

Address Offset:	88–8Bh
Default Value:	F104 A009h
Access:	Read-Only
Size:	32 bits

This register uniquely identifies chipset capabilities as defined in the table below. Writes to this register have no effect.

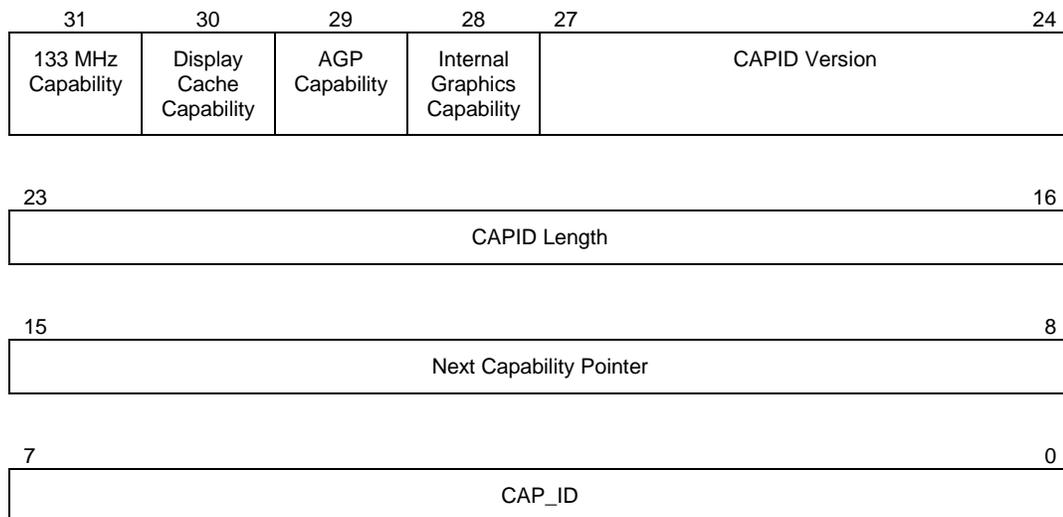

Bit	Description
31	<p>133 MHz Capability—RO.</p> <p>0 = Component is capable of up to 100 MHz front side bus and system memory. 1 = Component is capable of up to 133 MHz front side bus and system memory.</p>
30	<p>Display Cache Capability—RO.</p> <p>0 = Only supports UMA mode (no local memory). 1 = Component is local memory (Display Cache) and UMA capable.</p>
29	<p>AGP Capability—RO.</p> <p>0 = AGP mode not supported. Note that the AGP interface may still be active through the addition of an AIMM card if bits 28 and 30 are both 1. 1 = AGP mode supported.</p>
28	<p>Internal Graphics Capability—RO.</p> <p>0 = Internal graphic controller not supported. 1 = Internal graphic controller supported.</p>
27:24	<p>CAPID Version—RO. This field has the value 0001b to identify the first revision of the CAPID register definition.</p>
23:16	<p>CAPID Length—RO. This field has the value 04h to indicate the structure length.</p>

Bit	Description
15:8	Next Capability Pointer—RO. This field has two possible values based on APCONT[0] at offset 51h: A0h when APCONT[0] = 0 (AGP Mode) meaning the next capability pointer is ACAPID. 00h when APCONT[0] = 1 (GFX Mode) meaning that this was the last capability pointer in the list.
7:0	CAP_ID—RO. This field has the value 1001b to identify the CAP_ID assigned by the PCI SIG for vendor dependent capability pointers.

3.4.24. BUFF_SC—System Memory Buffer Strength Control Register (Device 0)

Address Offset:	92–93h
Default Value:	FFFFh
Access:	Read/Write
Size:	16 bits

This register programs the system memory DRAM interface signal buffer strengths, with the exception of the CKEs. The programming of these bits should be based on DRAM density (x8 or x16), DRAM technology (16Mb, 64Mb, 128Mb or 256 Mb), rows populated, etc.. Note that x4 & x32 DRAMs are not supported. Registered DIMMs and DIMMS with ECC are also not supported and BIOS upon detection of ECC via SPD, should report to the user that ECC DIMM timings are not supported by the GMCH.

In the descriptions below, the term “Row” is equivalent to one side of one DIMM. In other words, a “single-sided” DIMM contains one populated row (always an odd numbered), and one empty row (even numbered). A “double-sided” DIMM contains two populated rows.

All buffer strengths are based on the number of “loads” connected to each pin of a given signal group. A “load” represents one pin of one SDRAM Device. The GMCH pin is implied and not counted in the load equations. The number of loads on a given signal for a given configuration can be determined entirely from the width of the SDRAM devices that populate each row in the configuration. This information is readily available for each row via the Serial Presence Detect mechanism.

15	14	13	12	11	10	9	8
SCS[5]# Buffer Strength	SCS[4]# Buffer Strength	SCS[3]# Buffer Strength	SCS[2]# Buffer Strength	SCS[1]# Buffer Strength	SCS[0]# Buffer Strength	SMAC[7:4]# Buffer Strength	
7	6	5	4	3	2	1	0
SMAB[7:4]# Buffer Strength		SMAA[7:4] Buffer Strength		MD and DQM Buffer Strengths		Control Buffer Strengths	

Bit	Description
15	<p>SCS[5]# Buffer Strength (Row 5).</p> <p>0 = Reserved 1 = 1.0x 0 or 2 load or 4 loads</p> <p>Each Row is actually selected by a pair of chip select signals (SCSA[n]# and SCSB[n]#). The number of SCS# loads for a given row can be determined from SPD data using the following equation:</p> $\text{Loads} = 32 / (\text{width of SDRAM devices in row})$
14	<p>SCS[4]# Buffer Strength (Row 4).</p> <p>0 = Reserved 1 = 1.0x 0 or 2 load or 4 loads</p>
13	<p>SCS[3]# Buffer Strength (Row 3).</p> <p>0 = Reserved 1 = 1.0x 0 or 2 load or 4 loads</p>
12	<p>SCS[2]# Buffer Strength (Row 2).</p> <p>0 = Reserved 1 = 1.0x 0 or 2 load or 4 loads</p>
11	<p>SCS[1]# Buffer Strength (Row 1).</p> <p>0 = Reserved 1 = 1.0x 0 or 2 load or 4 loads</p>
10	<p>SCS[0]# Buffer Strength (Row 0).</p> <p>0 = Reserved 1 = 1.0x 0 or 2 load or 4 loads</p>
9:8	<p>SMAC[7:4]# Buffer Strength (Rows 4/5).</p> <p>00 = 2.7x > 8 loads 01 = 1.7x 8 loads 10 = 1.0x 0 or 4 loads 11 = 1.0x 0 or 4 loads</p> <p>Separate copies of these SMA*[7:4] "Command-Per-Clock" signals are provided for each DIMM. So the loads for each copy are determined by the number of SDRAM devices on the corresponding DIMM (4, 8, 12, or 16 loads). The number of loads for each SMA*[7:4] signal group can be determined from SPD data using the following equation:</p> $\text{Loads} = (64 / (\text{SDRAM Device Width for 1}^{\text{st}} \text{ row})) + (64 / (\text{SDRAM Device Width for 2}^{\text{nd}} \text{ row}))$
7:6	<p>SMAB[7:4]# Buffer Strength (Rows 2/3).</p> <p>00 = 2.7x > 8 loads 01 = 1.7x 8 loads 10 = 1.0x 0 or 4 loads 11 = 1.0x 0 or 4 loads</p>

Bit	Description
5:4	<p>SMAA[7:4] Buffer Strength (Rows 0/1).</p> <p>00 = 2.7x > 8 loads 01 = 1.7x 8 loads 10 = 1.0x 0 or 4 loads 11 = 1.0x 0 or 4 loads</p>
3:2	<p>SMD[63:0] and SDQM[7:0] Buffer Strengths (All Rows).</p> <p>00 = Reserved (1.7x) 01 = Reserved (0.7x) 10 = Reserved (1.0x) 11 = 1.0x 1-6 loads</p> <p>The load on the SMD and SDQM signals is a function only of the number of populated rows in the system (range 1 to 6 loads):</p> <p style="padding-left: 40px;">Loads = Number of populated rows.</p>
1:0	<p>SWE#, SCAS#, SRAS#, SMAA[11:8, 3:0], SBS[1:0] Control Buffer Strengths (All Rows).</p> <p>00 = 1.7x > 16 loads 01 = 0.7x < 8 loads 10 = 1.0x 8-16 loads 11 = 1.0x 8-16 loads</p> <p>The load on the address and control signals (other than SMA*[7:4] above) is simply the number of devices populated in ALL rows (range from 4 to 48 loads!).</p> <p style="padding-left: 40px;">Loads = (64 / Row 0 Device Width) + (64 / Row 1 Device Width) + (64 / Row 2 Device Width) + (64 / Row 3 Device Width) + (64 / Row 4 Device Width) + (64 / Row 5 Device Width)</p>

3.4.25. BUFF_SC2—System Memory Buffer Strength Control Register 2 (Device 0)

Address Offset: 94–95h
 Default Value: FFFFh
 Access: Read/Write
 Size: 16 bits

This register programs the system memory DRAM interface CKE signal buffer strengths. See BUFF_SC register for the remainder of the buffer strength controls.

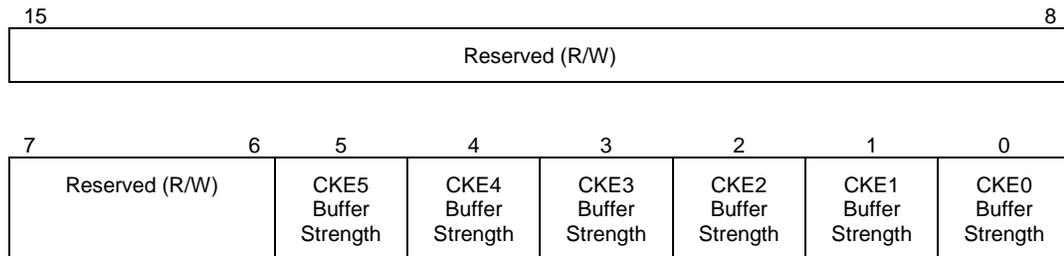

Bit	Description
15:6	Reserved.
5	<p>SCKE[5] Buffer Strength (Row 5).</p> <p>0 = 2.7x 8 loads 1 = 1.7x 0 or 4 loads</p> <p>The load on a given SCKE signal is equal to the number of SDRAM devices for that particular row (either 4 or 8 loads).</p> <p>Loads = (64 / SDRAM Device Width for this row)</p>
4	<p>SCKE[4] Buffer Strength (Row 4).</p> <p>0 = 2.7x 8 loads 1 = 1.7x 0 or 4 loads</p>
3	<p>SCKE[3] Buffer Strength (Row 3).</p> <p>0 = 2.7x 8 loads 1 = 1.7x 0 or 4 loads</p>
2	<p>SCKE[2] Buffer Strength (Row 2).</p> <p>0 = 2.7x 8 loads 1 = 1.7x 0 or 4 loads</p>
1	<p>SCKE[1] Buffer Strength (Row 1).</p> <p>0 = 2.7x 8 loads 1 = 1.7x 0 or 4 loads</p>
0	<p>SCKE[0] Buffer Strength (Row 0).</p> <p>0 = 2.7x 8 loads 1 = 1.7x 0 or 4 loads</p>

3.4.26. SM_RCOMP—System Memory R Compensation Control Register (Device 0)

Address Offset: 98–9Bh
 Default Value: XXXXXXXXh
 Access: Read/Write, Read-Only
 Size: 32 bits

This register controls the system memory Rcomp buffers (both horizontally and vertically oriented).

31	30	23	22	20	19	18	16
V Override Enable	Reserved	SRCOMP_VP		Reserved	SRCOMP_VN		
15	14	7	6	4	3	2	0
H Override Enable	Reserved	SRCOMP_HP		Reserved	SRCOMP_HN		

Bit	Description
31	SRCOMP_V Override Enable—R/W. 0 = SM Rcomp is active for vertically oriented buffers (Default). 1 = SM Rcomp is NOT-active for vertically oriented buffers.
30:23	Reserved.
22:20	SRCOMP_VP—RO or R/W. P-Channel Compensation Value for Vertical Buffers. This value is generated by the Rcomp logic to control the drive characteristics of the vertically oriented P-channel devices in the SM buffers. In Normal operation , field is read-only and reflects current compensation. In Override Mode (see bit 31), field is written with desired compensation value which is loaded via software when SM Rcomp operation is disabled.
19	Reserved.
18:16	SRCOMP_VN—RO or R/W. N-Channel Compensation Value for Vertical Buffers. This value is generated by the Rcomp logic to control the drive characteristics of the vertically oriented N-channel devices in the SM buffers. In Normal operation , field is read-only and reflects current compensation. In Override Mode (see bit 31), field is written with desired compensation value which is loaded via software when SM Rcomp operation is disabled.
15	SRCOMP_H Override Enable—R/W. 0 = SM Rcomp is active for horizontally oriented buffers (Default). 1 = SM Rcomp is NOT-active for horizontally oriented buffers.
14:7	Reserved.

Bit	Description
6:4	<p>SRCOMP_HP—RO or R/W. P-Channel Compensation Value for Horizontal Buffers. This value is generated by the Rcomp logic to control the drive characteristics of the horizontally oriented P-channel devices in the SM buffers.</p> <p>In Normal operation, field is read-only and reflects current compensation.</p> <p>In Override Mode (see bit 15), field is written with desired compensation value which is loaded via software when SM Rcomp operation is disabled.</p>
3	Reserved.
2:0	<p>SRCOMP_HN—RO or R/W. N-Channel Compensation Value for Horizontal Buffers. This value is generated by the Rcomp logic to control the drive characteristics of the horizontally oriented N-channel devices in the SM buffers.</p> <p>In Normal operation, field is read-only and reflects current compensation.</p> <p>In Override Mode (see bit 15), field is written with desired compensation value which is loaded via software when SM Rcomp operation is disabled.</p>

3.4.27. SM—System Memory Control Register

Address Offset:	9C–9Fh
Default Value:	XXXXXXXXh
Access:	Read/Write, Read-Only
Size:	32 bits

This register controls the two System Memory Delay Locked Loop (DLL) blocks that offset the transmit and receive clocks used to interface with the external SDRAM devices. The Transmit DLL provides an early version of SCLK to provide additional setup margin to the external SDRAM devices. The Receive DLL provides a late version of SCLK to provide additional setup time on read data driven by the SDRAM devices back to the GMCH.

By default, the Transmit DLL is enabled (whether the operating frequency is 100 MHz or 133 MHz). The Receive DLL is always bypassed, regardless of operating frequency. When the RDLL is bypassed, the RDLL Bias field, instead, controls a buffer delay chain with programmable tap points. This chain has 8 tap points each with approximately 200 ps of incremental delay at the slow corner (total delay range 0 to 1.4 ns) and about 80 ps of incremental delay at the “fast” corner (0 to 0.56 ns total range).

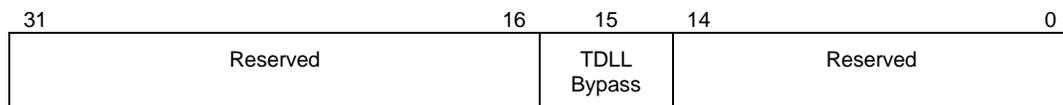

Bit	Description
31:16	Reserved.
15	<p>Transmit DLL Enable (TDLLE)—R/W.</p> <p>0 = TDLL Enabled (Default)</p> <p>1 = TDLL Disabled and bypassed</p>
14:0	Reserved.

3.4.28. ACAPID—AGP Capability Identifier Register (Device 0: AGP Mode Only)

Address Offset: A0–A3h
 Default Value: 00200002h
 Access: Read-Only
 Size: 32 bits

This register provides standard identifier for AGP capability.

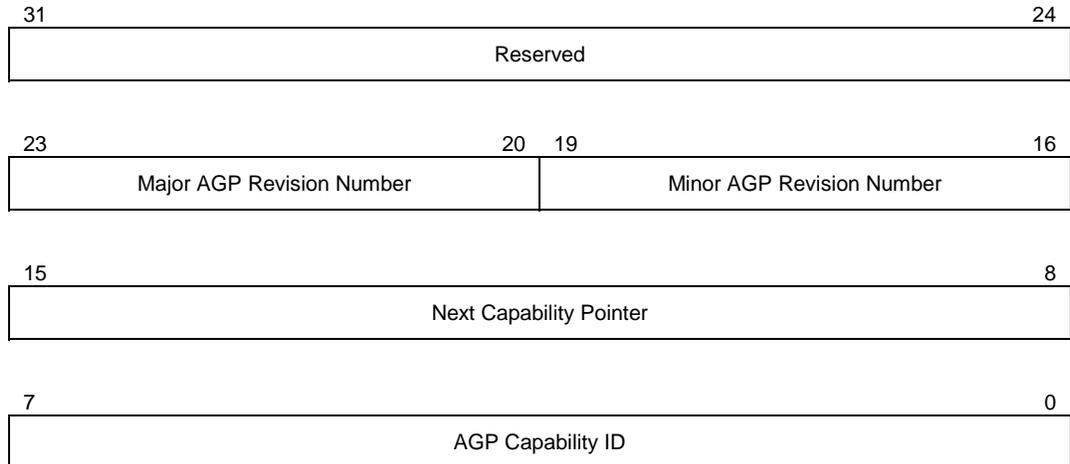

Bit	Description
31:24	Reserved.
23:20	Major AGP Revision Number. These bits provide a major revision number of AGP specification that this version of GMCH conforms. These bits are set to the value 0010b to indicate AGP Rev. 2.x.
19:16	Minor AGP Revision Number. These bits provide a minor revision number of AGP specification that this version of GMCH conforms. This number is hardwired to a value of "0000" (i.e., implying Rev x.0). Together with major revision number this field identifies GMCH as an AGP REV 2.0 compliant device.
15:8	Next Capability Pointer. AGP capability is the first and the last capability described via the capability pointer mechanism; therefore, these bits are hardwired to 0s to indicate the end of the capability linked list.
7:0	AGP Capability ID. This field identifies the linked list item as containing AGP registers. This field has the value 0000_0010b as assigned by the PCI SIG.

3.4.29. AGPSTAT—AGP Status Register (Device 0: AGP Mode Only)

Address Offset: A4–A7h
 Default Value: 1F00207h
 Access: Read-Only
 Size: 32 bits

This register reports AGP device capability/status.

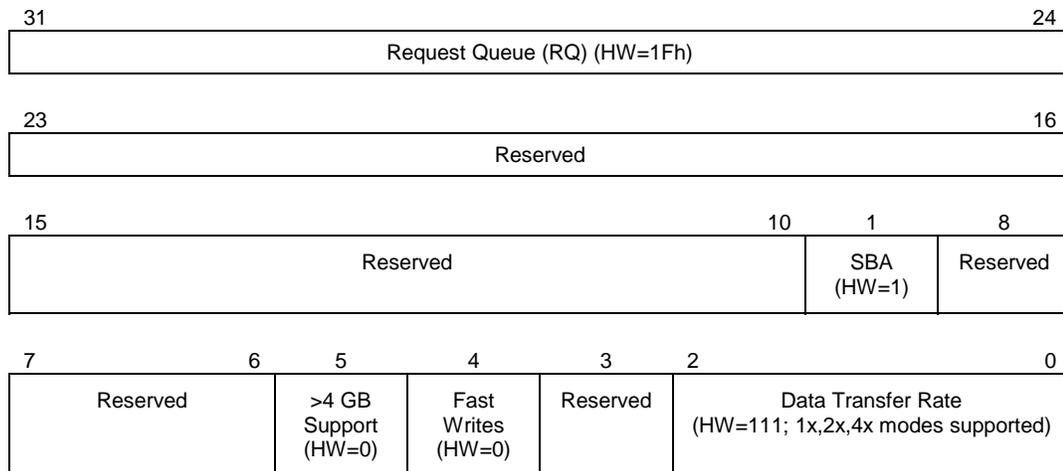

Bit	Description
31:24	<p>Request Queue (RQ). This field is hardwired to 1Fh to indicate a maximum of 32 outstanding AGP command requests can be handled by the GMCH. This field contains the maximum number of AGP command requests the GMCH is configured to manage. The lower 6 bits of this field reflect the value programmed in AGPCTRL[12:10]. Only discrete values of 32, 16, 8, 4, 2 and 1 can be selected via AGPCTRL. Upper bits are hardwired to 0.</p> <p>Default =1Fh to allow a maximum of 32 outstanding AGP command requests.</p>
23:10	Reserved
9	<p>SideBand Addressing (SBA). Indicates the GMCH supports sideband addressing. Hardwired to 1.</p>
8:6	Reserved
5	<p>Greater Than 4 GB Address Support (4GB). This bit indicates that the GMCH does not support addresses greater than 4 GB. It is hardwired to 0.</p>
4	<p>Fast Writes (FW). This bit indicates that the GMCH does not support Fast Writes from the processor to the AGP master. It is hardwired to a 0.</p>
3	Reserved
2:0	<p>Data Transfer Rate Capability (RATE). After reset the GMCH reports its data transfer rate capability. Note that the selected data transfer mode applies to both AD bus and SBA bus.</p> <p>Bit 0 = 1 = 1x data transfer mode Bit 1 = 1 = 2x data transfer mode Bit 2 = 1 = 4x data transfer mode. This bit can be masked by the AGPCTRL register bit 0 (AGP 4X Override).</p> <p>1x, 2x, and 4x data transfer modes are supported by the GMCH; therefore, this bit field has a Default Value = 111.</p>

3.4.30. AGPCMD—AGP Command Register (Device 0: AGP Mode Only)

Address Offset: A8–Abh
 Default Value: 00000000h
 Access: Read/Write
 Size: 32 bits

This register provides control of the AGP operational parameters.

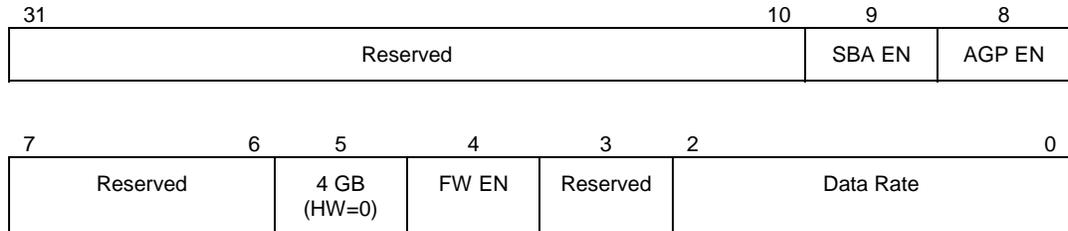

Bit	Description
31:10	Reserved.
9	Sideband Address Enable (SBA). 1 = Enable. The sideband addressing mechanism is enabled. 0 = Disable
8	AGP Enable. When this bit is reset to 0, the GMCH ignores all AGP operations, including the sync cycle. Any AGP operations received while this bit is set to 1 will be serviced, even if this bit is reset to 0. If this bit transitions from a 1 to a 0 on a clock edge in the middle of an SBA command being delivered in 1X mode, the command is issued. When this bit is set to 1 the GMCH will respond to AGP operations delivered via PIPE#, or to operations delivered via SBA, if the AGP Side Band Enable bit is also set to 1.
7:6	Reserved.
5	Greater Than 4 GB Support (4GB). Hardwired to 0. The GMCH as an AGP target does not support addressing greater than 4 GB.
4	Fast Writes Enable (FW). This bit must always be programmed to 0. The chipset will behave unpredictably if this bit is programmed with 1.
3	Reserved.
2:0	Data Rate Capability. The settings of these bits determines the AGP data transfer rate. One (<i>and only one</i>) bit in this field must be set to indicate the desired data transfer rate. The same bit must be set on both master and target. Configuration software will update this field by setting only one bit that corresponds to the capability of AGP master (after that capability has been verified by accessing the same functional register within the AGP master's configuration space.) Bit 0 = 1 = 1X Bit 1 = 1 = 2X Bit 2 = 1 = 4x Bit 2 becomes reserved (but will still read 4x, erroneously) when the 4x Override bit in the AGP CTRL register is set to 1 because this bit will not be updated in 4x Override mode. When the 4x Override bit is set writes to Data Rate[2] have no functional impact. Note: This field applies to AD and SBA buses.

3.4.31. AGPCTRL—AGP Control Register (Device 0: AGP Mode Only)

Address Offset: B0–B3h
 Default Value: 00000000h
 Access: Read/Write
 Size: 32 bits

This register provides for additional control of the AGP interface.

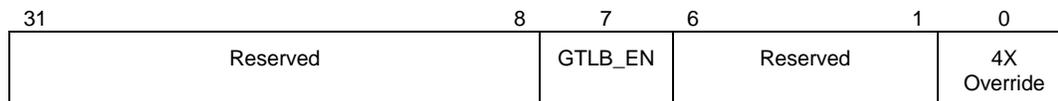

Bit	Description
31:8	Reserved
7	<p>GTLB Enable (and GTLB Flush Control)—R/W.</p> <p>1 = Enables normal operations of the Graphics Translation Lookaside Buffer.</p> <p>0 = Disable (default). The GTLB is flushed by clearing the valid bits associated with each entry. In this mode of operation all accesses that require translation bypass the GTLB. All requests that are positively decoded to the graphics aperture force the GMCH to access the translation table in main memory before completing the request. Translation table entry fetches are not cached in the GTLB.</p> <p>NOTE:</p> <ul style="list-style-type: none"> • When an invalid translation table entry is read, this entry is still cached in the GTLB (ejecting the least recently used entry). • The GMCH flushes the GTLB when software sets or clears this bit to ensure coherency between the GTLB and main memory. • This bit can be changed dynamically (i.e., while an access to GTLB occurs).
6:1	Reserved
0	<p>4X Override. When this bit is set to 1 the Rate[2] bit in the AGPSTAT register will be read as a 0. This "back-door" register bit allows BIOS to disable AGP 4X mode.</p> <p>The introduction of universal AGP cards and universal motherboards has raised some potential problems that this bit alleviates. AGP 2X can operation at 1.5V or 3.3V. AGP 4X can operate only at 1.5V. In a system that is supporting 3.3V operation, and therefore cannot support a 4X transfer rate, it is the responsibility of the BIOS to make sure that 4X mode is not selected.</p>

3.4.32. APSIZE—Aperture Size (Device 0: AGP Mode Only)

Address Offset: B4h
 Default Value: 00h
 Access: Read/Write
 Size: 8 bits

This register determines the effective size of the graphics aperture used for a particular GMCH configuration. This register can be updated by the GMCH-specific BIOS configuration sequence before the PCI standard bus enumeration sequence takes place. If the register is not updated, a default value will select an aperture of maximum size (i.e., 64 MB).

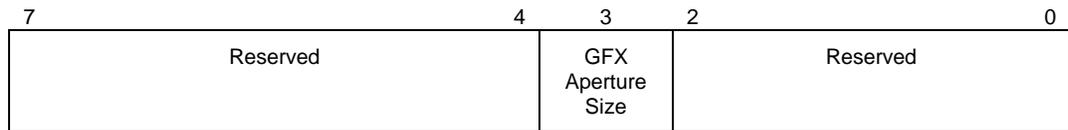

Bit	Description
7:4	Reserved.
3	<p>Graphics Aperture Size (GASIZE). Bit 3 operates on bit 25 of the Aperture Base (APBASE) configuration register. When this bit is 0, it forces bit 25 in APBASE to behave as “hardwired” to 0. When this bit is 1, it forces bit 25 in APBASE to be read/write accessible. Only the following combinations are allowed:</p> <p>0 = 64 MB Aperture Size 1 = 32 MB Aperture Size</p> <p>Default for APSIZE[3]=0b forces default APBASE[25] =0b (responds as “hardwired” to 0). This provides maximum aperture size of 64 MB. Programming APSIZE[3]=1b enables APBASE[25] as read/write programmable.</p>
2:0	Reserved.

3.4.33. ATTBASE—Aperture Translation Table Base Register (Device 0: AGP Mode Only)

Address Offset:	B8–BBh
Default Value:	00000000h
Access:	Read/Write
Size:	32 bits

This register provides the starting address of the Graphics Aperture Translation Table Base located in the main DRAM. This value is used by the GMCH's Graphics Aperture address translation logic (including the GTLB logic) to obtain the appropriate address translation entry required during the translation of the aperture address into a corresponding physical DRAM address. The ATTBASE register may be dynamically changed.

Note: The address provided via ATTBASE is 4 KB aligned.



Bit	Description
31:29	Reserved.
28:12	ATT Base Address. This field contains a pointer to the base of the translation table used to map memory space addresses in the aperture range to addresses in main memory.
11:0	Reserved.

3.4.34. AMTT—AGP Multi-Transaction Timer (Device 0: AGP Mode Only)

Address Offset: BCh
 Default Value: 00h
 Access: Read/Write
 Size: 8 bits

AMTT controls the amount of time that the GMCH’s arbiter allows AGP/PCI master to perform multiple back-to-back transactions. The GMCH’s AMTT mechanism is used to optimize the performance of the AGP master (using PCI semantics) that performs multiple back-to-back transactions to fragmented memory ranges (and as a consequence it can not use long burst transfers). The AMTT mechanism applies to the processor — AGP/PCI transactions as well and it guarantees to the processor a fair share of the AGP/PCI interface bandwidth.

The number of clocks programmed in the AMTT represents the guaranteed time slice (measured in 66 MHz clocks) allotted to the current agent (either AGP/PCI master or Host bridge) after which the AGP arbiter grants the bus to another agent. The default value of AMTT is 00h and disables this function. The AMTT value can be programmed with 8-clock granularity. For example, if the AMTT is programmed to 18h, the selected value corresponds to the time period of 24 AGP (66 MHz) clocks.

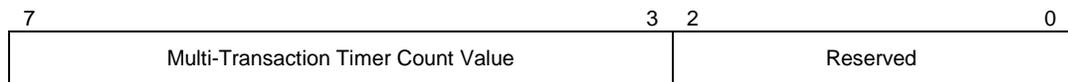

Bit	Description
7:3	Multi-Transaction Timer Count Value. The number programmed in these bits represents the guaranteed time slice (measured in eight 66 MHz clock granularity) allotted to the current agent (either AGP/PCI master or Host bridge) after which the AGP arbiter will grant the bus to another agent.
2:0	Reserved.

3.4.35. LPTT—AGP Low Priority Transaction Timer Register (Device 0: AGP Mode Only)

Address Offset:	BDh
Default Value:	00h
Access:	Read/Write
Size:	8 bits

LPTT is similar in function to AMTT. This register is used to control the minimum tenure on the AGP for low priority data transaction (both reads and writes) issued using PIPE# or SB mechanisms.

The number of clocks programmed in the LPTT represents the guaranteed time slice (measured in 66 MHz clocks) allotted to the current low priority AGP transaction data transfer state. This does not necessarily apply to a single transaction but it can span over multiple low-priority transactions of the same type. After this time expires, the AGP arbiter may grant the bus to another agent if there is a pending request. The LPTT does not apply in the case of high-priority request where ownership is transferred directly to high-priority requesting queue. The default value of LPTT is 00h and disables this function. The LPTT value can be programmed with 8-clock granularity. For example, if the LPTT is programmed to 10h, the selected value corresponds to the time period of 16 AGP (66 MHz) clocks.

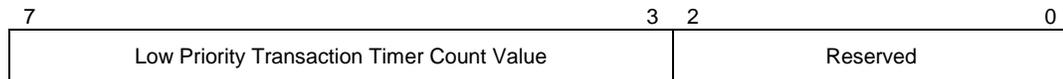

Bit	Description
7:3	Low Priority Transaction Timer Count Value. The number of clocks programmed in these bits represents the guaranteed time slice (measured in eight 66 MHz clock granularity) allotted to the current low priority AGP transaction data transfer state.
2:0	Reserved.

3.4.36. GMCHCFG—GMCH Configuration Register (Device 0: AGP Mode Only)

Address Offset: BEh
 Default: 0000 X000b
 Access: Read/Write, Read-Only
 Size: 8 bits

7	6	5	4	3	2	0
Reserved	Reserved	MDA Present (R/W)	Reserved	AGP_BUF Mode (RO)	Reserved	Reserved

Bit	Description															
7:6	Reserved.															
5	<p>MDA Present (MDAP)—R/W. This bit works with the VGA Enable bit in the BCTRL register (3Eh, bit 3) of device 1 to control the routing of processor-initiated transactions targeting MDA compatible I/O and memory address ranges. This bit should not be set when the VGA Enable bit is not set. If the VGA enable bit is set, accesses to IO address range x3BCh–x3BFh are forwarded to the hub interface. If the VGA enable bit is not set, accesses to IO address range x3BCh–x3BFh are treated just like any other IO accesses (i.e., the cycles are forwarded to AGP if the address is within IOBASE and IOLIMIT, and the ISA enable bit is not set; otherwise, they are forwarded to the hub interface). MDA resources are defined as the following:</p> <ul style="list-style-type: none"> • Memory: 0B0000h–0B7FFFh • I/O: 3B4h, 3B5h, 3B8h, 3B9h, 3BAh, 3BFh, (including ISA address aliases, A[15:10] are not used in decode) <p>Any I/O reference that includes the I/O locations listed above, or their aliases, will be forwarded to the hub interface, even if the reference includes I/O locations not listed above.</p> <p>The following table shows the behavior for all combinations of MDA and VGA:</p> <table style="margin-left: 40px;"> <thead> <tr> <th>VGA</th> <th>MDA</th> <th>Behavior</th> </tr> </thead> <tbody> <tr> <td style="text-align: center;">0</td> <td style="text-align: center;">0</td> <td>All references to MDA and VGA go to hub interface</td> </tr> <tr> <td style="text-align: center;">0</td> <td style="text-align: center;">1</td> <td>Illegal combination (DO NOT USE)</td> </tr> <tr> <td style="text-align: center;">1</td> <td style="text-align: center;">0</td> <td>All references to VGA go to AGP/PCI. MDA-only references (I/O address 3BFh and aliases) will go to the hub interface.</td> </tr> <tr> <td style="text-align: center;">1</td> <td style="text-align: center;">1</td> <td>VGA references go to AGP/PCI; MDA references go to the hub interface.</td> </tr> </tbody> </table>	VGA	MDA	Behavior	0	0	All references to MDA and VGA go to hub interface	0	1	Illegal combination (DO NOT USE)	1	0	All references to VGA go to AGP/PCI. MDA-only references (I/O address 3BFh and aliases) will go to the hub interface.	1	1	VGA references go to AGP/PCI; MDA references go to the hub interface.
VGA	MDA	Behavior														
0	0	All references to MDA and VGA go to hub interface														
0	1	Illegal combination (DO NOT USE)														
1	0	All references to VGA go to AGP/PCI. MDA-only references (I/O address 3BFh and aliases) will go to the hub interface.														
1	1	VGA references go to AGP/PCI; MDA references go to the hub interface.														
4	Reserved.															
3	<p>AGP I/O Buffer Mode (AGP_BUF)—RO. The GMCH has an internal circuit that detects the voltage level on the AGP I/O buffer VDDQ rail. The voltage level information is latched 500 us after the deasserting edge of RSTIN# and stored in this register bit.</p> <p>1 = AGP VDDQ is sensed at 3.3V. 0 = AGP VDDQ is sensed at 1.5V.</p>															
2:0	Reserved.															

3.4.37. ERRCMD—Error Command Register (Device 0: AGP Mode Only)

Address Offset: CBh
 Default Value: 00h
 Access: Read/Write
 Size: 8 bits

This register enables various errors to generate a SERR hub interface special cycle. Since the GMCH does not have an SERR# signal, SERR messages are passed from the GMCH to the I/O Controller Hub over the hub interface. The actual generation of the SERR message is globally enabled for Device 0 via the PCI Command register.

Note: An error can generate one and only one hub interface error special cycle. It is software's responsibility to make sure that when an SERR error message is enabled for an error condition, SMI and SCI error messages are disabled for that same error condition.

7	6	5	4	3	2	1	0
Reserved	SRMMRO	SRTA	SLNDM	SAAOGA	SIAA	SAIGATTE	

Bit	Description
7:6	Reserved.
5	<p>SERR on Receiving Main Memory Refresh Overrun Enable. Identical functionality in Device 2 memory mapped space @ 020B8h. This bit allows use of this same functionality in AGP Mode.</p> <p>1 = Enable. GMCH generates a SERR hub interface special cycle when a main memory refresh overrun occurs.</p> <p>0 = Disable. Reporting of this condition is disabled.</p>
4	<p>SERR on Receiving Target Abort on the hub interface.</p> <p>1 = Enable. GMCH generates a SERR hub interface special cycle when a GMCH-originated hub interface cycle is terminated with a Target Abort.</p> <p>0 = Disable. Reporting of this condition is disabled.</p>
3	<p>SERR on LOCK to non-DRAM Memory.</p> <p>1 = Enable. GMCH generates a SERR hub interface special cycle when a processor-initiated LOCK transaction targeting non-DRAM memory space occurs.</p> <p>0 = Disable. Reporting of this condition is disabled.</p>
2	<p>SERR on AGP Access Outside of Graphics Aperture.</p> <p>1 = Enable. GMCH generates a SERR hub interface special cycle when an AGP access occurs to an address outside of the graphics aperture.</p> <p>0 = Disable. Reporting of this condition is disabled.</p>
1	<p>SERR on Invalid AGP Access.</p> <p>1 = Enable. GMCH generates a SERR hub interface special cycle when an AGP access occurs to an address outside of the graphics aperture and either to the 640 KB–1 MB range or above the top of memory.</p> <p>0 = Disable.</p>
0	<p>SERR on Access to Invalid Graphics Aperture Translation Table Entry.</p> <p>1 = Enable. GMCH generates a SERR hub interface special cycle when an invalid translation table entry was returned in response to a AGP access to the graphics aperture.</p> <p>0 = Disable. Reporting of this condition via SERR messaging is disabled.</p>

Table 6. Summary of GMCH Error Sources, Enables and Status Flags

Error Event	Hub Interface Message	Enable Bits Required to be Set	Status Flags Set
Processor LOCK to non-DRAM memory	SERR	PCICMD bit 8 ERRCMD bit 3	PCISTS bit 14
Received Hub Interface Target Abort	SERR	PCICMD bit 8 ERRCMD bit 4	PCISTS bit 14 PCISTS bit 12
AGP Access Outside of Graphics Aperture	SERR	PCICMD bit 8 ERRCMD bit 2	PCISTS bit 14
Invalid AGP Access	SERR	PCICMD bit 8 ERRCMD bit 1	PCISTS bit 14
Access to Invalid GTLB Entry	SERR	PCICMD bit 8 ERRCMD bit 0	PCISTS bit 14
AGP/PCI Parity Error Detected	SERR	PCICMD1 bit 8 BCTRL bit 2	PCISTS1 bit 14 PCISTS1 bit 15
AGP/PCI Received Target Abort	SERR	PCICMD1 bit 8 ERRCMD1 bit 0	PCISTS1 bit 14 PCISTS1 bit 12

3.5. AGP/PCI Bridge Registers (Device 1: Visible in AGP Mode Only)

These registers are accessible through the configuration mechanism defined in an earlier section of this document.

Table 7. GMCH Configuration Space (Device 1)

Address Offset	Mnemonic	Register Name	Default Value	Access Type
00–01h	VID1	Vendor Identification	8086h	RO
02–03h	DID1	Device Identification	1131h	RO
04–05h	PCICMD1	PCI Command	0000h	RO, R/W
06–07h	PCISTS1	PCI Status	0020h	RO, R/WC
08	RID1	Revision Identification	02h (see note)	RO
09	—	Reserved	00h	—
0Ah	SUBC1	Sub-Class Code	04h	RO
0Bh	BCC1	Base Class Code	06h	RO
0Ch	—	Reserved	00h	—
0Dh	MLT1	Master Latency Timer	00h	R/W
0Eh	HDR1	Header Type	01h	RO
0F–17h	—	Reserved	00h	—
18h	PBUSN	Primary Bus Number	00h	RO
19h	SBUSN	Secondary Bus Number	00h	R/W
1Ah	SUBUSN	Subordinate Bus Number	00h	R/W
1Bh	SMLT	Secondary Bus Master Latency Timer	00h	R/W
1Ch	IOBASE	I/O Base Address	F0h	R/W
1Dh	IOLIMIT	I/O Limit Address	00h	R/W
1E–1Fh	SSTS	Secondary Status	02A0h	RO, R/WC
20–21h	MBASE	Memory Base Address	FFF0h	R/W
22–23h	MLIMIT	Memory Limit Address	0000h	R/W
24–25h	PMBASE	Prefetchable Memory Base Address	FFF0h	R/W
26–27h	PMLIMIT	Prefetchable Memory Limit Address	0000h	R/W
28–3Dh	—	Reserved	00h	—
3Eh	BCTRL	Bridge Control	00h	R/W
3Fh	—	Reserved	00h	—
40h	ERRCMD1	Error Command	00h	R/W
41–FFh	—	Reserved	00h	—

Note: See Specification Update document for latest information.

3.5.1. VID1—Vendor Identification Register (Device 1)

Address Offset:	00–01h
Default Value:	8086h
Attribute:	Read-Only
Size:	16 bits

The VID1 Register contains the vendor identification number. This 16-bit register combined with the Device Identification Register uniquely identify any PCI device. Writes to this register have no effect.

Bit	Description
15:0	Vendor Identification Number. This is a 16-bit value assigned to Intel. Intel VID = 8086h.

3.5.2. DID1—Device Identification Register (Device 1)

Address Offset:	02–03h
Default Value:	1131h
Attribute:	Read-Only
Size:	16 bits

This 16-bit register combined with the Vendor Identification register uniquely identifies any PCI device. Writes to this register have no effect.

Bit	Description
15:0	Device Identification Number. This is a 16 bit value assigned to the GMCH AGP interface device. 1131h = Device ID for Device 1.

3.5.3. PCICMD1—PCI-PCI Command Register (Device 1)

Address Offset:	04–05h
Default:	0000h
Access:	Read/Write, Read-Only
Size	16 bits

15										10		9	8
Reserved (0)										FB2B (Not Impl)		SERR En	
7		6	5	4	3	2	1	0					
Addr/Data Stepping (Not Impl)		Parity Error En (Not Impl)	Reserved	Mem WR & Inval En (Not Impl)	Special Cycle En (Not Impl)	Bus Master En	Mem Acc En	I/O Acc En					

Bit	Descriptions
15:10	Reserved.
9	Fast Back-to-Back. (Not Applicable). Hardwired to 0.
8	<p>SERR Message Enable (SERRE1). This bit is a global enable bit for Device 1 SERR messaging. The GMCH does not have an SERR# signal. The GMCH communicates the SERR# condition by sending an SERR message to the I/O Controller Hub. If this bit is set to a 1, the GMCH is enabled to generate SERR messages over the hub interface for specific Device 1 error conditions that are individually enabled in the ERRCMD1 and BCTRL registers. The error status is reported in the PCISTS1 register. If SERRE1 is reset to 0, the SERR message is not generated by the GMCH for Device 1.</p> <p>1 = Enable. 0 = Disable.</p> <p>NOTE: This bit only controls SERR messaging for the Device 1. Device 0 has its own SERRE bit to control error reporting for error conditions occurring on Device 0. The two control bits are used in a logical OR manner to enable the SERR hub interface message mechanism.</p>
7	Address/Data Stepping. (Not Applicable). Hardwired to 0.
6	Parity Error Enable (PERRE1). Hardwired to 0. PERR# is not supported on AGP/PCI1.
5	Reserved.
4	Memory Write and Invalidate Enable—RO. This bit is implemented as read-only and returns a value of 0 when read.
3	Special Cycle Enable—RO. This bit is implemented as read-only and returns a value of 0 when read.
2	<p>Bus Master Enable (BME1)—R/W.</p> <p>1 = Enable. AGP Master-initiated FRAME# cycles are accepted by the GMCH if they hit a valid address decode range. This bit has no affect on AGP Master originated SBA or PIPE# cycles.</p> <p>0 = Disable (default). AGP Master-initiated FRAME# cycles are ignored by the GMCH resulting in a Master Abort. Ignoring incoming cycles on the secondary side of the P2P bridge effectively disables the bus master on the primary side.</p>
1	<p>Memory Access Enable (MAE1)—R/W.</p> <p>1 = Enable. Enables the Memory and Prefetchable memory address ranges defined in the MBASE, MLIMIT, PMBASE, and PMLIMIT registers, as well as the VGA window.</p> <p>0 = Disable. All of the memory space for Device 1 is disabled.</p>
0	<p>I/O Access Enable (IOAE1)—R/W.</p> <p>1 = Enable. Enables the I/O address range defined in the IOBASE and IOLIMIT registers.</p> <p>0 = Disable. All of I/O space for Device 1 is disabled.</p>

3.5.4. PCISTS1—PCI-PCI Status Register (Device 1)

Address Offset: 06–07h
 Default Value: 0020h
 Access: Read-Only, Read/Write Clear
 Size: 16 bits

PCISTS1 reports the occurrence of error conditions associated with the primary side of the “virtual” PCI-PCI bridge embedded in the GMCH. Since this device does not physically reside on PCI0, it reports the optimum operating conditions so that it does not restrict the capability of PCI0.

15	14	13	12	11	10	9	8
Detected Par Error (HW=0)	Sig Sys Error	Recog Mast Abort Sta (HW=0)	Rec Target Abort Sta (HW=0)	Sig Target Abort Sta (HW=0)	DEVSEL# Timing (HW=00)		Data Par Detected (HW=0)
7	6	5	4	3			0
FB2B (HW=1)	Reserved		Cap List (HW=1)	Reserved			

Bit	Descriptions
15	Detected Parity Error (DPE1). (Not Applicable). Hardwired to 0.
14	Signaled System Error (SSE1). 1 = GMCH Device 1 generated an SERR message over hub interface for any enabled Device 1 error condition. Device 1 error conditions are enabled in the PCICMD1, ERRCMD1 and BCTRL registers. Device 1 error flags are read/reset from the SSTS register. 0 = Software clears this bit by writing a 1 to it.
13	Received Master Abort Status (RMAS1). (Not Applicable). Hardwired to 0.
12	Received Target Abort Status (RTAS1). (Not Applicable). Hardwired to 0.
11	Signaled Target Abort Status (STAS1). (Not Applicable). Hardwired to 0.
10:9	DEVSEL# Timing (DEVT1). (Not Applicable). Hardwired to 00b.
8	Data Parity Detected (DPD1). (Not Applicable). Hardwired to 0.
7	Fast Back-to-Back (FB2B1). (Not Applicable). Hardwired to 0.
6	Reserved.
5	66/60 MHz Capability. (Not Applicable). Hardwired to 1.
4:0	Reserved.

3.5.5. RID1—Revision Identification Register (Device 1)

Address Offset:	08h
Default Value:	02h (see Spec. Update document for latest information.)
Access:	Read-Only
Size:	8 bits

This register contains the revision number of the GMCH Device 1. These bits are read-only and writes to this register have no effect.

Bit	Description
7:0	Revision Identification Number. This 8-bit value indicates the revision identification number for the GMCH Device 1. 02h = A-2 Stepping

3.5.6. SUBC1—Sub-Class Code Register (Device 1)

Address Offset:	0Ah
Default Value:	04h
Access:	Read-Only
Size:	8 bits

This register contains the Sub-Class Code for the GMCH Device 1. This code is 04h indicating a PCI-PCI Bridge device. The register is read-only.

Bit	Description
7:0	Sub-Class Code (SUBC1). This 8-bit value indicates the category of Bridge of the GMCH. 04h = Host Bridge.

3.5.7. BCC1—Base Class Code Register (Device 1)

Address Offset:	0Bh
Default Value:	06h
Access:	Read-Only
Size:	8 bits

This register contains the Base Class Code of the GMCH Device 1. This code is 06h indicating a Bridge device. This register is read-only.

Bit	Description
7:0	Base Class Code (BASEC). This 8-bit value indicates the Base Class Code for the GMCH Device 1. 06h = Bridge device.

3.5.8. MLT1—Master Latency Timer Register (Device 1)

Address Offset:	0Dh
Default Value:	00h
Access:	Read/Write
Size:	8 bits

This functionality is not applicable. It is described here since these bits should be implemented as a read/write to prevent standard PCI-PCI bridge configuration software from getting “confused”.

Bit	Description
7:3	Not applicable but supports read/write operations. (Reads return previously written data.)
2:0	Reserved.

3.5.9. HDR1—Header Type Register (Device 1)

Address Offset:	0Eh
Default:	01h
Access:	Read-Only
Size:	8 bits

This register identifies the header layout of the configuration space. No physical register exists at this location.

Bit	Descriptions
7:0	This read-only field always returns 01h when read. Writes have no effect.

3.5.10. PBUSN—Primary Bus Number Register (Device 1)

Address Offset:	18h
Default:	00h
Access:	Read-Only
Size:	8 bits

This register identifies that the “virtual” PCI-PCI bridge is connected to bus #0.

Bit	Descriptions
7:0	Bus Number. Hardwired to 0.

3.5.11. SBUSN—Secondary Bus Number Register (Device 1)

Address Offset:	19h
Default:	00h
Access:	Read /Write
Size:	8 bits

This register identifies the bus number assigned to the second bus side of the “virtual” PCI-PCI bridge (i.e., to PCI1/AGP). This number is programmed by the PCI configuration software to allow mapping of configuration cycles to PCI1/AGP.

Bit	Descriptions
7:0	Bus Number. Programmable

3.5.12. SUBUSN—Subordinate Bus Number Register (Device 1)

Address Offset:	1Ah
Default:	00h
Access:	Read /Write
Size:	8 bits

This register identifies the subordinate bus (if any) that resides at the level below PCI1/AGP. This number is programmed by the PCI configuration software to allow mapping of configuration cycles to PCI1/AGP.

Bit	Descriptions
7:0	Bus Number. Programmable

3.5.13. SMLT—Secondary Master Latency Timer Register (Device 1)

Address Offset: 1Bh
 Default Value: 00h
 Access: Read/Write
 Size: 8 bits

This register controls the bus tenure of the GMCH on AGP/PCI. SMLT is an 8-bit register that controls the amount of time the GMCH, as a AGP/PCI bus master, can burst data on the AGP/PCI Bus. The count value is an 8-bit quantity; however, SMLT[2:0] are reserved and assumed to be 0 when determining the count value. The GMCH’s SMLT is used to guarantee to the AGP master a minimum amount of the system resources. When the GMCH begins the first PCI bus cycle after being granted the bus, the counter is loaded and enabled to count from the assertion of FRAME#. If the count expires while the GMCH’s grant is removed (due to AGP master request), the GMCH will lose the use of the bus and the AGP master agent may be granted the bus. If the GMCH’s bus grant is not removed, the GMCH continues to own the AGP/PCI bus, regardless of the SMLT expiration or idle condition. Note that the GMCH must always properly terminate a AGP/PCI transaction, with FRAME# negation prior to the final data transfer.

The number of clocks programmed in the SMLT represents the guaranteed time slice (measured in 66 MHz PCI clocks) allotted to the GMCH, after which it must complete the current data transfer phase and then surrender the bus as soon as its bus grant is removed. For example, if the SMLT is programmed to 18h, the value is 24 AGP clocks. The default value of SMLT is 00h and disables this function. When the SMLT is disabled, the burst time for the GMCH is unlimited (i.e., the GMCH can burst forever).

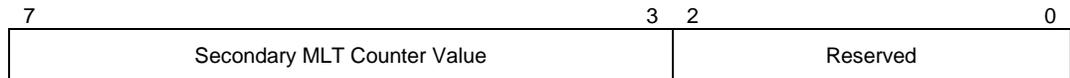

Bit	Description
7:3	Secondary MLT Counter Value. Default=0 (i.e., SMLT disabled)
2:0	Reserved.

3.5.14. IOBASE—I/O Base Address Register (Device 1)

Address Offset: 1Ch
 Default Value: F0h
 Access: Read/Write
 Size: 8 bits

This register control the processor to PCI1/AGP I/O access routing based on the following formula:

$$\text{IO_BASE} \leq \text{address} \leq \text{IO_LIMIT}$$

Only the upper 4 bits are programmable. For the purpose of address decode, address bits A[11:0] are treated as 0. Thus, the bottom of the defined I/O address range will be aligned to a 4-KB boundary.

Note: BIOS must not set this register to 00h; otherwise, 0CF8h/0CFCh accesses will be forwarded to AGP.

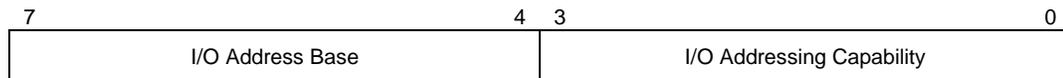

Bit	Description
7:4	I/O Address Base. Corresponds to A[15:12] of the I/O address. (Default=Fh)
3:0	I/O Addressing Capability. Hardwired to 0h indicating that only 16 bit I/O addressing is supported. Bits [31:16] of the I/O base address are assumed to be 0000h.

3.5.15. IOLIMIT—I/O Limit Address Register (Device 1)

Address Offset: 1Dh
 Default Value: 00h
 Access: Read/Write
 Size: 8 bits

This register controls the processor to PCI1/AGP I/O access routing based on the following formula:

$$IO_BASE \leq address \leq IO_LIMIT$$

Only upper 4 bits are programmable. For the purpose of address decode address bits A[11:0] are assumed to be FFFh. Thus, the top of the defined I/O address range will be at the top of a 4-KB aligned address block.

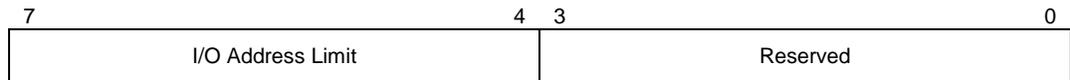

Bit	Description
7:4	I/O Address Limit. Corresponds to A[15:12] of the I/O address. (Default=0)
3:0	Reserved. (Only 16 bit addressing supported.)

3.5.16. SSTS—Secondary PCI-PCI Status Register (Device 1)

Address Offset:	1E–1Fh
Default Value:	02A0h
Access:	Read-Only, Read/Write Clear
Size:	16 bits

SSTS is a 16-bit status register that reports the occurrence of error conditions associated with the secondary side (i.e., PCI1/AGP side) of the “virtual” PCI-PCI bridge embedded within GMCH.

15	14	13	12	11	10	9	8
Det. Parity Error	Rec Sys Error (HW=0)	Rec Master Abort	Rec Target Abort	Sig Target Abort (HW=0)	DEVSEL Timing (HW=01b; medium)	Data Parity Det. (HW=0)	
7	6	5	4	0			
FB2B (HW=1)	Reserved	66/60 MHz Cap (HW=1)	Reserved				

Bit	Descriptions
15	<p>Detected Parity Error (DPE1). Note that the function of this bit is not affected by the PERRE1 bit. Also note that PERR# is not implemented in the GMCH.</p> <p>1 = GMCH detected a parity error in the address or data phase of PCI1/AGP bus transactions.</p> <p>0 = Software sets DPE1 to 0 by writing a 1 to this bit.</p>
14	<p>Received System Error (SSE1). Hardwired to 0. The GMCH does not have an SERR# signal pin.</p>
13	<p>Received Master Abort Status (RMAS1).</p> <p>1 = GMCH terminated a Host-to-PCI1/AGP with an unexpected master abort.</p> <p>0 = Software resets this bit to 0 by writing a 1 to it.</p>
12	<p>Received Target Abort Status (RTAS1).</p> <p>1 = GMCH-initiated transaction on PCI1/AGP is terminated with a target abort.</p> <p>0 = Software resets RTAS1 to 0 by writing a 1 to it.</p>
11	<p>Signaled Target Abort Status (STAS1). Hardwired to 0. The GMCH does not generate target abort on PCI1/AGP.</p>
10:9	<p>DEVSEL# Timing (DEVT1). This 2-bit field indicates the timing of the DEVSEL# signal when the GMCH responds as a target on PCI1/AGP, and is hard-wired to the value 01b (medium) to indicate the time when a valid DEVSEL# can be sampled by the initiator of the PCI cycle.</p>
8	<p>Data Parity Detected (DPD1). Hardwired to 0. GMCH does not implement G_PERR# function. However, data parity errors are still detected and reported using SERR hub interface special cycles (if enabled by SERRE1 and the BCTRL register, bit 0).</p>
7	<p>Fast Back-to-Back (FB2B1). Hardwired to 1. The GMCH as a target supports fast back-to-back transactions on PCI1/AGP.</p>
6	Reserved.
5	66/60 MHz Capability. Hardwired to 1.
4:0	Reserved.

3.5.18. MLIMIT—Memory Limit Address Register (Device 1)

Address Offset:	22–23h
Default Value:	0000h
Access:	Read/Write
Size:	16 bits

This register controls the processor to PCI1 non-prefetchable memory access routing based on the following formula:

$$\text{MEMORY_BASE} \leq \text{address} \leq \text{MEMORY_LIMIT}$$

The upper 12 bits of the register are read/write and correspond to the upper 12 address bits A[31:20] of the 32 bit address. The bottom 4 bits of this register are read-only and return zeroes when read. The configuration software must initialize this register. For the purpose of address decode, address bits A[19:0] are assumed to be FFFFh. Thus, the top of the defined memory address range will be at the top of a 1 MB aligned memory block.



Bit	Description
15: 4	Memory Address Limit (MEM_LIMIT) . Corresponds to A[31:20] of the memory address. (Default=0)
3:0	Reserved.

Note: Memory range covered by MBASE and MLIMIT registers are used to map non-prefetchable PCI1/AGP address ranges (typically, where control/status memory-mapped I/O data structures of the graphics controller will reside) and PMBASE and PMLIMIT are used to map prefetchable address ranges (typically, graphics local memory). This segregation allows application of USWC space attribute to be performed in a true plug-and-play manner to the prefetchable address range for improved processor –AGP memory access performance.

Note: Configuration software is responsible for programming all address range registers (prefetchable, non-prefetchable) with the values that provide exclusive address ranges (i.e., prevent overlap with each other and/or with the ranges covered with the main memory). There is no provision in the GMCH hardware to enforce prevention of overlap and operations of the system in the case of overlap are not guaranteed.

3.5.19. PMBASE—Prefetchable Memory Base Address Register (Device 1)

Address Offset: 24–25h
 Default Value: FFF0h
 Access: Read/Write
 Size: 16 bits

This register controls the processor to PCI1 prefetchable memory accesses routing based on the following formula:

$$\text{PREFETCHABLE_MEMORY_BASE} \leq \text{address} \leq \text{PREFETCHABLE_MEMORY_LIMIT}$$

The upper 12 bits of the register are read/write and correspond to the upper 12 address bits A[31:20] of the 32 bit address. The bottom 4 bits of this register are read-only and return zeroes when read. The configuration software must initialize this register. For the purpose of address decode, address bits A[19:0] are assumed to be 0. Thus, the bottom of the defined memory address range will be aligned to a 1 MB boundary.

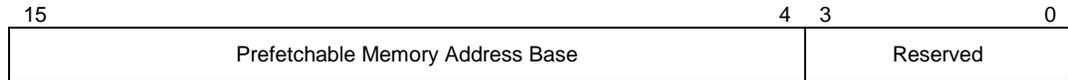

Bit	Description
15: 4	Prefetchable Memory Address Base(PMEM_BASE) . Corresponds to A[31:20] of the memory address. (Default=FFFh)
3:0	Reserved.



3.5.20. PMLIMIT—Prefetchable Memory Limit Address Register (Device 1)

Address Offset: 26–27h
 Default Value: 0000h
 Access: Read/Write
 Size: 16 bits

This register controls the processor to PCI1 prefetchable memory accesses routing based on the following formula.

$$\text{PREFETCHABLE_MEMORY_BASE} \leq \text{address} \leq \text{PREFETCHABLE_MEMORY_LIMIT}$$

The upper 12 bits of the register are read/write and correspond to the upper 12 address bits A[31:20] of the 32 bit address. The bottom 4 bits of this register are read-only and return zeroes when read. The configuration software must initialize this register. For the purpose of address decode, address bits A[19:0] are assumed to be FFFFh. Thus, the top of the defined memory address range will be at the top of a 1 MB aligned memory block.

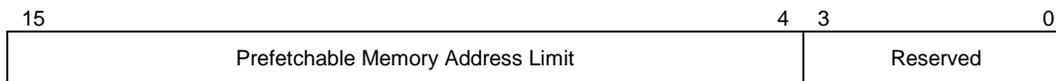

Bit	Description
15: 4	Prefetchable Memory Address Limit (PMEM_LIMIT) . Corresponds to A[31:20] of the memory address. (Default=0)
3:0	Reserved.

Note: Prefetchable memory range is supported to allow segregation by the configuration software between the memory ranges that must be defined as UC and the ones that can be designated as a USWC (i.e., prefetchable) from the processor perspective.

3.5.21. BCTRL—PCI-PCI Bridge Control Register (Device 1)

Address Offset: 3Eh
 Default: 00h
 Access: Read/Write
 Size: 8 bits

This register provides extensions to the PCICMD1 register that are specific to PCI-PCI bridges. The BCTRL provides additional control for the secondary interface (i.e., PCI1/AGP) as well as some bits that affect the overall behavior of the “virtual” PCI-PCI bridge embedded in GMCH (e.g., VGA compatible address ranges mapping).

7	6	5	4	3	2	1	0
FB2B EN	Sec Bus Reset	Reserved	Reserved	VGA EN		SERR# EN	Parity Err Response EN

Bit	Description
7	Fast Back to Back Enable. Hardwired to 0. Since there is only one target allowed on AGP, this bit is meaningless.
6	Secondary Bus Reset. Hardwired to 0. The GMCH does not support generation of reset via this bit on the AGP. Note that the only way to perform a hard reset of the AGP is via the system reset, either initiated by software or hardware via the I/O Controller Hub.
5	Master Abort Mode. Hardwired to 0. This means that when acting as a master on AGP/PCI1, the GMCH will drop writes on the “floor” and return all 1s during reads when a Master Abort occurs.
4	Reserved.

Bit	Description															
3	<p>VGA Enable. This bit works with the MDA present bit (GMCHCFG[3]) of device 0 to control the routing of processor-initiated transactions targeting VGA compatible I/O and memory address ranges. When this bit is set, the GMCH forwards the following processor accesses to the AGP:</p> <ul style="list-style-type: none"> • Memory accesses in the range 0A0000h to 0BFFFFh • I/O addresses where A[9:0] are in the ranges 3B0h to 3BBh and 3C0h to 3DFh (inclusive of ISA address aliases – A[15:10] are not decoded) <p>1 = Enable. Forwarding of these accesses issued by the processor is independent of the I/O address and memory address ranges defined by the previously defined Base and Limit registers. Forwarding of these accesses is also independent of the settings of bit 2 (ISA Enable) of this register if this bit is 1. If the VGA enable bit is set, accesses to IO address range x3BCh–x3BFh are forwarded to the hub interface. If the VGA enable bit is not set, accesses to IO address range x3BCh–x3BFh are treated just like any other IO accesses (i.e., cycles are forwarded to AGP, if the address is within IOBASE and IOLIMIT and ISA enable bit is not set; otherwise, they are forwarded to hub interface).</p> <p>0 = Disable (default). VGA compatible memory and I/O range accesses are not forwarded to AGP; rather, they are mapped to primary PCI unless they are mapped to AGP via I/O and memory range registers defined above (IOBASE, IOLIMIT, MBASE, MLIMIT, PMBASE, PMLIMIT).</p> <p>The following table shows the behavior for all combinations of MDA and VGA:</p> <table border="1" data-bbox="472 871 1377 1066"> <thead> <tr> <th>VGA</th> <th>MDA</th> <th>Behavior</th> </tr> </thead> <tbody> <tr> <td>0</td> <td>0</td> <td>All references to MDA and VGA Go To hub interface</td> </tr> <tr> <td>0</td> <td>1</td> <td>Illegal combination (DO NOT USE)</td> </tr> <tr> <td>1</td> <td>0</td> <td>All references To VGA Go To AGP MDA-only references (I/O Address 3BF and aliases) will go to hub interface.</td> </tr> <tr> <td>1</td> <td>1</td> <td>VGA references go to AGP/PCI; MDA references go to the hub interface</td> </tr> </tbody> </table>	VGA	MDA	Behavior	0	0	All references to MDA and VGA Go To hub interface	0	1	Illegal combination (DO NOT USE)	1	0	All references To VGA Go To AGP MDA-only references (I/O Address 3BF and aliases) will go to hub interface.	1	1	VGA references go to AGP/PCI; MDA references go to the hub interface
VGA	MDA	Behavior														
0	0	All references to MDA and VGA Go To hub interface														
0	1	Illegal combination (DO NOT USE)														
1	0	All references To VGA Go To AGP MDA-only references (I/O Address 3BF and aliases) will go to hub interface.														
1	1	VGA references go to AGP/PCI; MDA references go to the hub interface														
2	<p>ISA Enable. Modifies the response by the GMCH to an I/O access issued by the processor that targets ISA I/O addresses. This applies only to I/O addresses that are enabled by the IOBASE and IOLIMIT registers.</p> <p>1 = Enable. GMCH will not forward to PCI1/AGP any I/O transactions addressing the last 768 bytes in each 1 KB block, even if the addresses are within the range defined by the IOBASE and IOLIMIT registers. Instead of going to PCI1/AGP, these cycles are forwarded to the hub interface where they can eventually be subtractively or positively claimed by the ISA bridge.</p> <p>0 = Disable (default). All addresses defined by the IOBASE and IOLIMIT for processor I/O transactions are mapped to PCI1/AGP.</p>															
1	<p>SERR# Enable. Hardwired to 0. This bit normally controls forwarding SERR# on the secondary interface to the primary interface. The GMCH does not support the SERR# signal on the AGP/PCI1 bus.</p>															
0	<p>Parity Error Response Enable. Controls GMCH's response to data phase parity errors on PCI1/AGP. G_PERR# is not implemented by the GMCH.</p> <p>1 = Enable. Address and data parity errors on PCI1 are reported via SERR messaging, if enabled by SERRE1.</p> <p>0 = Disable. Address and data parity errors on PCI1/AGP are not reported via SERR messaging. Other types of error conditions can still be signaled via SERR messaging independent of this bit's state.</p>															

3.5.22. ERRCMD1—Error Command Register (Device 1)

Address Offset: 40h
 Default: 00h
 Access: Read/Write
 Size: 8 bits

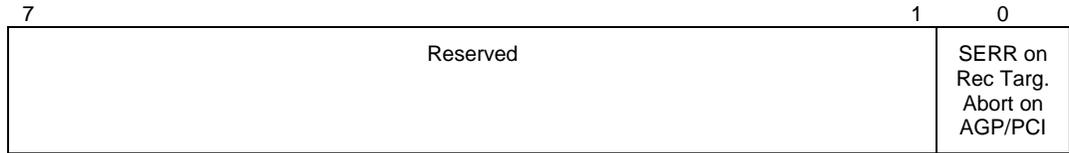

Bit	Descriptions
7:1	Reserved.
0	<p>SERR on Receiving Target Abort on AGP/PCI.</p> <p>1 = Enable. The GMCH generates an SERR hub interface special cycle when an GMCH-originated AGP/PCI cycle is terminated with a Target Abort.</p> <p>0 = Disable. Reporting of this condition is disabled.</p>

3.6. Graphics Device Registers (Device 2: VISIBLE IN GFX Mode Only)

These registers are accessible through the configuration mechanism defined in an earlier section of this document.

Table 8. Device 2 Configuration Space Address Map (Internal Graphics)

Address Offset	Register Symbol	Register Name	Default Value	Access Type
00–01h	VID2	Vendor Identification	8086h	RO
02–03h	DID2	Device Identification	1132h	RO
04–05h	PCICMD2	PCI Command	0004h	R/W
06–07h	PCISTS2	PCI Status	02B0h	RO
08h	RID2	Revision Identification	02h (see note)	RO
09h	PI	Programming Interface	00h	RO
0Ah	SUBC2	Sub-Class Code	00h	RO
0Bh	BCC2	Base Class Code	03h	RO
0Ch	CLS	Cache Line Size	00h	RO
0Dh	MLT2	Master Latency Timer	00h	RO
0Eh	HDR2	Header Type	01h	RO
0Fh	BIST	BIST Register	00h	RO
10–13h	GMADR	Graphics Memory Range Address	00000008h	R/W
14–17h	MMADR	Memory Mapped Range Address	00000000h	R/W
18–2Bh	—	Reserved	00h	—
2C–2Dh	SVID	Subsystem Vendor ID	0000h	R/WO
2E–2Fh	SID	Subsystem ID	0000h	R/WO
30–33h	ROMADR	Video Bios ROM Base Address	00000000h	RO
34h	CAPPOINT	Capabilities Pointer	DCh	RO
35–3Bh	—	Reserved	00h	—
3Ch	INTRLINE	Interrupt Line	00h	R/W
3Dh	INTRPIN	Interrupt Pin	01h	RO
3Eh	MINGNT	Minimum Grant	00h	RO
3Fh	MAXLAT	Maximum Latency	00h	RO
40–DBh	—	Reserved	00h	—
DC–DDh	PM_CAPID	Power Management Capabilities	0001h	RO
DE–DFh	PM_CAP	Power Management Capabilities	0022h	RO
E0–E1h	PM_CS	Power Management Control	0000h	R/W
E2–FFh	—	Reserved	00h	—

Note: See Specification Update document for latest information.

3.6.1. VID2—Vendor Identification Register (Device 2)

Address Offset: 00h–01h
 Default Value: 8086h
 Attribute: Read-Only
 Size: 16 bits

The VID Register contains the vendor identification number. This 16-bit register combined with the Device Identification Register uniquely identify any PCI device. Writes to this register have no effect.

Bit	Description
15:0	Vendor Identification Number. This 16-bit value is assigned to Intel.

3.6.2. DID2—Device Identification Register (Device 2)

Address Offset: 02h–03h
 Default Value: 1132h
 Attribute: Read-Only
 Size: 16 bits

This 16-bit register combined with the Vendor Identification register uniquely identifies any PCI device. Writes to this register have no effect.

Bit	Description
15:0	Device Identification Number. This 16 bit value is assigned to the internal graphics device of the GMCH. 1132h = Device ID for Device 2.

3.6.3. PCICMD2—PCI Command Register (Device 2)

Address Offset: 04h–05h
 Default: 0004h
 Access: Read-Only, Read/Write
 Size: 16 bits

This 16-bit register provides basic control over the chipset's ability to respond to PCI cycles. The PCICMD Register in the GMCH disables PCI compliant master accesses to main memory.

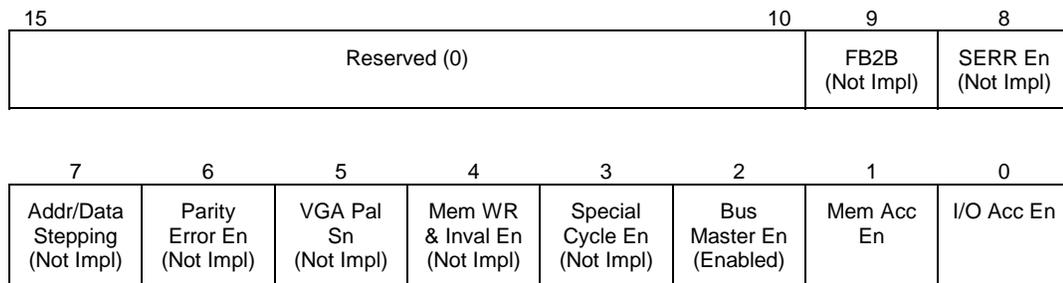

Bits	Description
15:10	Reserved.
9	Fast Back-to-Back (FB2B)—RO. (Not Implemented). Hardwired to 0.
8	SERR# Enable (SERRE)—RO. (Not Implemented). Hardwired to 0.
7	Address/Data Stepping—RO. (Not Implemented). Hardwired to 0.
6	Parity Error Enable (PERRE)—RO. (Not Implemented). Hardwired to 0. Since the GMCH belongs to the category of devices that does not corrupt programs or data in system memory or hard drives, the GMCH ignores any parity error that it detects and continues with normal operation.
5	Video Palette Snooping (VPS)—RO. Hardwired to 0. Disables snooping.
4	Memory Write and Invalidate Enable (MWIE)—RO. Hardwired to 0. GMCH does not support memory write and invalidate commands.
3	Special Cycle Enable (SCE)—RO. Hardwired to 0. GMCH ignores Special cycles.
2	Bus Master Enable (BME)—RO. Hardwired to 1 to enable GMCH to function as a PCI compliant master.
1	Memory Access Enable (MAE)—R/W. This bit controls the GMCH's response to memory space accesses. 0 = Disable (default). 1 = Enable.
0	I/O Access Enable (IOAE)—R/W. This bit controls the GMCH's response to I/O space accesses. 0 = Disable (default). 1 = Enable.

3.6.4. PCISTS2—PCI Status Register (Device 2)

Address Offset: 06h–07h
 Default Value: 02B0h
 Access: Read-Only
 Size: 16 bits

PCISTS2 reports the occurrence of a PCI compliant master abort and PCI compliant target abort. PCISTS2 also indicates the DEVSEL# timing that has been set by the GMCH hardware.

15	14	13	12	11	10	9	8
Detected Par Error (HW=0)	Sig Sys Error (HW=0)	Recog Mast Abort Sta (HW=0)	Rec Target Abort Sta (HW=0)	Sig Target Abort Sta (HW=0)	DEVSEL# Timing (HW=01)		Data Par Detected (HW=0)
7	6	5	4	3	Reserved		
FB2B (HW=1)	User Def Format (HW=0)	66 MHz PCI Cap (HW=1)	Cap List (HW=1)				

Bits	Description
15	Detected Parity Error (DPE) —RO. Hardwired to 0. The chipset does not detect parity.
14	Signaled System Error (SSE) —RO. Hardwired to 0. The chipset's graphics device never asserts SERR#.
13	Received Master Abort Status (RMAS) —RO. Hardwired to 0. The chipset's graphics device never gets a Master Abort.
12	Received Target Abort Status (RTAS) —RO. Hardwired to 0. The chipset's graphics device never gets a Target Abort.
11	Signaled Target Abort Status (STAS) . Hardwired to 0. The chipset does not use target abort semantics.
10:9	DEVSEL# Timing (DEVT) —RO. This 2-bit field indicates the timing of the DEVSEL# signal when GMCH responds as a target. 01 = Medium decode device (hardwired).
8	Data Parity Detected (DPD) —RO. Hardwired to 0. Since Parity Error Response is hardwired to disabled (and GMCH does not do any parity detection), this bit is not used.
7	Fast Back-to-Back (FB2B) . Hardwired to 1. The chipset accepts fast back-to-back when the transactions are not to the same agent.
6	User Defined Format (UDF) . Hardwired to 0.
5	66 MHz PCI Capable (66C) . Hardwired to 1. This indicates that the chipset is 66 MHz PCI capable.
4	CAP LIST —RO. This bit is set to 1 to indicate that the register at 34h provides an offset into the function's PCI Configuration Space containing a pointer to the location of the first item in the list.
3:0	Reserved.

3.6.5. RID2—Revision Identification Register (Device 2)

Address Offset:	08h
Default Value:	02h (see Spec. Update document for latest information.)
Access:	Read-Only
Size:	8 bits

This register contains the revision number of the chipset. These bits are read-only and writes to this register have no effect.

Bits	Description
7:0	Revision Identification Number. This is an 8-bit value that indicates the revision identification number for the GMCH. The four MSBs are for process differentiation and the four LSBs indicate stepping.

3.6.6. PI—Programming Interface Register (Device 2)

Address Offset:	09h
Default Value:	00h
Access:	Read-Only
Size:	8 bits

This register contains the device programming interface for the GMCH.

Bits	Description
7:0	Programming Interface (PI). Hardwired to 00h. 00h = Display controller.

3.6.7. SUBC2—Sub-Class Code Register (Device 2)

Address Offset:	0Ah
Default Value:	00h
Access:	Read-Only
Size:	8 bits

This register contains the Sub-Class Code for the GMCH Device 2.

Bit	Description
7:0	Sub-Class Code (SUBC). This is an 8-bit value that indicates the category of display controller of the GMCH. 00h = VGA compatible device.

3.6.8. BCC2—Base Class Code Register (Device 2)

Address Offset: 0Bh
 Default Value: 03h
 Access: Read-Only
 Size: 8 bits

This register contains the Base Class Code of the GMCH Function #1.

Bit	Description
7:0	Base Class Code (BASEC). This is an 8-bit value that indicates the Base Class Code for GMCH. 03h = Display controller.

3.6.9. CLS—Cache Line Size Register (Device 2)

Address Offset: 0Ch
 Default Value: 00h
 Access: Read-Only
 Size: 8 bits

The GMCH does not support this register as a PCI slave.

Bits	Description
7:0	Cache Line Size (CLS). This field is hardwired to 0s. The GMCH, as a PCI compliant master, does not use the Memory Write and Invalidate command and, in general, does not perform operations based on cache line size.

3.6.10. MLT2—Master Latency Timer Register (Device 2)

Address Offset: 0Dh
 Default Value: 00h
 Access: Read-Only
 Size: 8 bits

The GMCH does not support the programmability of the master latency timer because it does not perform bursts.

Bits	Description
7:0	Master Latency Timer Count Value. Hardwired to 0s.

3.6.11. HDR2—Header Type Register (Device 2)

Address Offset: 0Eh
 Default Value: 00h
 Access: Read-Only
 Size: 8 bits

This register contains the Header Type of the GMCH .

Bits	Description
7:0	Header Type (HTYPE). This is an 8-bit value that indicates the Header Type for the chipset. 00h = Indicating a basic (i.e., single function) configuration space format.

3.6.12. BIST—BIST Register (Device 2)

Address Offset: 0Fh
 Default Value: 00h
 Access: Read-Only
 Size: 8 bits

This register is used for control and status of Built In Self Test (BIST).

7	6	0
BIST Supported (HW=0)	Reserved	

Bits	Description
7	BIST Supported. BIST is not supported. This bit is hardwired to 0.
6:0	Reserved.

3.6.13. GMADR—Graphics Memory Range Address Register (Device 2)

Address Offset: 10–13h
 Default Value: 00000008h
 Access: Read/Write, Read-Only
 Size: 32 bits

This register requests allocation for the GMCH graphics memory. The allocation is for either 32 MB or 64 MB of memory space (selected by bit 0 of the Device 0 MISCC Register) and the base address is defined by bits [31:25,24].

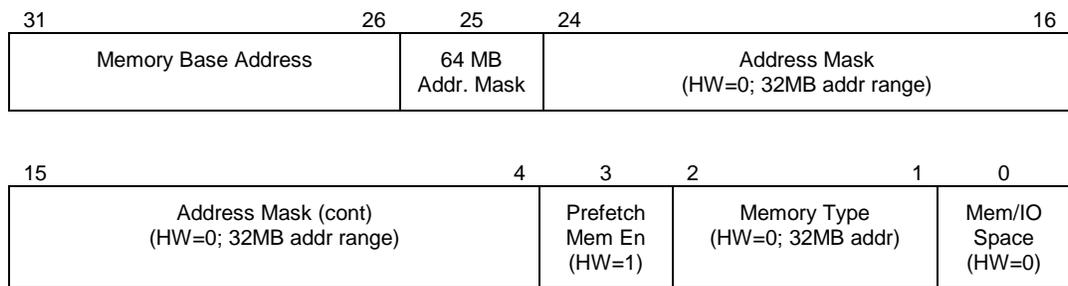

Bit	Description
31:26	Memory Base Address—R/W. Set by the operating system, these bits correspond to address signals [31:26].
25	64 MB Address Mask—RO , R/W. 64 MB = If Device 0 MISCC Reg bit 0 = 0, then this bit is read-only with a value of 0, indicating a memory range of 64 MB. 32 MB = If Device 0 MISCC Reg bit 0 = 1, this bit is R/W, indicating a memory range of 32 MB.
24:4	Address Mask—RO. Hardwired to 0s to indicate 32 MB address range.
3	Prefetchable Memory—RO. Hardwired to 1 to enable prefetching.
2:1	Memory Type—RO. Hardwired to 0 to indicate 32-bit address.
0	Memory/IO Space—RO. Hardwired to 0 to indicate memory space.

3.6.14. MMADR—Memory Mapped Range Address Register (Device 2)

Address Offset: 14–17h
 Default Value: 00000000h
 Access: Read/Write, Read-Only
 Size: 32 bits

This register requests allocation for the GMCH registers and instruction ports. The allocation is for 512 KB and the base address is defined by bits [31:19].

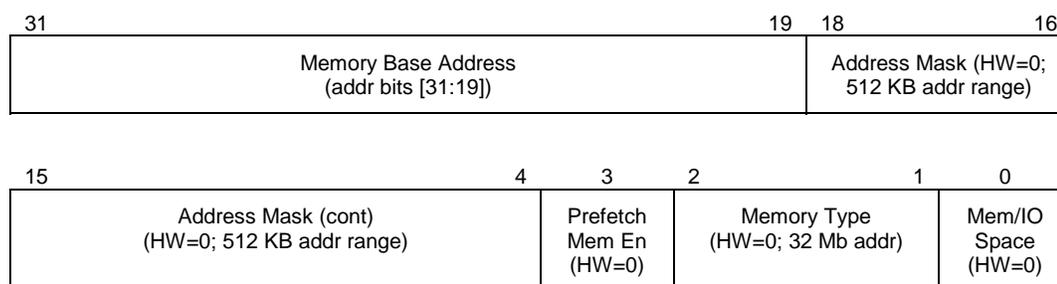

Bit	Description
31:19	Memory Base Address—R/W. Set by the operating system, these bits correspond to address signals [31:19].
18:4	Address Mask—RO. Hardwired to 0s to indicate 512 KB address range.
3	Prefetchable Memory—RO. Hardwired to 0 to prevent prefetching.
2:1	Memory Type—RO. Hardwired to 0s to indicate 32-bit address.
0	Memory / IO Space—RO. Hardwired to 0 to indicate memory space.

3.6.15. SVID—Subsystem Vendor Identification Register (Device 2)

Address Offset: 2C–2Dh
 Default Value: 0000h
 Access: Read/Write-Once
 Size: 16 bits

Bit	Description
15:0	Subsystem Vendor ID—R/WO. This value is used to identify the vendor of the subsystem. The default value is 0000h. This field should be programmed by BIOS during boot-up. Once written, this register becomes read-only. This Register can only be cleared by a Reset.

3.6.16. SID—Subsystem Identification Register (Device 2)

Address Offset: 2E–2Fh
 Default Value: 0000h
 Access: Read/Write-Once
 Size: 16 bits

Bit	Description
15:0	Subsystem ID—R/WO. This value is used to identify a particular subsystem. The default value is 0000h. This field should be programmed by BIOS during boot-up. Once written, this register becomes Read only. This Register can only be cleared by a Reset.

3.6.17. ROMADR—Video BIOS ROM Base Address Register (Device 2)

Address Offset: 30–33h
 Default Value: 00000000h
 Access: Read Only
 Size: 32 bits

The GMCH does not use a separate BIOS ROM; therefore, this is hardwired to 0s.

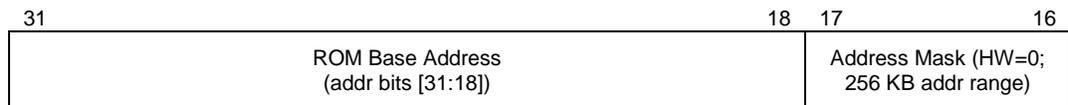

Bit	Description
31:18	ROM Base Address—RO. Hardwired to 0s.
17:11	Address Mask—RO. Hardwired to 0s to indicate 256 KB address range.
10:1	Reserved. Hardwired to 0s.
0	ROM BIOS Enable—RO. 0 = ROM not accessible.

3.6.18. CAPPOINT—Capabilities Pointer Register (Device 2)

Address Offset: 34h
 Default Value: DCh
 Access: Read Only
 Size: 8 bits

Bit	Description
7:0	Pointer to the start of AGP standard register block. Since there is no AGP bus on the GMCH, the value of this field is DCh. DCh = Points to the Power Management Capabilities ID Register

3.6.19. INTRLINE—Interrupt Line Register (Device 2)

Address Offset: 3Ch
 Default Value: 00h
 Access: Read/Write
 Size: 8 bits

Bit	Descriptions
7:0	Interrupt Connection. Used to communicate interrupt line routing information. POST software writes the routing information into this register as it initializes and configures the system. The value in this register indicates which input of the system interrupt controller that the device's interrupt pin is connected.

3.6.20. INTRPIN—Interrupt Pin Register (Device 2)

Address Offset: 3Dh
 Default Value: 01h
 Access: Read Only
 Size: 8 bits

Bit	Descriptions
7:0	Interrupt Pin. As a single function device, the GMCH specifies INTA# as its interrupt pin. 01h = INTA#.

3.6.21. MINGNT—Minimum Grant Register (Device 2)

Address Offset: 3Eh
 Default Value: 00h
 Access: Read Only
 Size: 8 bits

Bit	Descriptions
7:0	Minimum Grant Value. The GMCH does not burst as a PCI compliant master. (Default=00h).

3.6.22. MAXLAT—Maximum Latency Register (Device 2)

Address Offset: 3Fh
 Default Value: 00h
 Access: Read Only
 Size: 8 bits

Bit	Descriptions
7:0	Maximum Latency Value. The GMCH has no specific requirements for how often it needs to access the PCI bus. (Default=00h).

3.6.23. PM_CAPID—Power Management Capabilities ID Register (Device 2)

Address Offset: DCh–DDh
 Default Value: 0001h
 Access: Read Only
 Size: 16 bits

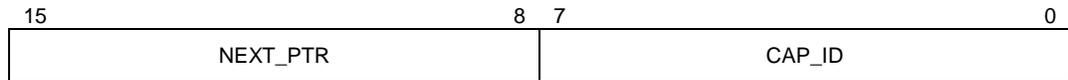

Bits	Description
15:8	Next Pointer (NEXT_PTR). This contains a pointer to next item in the capabilities list. This the final capability in the list and must be set to 00h.
7:0	Capability Identificaiton (CAP_ID). SIG defines this ID is 01h for power management.

3.6.24. PM_CAP—Power Management Capabilities Register (Device 2)

Address Offset: DEh–DFh
 Default Value: 0022h
 Access: Read Only
 Size: 16 bits

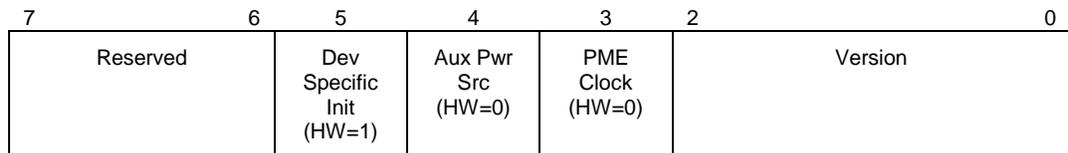
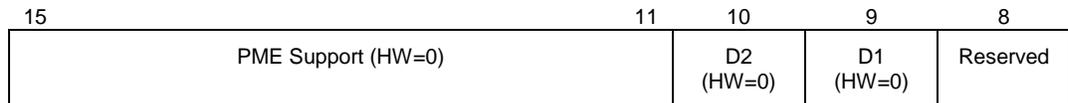

Bits	Description
15:11	PME Support. This field indicates the power states in which the GMCH may assert PME#. Hardwired to 0 to indicate that the GMCH does not assert the PME# signal.
10	D2. Hardwired to 0 to indicate D2 power management state is not supported.
9	D1. Hardwired to 0 to indicate that D1 power management state is NOT supported.
8:6	Reserved. Read as 0s.
5	Device Specific Initialization (DSI). Hardwired to 1 to indicate that special initialization of the GMCH is required before generic class device driver is to use it.
4	Auxiliary Power Source. Hardwired to 0.
3	PME Clock. Hardwired to 0 to indicate the GMCH does not support PME# generation.
2:0	Version. Hardwired to 010b to indicate there are 4 bytes of power management registers implemented and that this device complies with revision 1.1 of the <i>PCI Power Management Interface Specification</i> .

3.6.25. PM_CS—Power Management Control/Status Register (Device 2)

Address Offset: E0h–E1h
 Default Value: 0000h
 Access: Read/Write
 Size: 16 bits

15	14	13	12	9	8
PME Sta (HW=0)	Data Scale (Reserved)	Data_Select (Reserved)			PME En

7	2	1	0
Reserved			PowerState

Bits	Description
15	PME_Status —RO. This bit is 0 to indicate that the GMCH does not support PME# generation from D3 (cold).
14:13	Data Scale (Reserved) —RO. The GMCH does not support data register. This bit always returns 0 when read; write operations have no effect.
12:9	Data_Select (Reserved) —RO. The GMCH does not support data register. This bit always returns 0 when read; write operations have no effect.
8	PME_En—R/W. This bit is 0 to indicate that PME# assertion from D3 (cold) is disabled.
7:2	Reserved. Always returns 0s when read; write operations have no effect.
1:0	PowerState—R/W. This field indicates the current power state of the GMCH and can be used to set the GMCH into a new power state. If software attempts to write an unsupported state to this field, write operation must complete normally on the bus; data is discarded and no state change occurs. 00 = D0 01 = D1 (Not supported in the GMCH) 10 = D2 (Not supported in the GMCH) 11 = D3

3.7. Display Cache Interface

The Display Cache (DC) interface control registers are located in Memory Space. This section describes the DC interface registers. These registers are accessed using [MMADR+Offset]. These registers are memory-mapped only.

3.7.1. DRT—DRAM Row Type

Memory Offset Address: 3000h
 Default value: 00h
 Access: Read / write
 Size: 8 bit

This 8-bit register identifies whether or not the display cache is populated. Memory mapped only.

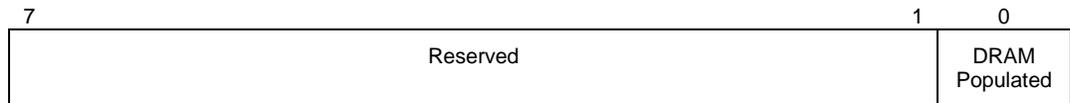

Bit	Description
7:1	Reserved
0	DRAM Populated (DP). The bit in this register indicates whether or not the display cache is populated. 0 = No Display Cache 1 = 4 MB Display Cache

3.7.2. DRAMCL—DRAM Control Low

Memory Offset Address: 3001h
 Default value: 17h
 Access: Read / write
 Size: 8 bit

7	5	4	3	2	1	0
Reserved		Paging Mode Control	RAS-to- CAS Override	CAS# Latency	RAS# Riming	RAS# Precharge Timing

Bit	Description									
7:5	Reserved									
4	Paging Mode Control (PMC). 0 = Page Open Mode. In this mode the GMCH memory controller tends to leave pages open. 1 = Page Close Mode. In this mode the GMCH memory controller tends to leave pages closed.									
3	RAS-to-CAS Override (RCO). In units of display cache clock periods indicates the RAS#-to-CAS# delay (t_{RCD}). (i.e., row activate command to read/write command) 0 = Determined by CL bit (default) 1 = 2									
2	CAS# Latency (CL). In units of local memory clock periods. <table border="1" style="width: 100%; border-collapse: collapse;"> <thead> <tr> <th style="text-align: left;">Bit</th> <th style="text-align: left;">CL</th> <th style="text-align: left;">RAS#-to-CAS# delay (t_{RCD})</th> </tr> </thead> <tbody> <tr> <td>0</td> <td>2</td> <td>2</td> </tr> <tr> <td>1</td> <td>3</td> <td>3 (default)</td> </tr> </tbody> </table>	Bit	CL	RAS#-to-CAS# delay (t_{RCD})	0	2	2	1	3	3 (default)
Bit	CL	RAS#-to-CAS# delay (t_{RCD})								
0	2	2								
1	3	3 (default)								
1	RAS# Timing (RT). This bit controls RAS# active to precharge, and refresh to RAS# active delay (in local memory clocks). <table border="1" style="width: 100%; border-collapse: collapse;"> <thead> <tr> <th style="text-align: left;">Bit</th> <th style="text-align: left;">RAS# act. To precharge (t_{RAS})</th> <th style="text-align: left;">Refresh to RAS# act. (t_{RC})</th> </tr> </thead> <tbody> <tr> <td>0</td> <td>5</td> <td>8</td> </tr> <tr> <td>1</td> <td>7</td> <td>10 (default)</td> </tr> </tbody> </table>	Bit	RAS# act. To precharge (t_{RAS})	Refresh to RAS# act. (t_{RC})	0	5	8	1	7	10 (default)
Bit	RAS# act. To precharge (t_{RAS})	Refresh to RAS# act. (t_{RC})								
0	5	8								
1	7	10 (default)								
0	RAS# Precharge Timing (RPT). This bit controls RAS# precharge (in local memory clocks). 0 = 2 1 = 3 (default)									

3.8. Display Cache Detect and Diagnostic Registers

The following registers are used for display cache detection and diagnostics. These registers can be accessed via either I/O space or memory space. The memory space addresses listed are offsets from the base memory address programmed into the MMADR register (Device 2, PCI configuration offset 14h). For each register, the memory-mapped address offset is the same address value as the I/O address.

3.8.1. GRX—GRX Graphics Controller Index Register

I/O (and Memory Offset) Address: 3CEh
 Default: 0Uh (U=Undefined)
 Access: Read/Write
 Size: 8 bits



Bit	Description
7:4	Reserved. Read as 0s.
3:0	Sequencer Register Index. This field selects any one of the graphics controller registers (GR[00:08]) to be accessed via the data port at I/O location 3CFh.

3.8.2. MSR—Miscellaneous Output

I/O (and Memory Offset) Address: 3C2h — Write; 3CCh — Read
 Default: 00h
 Access: See Address above
 Size: 8 bits



Bit	Descriptions
7:2	Reserved
1	<p>A0000–BFFFFh Access Enable. VGA Compatibility bit enables access to the display cache at A0000h–BFFFFh. When disabled, accesses to system memory are blocked in this region (by not asserting DEVSEL#). This bit does not block processor access to the video linear frame buffer at other addresses.</p> <p>0 = Prevent processor access to the display cache (default). 1 = Allow processor access to display cache.</p>
0	Reserved

3.8.3. GR06—Miscellaneous Register

I/O (and Memory Offset) Address: 3CFh (Index=06h)
 Default: 0Uh (U=Undefined)
 Access: Read/Write
 Size: 8 bits

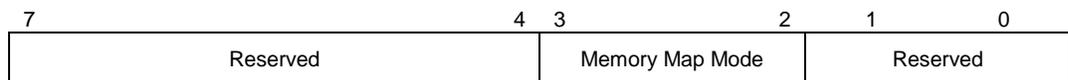

Bit	Description
7:4	Reserved
3:2	<p>Memory Map Mode. These 2 bits control the mapping of the VGA frame buffer into the processor address space as follows:</p> <p>00 = A0000h – BFFFFh 01 = A0000h – AFFFFh 10 = B0000h – B7FFFh 11 = B8000h – BFFFFh</p> <p>Note: This function is both in standard VGA modes and in extended modes that do not provide linear frame buffer accesses.</p>
1:0	Reserved

3.8.4. GR10—Address Mapping

I/O (and Memory Offset) Address: 3CFh (Index=10h)
 Default: 00h
 Access: R/W
 Size: 8 bits

7	5	4	3	2	1	0
Reserved		Paging to display cache	VGA Buffer /Memory Map	Packed Mode Enbl	Linear Mapping	Page Mapping

Bit	Description
7:5	Reserved
4	Page to Display Cache Enable. 0 = Page to VGA Buffer. 1 = Page to Display Cache.
3	VGA Buffer/Memory Map Select. 0 = VGA Buffer (default) 1 = Memory Map.
2	Packed Mode Enable. 0 = Disable (default) 1 = Enable
1	Linear Mapping (PCI). 0 = Disable (default) 1 = Enable
0	Page Mapping Enable. This mode allows the mapping of the vga space allocated in main memory (non local video memory) mode or all of local memory space through the A0000:AFFFF window which is a 64 KB page. 0 = Disable (default) 1 = Enable

3.8.5. GR11—Page Selector

I/O (and Memory Offset) Address: 3CFh (Index=11h)
 Default : 00h
 Attributes: R/W

Bit	Description
7:0	Page Select. Selects a 64 KB window within the display cache when Page Mapping is enabled to the display cache.

4. Functional Description

This chapter describes the Graphics and Memory Controller Hub (GMCH) interfaces, and boot sequencing. The “System Address Map” provides a system-level address memory map and describes the memory space controls provided by the GMCH.

4.1. System Address Map

An Intel® Pentium III processor, Intel® Pentium II processor, or Intel® Celeron™ processor system based on the GMCH, supports 4 GB of addressable memory space and 64 KB+3 of addressable I/O space. (The P6 bus I/O addressability is 64KB + 3). There is a programmable memory address space under the 1 MB region which can be controlled with programmable attributes of write-only, or read-only. Attribute programming is described in the Configuration Register Description section. This section focuses on how the memory space is partitioned and what these separate memory regions are used for. The I/O address space is explained at the end of this section.

The Intel® Pentium III processor, Intel® Pentium II processor, and Intel® Celeron™ processor supports addressing of memory ranges larger than 4 GB. The GMCH Host Bridge claims any access over 4 GB by terminating transaction (without forwarding it to the hub interface). Writes are terminated by dropping the data and for reads the GMCH returns all zeros on the host bus.

In the following sections, it is assumed that all of the compatibility memory ranges reside on the hub interface. The exceptions to this rule are the VGA ranges which may be mapped to the internal Graphics Device.

Note: The GMCH memory map includes a number of programmable ranges. All of these ranges MUST be unique and NON-OVERLAPPING. There are NO Hardware Interlocks to prevent problems in the case of overlapping ranges. Accesses to overlapped ranges may produce indeterminate results.

4.1.1. Memory Address Ranges

Figure 4 shows a high-level representation of the system memory address map. Figure 5 provides additional details on mapping specific memory regions as defined and supported by the GMCH.

Figure 4. System Memory Address Map

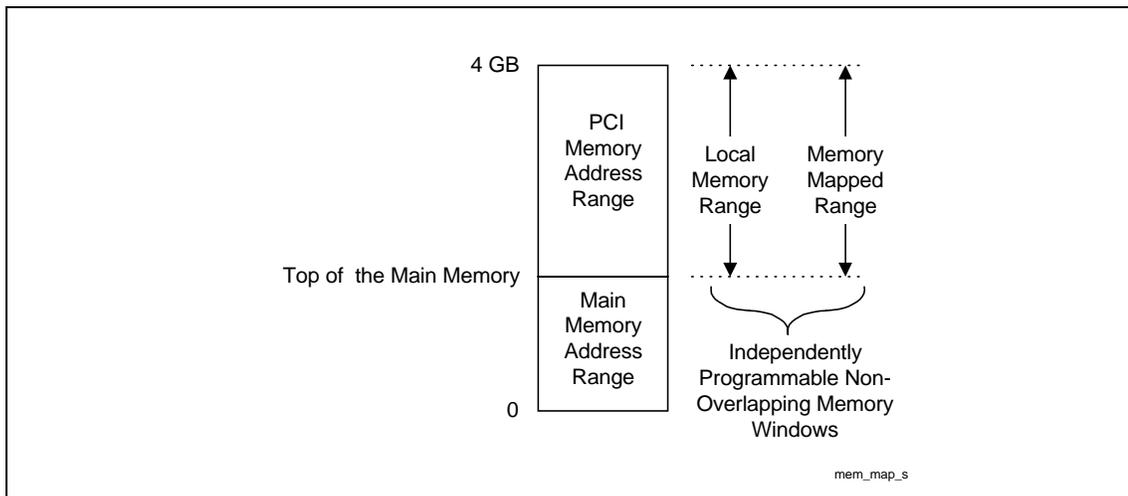
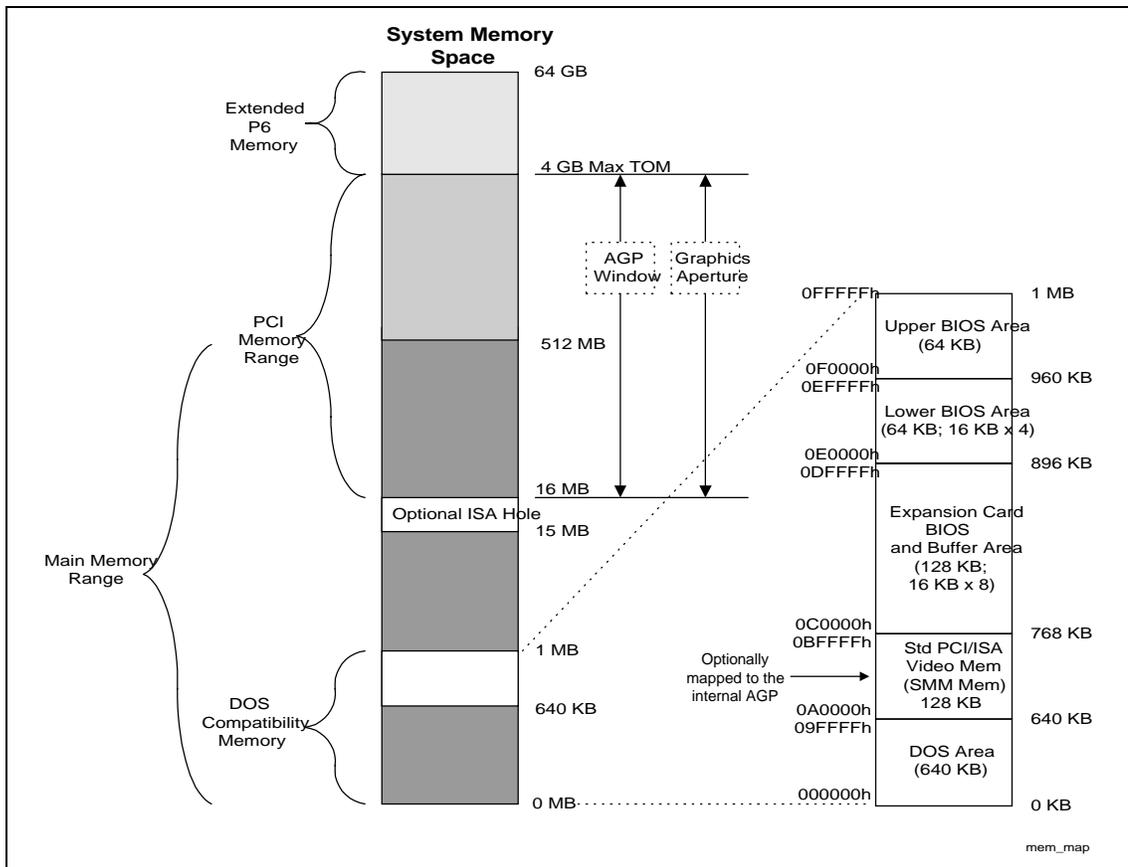

Figure 5. Detailed Memory System Address Map



4.1.2. Compatibility Area

This area is divided into the following address regions:

- 0–640 KB DOS Area
- 640–768 KB Video Buffer Area
- 768–896 KB in 16KB sections (total of 8 sections) – Expansion Area
- 896–960 KB in 16KB sections (total of 4 sections) – Extended System BIOS Area
- 960 KB–1 MB Memory (BIOS Area) – System BIOS Area

The GMCH supports all sixteen memory segments of interest in the compatibility area. Thirteen of the memory ranges can be enabled or disabled independently for both read and write cycles.

Table 9. Memory Segments and Their Attributes

Memory Segments	Attributes	Comments
000000h–09FFFFh	Fixed; always mapped to main DRAM	0 to 640K: DOS Region
0A0000h–0BFFFFh	mapped to the hub interface or (AGP or internal graphics) – configurable as SMM space	Video Buffer (physical DRAM configurable as SMM space)
0C0000h–0C3FFFh	WE RE	Add-on BIOS
0C4000h–0C7FFFh	WE RE	Add-on BIOS
0C8000h–0CBFFFh	WE RE	Add-on BIOS
0CC000h–0CFFFFh	WE RE	Add-on BIOS
0D0000h–0D3FFFh	WE RE	Add-on BIOS
0D4000h–0D7FFFh	WE RE	Add-on BIOS
0D8000h–0DBFFFh	WE RE	Add-on BIOS
0DC000h–0DFFFFh	WE RE	Add-on BIOS
0E0000h–0E3FFFh	WE RE	BIOS Extension
0E4000h–0E7FFFh	WE RE	BIOS Extension
0E8000h–0EBFFFh	WE RE	BIOS Extension
0EC000h–0EFFFFh	WE RE	BIOS Extension
0F0000h–0FFFFFFh	WE RE	BIOS Area

DOS Area (00000h–9FFFh)

The DOS area is 640 KB and is always mapped to the main memory controlled by the GMCH.

Video Buffer Area (A0000h–BFFFFh)

The 128 KB graphics adapter memory region is normally mapped to a legacy video device on the hub interface/PCI (typically VGA controller). This area is not controlled by attribute bits and processor – initiated cycles in this region are forwarded to either the hub interface or the AGP/internal graphics device for termination. This region is also the default region for SMM space.

Accesses to this range are directed to either the hub interface or the AGP/internal graphics device based on the configuration. The configuration is specified by:

1. AGP on/off configuration bit
2. AGP off: GMS bits of the SMRAM register in the GMCH Device #0 configuration space. There is additional steering information coming from the Device #2 configuration registers and from some of the VGA registers in the Graphics device.
3. AGP on: PCICMD1 (PCI-PCI Command) and BCTRL (PCI-PCI Bridge Control) registers in Device #1 configuration registers

The control is applied for accesses initiated from any of the system interfaces; that is, processor bus, the hub interface, or AGP(if enabled). Note that for hub interface to AGP/PCI accesses, only memory write operations are supported. Any AGP/PCI initiated VGA accesses targeting the GMCH will master abort. For more details, see the descriptions in the configuration registers specified above.

The SMRAM Control register controls how SMM accesses to this space are treated.

Monochrome Adapter (MDA) Range (B0000h–B7FFFh)

Legacy support requires the ability to have a second graphics controller (monochrome) in the system.

In an AGP system, accesses in the standard VGA range are forwarded to the AGP bus (depending on configuration bits). Since the monochrome adapter may be on the hub interface/PCI (or ISA) bus, the GMCH must decode cycles in the MDA range and forward them to the hub interface. This capability is controlled by a configuration bit (MDA bit – Device 0, BEh). In addition to the memory range B0000h to B7FFFh, the GMCH decodes IO cycles at 3B4h, 3B5h, 3B8h, 3B9h, 3Bah and 3BFh and forwards them to the hub interface bus

In an internal graphics system, the GMS bits of the SMRAM register in Device #0, bits in the Device 2 PCICMD2 register and bits from some of the VGA registers control this functionality.

Expansion Area (C0000h–DFFFFh)

This 128 KB ISA Expansion region is divided into eight 16 KB segments. Each segment can be assigned one of four read/write states: read only, write-only, read/write, or disabled. Typically, these blocks are mapped through GMCH and are subtractively decoded to ISA space. Memory that is disabled is not remapped.

Extended System BIOS Area (E0000h–EFFFFh)

This 64 KB area is divided into four 16 KB segments. Each segment can be assigned independent read and write attributes so it can be mapped either to main DRAM or to the hub interface. Typically, this area is used for RAM or ROM. Memory segments that are disabled are not remapped elsewhere.

System BIOS Area (F0000h–FFFFFh)

This area is a single 64 KB segment. This segment can be assigned read and write attributes. It is by default (after reset) read/write disabled and cycles are forwarded to the hub interface. By manipulating the read/write attributes, the GMCH can “shadow” BIOS into the main DRAM. When disabled, this segment is not remapped.

4.1.3. Extended Memory Area

This memory area covers 100000h (1 MB) to FFFFFFFFh (4 GB-1) address range and it is divided into the following regions:

- Main DRAM Memory from 1 MB to the Top of Memory; maximum of 512 MB using 128M technology
- PCI Memory space from the Top of Memory to 4 GB with two specific ranges:
- APIC Configuration Space from FEC0_0000h (4 GB-20 MB) to FECF_FFFFh and FEE0_0000h to FEEF_FFFFh
- High BIOS area from 4 GB to 4 GB–2 MB

Main DRAM Address Range (0010_0000h to Top of Main Memory)

The address range from 1 MB to the top of main memory (TOM) is mapped to main DRAM address range. The Top of memory is limited to 512 MB. All accesses to addresses within this range will be forwarded to the DRAM unless a hole in this range is created.

15 MB–16 MB Hole

A hole can be created at 15 MB–16 MB as controlled by the fixed hole enable (FDHC register) in Device 0 space. Accesses within this hole are forwarded to the hub interface. The range of physical DRAM memory disabled by opening the hole is not remapped to the Top of the memory – that physical DRAM space is not accessible. This 15 MB–16 MB hole is an optionally enabled ISA hole. Video accelerators originally used this hole. It is also used by validation and customer SV teams for some of their test cards. This is why it is being supported. There is no inherent BIOS request for the 15–16 MB hole.

Extended SMRAM Address Range (Top of Main Memory–TSEG)

The HSEG and TSEG SMM transaction address spaces reside in this extended memory area.

HSEG

SMM-mode processor accesses to enabled HSEG are remapped to 000A0000h–000BFFFFh. Non-SMM-mode processor accesses to enabled HSEG are considered invalid and are terminated immediately on the FSB. The exception to this is non-SMM-mode write-back cycles. They are remapped to SMM space to maintain cache coherency. AGP and hub interface originated cycles to enabled SMM space are not allowed. Physical DRAM behind the HSEG transaction address is not remapped and is not accessible.

TSEG

TSEG can be up to 1 MB and is at the top of memory. SMM-mode processor accesses to enabled TSEG access the physical DRAM at the same address. Non-SMM-mode processor accesses to enabled TSEG are considered invalid and are terminated immediately on the FSB. The exception is non-SMM-mode write-back cycles. They are directed to the physical SMM space to maintain cache coherency. AGP and hub interface originated cycle to enabled SMM space are not allowed.

The size of the SMRAM space is determined by the USMM value in the SMRAM register. When the extended SMRAM space is enabled, non-SMM processor accesses and all other accesses in this range are forwarded to the hub interface. When SMM is enabled, the amount of memory available to the system is equal to the amount of physical DRAM minus the value in the TSEG register.

Note that there is potential for cache corruption if illegal accesses are requested to TSEG. Originally, TSEG was intended for additional data storage for non-cached solutions. As such, it added protection as direct reads and writes to TSEG are not allowed to occur outside of SMM. However, when the region is enabled as cacheable, this protection can cause problems if improperly used. The reason is that, if any piece of software (including ITP) is to read TSEG outside of SMM, the read can cause corruption of the cached version of the code in the processor and result in a SMM “hang”.

Example of Problem Manifestation:

1. SMM handler initialized and SMM code/data is written to TSEG
2. Processor cache emptied of TSEG data sometime later as cache lines are evicted and replaced
3. Rogue application requests illegal memory read to TSEG (illegal because processor is not in SMM)
4. Processor runs memory read cycles to GMCH to perform read from TSEG
5. GMCH realizes processor is NOT in SMM and blocks the reads from targeting actual memory. Instead it runs the cycle down the hub interface, which ICH2 then converts to a PCI cycle. This typically gets master aborted and returns a floating bus (FFFFFFFFh).
6. Processor read cycles complete and FFFFFFFFh is pulled into processor cache lines.
7. Processor thinks it has valid TSEG code/data in its cache, when it really has incorrect data (FFFFFFFFh)
8. Processor runs other system level code, evicting cache lines as needed, but some lines of FFFFFFFFh remain
9. Eventually, an SMI is generated and this puts the processor into SMM and calls for execution of the SMM handler stored in TSEG.
10. Processor begins fetching TSEG and hits a line in its cache read by the rogue application (FFFFFFFFh).
11. This code is corrupted and a “hang” is eminent

The result is that the TSEG protection built into the chipset could potentially cause a system to “hang” for cached operations, if not properly used. In fact, an application that only reads from the TSEG region can cause SMRAM corruption by causing the SMM handler to execute bogus code fetched from the PCI bus.

An alternative is to not use TSEG chipset features at all when running cached. Simply reserve a piece of system memory at the top of memory region, indicate a lower actual top of memory to the operating system (through E820h/E801h function calls), and use this region as SMRAM. As there is no restriction that this memory cannot be accessed when not in SMM mode, then the GMCH will not block accesses to it. When it is cached, a read to the region (whether performed inside or outside of SMRAM) will return the correct data and this coherency issue is avoided.

PCI Memory Address Range (Top of Main Memory to 4 GB)

The address range from the top of main DRAM to 4 GB (top of physical memory space supported by the GMCH) is normally mapped via the hub interface to PCI.

As an internal graphics configuration, there are two exceptions to this rule. Both exception cases are forwarded to the internal graphics device.

- The first exception is addresses decoded to the local memory range.
- The second exception is addresses decoded to the memory mapped range of the internal graphics device.

As an AGP configuration, there are two exceptions to this rule.

- Addresses decoded to the AGP memory window defined by the MBASE, MLIMIT, PMBASE, and PMLIMIT registers are mapped to AGP.
- Addresses decoded to the graphics aperture range defined by the APBASE and APSIZE registers are mapped to the main DRAM.

There are two sub-ranges within the PCI memory address range defined as APIC Configuration Space and High BIOS Address Range. *As an internal graphics device, the Local Memory Range and the Memory Mapped Range of the internal Graphics Device **MUST NOT** overlap with these two ranges. Similarly, as an AGP device, the AGP memory window and Graphics Aperture Window **MUST NOT** overlap with these two ranges.* These ranges are described in detail in the following paragraphs.

APIC Configuration Space (FEC0_0000h –FECF_FFFFh, FEE0_0000h– FEEF_FFFFh)

This range is reserved for APIC configuration space, which includes the default I/O APIC configuration space. The default Local APIC configuration space is FEE0_0000h to FEEF_0FFFh.

Processor accesses to the local APIC configuration space do not result in external bus activity since the local APIC configuration space is internal to the processor. However, a MTRR must be programmed to make the local APIC range uncacheable (UC). The local APIC base address in each processor should be relocated to the FEC0_0000h (4 GB – 20 MB) to FECF_FFFFh range so that one MTRR can be programmed to 64 KB for the local and I/O APICs. *The I/O APIC(s) usually reside in the I/O Bridge portion (I/O Controller Hub) of the chipset or as a stand-alone component(s).*

I/O APIC units will be located beginning at the default address FEC0_0000h. The first I/O APIC will be located at FEC0_0000h. Each I/O APIC unit is located at FEC0_x000h where *x* is I/O APIC unit number 0 through F(hex). This address range will be normally mapped via the hub interface to PCI.

Note: There is no provision to support an I/O APIC device on AGP

The address range between the APIC configuration space and the High BIOS (FED0_0000h to FFDF_FFFFh) is always mapped via the hub interface to PCI.

High BIOS Area (FFE0_0000h –FFFF_FFFFh)

The top 2 MB of the extended memory region is reserved for system BIOS (High BIOS), extended BIOS for PCI devices, and the A20 alias of the system BIOS. The processor begins execution from the High BIOS after reset. This region is mapped via the hub interface to PCI so that the upper subset of this region aliases to 16 MB–256 MB range. The actual address space required for the BIOS is less than 2 MB but the minimum processor MTRR range for this region is 2 MB so that full 2 MB must be considered. The I/O Controller Hub supports a maximum of 1 MB in the High BIOS range.

4.1.3.1. System Management Mode (SMM) Memory Range

The GMCH supports the use of main memory as System Management RAM (SMRAM) enabling the use of System Management Mode (SMM). The GMCH supports three SMM options: Compatible SMRAM (AB segment enabled), High Segment (HSEG), and Top of Memory Segment (TSEG). System Management RAM (SMRAM) space provides a memory area that is available for the SMI handler's code and data storage. This memory resource is normally hidden from the operating system so that the processor has immediate access to this memory space upon entry to SMM. The GMCH provides three SMRAM options:

- Below 1 MB option that supports compatible SMI handlers.
- Above 1 MB option that allows new SMI handlers to execute with write-back cacheable SMRAM.
- Optional larger write-back cacheable T_SEG area of either 512 KB or 1MB in size above 1 MB that is reserved from the highest area in system DRAM memory. The above 1 MB solutions require changes to compatible SMRAM handler's code to properly execute above 1 MB.

Refer to the *Power Management* section for more details on SMRAM support.

Note: The hub interface and AGP masters are not allowed to access the SMM space. This must be insured even for the GTLB translation.

4.2. Memory Shadowing

Any block of memory that can be designated as read only or write-only can be “shadowed” into GMCH DRAM memory. Typically, this is done to allow ROM code to execute more rapidly out of main DRAM. ROM is used as a read-only during the copy process while DRAM at the same time is designated write-only. After copying, the DRAM is designated read-only so that ROM is shadowed. Processor bus transactions are routed accordingly.

4.3. I/O Address Space

- The GMCH never responds to I/O cycles initiated on AGP.
- The GMCH does not support the existence of any other I/O devices other than itself on the processor bus. The GMCH generates either hub interface or AGP/PCI (if enabled) bus cycles for all processor I/O accesses. If internal graphics is enabled, the GMCH routes the access to hub interface or legacy I/O registers supported by the internal graphics device. The GMCH contains two internal registers in the processor I/O space, Configuration Address Register (CONF_ADDR) and the Configuration Data Register (CONF_DATA). These locations are used to implement PCI configuration space access mechanism and as described in this document.
- The processor allows 64K+3 bytes to be addressed within the I/O space. The GMCH propagates the processor I/O address without any translation on to the destination bus and, therefore, provides addressability for 64K+3 byte locations. Note that the upper 3 locations can be accessed only during I/O address wrap-around when processor bus A16# address signal is asserted. A16# is asserted on the processor bus when an I/O access is made to 4 bytes from address 0FFFDh, 0FFFEh, or 0FFFFh. A16# is also asserted when an I/O access is made to 2 bytes from address 0FFFFh.
- The I/O accesses, other than ones used for PCI configuration space access or ones that target the internal graphics device (or AGP/PCI) are forwarded to the hub interface. The GMCH will not post I/O write cycles to IDE. The PCICMD1 or PCICMD2 register can disable the routing of I/O cycles to the AGP.
- The GMCH never responds to I/O cycles initiated on AGP.

4.3.1. GMCH Decode Rules and Cross-Bridge Address Mapping

The GMCH's address map applies globally to accesses arriving on any of the three interfaces (i.e., Host bus, hub interface or from the internal graphics device).

4.3.2. Address Decode Rules

The GMCH accepts all memory read and write accesses from the hub interface to both system memory and graphics memory. The hub interface accesses that fall elsewhere within the PCI memory range will not be accepted. The GMCH never responds to hub interface initiated I/O read or write cycles.

The GMCH accepts accesses from the hub interface to the following address ranges:

- All memory read and write accesses to main DRAM including PAM region (except SMM space)
- All memory read/write accesses to the graphics aperture (DRAM) defined by APBASE and APSIZE.
- All hub interface memory write accesses to AGP memory range defined by MBASE, MLIMIT, PMBASE, and PMLIMIT.
- Memory writes to VGA range on AGP, if enabled.

The hub interface memory accesses that fall elsewhere within the memory range are considered invalid and will be remapped to a translated memory address, snooped on the host bus, and dispatched to DRAM. Reads will return all 1s with Master Abort completion. Writes will have byte enables deasserted and will terminate with Master Abort, if completion is required. I/O cycles will not be accepted. They are terminated with Master Abort completion packets.

The Hub Interface Accesses to GMCH that Cross Device Boundaries

The hub interface accesses are limited to 256 bytes but have no restrictions on crossing address boundaries. A single hub interface request may, therefore, span device boundaries (AGP, DRAM) or cross from valid addresses to invalid addresses (or vice versa). The GMCH does not support transactions that cross device boundaries. For reads and for writes requiring completion, the GMCH provides separate completion status for each naturally-aligned 32 or 64 byte block. If the starting address of a transaction hits a valid address, the portion of a request that hits that target device (AGP or DRAM) will complete normally.

The remaining portion of the access that crosses a device boundary (targets a different device than that of the starting address) or hits an invalid address will be remapped to memory address 0h, snooped on the host bus, and dispatched to DRAM. Reads will return all 1s with Master Abort completion. Writes will have byte enables deasserted and will terminate with Master Abort if completion is required.

If the starting address of a transaction hits an invalid address, the entire transaction will be remapped to memory address 0h, snooped on the host bus, and dispatched to DRAM. Reads will return all 1s with Master Abort completion. Writes will have byte enables deasserted and will terminate with Master Abort if completion is required.

4.3.2.1. AGP Interface Decode Rules

Cycles Initiated Using PCI Protocol

The GMCH does not support any AGP/PCI access targeting the hub interface. The GMCH will claim AGP/PCI initiated memory read and write transactions decoded to the main DRAM range or the graphics Aperture range. All other memory read and write requests will be master-aborted by the AGP/PCI initiator as a consequence of the GMCH not responding to a transaction.

Under certain conditions, the GMCH restricts access to the DOS compatibility ranges governed by the PAM registers by distinguishing access type and destination bus. The GMCH accepts AGP/PCI write transactions to the compatibility ranges if the PAM designates DRAM as write-able. If accesses to a range are not write enabled by the PAM, the GMCH does not respond and the cycle results in a master-abort. AGP/PCI read transactions to the compatibility ranges are accepted if the PAM designates DRAM as readable. If accesses to a range are not read enabled by the PAM, the GMCH does not respond and the cycle will result in a master-abort.

If agent on AGP/PCI issues an I/O or PCI Special Cycle transaction, the GMCH does not respond and cycle results in a master-abort. The GMCH does not accept PCI configuration cycles to the internal GMCH devices.

Cycles Initiated Using AGP Protocol

All cycles must reference main memory—main DRAM address range (*excluding* PAM) or graphics aperture range (also physically mapped within DRAM but using different address range). AGP accesses to the PAM region from 640 KB –to- 1 MB are not allowed. AGP accesses to SMM space are not allowed. AGP-initiated cycles that target DRAM are not snooped on the host bus, even if they fall outside of the AGP aperture range.

If a cycle is outside of a valid main memory range, then it will terminate as follows:

- Reads: Remap to memory address 0h, return data from address 0h, and set the IAAF error flag.
- Writes: Remapped to memory address 0h with byte enables deasserted (effectively dropped “on the floor”) and set the IAAF error flag.

AGP Accesses to GMCH that Cross Device Boundaries

For FRAME# accesses, when an AGP or PCI master gets disconnected, it will resume at the new address that allows the cycle to be routed to or claimed by the new target. Therefore, accesses should be disconnected by the target on potential device boundaries. The GMCH disconnects AGP/PCI transactions on 4 KB boundaries.

AGP PIPE# and SBA accesses are limited to 256 bytes and must hit DRAM. AGP accesses are dispatched to DRAM on naturally aligned 32-byte block boundaries. The portion of the request that hits a valid address completes normally. The portion of a read access that hits an invalid address is remapped to address 0h, returns data from address 0h, and sets the IAAF error flag. The portion of a write access that hits an invalid address is remapped to memory address 0h with byte enables deasserted (effectively dropped “on the floor”) and set the IAAF error flag.

4.3.2.2. Legacy VGA Ranges

The legacy VGA memory range A0000h–BFFFFh is mapped either to the hub interface or to AGP/PCI1 depending on the programming of the VGA Enable bit in the BCTRL configuration register in GMCH Device #1 configuration space, and the MDAP bit in the GMCHCFG configuration register in Device #0 configuration space. The same register controls mapping VGA I/O address ranges. The VGA I/O range is defined as addresses where A[9:0] are in the ranges 3B0h to 3BBh and 3C0h to 3DFh (inclusive of ISA address aliases: A[15:10] are not decoded). The function and interaction of these two bits is described below:

MDA Present (MDAP): This bit works with the VGA Enable bit in the BCTRL register of device 1 to control the routing of processor-initiated transactions targeting MDA compatible I/O and memory address ranges. This bit should not be set when the VGA Enable bit is not set. If the VGA enable bit is set, accesses to IO address range x3BCh–x3BFh are forwarded to the hub interface. If the VGA enable bit is not set, I/O address range accesses x3BCh–x3BFh are treated like other I/O accesses (the cycles are forwarded to AGP if the address is within IOBASE and IOLIMIT and ISA enable bit is not set); otherwise, they are forwarded to the hub interface. MDA resources are defined as the following:

Memory: 0B0000h–0B7FFFh

I/O: 3B4h, 3B5h, 3B8h, 3B9h, 3BAh, 3BFh,
(including ISA address aliases, A[15:10] are not used in decode)

Any I/O reference that includes the I/O locations listed above, or their aliases, are forwarded to the hub interface, even if the reference includes I/O locations not listed above.

VGA Enable: Controls the routing of processor-initiated transactions targeting VGA compatible I/O and memory address ranges. When this bit is set, the GMCH forwards the following processor accesses to AGP:

- Memory accesses in the range 0A0000h to 0BFFFFh
- I/O addresses where A[9:0] are in the ranges 3B0h to 3BBh and 3C0h to 3DFh (inclusive of ISA address aliases: A[15:10] are not decoded)

When this bit is set, forwarding of these accesses issued by the processor is independent of the I/O address and memory address ranges defined by the previously defined Base and Limit registers. Forwarding of these accesses is also independent of the settings of bit 2 (ISA Enable) of BCTRL if this bit is 1. If the VGA enable bit is set, accesses to I/O address range x3BCh–x3BFh are forwarded to the hub interface. If the VGA enable bit is not set, I/O address range accesses x3BCh–x3BFh are treated like other I/O accesses (the cycles are forwarded to AGP, if the address is within IOBASE and IOLIMIT and ISA enable bit is not set); otherwise, they are forwarded to the hub interface.

If this bit is 0 (default), VGA compatible memory and I/O range accesses are not forwarded to AGP; rather, they are mapped to the hub interface, unless they are mapped to AGP via I/O and memory range registers defined above (IOBASE, IOLIMIT, MBASE, MLIMIT, PMBASE, PMLIMIT).

The following table shows the behavior for all combinations of MDA and VGA:

VGA	MDA	Behavior
0	0	All references to MDA and VGA go to the hub interface
0	1	Illegal combination (DO NOT USE)
1	0	All references to VGA Go To AGP/PCI. MDA-only references (I/O Address 3BFh and aliases) will go to the hub interface.
1	1	VGA references go to AGP/PCI; MDA references go to the hub interface.

4.4. Host Interface

The host interface of the GMCH is optimized to support the Intel® Pentium III processor, Intel® Pentium II processor, and Intel® Celeron™ processor. The GMCH implements the host address, control, and data bus interfaces within a single device. The GMCH supports a 4-deep in-order queue (i.e., supports pipelining of up to 4 outstanding transaction requests on the host bus). Host bus addresses are decoded by the GMCH for accesses to system memory, PCI memory and PCI I/O (via hub interface), PCI configuration space, and graphics memory. The GMCH takes advantage of the pipelined addressing capability of the processor to improve the overall system performance. The GMCH supports the 370-pin socket processor connector.

4.4.1. Host Bus Device Support

The GMCH recognizes and supports a large subset of the transaction types that are defined for the Intel® Pentium III processor, Intel® Pentium II processor, or Intel® Celeron™ processor bus interface. However, each of these transaction types have a multitude of response types, some of which are not supported by this controller. All transactions are processed in the order that they are received on the processor bus.

Table 10. Summary of Transactions Supported By GMCH

Transaction	REQa[4:0]#	REQb[4:0]#	GMCH Support
Deferred Reply	0 0 0 0 0	X X X X X	The GMCH will initiate a deferred reply request for a previously deferred transaction.
Reserved	0 0 0 0 1	X X X X X	Reserved
Interrupt Acknowledge	0 1 0 0 0	0 0 0 0 0	Interrupt acknowledge cycles are forwarded to the hub interface.
Special Transactions	0 1 0 0 0	0 0 0 0 1	See separate table in special cycles section.
Reserved	0 1 0 0 0	0 0 0 1 x	Reserved
Reserved	0 1 0 0 0	0 0 1 x x	Reserved
Branch Trace Message	0 1 0 0 1	0 0 0 0 0	The GMCH will terminate a branch trace message without latching data.
Reserved	0 1 0 0 1	0 0 0 0 1	Reserved
Reserved	0 1 0 0 1	0 0 0 1 x	Reserved
Reserved	0 1 0 0 1	0 0 1 x x	Reserved
I/O Read	1 0 0 0 0	0 0 x LEN#	I/O read cycles are forwarded to hub interface. I/O cycles that are in the GMCH configuration space are not forwarded to the hub interface.
I/O Write	1 0 0 0 1	0 0 x LEN#	I/O write cycles are forwarded to hub interface. I/O cycles that are in the GMCH configuration space are not forwarded to the hub interface.
Reserved	1 1 0 0 x	0 0 x x x	Reserved
Memory Read & Invalidate	0 0 0 1 0	0 0 x LEN#	Host initiated memory read cycles are forwarded to DRAM or the hub interface.
Reserved	0 0 0 1 1	0 0 x LEN#	Reserved

Transaction	REQa[4:0]#	REQb[4:0]#	GMCH Support
Memory Code Read	0 0 1 0 0	0 0 x LEN#	Memory code read cycles are forwarded to DRAM or the hub interface.
Memory Data Read	0 0 1 1 0	0 0 x LEN#	Host-initiated memory read cycles are forwarded to DRAM or the hub interface.
Memory Write (no retry)	0 0 1 0 1	0 0 x LEN#	This memory write is a writeback cycle and cannot be retried. The GMCH forwards the write to DRAM.
Memory Write (can be retried)	0 0 1 1 1	0 0 x LEN#	The standard memory write cycle is forwarded to DRAM or the hub interface.

NOTES:

- For Memory cycles, REQa[4:3]# = ASZ#. GMCH only supports ASZ# = 00 (32 bit address).
- REQb[4:3]# = DSZ#. DSZ# = 00 (64 bit data bus size).
- LEN# = data transfer length as follows:

LEN#	Data length
00	<= 8 bytes (BE[7:0]# specify granularity)
01	Length = 16 bytes BE[7:0]# all active
10	Length = 32 bytes BE[7:0]# all active
11	Reserved

Table 11. Host Responses Supported by the GMCH

RS2#	RS1#	RS0#	Description	GMCH Support
0	0	0	idle	
0	0	1	Retry Response	This response is generated if an access is to a resource that cannot be accessed by the processor at this time and the logic must avoid deadlock . Hub interface directed reads, writes, and DRAM locked reads can be retried.
0	1	0	Deferred Response	This response can be returned for all transactions that can be executed 'out of order.' Hub interface directed reads (memory, I/O and Interrupt Acknowledge) and writes (I/O only), and internal Graphics device directed reads (memory and I/O) and writes (I/O only) can be deferred.
0	1	1	Reserved	Reserved
1	0	0	Hard Failure	Not supported.
1	0	1	No Data Response	This is for transactions where the data has already been transferred or for transactions where no data is transferred. Writes and zero length reads receive this response.
1	1	0	Implicit Writeback	This response is given for those transactions where the initial transactions snoop hits on a modified cache line.
1	1	1	Normal Data Response	This response is for transactions where data accompanies the response phase. Reads receive this response.

4.4.2. Special Cycles

A Special Cycle is defined when $REQa[4:0] = 01000$ and $REQb[4:0] = xx001$. The first address phase $Aa[35:3]\#$ is undefined and can be driven to any value. The second address phase, $Ab[15:8]\#$ defines the type of Special Cycle issued by the processor.

Table 12 specifies the cycle type and definition as well as the action taken by the GMCH when the corresponding cycles are identified.

Table 12. Special Cycles

BE[7:0]#	Special Cycle Type	Action Taken
0000 0000	NOP	This transaction has no side-effects.
0000 0001	Shutdown	This transaction is issued when an agent detects a severe software error that prevents further processing. This cycle is claimed by the GMCH. The GMCH issues a shutdown special cycle on the hub interface. This cycle is retired on the processor bus after it is terminated on the hub interface via a master abort mechanism.
0000 0010	Flush	This transaction is issued when an agent has invalidated its internal caches without writing back any modified lines. The GMCH claims this cycle and retires it.
0000 0011	Halt	This transaction is issued when an agent executes a HLT instruction and stops program execution. This cycle is claimed by the GMCH and propagated to the hub interface as a Special Halt Cycle. This cycle is retired on the processor bus after it is terminated on the hub interface via a master abort mechanism.
0000 0100	Sync	This transaction is issued when an agent has written back all modified lines and has invalidated its internal caches. The GMCH claims this cycle and retires it.
0000 0101	Flush Acknowledge	This transaction is issued when an agent has completed a cache sync and flush operation in response to an earlier FLUSH# signal assertion. The GMCH claims this cycle and retires it.
0000 0110	Stop Clock Acknowledge	This transaction is issued when an agent enters Stop Clock mode. This cycle is claimed by the GMCH and propagated to the hub interface as a Special Stop Grant Cycle. This cycle is completed on the processor bus after it is terminated on the hub interface via a master abort mechanism.
0000 0111	SMI Acknowledge	This transaction is first issued when an agent enters the System Management Mode (SMM). $Ab[7]\#$ is also set at this entry point. All subsequent transactions from the processor with $Ab[7]\#$ set are treated by the GMCH as accesses to the SMM space. No corresponding cycle is propagated to the hub interface. To exit the System Management Mode the processor issues another one of these cycles with the $Ab[7]\#$ bit deasserted. The SMM space access is closed by the GMCH at this point.
All others	Reserved	

4.5. System Memory DRAM Interface

The GMCH integrates a system DRAM controller that supports a 64-bit DRAM array. The DRAM type supported is synchronous (SDRAM). The GMCH generates the SCSA#, SCSB#, SDQM, SCAS#, SRAS#, SWE# and multiplexed addresses, SMA for the DRAM array. The GMCH's DRAM interface operates at a clock frequency of either 100 or 133 MHz, dependent upon the system bus interface clock frequency. The DRAM controller interface is fully configurable through a set of control registers. Complete descriptions of these registers are given in the register description section of this document.

The GMCH supports industry standard 64-bit wide DIMM modules with SDRAM devices. The 2 bank select lines (SBS[1:0]), the 12 address lines (SMAA[11:0]), and copies of 4 address lines (SMAB[7:4]# and SMAC[7:4]#) allow the GMCH to support 64-bit wide DIMMs using 16Mb, 64Mb, or 128Mb technology SDRAMs. The GMCH has a sufficient amount of SCS# lines to enable the support of up to six 64-bit rows of DRAM. For write operations of less than a QWord, the GMCH performs a byte-wise write. The GMCH targets SDRAM with CL2 and CL3 and supports both single and double-sided DIMMs. The GMCH provides refresh functionality with programmable rate (normal DRAM rate is 1 refresh/15.6 μ s). The GMCH can be configured via the Page Closing Policy Bit in the GMCH Configuration Register to keep multiple pages open within the memory array. Pages can be kept open in any one row of memory. Up to 4 pages can be kept open within that row (The GMCH only supports 4 Bank SDRAMs on system DRAM interface).

4.5.1. DRAM Organization and Configuration

The GMCH supports 64-bit DRAM configurations. In the following discussion the term row refers to a set of memory devices that are simultaneously selected by a SCS# signal. The GMCH supports a maximum of 6 rows of memory. Both single-sided and double-sided DIMMs are supported.

The interface consists of the following pins:

Multiple copies: SMAA[7:4], SMAB[7:4]# , SMAC[7:4]#

Single Copies: SMD[63:0]
SDQM[7:0]
SMAA[12:8,3:0]
SBS[1:0]
SCSA[5:0]#
SCSB[5:0]#
SCAS#
SRAS#
SWE#
SCKE[1:0]

The GMCH supports DIMMs populated with 8, 16, and 32 bit wide SDRAM devices. Registered DIMMs or DIMMs populated with 4 bit wide SDRAM devices are not supported. The GMCH supports 3.3V standard SDRAMs.

Table 13 illustrates a sample of the possible DIMM socket configurations along with corresponding DRP programming. See the register section of this document for a complete DRP programming table.

Table 13. Sample Of Possible Mix And Match Options For 4 Row/2 DIMM Configurations

DIMM0	DIMM1	DRP	Total Memory
0	4x(4M x 16) S	70	32 MB
4x (4M x16) S	0	07	32 MB
4x(4Mx16) + 2x(2Mx32) D	0	08	48 MB
4x(4Mx16) S	4x(4Mx16) S	77	64 MB
8x(8Mx8) + 4x(4Mx16) D	0	0B	96 MB
8x(8Mx8) D	0	0C	128 MB
8x(8Mx8) D	8x(8Mx8) D	CC	256 MB

NOTES:

1. "S" denotes single-sided DIMMs, "D" denotes double-sided DIMMs.

4.5.1.1. Configuration Mechanism For DIMMs

Detection of the type of DRAM installed on the DIMM is supported via Serial Presence Detect mechanism as defined in the JEDEC 168-pin DIMM standard. This standard uses the SCL, SDA and SA[2:0] pins on the DIMMs to detect the type and size of the installed DIMMs. No special programmable modes are provided on the GMCH for detecting the size and type of memory installed. Type and size detection must be done via the serial presence detection pins. Use of Serial Presence Detection is required.

Memory Detection and Initialization

Before any cycles to the memory interface can be supported, the GMCH DRAM registers must be initialized. The GMCH must be configured for operation with the installed memory types. Detection of memory type and size is done via the System Management Bus (SMBus) interface on the I/O Controller Hub. This two wire bus is used to extract the DRAM type and size information from the serial presence detect port on the DRAM DIMM modules.

DRAM DIMM modules contain a 5-pin serial presence detect interface, including SCL (serial clock), SDA (serial data) and SA[2:0]. Devices on the SMBus bus have a seven bit address. For the DRAM DIMM modules, the upper four bits are fixed at 1010. The lower three bits are strapped on the SA[2:0] pins. SCL and SDA are connected directly to the System Management Bus on the I/O Controller Hub. Thus, data is read from the Serial Presence Detect port on the DRAM DIMM modules via a series of IO cycles to the I/O Controller Hub. BIOS essentially needs to determine the size and type of memory used for each of the four rows of memory in order to properly configure the GMCH system memory interface.

SMBus Configuration and Access of the Serial Presence Detect Ports

For more details on this, see the *Intel® 82801AA (ICH) and Intel® 82801AB (ICH0) I/O Controller Hub* datasheet or *Intel® 82801BA (ICH2) I/O Controller Hub* datasheet..

4.5.1.2. DRAM Register Programming

This section provides an overview of how the required information for programming the DRAM registers is obtained from the Serial Presence Detect ports on the DIMMs. The Serial Presence Detect ports are used to determine Refresh Rate, MA and MD Buffer Strength, Row Type (on a row by row basis), SDRAM Timings, Row Sizes and Row Page Sizes. Table 14 lists a subset of the data available through the on-board Serial Presence Detect ROM on each DIMM module.

Table 14. Data Bytes on DIMM Used for Programming DRAM Registers

Byte	Function
2	Memory Type (EDO, SDRAM) the GMCH only supports SDRAM.
3	# of Row Addresses, not counting Bank Addresses
4	# of Column Addresses
5	# of banks of DRAM (Single or Double sided) DIMM
12	Refresh Rate
17	# Banks on each SDRAM Device
36–41	Access Time from Clock for CAS# Latency 1 through 7
42	Data Width of SDRAM Components

Table 14 is only a subset of the defined SPD bytes on the DIMM module. These bytes collectively provide enough data for BIOS to program the GMCH DRAM registers.

4.5.2. DRAM Address Translation and Decoding

The GMCH translates the address received on the host bus, hub interface, or from the internal graphics device to an effective memory address. The GMCH supports 16 Mbit and 64 Mbit SDRAM devices. The GMCH supports a 2 KB page sizes only. The multiplexed row / column address to the DRAM memory array is provided by the SBS[1:0] and SMAA[11:0] signals and copies. These addresses are derived from the host address bus as defined by the following table for SDRAM devices.

- Row size is internally computed using the values programmed in the DRP register.
- Up to 4 pages can be open at any time within any row (Only 2 active pages are supported in rows populated with either 8 MBs or 16 MBs).

Table 15. GMCH DRAM Address Mux Function

Tech (Mb)	Depth	Width	Address Usage			Mem Size (MB)	BS	BS	MA	MA	MA	MA	MA	MA	MA	MA	MA	MA	MA	MA	
			Row	Col	Bank		1	0	12	11	10	9	8	7	6	5	4	3	2	1	0
16	2M	8	11	9	1	16	X	11	X	X	[A]	22	21	20	19	18	17	16	15	14	13
							X	11	X	X	PA	X	23	10	9	8	7	6	5	4	3
64	8M	8	12	9	2	64	12	11	X	24	[A]	22	21	20	19	18	17	16	15	14	13
							12	11	X	X	PA	X	25	10	9	8	7	6	5	4	3
64	4M	16	12	8	2	32	12	11	X	24	[A]	22	21	20	19	18	17	16	15	14	13
							12	11	X	X	PA	X	X	10	9	8	7	6	5	4	3
128	16M	8	12	10	2	128	12	11	X	24	[A]	22	21	20	19	18	17	16	15	14	13
							12	11	X	X	PA	26	25	10	9	8	7	6	5	4	3
128	8M	16	12	9	2	64	12	11	X	24	[A]	22	21	20	19	18	17	16	15	14	13
							12	11	X	X	PA	X	25	10	9	8	7	6	5	4	3
256	32M	8	13	10	2	256	12	11	27	24	[A]	22	21	20	19	18	17	16	15	14	13
							12	11	X	X	PA	26	25	10	9	8	7	6	5	4	3
256	16M	16	13	9	2	128	12	11	26	24	[A]	22	21	20	19	18	17	16	15	14	13
							12	11	X	X	PA	X	25	10	9	8	7	6	5	4	3

NOTES: MA bit 10 at RAS time uses the XOR of Address bit 12 and Address bit 23

4.5.3. DRAM Array Connectivity

Figure 6. DRAM Array Sockets

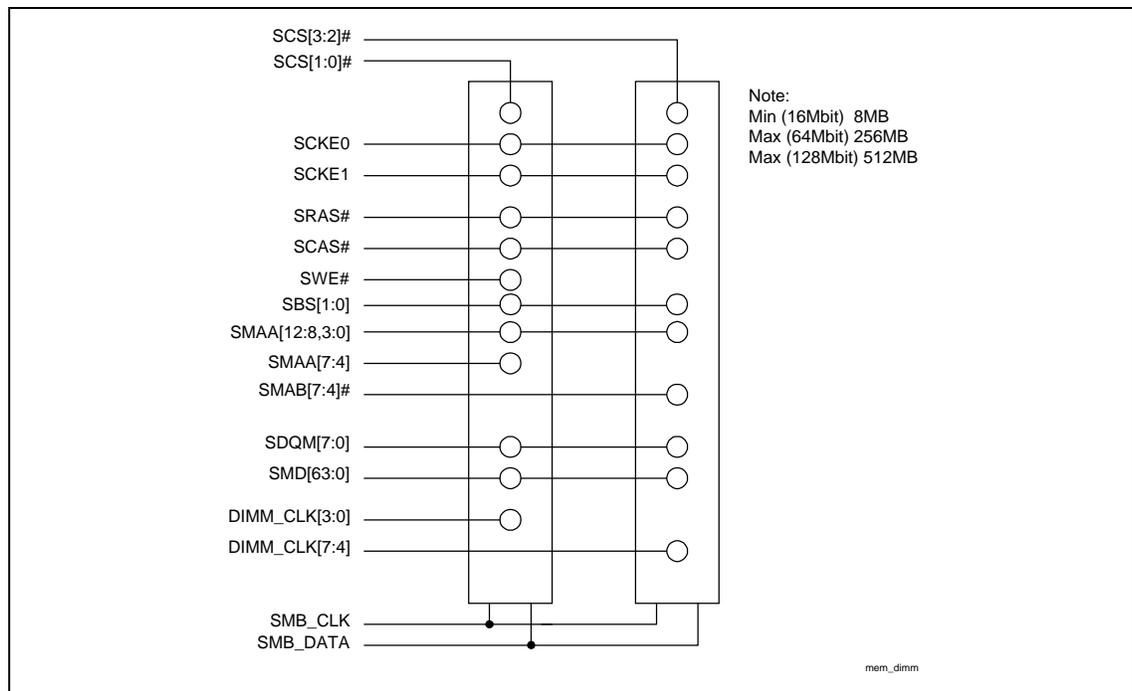

4.5.4. SDRAM Register Programming

Several DRAM timing parameters are programmable in the GMCH configuration registers. Table 16 summarizes the programmable parameters.

Table 16. Programmable SDRAM Timing Parameters

Parameter	DRAMT Bit	Values (SCLKs)
RAS# Precharge (SRP)	0	2,3
RAS# to CAS# Delay (SRCD)	1	2,3
CAS# Latency (CL)	2	2,3
DRAM Cycle Time (DCT)	4	Tras = 5,6 Trc = 7,8

These parameters are controlled via the DRAMT register. To support different device speed grades, CAS# Latency, RAS# to CAS# Delay, and RAS# Precharge are all programmable as either two or three SCLKs. To provide flexibility, these are each controlled by separate register bits (i.e., the GMCH can support any combination of CAS# Latency, RAS#-to-CAS# Delay and RAS# Precharge).

4.5.5. SDRAM Paging Policy

The GMCH can maintain up to 4 active pages in any one row; however, the GMCH does not support active pages in more than 1 row at a time.

The DRAM page closing policy (DPCP) in the GMCH configuration register (GMCHCFG) controls the page closing policy of the GMCH. This bit controls whether the GMCH “precharges bank” or “precharges all” during the service of a page miss. When this bit is 0, the GMCH precharges bank during the service of a page miss. When this bit is 1, the GMCH precharges all during the service of a page miss.

4.6. Intel® Dynamic Video Memory Technology (D.V.M.T.)

The internal graphics device on the GMCH supports Intel® Dynamic Video Memory Technology (D.V.M.T.). D.V.M.T. dynamically responds to application requirements by allocating the proper amount of display and texturing memory. For more details, refer to the document entitled, “*Intel® 810 Chipset: Great Performance for Value PCs*” available at:

<http://developer.intel.com/design/chipsets/810/810white.htm>.

In addition to D.V.M.T., the GMCH supports Display Cache (DC). The graphics engine of the GMCH uses DC for implementing rendering buffers (e.g., Z buffers). This rendering model requires 4 MB of display cache and allows graphics rendering (performed across the graphics display cache bus) and texture MIP map access (performed across the system memory bus) simultaneously. In using D.V.M.T., all graphics rendering is implemented in system memory. The system memory bus is arbitrated between texture MIP-map accesses and rendering functions.

4.7. Display Cache Interface

The GMCH Display Cache (DC) is a single channel 32-bit wide SDRAM interface. The GMCH handles the control and timing for the display cache. The display cache interface of the GMCH generates the LCS#, LDQM[7:0], LSCAS#, LSRAS#, LWE#, LMD[31:0] and multiplexed addresses, LMA[11:0] for the display cache DRAM array. The GMCH also generates the clock LTCLK[1:0] for write cycles as well as LOCLK for read cycle timings.

The display cache interface of the GMCH supports single data rate synchronous dynamic random access memory (SDRAM). It supports a single 32-bit wide memory channel. The interface handles the operation of D.V.M. with DC at 133 MHz. The DRAM controller interface is fully configurable through a set of control registers.

Internal buffering (FIFOs) of the data to and from the display cache ensures the synchronization of the data to the internal pipelines. The D.V.M. with DC interface clocking is divided synchronous with respect to the core and system bus.

The display cache resides on an AGP In-Line Memory Module (AIMM). The startup sequencing for the AIMM (which is interfaced via the AGP connector), is as follows:

1. System BIOS detects if an AGP card is present by performing a configuration read to PCI. If an AGP card is present, it becomes the display device and bit 0 of the APCONT register should be set to 0. No further initialization of internal graphics will take place. If internal graphics is the preferred display device, bit 0 of the APCONT register should be set to 1. If no AGP card is present, the internal graphics becomes the display device and bit 0 of the APCONT register should be set to 1. PCI enumeration takes place at this point.

In the case where internal graphics is selected, the remaining steps still apply:

2. System BIOS determines if an AIMM card (local memory) is present.

If the AIMM card is present, the following steps take place:

3. Local Memory Clock Frequency is determined with a reset strap (on AGP pin SBA[7]) sampled as an input during reset.
4. Memory Timing Options will be determined empirically by the system BIOS. BIOS will start with programming slow timings (CAS Latency, RAS Pre-charge, etc.) and then trying faster timings until it breaks. The settings that optimize performance without compromising functionality will be selected.

4.7.1. Supported DRAM Types for Display Cache Memory

The GMCH supports 1Mx16 and 2Mx32 SDRAMs; however, the GMCH only supports 4 MB of display cache.

4.7.2. Memory Configurations

Table 17 provides a summary of the characteristics of memory configurations supported. The GMCH supports a 32-bit wide channel populated with a single row of 1Mx16 SDRAMs.

Table 17. Memory Size for each configuration :

SDRAM	SDRAM	SDRAM	# of	Address Size			DRAM	DRAM Size
Tech.	Density	Width	Banks	Bank	Row	Column	Addressing	
16 Mbit	1M	16	2	1	11	8	Asymmetric	4 MB
16 Mbit	1M	32						

The following figure shows the GMCH LMI connected to 4 MB of memory in a 32-bit SDRAM channel configuration.

Figure 7. GMCH Display Cache Interface to 4 MB

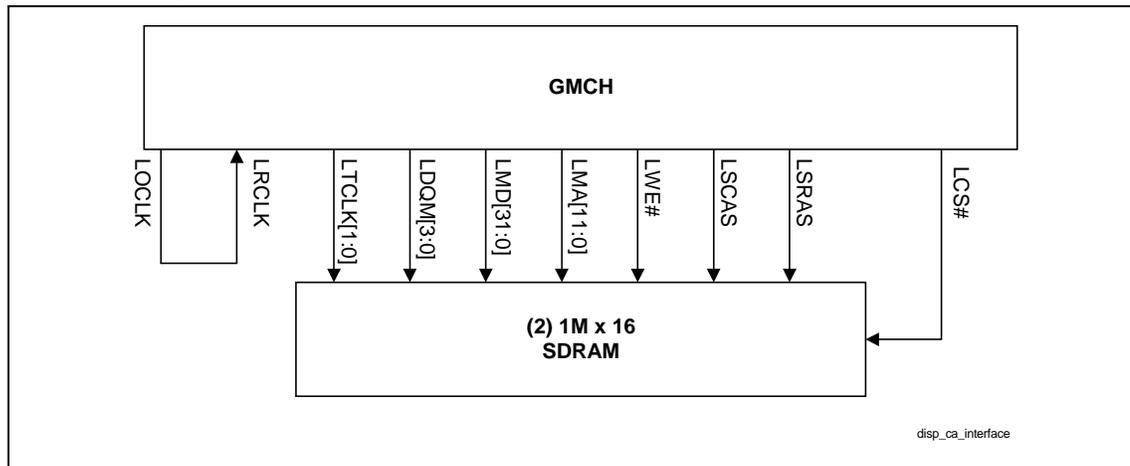

4.7.3. Address Translation

The GMCH contains address decoders that translate the address received by the display cache into an effective display cache address. The LMA[11:0] bits are as defined below. Entries in the table (e.g., A21(X)) imply that the GMCH puts out A21 on that MA line but it is not used by the SDRAM.

Table 18. GMCH Local Memory Address Mapping

MA	1Mx16	
	Row	Column
11(BA)	A10	A10
10	A11	X
9	A21	X
8	A20	X
7	A19	A9
6	A18	A8
5	A17	A7
4	A16	A6
3	A15	A5
2	A14	A4
1	A13	A3
0	A12	A2

BA = Bank address

4.7.4. Display Cache Interface Timing

The GMCH provides a variety of programmable wait states for DRAM read and write cycles. These options are programmed in the display cache I/O addresses of the GMCH configuration space. The wrap type and the burst length is implied since they are not programmable and fixed. Only sequential wrap is allowed. Burst length is fixed at two.

4.8. Internal Graphics Device

4.8.1. 3D/2D Instruction Processing

The GMCH contains an extensive set of instructions that control various functions including 3D rendering, BLT and STRBLT operations, display, motion compensation, and overlay. The 3D instructions set 3D pipeline states and control the processing functions. The 2D instructions provide an efficient method for invoking BLT and STRBLT operations.

The graphics controller executes instructions from one of two instruction buffers located in system memory: Interrupt Ring or Low Priority Ring. Instead of writing instructions directly to the GMCH's graphics controller, software sets up instruction packets in these memory buffers and then instructs the GMCH to process the buffers. The GMCH uses DMAs to put the instructions into its FIFO and executes them. Instruction flow in the ring buffer instruction stream can make calls to other buffers, much like a software program makes subroutine calls. Flexibility has been built into the ring operation permitting software to efficiently maintain a steady flow of instructions.

Batching instructions in memory ahead of time and then instructing the graphics controller to process the instructions provides significant performance advantages over writing directly to FIFOs including: 1) Reduced software overhead, 2) Efficient DMA instruction fetches from graphics memory, and 3) Software can more efficiently set up instruction packets in buffers in graphics memory (faster than writing to FIFOs).

Figure 8. 3D/2D Pipeline Preprocessor

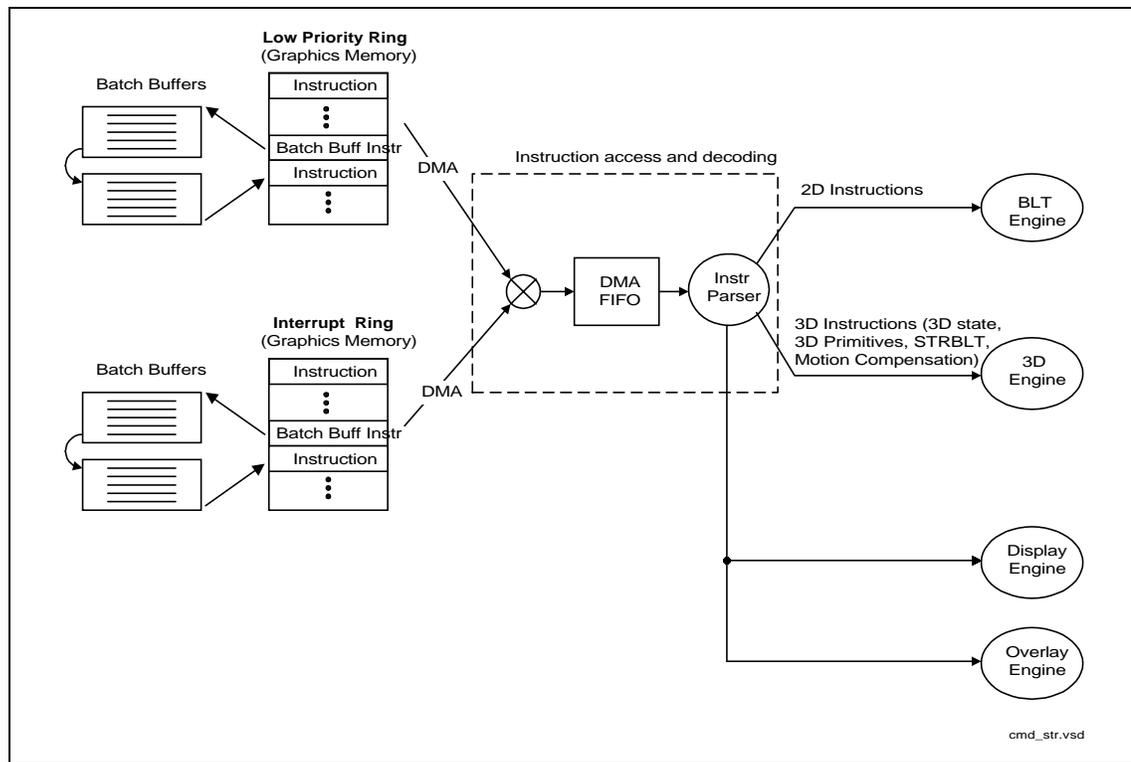

4.8.2. 3D Engine

The 3D engine of the GMCH has been architected as a deep pipeline, where performance is maximized by allowing each stage of the pipeline to simultaneously operate on different primitives or portions of the same primitive. The GMCH supports perspective-correct texture mapping, bilinear, trilinear, and anisotropic MIP map filtering, Gouraud shading, alpha-blending, colorkeying and chromakeying, full color specular shading, fogging and Z Buffering. These features can be independently enabled or disabled via a set of 3D instructions. In addition, the GMCH supports a Dynamic Video Memory Technology (D.V.M.T.) that allows the entire 3D rendering process to take place in system memory; thus, alleviating the need for the display cache.

The main blocks of the pipeline are the Setup Engine, Scan Converter, Texture Pipeline, and Color Calculator block. A typical programming sequence would be to send instructions to set the state of the pipeline followed by rendering instructions containing 3D primitive vertex data.

4.8.3. Buffers

The 2D, 3D, and video capabilities of the GMCH provide control over a variety of graphics buffers that can be implemented either in display cache or system memory. To aid the rendering process, the display cache of the GMCH contains two hardware buffers—the Front Buffer (display buffer) and the Back Buffer (rendering buffer). The image being drawn is not visible until the scene is complete and the back buffer made visible (via an instruction) or copied to the front buffer (via a 2D BLT operation). By rendering to one and displaying from the other, the possibility of image tearing is removed. This also speeds up the display process over a single buffer.

The 3D pipeline of the GMCH operates on the Back Buffer and the Z Buffer. The pixels' 16-bit (or 15-bit) RGB colors are stored in the back buffer. The Z-buffer can be used to store 16-bit depth values or 5-bit “destination alpha” values. The instruction set of the GMCH provides a variety of controls for the buffers (e.g., initializing, flip, clear, etc.).

Figure 9. Data Flow for the 3D Pipeline

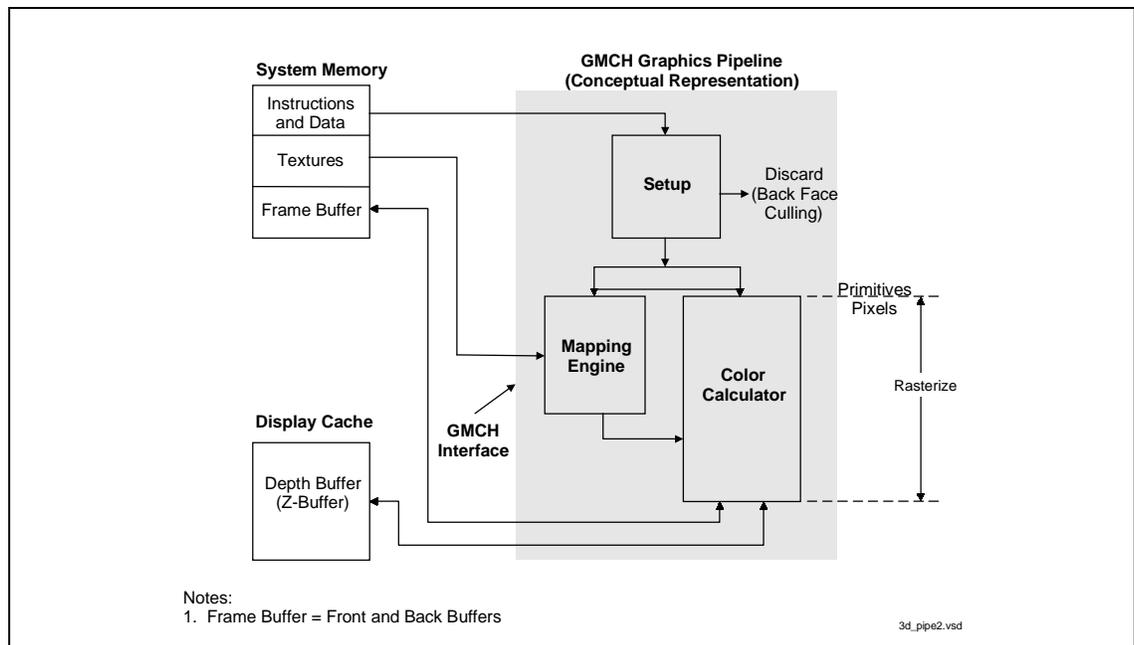

4.8.4. Setup

The setup stage of the pipeline takes the input data associated with each vertex of the line or triangle primitive and computes the various parameters required for scan conversion. In formatting this data, the GMCH maintains sub-pixel accuracy. Data is dynamically formatted for each rendered polygon and output to the proper processing unit. As part of the setup, the GMCH removes polygons from further processing, if they are not facing the user's viewpoint (referred to as "Back Face Culling").

4.8.5. Texturing

The GMCH allows an image, pattern, or video to be placed on the surface of a 3D polygon. Textures must be located in system memory. Being able to use textures directly from system memory means that large complex textures can easily be handled without the limitations imposed by the traditional approach of only using the display cache.

The texture processor receives the texture coordinate information from the setup engine and the texture blend information from the scan converter. The texture processor performs texture color or chroma-key matching, texture filtering (anisotropic, bilinear, and trilinear interpolation), and YUV to RGB conversions.

The GMCH supports up to 11 Levels-of-Detail (LODs) ranging in size from 1024x1024 to 1x1 texels. (A texel is defined as a texture map pixel). Textures need not be square. Included in the texture processor is a small cache that provides efficient mip-mapping.

- **Nearest.** Texel with coordinates nearest to the desired pixel is used. (This is used if only one LOD is present).
- **Linear.** A weighted average of a 2x2 area of texels surrounding the desired pixel are used. (This is used if only one LOD is present).
- **Mip Nearest.** This is used if many LODs are present. The appropriate LOD is chosen and the texel with coordinates nearest to the desired pixel are used.
- **Mip Linear.** This is used if many LODs are present. The appropriate LOD is chosen and a weighted average of a 2x2 area of texels surrounding the desired pixel are used. This is also referred to as bilinear mip-mapping.
- **Trilinear.** Tri-linear filtering blends two mip maps of the same image to provide a smooth transition between different mips (floor and ceiling of the calculated LOD).
- **Anisotropic.** This can be used if multiple LODs are present. This filtering method improves the visual quality of texture-mapped objects when viewed at oblique angles (i.e., with a high degree of perspective foreshortening). The improvement comes from a more accurate (anisotropic) mapping of screen pixels onto texels – where using bilinear or trilinear filtering can yield overly-blurred results. Situations where anisotropic filtering demonstrates superior quality include text viewed at an angle, lines on roadways, etc.

The GMCH can store each of the above mip-maps in any of the following formats:

- 8bpt Surface Format
- 16bpt Surface Format
 - RGB 565
 - ARGB 1555
 - ARGB 4444
 - AY 88
- 8bpt (Indexed) Surface Format
 - RGB 565
 - ARGB 1555
 - ARGB 4444
 - AY 88
- 4:2:2
 - YcrCb, Swap Y Format
 - YcrCb, Normal
 - YcrCb, UV Swap
 - YcrCb, UV/Y Swap

Many texture mapping modes are supported. Perspective correct mapping is always performed. As the map is fitted across the polygon, the map can be tiled, mirrored in either the U or V directions, or mapped up to the end of the texture and no longer placed on the object (this is known as clamp mode). The way a texture is combined with other object attributes is also definable.

Texture ColorKey and ChromaKey

ColorKey and ChromaKey describe two methods of removing a specific color or range of colors from a texture map before it is applied to an object. For “nearest” texture filter modes, removing a color simply makes those portions of the object transparent (the previous contents of the back buffer show through). For “linear” texture filtering modes, the texture filter is modified if only the non-nearest neighbor texels match the key (range).

ColorKeying occurs with paletted textures, and removes colors according to an index (before the palette is accessed). When a color palette is used with indices to indicate a color in the palette, the indices can be compared against a state variable “ColorKey Index Value” and if a match occurs and ColorKey is enabled, then this value’s contribution is removed from the resulting pixel color. The GMCH defines index matching as ColorKey.

ChromaKeying can be performed for both paletted and non-paletted textures, and removes texels that fall within a specified color range. The ChromaKey mode refers to testing the RGB or YUV components to see if they fall between high and low state variable values. If the color of a texel contribution is in this range and chromaKey is enabled, then this contribution is removed from the resulting pixel color.

Multiple Texture Composition

The GMCH includes support for two simultaneous texture maps. This support greatly reduces the need for multipass compositing techniques for effects such as diffuse light maps, specular reflection maps, bump mapping, detail textures, gloss maps, shadows, and composited effects like dirt or tire marks. Supporting these techniques in hardware greatly increases compositing performance by reducing the need to read and write the frame buffer multiple times.

This multitexture support provides a superset of the “legacy” one-texture (pre-DirectX 6) texture blend modes and a large subset of the operations defined in DirectX 6 and the OpenGL ARB multitexture extensions.

The Multitexture Compositing Unit is capable of combining the interpolated vertex diffuse color, a constant color value, and up to two texels per pixel in a fully-programmable fashion. Up to three operations (combinations) can be performed in a pipelined organization, with intermediate storage to support complex equations (e.g., of the form “ $A*B + C*D$ ”) required for light maps and specular gloss maps. Separate operations can be performed on color (RGB) and alpha components.

4.8.6. 2D Operation

The GMCH contains BLT and STRBLT functionality, a hardware cursor, and an extensive set of 2D registers and instructions.

GMCH VGA Registers and Enhancements

The 2D registers are a combination of registers defined by IBM* when the Video Graphics Array (VGA) was first introduced, and others that Intel has added to support graphics modes that have color depths, resolutions, and hardware acceleration features that go beyond the original VGA standard. The GMCH improves upon VGA by providing additional features that are used through numerous additional registers.

The GMCH also supports an optional display cache. As an improvement on the VGA standard display cache port-hole, the GMCH also maps the entire display cache into part of a single contiguous memory space at a programmable location, providing what is called “linear” access to the display cache. The size of this memory can be up to 4 MB, and the base address is set via PCI configuration registers. Alternatively, these buffers may be implemented in system memory (via D.V.M.), thus alleviating the need for the display cache.

4.8.7. Fixed Blitter (BLT) and Stretch Blitter (STRBLT) Engines

The GMCH’s 64-bit BLT engine provides hardware acceleration for many common Windows* operations. The following are two primary BLT functions: Fixed Blitter (BLT) and Stretch Blitter (STRBLT). The term BLT refers to a block transfer of pixel data between memory locations. The word “fixed” is used to differentiate from the Stretch BLT engine. The BLT engine can be used for the following:

- Move rectangular blocks of data between memory locations
- Data alignment
- Perform logical operations

The GMCH has instructions to invoke BLT and STRBLT operations, permitting software to set up instruction buffers and use batch processing as described in the *3D/2D Instruction Processing* Section. Note that these instructions replace the need to do PIO directly to BLT and STRBLT registers, which speeds up the operation.

4.8.7.1. Fixed BLT Engine

The rectangular block of data does not change as it is transferred between memory locations. The allowable memory transfers are between: system memory and display cache, display cache and display cache, and system memory and system memory. Data to be transferred can consist of regions of memory, patterns, or solid color fills. A pattern will always be 8x8 pixels wide and may be 8, 16, or 24 bits per pixel.

The GMCH can expand monochrome data into a color depth of 8, 16, or 24 bits. BLTs can be either opaque or transparent. Opaque transfers, move the data specified to the destination. Transparent transfers, compare destination color to source color and write according to the mode of transparency selected.

Data is horizontally and vertically aligned at the destination. If the destination for the BLT overlaps with the source memory location, the GMCH can specify which area in memory to begin the BLT transfer. Use of this BLT engine accelerates the Graphical User Interface (GUI) of Microsoft* Windows. Hardware is included for all 256 raster operations (Source, Pattern, and Destination) defined by Microsoft* , including transparent BLT.

4.8.7.2. Arithmetic Stretch BLT Engine

The stretch BLT function can stretch source data in the X and Y directions to a destination larger or smaller than the source. Stretch BLT functionality expands a region of memory into a larger or smaller region using replication and interpolation.

The stretch BLT engine also provides format conversion and data alignment. Through an algorithm implemented in the mapping engine, object expansion and contraction can occur in the horizontal and vertical directions.

4.8.8. Hardware Motion Compensation

The Motion Compensation (MC) process consists of reconstructing a new picture by predicting (either forward, backward or bidirectionally) the resulting pixel colors from one or more reference pictures. The GMCH intercepts the DVD pipeline at Motion Compensation and implements Motion Compensation and subsequent steps in hardware. Performing Motion Compensation in hardware reduces the processor demand of software-based MPEG-2 decoding and, thus, improves system performance.

The GMCH's implementation of Hardware Motion Compensation supports a motion smoothing algorithm. When the system processor is not able to process the MPEG decoding stream in a timely manner (as can happen in software DVD implementations), the GMCH supports downsampled MPEG decoding. Downsampling allows for reduced spatial resolution in the MPEG picture while maintaining a full frame rate; this reduces processor load while maintaining the best video quality possible given the processor constraints.

4.8.9. Hardware Cursor

The GMCH allows an unlimited number of cursor patterns to be stored in the display cache or system memory. Two sets of registers contain the x and y position of the cursor relative to the upper left corner of the display. The following four cursor modes are provided:

- 32x32 2 bpp AND/XOR 2-plane mode
- 64x64 2 bpp 3-color and transparency mode
- 64x64 2 bpp AND/XOR 2-plane mode
- 64x64 2 bpp 4-color mode

4.8.10. Overlay Engine

The overlay engine provides a method of merging either video capture data (from an external PCI Video Capture Adapter) or data delivered by the processor, with the graphics data on the screen. Supported data formats include YUV 4:2:2, YUV 4:2:0, YUV 4:1:0, YUV 4:1:1, RGB15, and RGB16. The source data can be mirrored horizontally or vertically or both. Overlay data comes from a buffer located in system memory. Additionally, the overlay engine can be quadruple buffered to support flipping between different overlay images. Data can either be transferred into the overlay buffer from the host or from an external PCI adapter (e.g., DVD hardware or video capture hardware). Buffer swaps can be done by the host and internally synchronized with the display VBLANK.

The GMCH can accept line widths up to 720 pixels. In addition, overlay source and destination chromakeying are also supported. Overlay source/destination chromakeying enables blending of the overlay with the underlying graphics background. Destination color/chroma keying can be used to handle occluded portions of the overlay window on a pixel-by-pixel basis which is actually an underlay. Source color/chroma keying is used to handle transparency based on the overlay window on a pixel-by-pixel basis. This is used when “blue screening” an image in order to overlay the image on a new background later.

To compensate for overlay color intensity loss due to the non-linear response between display devices, the overlay engine supports independent gamma correction. In addition, the brightness, saturation, and contrast of the overlay may be independently varied.

4.8.11. Display

The display function contains a RAM-based Digital-to-Analog Converter (RAMDAC) that transforms the digital data from the graphics and video subsystems to analog data for the monitor. The GMCH's integrated 230 MHz RAMDAC provides resolution support up to 1600x1200. Circuitry is incorporated to limit the switching noise generated by the DACs. Three 8-bit DACs provide the R, G, and B signals to the monitor. Sync signals are properly delayed to match any delays from the D-to-A conversion. Associated with each DAC is a 256 pallet of colors. The RAMDAC can be operated in either direct or indexed color mode. In Direct color mode, pixel depths of 15, 16, or 24 bits can be realized. Non-interlaced mode is supported. Gamma correction can be applied to the display output.

The GMCH supports a wide range of resolutions, color depths, and refresh rates via a programmable dot clock that has a maximum frequency of 230 MHz.

Table 19. Partial List of Display Modes Supported

Resolution	Bits Per Pixel (frequency in Hz)		
	8-bit Indexed	16-bit	24-bit
320x200	70	70	70
320x240	70	70	70
352x480	70	70	70
352x576	70	70	70
400x300	70	70	70
512x384	70	70	70
640x400	70	70	70
640x480	60,70,72,75,85	60,70,72,75,85	60,70,72,75,85
720x480	75,85	75,85	75,85
720x576	60,75,85	60,75,85	60,75,85
800x600	60,70,72,75,85	60,70,72,75,85	60,70,72,75,85
1024x768	60, 70,72,75,85	60, 70,72,75,85	60, 70,72,75,85
1152x864	60,70,72,75,85	60,70,72,75,85	60,70,72,75,85
1280x720	60,75,85	60,75,85	60,75,85
1280x960	60,75,85	60,75,85	60,75,85
1280x1024	60,70,72,75,85	60,70,72,75,85	60,70,75,85
1600x900	60,75,85	60,75,85	
1600x1200	60,70,72,75		

4.8.12. Flat Panel/Digital CRT Interface / 1.8V TV-Out Interface

The GMCH has a dedicated port for Flat Panel support. This port is a 16 bit digital port (4 control bits and 12 data bits) with a 1.8V interface for high speed signaling. The port is designed to connect to transmission devices. The port can also be used to interface with an external TV encoder that requires 1.8V signals.

Connecting the GMCH to a flat panel transmitter is demonstrated below. For more details, refer to The *Intel® 815 Chipset Design Guide* or the *Intel® 815E Chipset Design Guide*.

The GMCH supports a variety of Flat Panel display modes and refresh rates that require up to a 65 MHz dot clock over this interface. Table 20 shows some of the display modes supported by the GMCH.

The GMCH supports scaling for all of the resolutions listed in Table 20. Actual scaling results are dependant on the third party flat panel transmitter. If the flat panel transmitter does not support scaling, the resolutions are supported by the GMCH via centering.

Table 21 shows some of the TV-Out modes supported by the GMCH.

Table 20. Partial List of Flat Panel Modes Supported

Resolution	Bits Per Pixel (frequency in Hz)		
	8-bit Indexed	16-bit	24-bit
320x200	60	60	60
320x240	60	60	60
352x480	60	60	60
352x480	60	60	60
352x576	60	60	60
400x300	60	60	60
512x384	60	60	60
640x350	60	60	60
640x400	60	60	60
640x480	60	60	60
720x480	60	60	60
720x576	60	60	60
800x600	60	60	60
1024x768	60	60	60

Table 21. Partial List of TV-Out Modes Supported

Resolution	Colors	NTSC	PAL
320x200 ¹	256	Yes	Yes
	16M	Yes	Yes
	64k	Yes	Yes
320x240	256	Yes	Yes
	16M	Yes	Yes
	64k	Yes	Yes
352x480 ¹	256	Yes	Yes
	16M	Yes	Yes
	64k	Yes	Yes
352x576 ¹	256	Yes	Yes
	16M	Yes	Yes
	64k	Yes	Yes
400x300 ¹	256	Yes	Yes
	16M	Yes	Yes
	64k	Yes	Yes
640x400 ¹	256	Yes	Yes
640x480	256	Yes	Yes
	64k	Yes	Yes
	16M	Yes	Yes
720x480 ¹	256	Yes	Yes
	64k	Yes	Yes
	16M	Yes	Yes
720x576 ¹	256	Yes	Yes
	64k	Yes	Yes
	16M	Yes	Yes
800x600	16	Yes	Yes
	256	Yes	Yes
	32k	Yes	Yes
	64k	Yes	Yes
	16M	Yes	Yes

NOTES:

1. These resolutions are supported via centering.

4.8.13. DDC (Display Data Channel)

DDC is a standard defined by VESA. Its purpose is to allow communication between the host system and display. Both configuration and control information can be exchanged allowing plug-and-play systems to be realized. Support for DDC 2B is implemented.

4.9. System Reset for the GMCH

Refer to the *Intel® 815 Chipset Design Guide* or *Intel® 815E Chipset Design Guide* (Power Sequencing section) for details.

4.10. System Clock Description

The Intel® 815 chipset family is supported by the CK815 chipset 2DIMM and CK815 chipset 3DIMM clock synthesizers. For details, refer to the *Intel® 815 Chipset Design Guide* or *Intel® 815E Chipset Design Guide*.

4.11. Power Management

4.11.1. Specifications Supported

The platform is compliant with the following specifications:

- APM Rev 1.2
- ACPI Rev 1.0
- PCI Power Management Rev 1.0
- PC 99 System Design Guide, Rev 1.0

5. Pinout and Package Information

5.1. 82815 GMCH Pinout

Figure 10 and Figure 11 show the ball foot print of the GMCH. These figures represent the ballout by ball number. Table 22 provides an alphabetical signal listing of the ballout.



Figure 10. GMCH Pinout (Top View-Left Side)

	1	2	3	4	5	6	7	8	9	10	11	12	13
A	SMD17	SMD49	SMD16	SMD48	SDQM7	SDQM3	SDQM2	SCSB5#	SMAC7#	SMAC5#	SMAA7	SMAA5	SMAA11
B	SMD50	VSUS3.3	SMD56	SMD23	VSUS3.3	SDQM6	SMAA12	VSUS3.3	SCSB4#	SMAC4#	VSUS3.3	SMAA4	SBS0
C	SMD18	SMD25	VSS	SMD55	SMD22	VSS	SCKE5	SCKE4	VSS	SMAC6#	SMAA6	VSS	SMAA9
D	VSS	SMD57	SMD26	SMD24	SMD54	SMD21	SCKE3	SCKE0	SCSB3#	SCSB2#	SBS1	SMAA8	SMAA0
E	SMD51	VSUS3.3	SMD58	SMD27	VSS	SMD53	VSS	SCKE1	SCKE2	VSS	SMAA10	VSS	SCSA4#
F	VSS	SMD19	VSS	SMD59	SMD28	SMD60	SCLK	SCSB1#	SCSB0#	VSUS3.3	VSS	SMAA2	VSS
G	ADS#	SMD52	SMD20	SMD29	SMD61	VSUS3.3	SRCOMP	VSUS3.3	VSS	NC			
H	RS2#	VSUS3.3	RESET#	SMD62	VSUS3.3	VSS	VSUS3.3						
J	DRDY#	VSS	DBSY#	SMD63	VSS	SMD30	VCCDPLL						
K	HIT#	RS0#	HTRDY#	VSS	SMD31	V1.8	VSSDPLL						
L	RS1#	VSS	HITM#	HLOCK#	HREQ3#	VSS					VSS	VSS	VSS
M	HREQ0#	HREQ2#	DEFER#	VSS	BPRI#	V1.8					VSS	VSS	VSS
N	HREQ1#	VSS	HREQ4#	BNR#	HA7#	VSS					VSS	VSS	VSS
P	HA4#	HA11#	HA14#	VSS	HA8#	V1.8					VSS	VSS	VSS
R	HA9#	VSS	HA6#	HA3#	HA16#	VSS					VSS	VSS	VSS
T	HA12#	HA5#	HA13#	VSS	HA15#	V1.8					VSS	VSS	VSS
U	HA10#	VSS	HA28#	HA21#	HA25#	GTLREF0	VSS						
V	HA31#	HA22#	HA19#	VSS	HA17#	VSS	V1.8						
W	HA20#	VSS	HA23#	HA24#	HA30#	V1.8	VSS						
Y	HA29#	HA18#	HA27#	VSS	HA26#	VSS	V1.8	VSS	V1.8	VSS			
AA	HD0#	VSS	HD6#	HD15#	CPURST#	V1.8	HCLK	V1.8	VSS	GTLREF1	V1.8	VSS	V1.8
AB	HD4#	HD1#	HD5#	VSS	HD23#	HD19#	HD31#	HD34#	HD37#	HD42#	HD41#	HD48#	HD55#
AC	HD8#	VSS	HD17#	HD7#	VSS	HD25#	VSS	HD22#	VSS	HD44#	VSS	HD63#	VSS
AD	HD10#	HD12#	HD13#	HD3#	HD30#	HD16#	HD33#	HD29#	HD43#	HD39#	HD27#	HD47#	HD59#
AE	HD18#	VSS	HD11#	VSS	HD21#	VSS	HD35#	VSS	HD36#	VSS	HD49#	VSS	HD57#
AF	HD14#	HD2#	HD9#	HD20#	HD24#	HD26#	HD32#	HD28#	HD38#	HD45#	HD51#	HD40#	HD52#

Figure 11. GMCH Pinout (Top View-Right Side)

14	15	16	17	18	19	20	21	22	23	24	25	26	
SMAB7#	SMAB5#	SMAA3	SCSA1#	SDQM4	SMD47	SMD45	SMD42	SMD39	SMD37	SMD35	SMD33	SMD32	A
VSUS3.3	SMAB4#	SMAA1	SCSA5#	SMD12	VSUS3.3	SMD44	SMD41	VSUS3.3	SMD36	SMD34	VSUS3.3	VSS	B
SMAB6#	VSS	SRAS#	SDQM5	VSS	SMD46	SMD43	VSS	SMD38	SMD1	VSS	V1.8	HL10	C
SCSA2#	SCSA0#	SDQM0	SMD15	SCAS#	SMD10	SMD7	SMD40	SMD2	SMD0	HL9	HL8	HL7	D
SCSA3#	VSS	SWE#	VSS	SMD11	SMD9	VSS	SMD4	VSSBA	VCCBA	V1.8	HL6	HL5	E
VSUS3.3	SDQM1	VSS	VSUS3.3	SMD13	SMD8	SMD6	SMD3	HLCLK	V1.8	HL4	VSS	HLPSTRB#	F
			VSS	SMD14	VSUS3.3	SMD5	VSS	V1.8	VSS	HL3	HLPSTRB	V1.8	G
						HLZCOMP	HLREF	VSS	G_C/BE0#	HL0	HL2	HL1	H
						G_AD5	G_AD3	G_AD1	VSS	AGPREF	VSS	GRCOMP	J
						VDDQ	VSS	G_AD8	G_AD7	VSS	G_AD2	G_AD0	K
VSS	VSS	VSS					VDDQ	VSS	AD_STB0#	G_AD4	VSS	G_AD6	L
VSS	VSS	VSS					G_AD12	AD_STB0	VDDQ	G_AD10	G_AD9	G_AD11	M
VSS	VSS	VSS					G_C/BE1#	G_AD14	VSS	G_AD13	VDDQ	G_AD15	N
VSS	VSS	VSS					G_TRDY#	LRCLK	G_IRDY#	VSS	G_STOP#	G_DEVSEL#	P
VSS	VSS	VSS					VDDQ	LOCLK	VSS	G_PAR	VSS	G_FRAME#	R
VSS	VSS	VSS					VSS	G_AD17	G_AD19	G_AD21	G_C/BE2#	G_AD16	T
						VDDQ	G_AD23	AD_STB1	VDDQ	G_AD18	VDDQ	G_AD20	U
						VSS	G_AD25	VSS	AD_STB1#	G_AD22	G_AD24	G_AD26	V
						VDDQ	G_AD27	G_AD29	VSS	G_AD28	VSS	G_AD30	W
			VSS	V1.8	VSSDA	IWASTE	G_AD31	SBA6	SB_STB	VDDQ	SBA7	G_C/BE3#	Y
VSS	V1.8	VSS	V1.8	DDDA	V1.8	LTVDA	VCCDA	SBA4	VSS	SB_STB#	VSS	SBA5	AA
HD53#	HD56#	V1.8	LTVHSYNC	DDCK	LTVBLANK#	V1.8	LTVCK	SBA0	SBA2	WBF#	SBA1	SBA3	AB
HD58#	VSS	LTVVSYNC	VSS	LTVCLKIN	VSS	LTVDATA8	VSS	V1.8	ST2	ST1	VSS	PIPE#	AC
HD46#	HD60#	LTVDATA0	LTVDATA3	LTVDATA5	V1.8	LTVDATA7	LTVDATA11	RED	IREF	ST0	G_GNT#	RBF#	AD
VSS	HD50#	VSS	LTVDATA2	VSS	LTVCLKOUT0	VSS	LTVDATA10	GREEN	BLUE	DCLKREF	VSSDACA	G_REQ#	AE
HD54#	HD62#	HD61#	LTVDATA1	LTVDATA4	LTVCLKOUT1	LTVDATA6	LTVDATA9	VSUS3.3	HSUS3.3	VSSDACA	VCCDACA2	VCCDACA1	AF

Table 22. Alphabetical Pin Assignment

Signal Name	Ball #
ADS#	G1
AD_STB0	M22
AD_STB0#	L23
AD_STB1	U22
AD_STB1#	V23
AGPREF	J24
BLUE	AE23
BNR#	N4
BPRI#	M5
CPURST#	AA5
DBSY#	J3
DCLKREF	AE24
DDCK	AB18
DDDA	AA18
DEFER#	M3
DRDY#	J1
G_AD0	K26
G_AD1	J22
G_AD2	K25
G_AD4	L24
G_AD5	J20
G_AD6	L26
G_AD7	K23
G_AD8	K22
G_AD9	M25
G_AD10	M24
G_AD11	M26
G_AD12	M21
G_AD13	N24
G_AD14	N22
G_AD15	N26
G_AD16	T26
G_AD17	T22
G_AD18	U24
G_AD19	T23

Signal Name	Ball #
G_AD20	U26
G_AD21	T24
G_AD22	V24
G_AD23	U21
G_AD24	V25
G_AD25	V21
G_AD26	V26
G_AD27	W21
G_AD28	W24
G_AD29	W22
G_AD3	J21
G_AD30	W26
G_AD31	Y21
G_C/BE0#	H23
G_C/BE1#	N21
G_C/BE2#	T25
G_C/BE3#	Y26
G_DEVSEL#	P26
G_FRAME#	R26
G_GNT#	AD25
G_IRDY#	P23
G_PAR	R24
GRCOMP	J26
GREEN	AE22
G_REQ#	AE26
G_STOP#	P25
GTLREF0	U6
GTLREF1	AA10
G_TRDY#	P21
HA3#	R4
HA4#	P1
HA5#	T2
HA6#	R3
HA7#	N5
HA8#	P5
HA9#	R1

Signal Name	Ball #
HA10#	U1
HA11#	P2
HA12#	T1
HA13#	T3
HA14#	P3
HA15#	T5
HA16#	R5
HA17#	V5
HA18#	Y2
HA19#	V3
HA20#	W1
HA21#	U4
HA22#	V2
HA23#	W3
HA24#	W4
HA25#	U5
HA26#	Y5
HA27#	Y3
HA28#	U3
HA29#	Y1
HA30#	W5
HA31#	V1
HCLK	AA7
HD0#	AA1
HD1#	AB2
HD2#	AF2
HD3#	AD4
HD4#	AB1
HD5#	AB3
HD6#	AA3
HD7#	AC4
HD8#	AC1
HD9#	AF3
HD10#	AD1
HD11#	AE3
HD12#	AD2

Signal Name	Ball #
HD13#	AD3
HD14#	AF1
HD15#	AA4
HD16#	AD6
HD17#	AC3
HD18#	AE1
HD19#	AB6
HD20#	AF4
HD21#	AE5
HD22#	AC8
HD23#	AB5
HD24#	AF5
HD25#	AC6
HD26#	AF6
HD27#	AD11
HD28#	AF8
HD29#	AD8
HD30#	AD5
HD31#	AB7
HD32#	AF7
HD33#	AD7
HD34#	AB8
HD35#	AE7
HD36#	AE9
HD37#	AB9
HD38#	AF9
HD39#	AD10
HD40#	AF12
HD41#	AB11
HD42#	AB10
HD43#	AD9
HD44#	AC10
HD45#	AF10
HD46#	AD14
HD47#	AD12
HD48#	AB12

Signal Name	Ball #
HD49#	AE11
HD50#	AE15
HD51#	AF11
HD52#	AF13
HD53#	AB14
HD54#	AF14
HD55#	AB13
HD56#	AB15
HD57#	AE13
HD58#	AC14
HD59#	AD13
HD60#	AD15
HD61#	AF16
HD62#	AF15
HD63#	AC12
HIT#	K1
HITM#	L3
HL0	H24
HL1	H26
HL2	H25
HL3	G24
HL4	F24
HL5	E26
HL6	E25
HL7	D26
HL8	D25
HL9	D24
HL10	C26
HLCLK	F22
HLOCK#	L4
HLPSTRB	G25
HLPSTRB#	F26
HLREF	H21
HLZCOMP	H20
HREQ0#	M1
HREQ1#	N1
HREQ2#	M2

Signal Name	Ball #
HREQ3#	L5
HREQ4#	N3
HSYNC	AF23
HTRDY#	K3
IREF	AD23
IWASTE	Y20
LOCLK	R22
LRCLK	P22
LTVBLANK#	AB19
LTVCK	AB21
LTVCKLIN	AC18
LTVCLKOUT0	AE19
LTVCLKOUT1	AF19
LTVDA	AA20
LTVDATA0	AD16
LTVDATA1	AF17
LTVDATA10	AE21
LTVDATA11	AD21
LTVDATA2	AE17
LTVDATA3	AD17
LTVDATA4	AF18
LTVDATA5	AD18
LTVDATA6	AF20
LTVDATA7	AD20
LTVDATA8	AC20
LTVDATA9	AF21
LTVHSYNC	AB17
LTVVSYNC	AC16
NC	G10
PIPE#	AC26
RBF#	AD26
RED	AD22
RESET#	H3
RS0#	K2
RS1#	L1
RS2#	H1
SBA0	AB22

Signal Name	Ball #
SBA1	AB25
SBA2	AB23
SBA3	AB26
SBA4	AA22
SBA5	AA26
SBA6	Y22
SBA7	Y25
SBS0	B13
SBS1	D11
SB_STB	Y23
SB_STB#	AA24
SCAS#	D18
SCKE0	D8
SCKE1	E8
SCKE2	E9
SCKE3	D7
SCKE4	C8
SCKE5	C7
SCLK	F7
SCSA0#	D15
SCSA1#	A17
SCSA2#	D14
SCSA3#	E14
SCSA4#	E13
SCSA5#	B17
SCSB0#	F9
SCSB1#	F8
SCSB2#	D10
SCSB3#	D9
SCSB4#	B9
SCSB5#	A8
SDQM0	D16
SDQM1	F15
SDQM2	A7
SDQM3	A6
SDQM4	A18
SDQM5	C17

Signal Name	Ball #
SDQM6	B6
SDQM7	A5
SMAA0	D13
SMAA1	B16
SMAA10	E11
SMAA11	A13
SMAA12	B7
SMAA2	F12
SMAA3	A16
SMAA4	B12
SMAA5	A12
SMAA6	C11
SMAA7	A11
SMAA8	D12
SMAA9	C13
SMAB4#	B15
SMAB5#	A15
SMAB6#	C14
SMAB7#	A14
SMAC4#	B10
SMAC5#	A10
SMAC6#	C10
SMAC7#	A9
SMD0	D23
SMD1	C23
SMD2	D22
SMD3	F21
SMD4	E21
SMD5	G20
SMD6	F20
SMD7	D20
SMD8	F19
SMD9	E19
SMD10	D19
SMD11	E18
SMD12	B18
SMD13	F18

Signal Name	Ball #
SMD14	G18
SMD15	D17
SMD16	A3
SMD17	A1
SMD18	C1
SMD19	F2
SMD20	G3
SMD21	D6
SMD22	C5
SMD23	B4
SMD24	D4
SMD25	C2
SMD26	D3
SMD27	E4
SMD28	F5
SMD29	G4
SMD30	J6
SMD31	K5
SMD32	A26
SMD33	A25
SMD34	B24
SMD35	A24
SMD36	B23
SMD37	A23
SMD38	C22
SMD39	A22
SMD40	D21
SMD41	B21
SMD42	A21
SMD43	C20
SMD44	B20
SMD45	A20
SMD46	C19
SMD47	A19
SMD48	A4
SMD49	A2
SMD50	B1

Signal Name	Ball #
SMD51	E1
SMD52	G2
SMD53	E6
SMD54	D5
SMD55	C4
SMD56	B3
SMD57	D2
SMD58	E3
SMD59	F4
SMD60	F6
SMD61	G5
SMD62	H4
SMD63	J4
SRAS#	C16
SRCOMP	G7
ST0	AD24
ST1	AC24
ST2	AC23
SWE#	E16
V1.8	C25
V1.8	T6
V1.8	V7
V1.8	W6
V1.8	AA6
V1.8	Y9
V1.8	Y18
V1.8	AA8
V1.8	AA11
V1.8	AA13
V1.8	AA15
V1.8	E24
V1.8	AA17
V1.8	AA19
V1.8	AD19
V1.8	AC22
V1.8	AB16
V1.8	AB20

Signal Name	Ball #
V1.8	F23
V1.8	G22
V1.8	G26
V1.8	K6
V1.8	M6
V1.8	P6
V1.8	Y7
VCCBA	E23
VCCDA	AA21
VCCDACA1	AF26
VCCDACA2	AF25
VCCDLL	J7
VDDQ	N25
VDDQ	K20
VDDQ	L21
VDDQ	M23
VDDQ	U25
VDDQ	R21
VDDQ	U23
VDDQ	W20
VDDQ	Y24
VDDQ	U20
VSS	F1
VSS	AA12
VSS	AC11
VSS	P14
VSS	P15
VSS	P16
VSS	P4
VSS	R11
VSS	R12
VSS	R13
VSS	R14
VSS	R15
VSS	R16
VSS	AC13
VSS	R2

Signal Name	Ball #
VSS	R23
VSS	R25
VSS	R6
VSS	T11
VSS	T12
VSS	T13
VSS	T14
VSS	T15
VSS	T16
VSS	AC15
VSS	T21
VSS	T4
VSS	U2
VSS	K24
VSS	U7
VSS	V22
VSS	V4
VSS	V6
VSS	W2
VSS	AC17
VSS	V20
VSS	W23
VSS	W25
VSS	W7
VSS	Y10
VSS	Y17
VSS	P13
VSS	Y4
VSS	Y8
VSS	AC19
VSS	AC2
VSS	AC21
VSS	AC25
VSS	AC5
VSS	AC7
VSS	AA14
VSS	AC9

Signal Name	Ball #
VSS	AE10
VSS	AE12
VSS	AE14
VSS	AE16
VSS	AE18
VSS	AE2
VSS	AE20
VSS	AE4
VSS	AE6
VSS	AA16
VSS	AE8
VSS	B26
VSS	C12
VSS	C15
VSS	C18
VSS	C21
VSS	C24
VSS	C3
VSS	C6
VSS	C9
VSS	AA2
VSS	D1
VSS	E10
VSS	E12
VSS	E15
VSS	E17
VSS	E20

Signal Name	Ball #
VSS	E5
VSS	E7
VSS	F11
VSS	AA25
VSS	F13
VSS	F16
VSS	F25
VSS	F3
VSS	G17
VSS	G21
VSS	G23
VSS	G9
VSS	Y6
VSS	H22
VSS	H6
VSS	J2
VSS	J23
VSS	J25
VSS	J5
VSS	K4
VSS	L11
VSS	AA9
VSS	L12
VSS	L13
VSS	L14
VSS	L15
VSS	L16

Signal Name	Ball #
VSS	L2
VSS	L22
VSS	L25
VSS	L6
VSS	M11
VSS	AA23
VSS	M12
VSS	M13
VSS	M14
VSS	M15
VSS	M16
VSS	K21
VSS	M4
VSS	N11
VSS	N12
VSS	N13
VSS	AB4
VSS	N14
VSS	N15
VSS	N16
VSS	N2
VSS	N23
VSS	P24
VSS	N6
VSS	P11
VSS	P12
VSSBA	E22

Signal Name	Ball #
VSSDA	Y19
VSSDACA	AE25
VSSDACA	AF24
VSSDPLL	K7
VSUS3.3	F14
VSUS3.3	B2
VSUS3.3	F10
VSUS3.3	F17
VSUS3.3	G6
VSUS3.3	G8
VSUS3.3	H2
VSUS3.3	H5
VSUS3.3	H7
VSUS3.3	G19
VSUS3.3	B5
VSUS3.3	B8
VSUS3.3	B11
VSUS3.3	B14
VSUS3.3	B19
VSUS3.3	B22
VSUS3.3	B25
VSUS3.3	E2
VSYNC	AF22
WBF#	AB24

5.2. Package Information

This specification outlines the mechanical dimensions for the GMCH. The package is a 544 ball grid array (BGA).

Figure 12. GMCH BGA Package Dimensions (Top and Side Views)

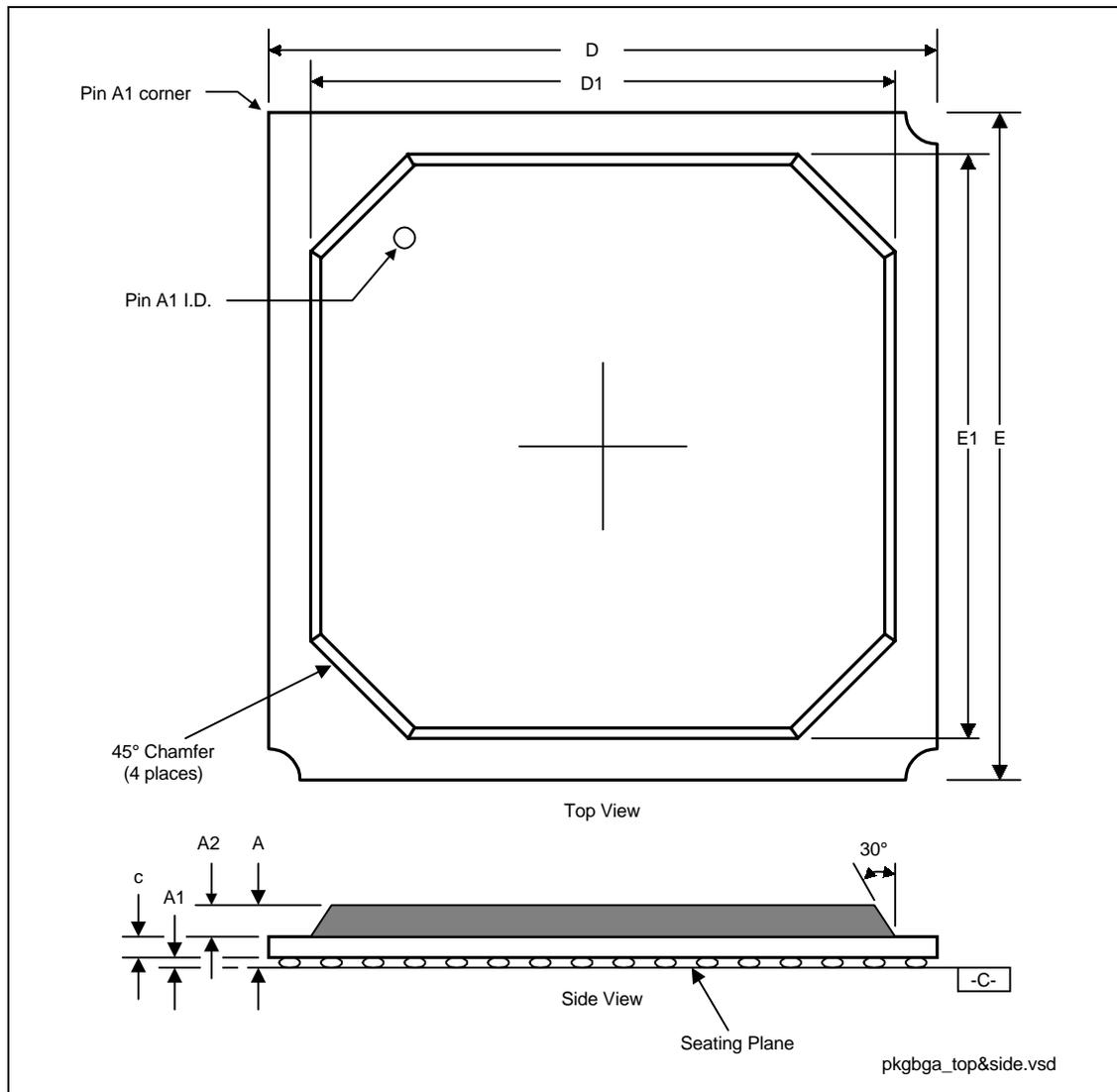
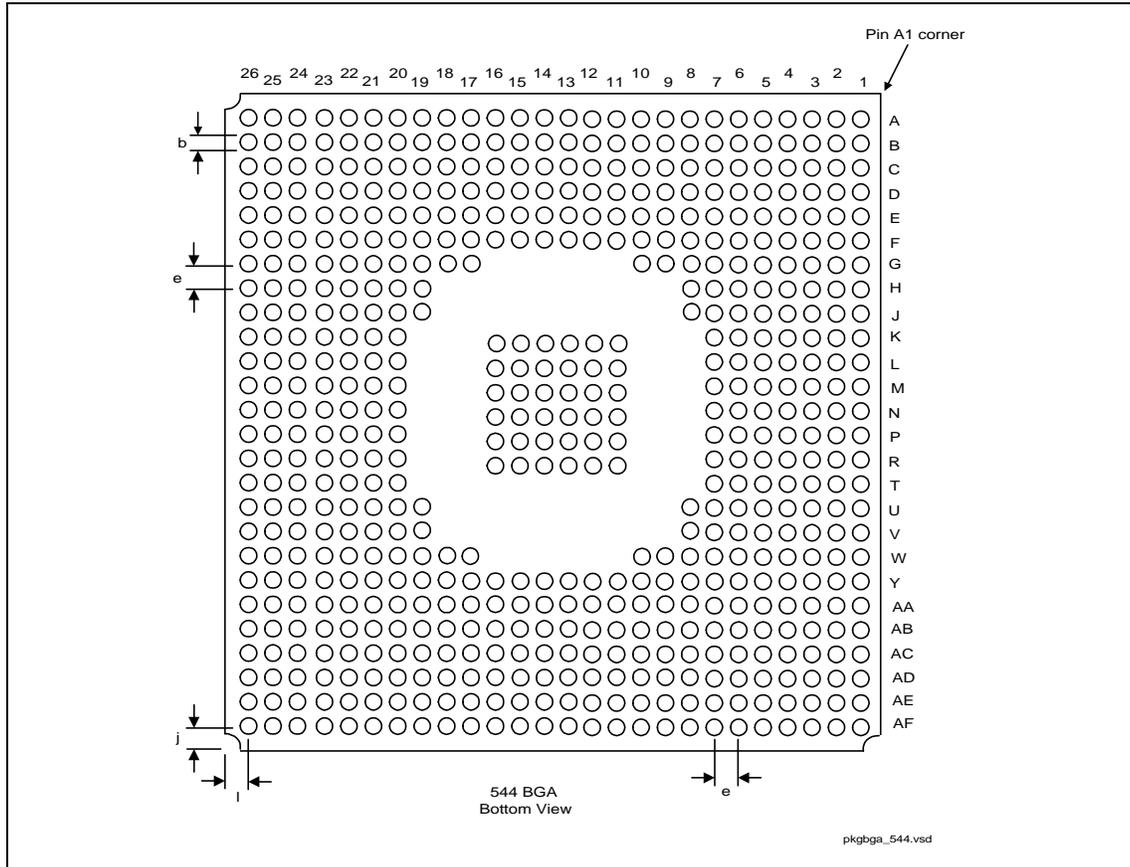

Figure 13. GMCH BGA Package Dimensions (Bottom View)

Table 23. Package Dimensions

Symbol	Min	Nominal	Max	Units	Note
A	2.17	2.38	2.59	mm	
A1	0.50	0.60	0.70	mm	
A2	1.12	1.17	1.22	mm	
D	34.80	35.00	35.20	mm	
D1	29.75	30.00	30.25	mm	
E	34.80	35.00	35.20	mm	
E1	29.75	30.00	30.25	mm	
e	1.27 (solder ball pitch)			mm	
l	1.63 REF.			mm	
J	1.63 REF.			mm	
M	26 x 26 Matrix			mm	
b ²	0.60	0.75	0.90	mm	
c	0.55	0.61	0.67	mm	

NOTES:

1. All dimensions and tolerances conform to ANSI Y14.5-1982
2. Dimension is measured at maximum solder ball diameter parallel to primary datum (-C-)
3. Primary Datum (-C-) and seating plane are defined by the spherical crowns of the solder balls.



This page is intentionally left blank.

6. Testability

In the GMCH, the testability for Automated Test Equipment (ATE) board level testing has been changed from the traditional NAND chain mode to a XOR chain. The GMCH pins are grouped in eight XOR chains.

An XOR-Tree is a chain of XOR gates each with one of its inputs connected to a GMCH input pin or bi-directional pin (used as an input pin only). The other input of each XOR gate connects to the non-inverted output of the previous XOR gate in the chain. The first XOR gate of each chain will have one pin internally connected tied to Vcc. The output of the last XOR gate is the chain output. Figure 14 shows the GMCH XOR chain implementation.

Figure 14. XOR Tree Implementation

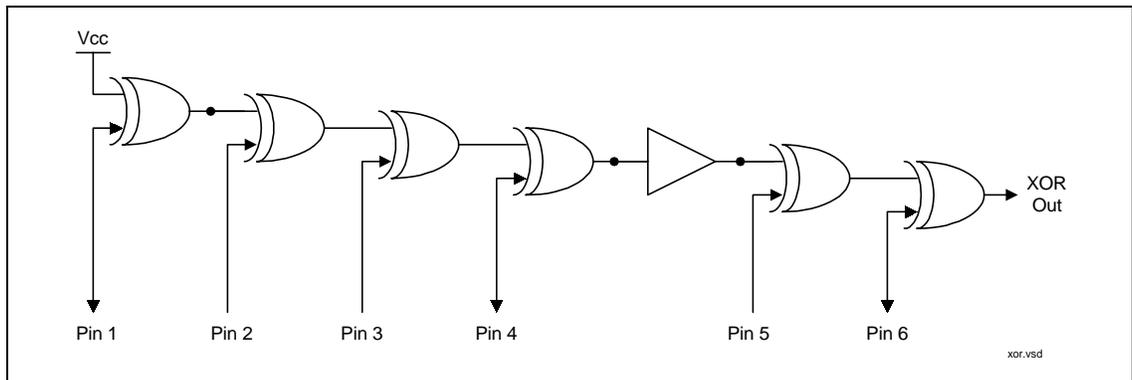

6.1. XOR Tree Testability Algorithm Example

XOR tree testing allows users to check, for example, opens and shorts to VCC or GND. An example algorithm to do this is shown in Table 24.

Table 24. XOR Test Pattern Example

Pin # from Figure 14							
Vector	PIN1	PIN2	PIN3	PIN4	PIN5	PIN6	XOROut
1	0	0	0	0	0	0	1
2	1	0	0	0	0	0	0
3	1	1	0	0	0	0	1
4	1	1	1	0	0	0	0
5	1	1	1	1	0	0	1
6	1	1	1	1	1	0	0
7	1	1	1	1	1	1	1

In this example, Vector 1 applies all 0s to the chain inputs. The outputs being non-inverting, will consistently produce a 1 at the XOR chain output on a good board. One short to Vcc (or open floating to Vcc) will cause a 0 at the chain output, signaling a defect.

Likewise, applying Vector 7 (all 1s) to chain inputs (given that there are an even number of signals in the chain), will consistently produce a 1 at the XOR chain output on a good board. One short to Vss (or open floating to Vss) will cause a 0 at the chain output, signaling a defect. It is important to note that the number of inputs pulled to 1 will affect the expected chain output value. If the number chain inputs pulled to 1 is even, then expect 1 at XOR-out; otherwise, if odd, expect 0.

Continuing to Illustrate with the example pattern in Table 24, as the pins are driven to 1 across the chain in sequence, XOR-out will toggle between 0 and 1. Any break in the toggling sequence (e.g., 1011) will identify the location of the short or open.

6.1.1. Test Pattern Consideration for XOR Chains 3 and 4, and 7 and 8

Bi-directional pins HLPSTRB (chain 3) and HLPSTRB# (chain 4), and AGP strobes AD_STB0, AD_STB1, and SB_STB (chain 7) and AD_STB0#, AD_STB1#, and SB_STB# (chain 8) must always be complementary to each other. For example, if a 1 is driven on to HLPSTRB, a 0 must be driven on HLPSTRB# and vice versa. This will need to be considered in applying test patterns to these chains.

6.2. XOR Tree Initialization

6.2.1. Chain [1:6] Initialization

On chains [1:6], all that is required to prepare the device for XOR chain testing is to pull SRAS# low prior to deasserting RESET#. The following sequence will put the GMCH into XOR testability mode:

1. Deassert RESET# high and assert SRAS# low
2. Assert RESET# low; maintain SRAS# low
3. Deassert RESET# high; maintain SRAS# low
4. RESET# must be maintained high for the duration of testing.

No external clocking of the GMCH is required for testing these chains.

6.2.2. Chain [7:8] Initialization

On chains[7:8], all that is required to prepare the device for XOR chain testing is to pull SMAA2 low prior to deasserting RESET#, then set LTVCK high and LTVDATA[11:6] to [101101] (1 means high and 0 means low), follow other LTVCK high and LTVDATA[11:6] to [100011]. The following sequence puts the GMCH into XOR testability mode for Chain[7:8] only:

1. Deassert RESET# high and assert SMAA2 low
2. Assert RESET# low; maintain SMAA2 low
3. Deassert RESET# high; maintain SMAA2 low
4. Deassert LTVCK low and assert LTVDATA[11:6] to [101101]
5. Assert LTVCK high; maintain LTVDATA[11:6] to [101101]
6. Deassert LTVCK low; maintain LTVDATA[11:6] to [101101]
7. Deassert LTVCK low and assert LTVDATA[11:6] to [100011]
8. Assert LTVCK high; maintain LTVDATA[11:6] to [100011]
9. Deassert LTVCK low; maintain LTVDATA[11:6] to [100011]
10. RESET# must be maintained high for the duration of testing

No external clocking of the GMCH is required for testing these chains.

6.3. XOR Chain

This is the primary test mode for checking the IO buffer connectivity. There are a total of 8 XOR chains each containing less than 65 XOR gates. The XOR gates are physically located in the IO buffers. This test mode can be invoked with the use of reset straps.

Table 25 XOR Chain 1 35 Inputs Output: SMAA5 (A12)

Pin Name	Ball	Voltage	Pin Name	Ball	Voltage	Pin Name	Ball	Voltage
DEFER#	M3	1.5V	HD12#	AD2	1.5V	HD30#	AD5	1.5V
HD0#	AA1	1.5V	HD18#	AE1	1.5V	HD9#	AF3	1.5V
HA30#	W5	1.5V	HD7#	AC4	1.5V	HD16#	AD6	1.5V
HD4#	AB1	1.5V	HD13#	AD3	1.5V	HD21#	AE5	1.5V
HD6#	AA3	1.5V	HD23#	AB5	1.5V	HD20#	AF4	1.5V
HA26#	AF6	1.5V	HD14#	AF1	1.5V	HD24#	AF5	1.5V
HD1#	AB2	1.5V	HD2#	AF2	1.5V	HD22#	AC8	1.5V
HD15#	AA4	1.5V	HD19#	AB6	1.5V	HD26#	AF6	1.5V
HD8#	AC1	1.5V	HD3#	AD4	1.5V	HD29#	AD8	1.5V
HD5#	AB3	1.5V	HD11#	AE3	1.5V	HD28#	AF8	1.5V
HD10#	AD1	1.5V	HD31#	AB7	1.5V	HD27#	AD11	1.5V
HD17#	AC3	1.5V	HD25#	AC6	1.5V			

Table 26 XOR Chain 2 33 Inputs Output: SMAA2 (F12)

Pin Name	Ball	Voltage	Pin Name	Ball	Voltage	Pin Name	Ball	Voltage
BPRI#	M5	1.5V	HD38#	AF9	1.5V	HD55#	AB13	1.5V
HD34#	AB8	1.5V	HD45#	AF10	1.5V	HD52#	AF13	1.5V
HD33#	AD7	1.5V	HD41#	AB11	1.5V	HD58#	AC14	1.5V
HD37#	AB9	1.5V	HD49#	AE11	1.5V	HD46#	AD14	1.5V
HD35#	AE7	1.5V	HD63#	AC12	1.5V	HD54#	AF14	1.5V
HD32#	AF7	1.5V	HD51#	AF11	1.5V	HD53#	AB14	1.5V
HD43#	AD9	1.5V	HD47#	AD12	1.5V	HD62#	AF15	1.5V
HD44#	AC10	1.5V	HD48#	AB12	1.5V	HD50#	AE15	1.5V
HD36#	AE9	1.5V	HD40#	AF12	1.5V	HD60#	AD15	1.5V
HD42#	AB10	1.5V	HD59#	AD13	1.5V	HD56#	AB15	1.5V
HD39#	AD10	1.5V	HD57#	AE13	1.5V	HD61#	AF16	1.5V

Table 27 XOR Chain 3 38 Inputs Output: SMAA0 (D13)

Pin Name	Ball	Voltage	Pin Name	Ball	Voltage	Pin Name	Ball	Voltage
HL1	H26	1.8V	HA7#	N5	1.5V	HA24#	W4	1.5V
HL0	H24	1.8V	HA14#	P3	1.5V	HA27#	Y3	1.5V
HLPSTRB	G25	1.8V	HA8#	P5	1.5V	CPURST#	AA5	1.5V
HL5	E26	1.8V	HA3#	R4	1.5V	LTVHSYNC	AB17	1.8V
HL6	E25	1.8V	HA9#	R1	1.5V	LTVCLKIN	AC18	1.8V
HL8	D25	1.8V	HA12#	T1	1.5V	LTVDATA6	AF20	1.8V
ADS#	G1	1.5V	HA13#	T3	1.5V	LTVDATA9	AF21	1.8V
HTRDY#	K3	1.5V	HA10#	U1	1.5V	LTVDATA7	AD20	1.8V
DRDY#	J1	1.5V	HA21#	AE5	1.5V	LTVBLANK#	AB19	1.8V
RS0#	K2	1.5V	HA22#	AC8	1.5V	LTVDATA10	AE21	1.8V
HIT#	K1	1.5V	HA19#	AB6	1.5V	LTVDATA8	AC20	1.8V
HREQ2#	M2	1.5V	HA23#	W3	1.5V	LTVDATA11	AD21	1.8V
HREQ0#	M1	1.5V	HA17#	V5	1.5V			

Table 28 XOR Chain 4 36 Inputs Output: SMAA9 (D13)

Pin Name	Ball	Voltage	Pin Name	Ball	Voltage	Pin Name	Ball	Voltage
HL2	H25	1.8V	HREQ4#	N3	1.5V	HA18#	Y2	1.5V
HL3	G24	1.8V	HREQ1#	N1	1.5V	LTVDATA0	AD16	1.8V
HLPSTRB#	F26	1.8V	HA11#	P2	1.5V	LTVVSYNC	AC16	1.8V
HL4	F24	1.8V	HA4#	P1	1.5V	LTVDATA1	AF17	1.8V
HL7	D26	1.8V	HA6#	R3	1.5V	LTVDATA2	AE17	1.8V
HL10	C26	1.8V	HA16#	AD6	1.5V	LTVDATA3	AD17	1.8V
DBSY#	J3	1.5V	HA5#	T2	1.5V	LTVDATA4	AF18	1.8V
RS2#	H1	1.5V	HA15#	T5	1.5V	LTVDATA5	AD18	1.8V
HLOCK#	L4	1.5V	HA28#	U3	1.5V	LTVCLKOUT1	AF19	1.8V
HREQ3#	L5	1.5V	HA31#	V1	1.5V	LTVCLKOUT0	AE19	1.8V
HITM#	L3	1.5V	HA25#	U5	1.5V	HA20#	W1	1.5V
RS1#	L1	1.5V	BNR#	N4	1.5V	HA29#	Y1	1.5V

Table 29 XOR Chain 5 56 Inputs Output: SMD31 (K5)

Pin Name	Ball	Voltage	Pin Name	Ball	Voltage	Pin Name	Ball	Voltage
SBS1	D11	3.3V	SCKE5	C7	3.3V	SMD59	F4	3.3V
SMAA10	E11	3.3V	SCKE3	D7	3.3V	SMD50	B1	3.3V
SMAC5#	A10	3.3V	SMD39	A22	3.3V	SMD58	E3	3.3V
SMAC4#	B10	3.3V	SDQM7	A5	3.3V	SMD57	D2	3.3V
SMAC6#	C10	3.3V	SMD53	E6	3.3V	SMD62	H4	3.3V
SMAC7#	A9	3.3V	SMD54	D5	3.3V	SMD63	J4	3.3V
SMAA12	B7	3.3V	SMD48	A4	3.3V	SMD51	E1	3.3V
SDQM6	B6	3.3V	SMD55	C4	3.3V	SMD52	G2	3.3V
SCKE4	C8	3.3V	SMD60	F6	3.3V	SCSA2#	D14	3.3V
SMAB4#	B15	3.3V	SMD56	B3	3.3V	SMAB6#	C14	3.3V
SMD36	B23	3.3V	SMD49	A2	3.3V	SMAB5#	A15	3.3V
SMD35	A24	3.3V	SMD61	G5	3.3V	SMAB7#	A14	3.3V
VSYNC	AF22	3.3V	SDQM5	C17	3.3V	SCSA4#	E13	3.3V
SMD32	A26	3.3V	SCSA5#	B17	3.3V	SMD37	A23	3.3V
SMD41	B21	3.3V	SDQM4	A18	3.3V	SMD34	B24	3.3V
SMD42	A21	3.3V	SMD46	C19	3.3V	SMD33	A25	3.3V
SCSA0#	D15	3.3V	SMD45	A20	3.3V	SMD40	D21	3.3V
SCSA1#	A17	3.3V	SMD47	A19	3.3V	SMD38	C22	3.3V
SCSA3#	E14	3.3V	SMD43	C20	3.3V			

Table 30 XOR Chain 6 60 Inputs Output: SMAA11 (A13)

Pin Name	Ball	Voltage	Pin Name	Ball	Voltage	Pin Name	Ball	Voltage
LOCLK	R22	3.3V	SMD11	E18	3.3V	SRAS#	C16	3.3V
LRCLK	P22	3.3V	SMD10	D19	3.3V	SMAA1	B16	3.3V
SMD3	F21	3.3V	SMD13	F18	3.3V	SMAA3	A16	3.3V
SMD0	D23	3.3V	SMD44	B20	3.3V	SBS0	B13	3.3V
SMD5	G20	3.3V	SCAS#	D18	3.3V	LTVCK	AB21	3.3V
SMD6	F20	3.3V	SMD15	D17	3.3V	LTVDA	AA20	3.3V
SMD4	E21	3.3V	SWE#	E16	3.3V	DDCK	AB18	3.3V
SMD2	D22	3.3V	SMD12	B18	3.3V	DDDA	AA18	3.3V
SMD1	C23	3.3V	SDQM1	F15	3.3V	HSYNC	AF23	3.3V
SMD8	F19	3.3V	SDQM0	D16	3.3V	SMD19	F2	3.3V
SMD9	E19	3.3V	SMD27	E4	3.3V	SMD30	J6	3.3V
SMD7	D20	3.3V	SMD25	C2	3.3V	SMD20	G3	3.3V
SMD14	G18	3.3V	SMD29	G4	3.3V	SCSB1#	F8	3.3V
SCSB4#	B9	3.3V	SMD24	D4	3.3V	SDQM2	A7	3.3V
SCSB3#	D9	3.3V	SMD28	F5	3.3V	SCKE0	D8	3.3V
SCSB5#	A8	3.3V	SMD26	D3	3.3V	SCKE1	E8	3.3V
SCKE2	E9	3.3V	SMD17	A1	3.3V	SDQM3	A6	3.3V
SMAA7	A11	3.3V	SMD18	C1	3.3V	SMD21	D6	3.3V
SMAA6	C11	3.3V	SMD23	B4	3.3V	SMD22	C5	3.3V
SCSB2#	D10	3.3V	SMD16	A3	3.3V	SCSB0#	F9	3.3V

Table 31 XOR Chain 7 33 Inputs Output: SMAA8 (D12)

Pin Name	Ball	Voltage	Pin Name	Ball	Voltage	Pin Name	Ball	Voltage
ST2	AC23	Vddq	GAD25	V21	Vddq	G_STOP#	P25	Vddq
ST0	AD24	Vddq	G_AD28	W24	Vddq	G_AD14	N22	Vddq
G_GNT#	AD25	Vddq	G_AD22	V24	Vddq	G_AD13	N24	Vddq
RBF#	AD26	Vddq	AD_STB1	U22	Vddq	G_AD11	M26	Vddq
PIPE#	AC26	Vddq	G_AD26	V26	Vddq	G_AD9	M25	Vddq
SBA4	AA22	Vddq	G_AD17	T22	Vddq	AD_STB0	M22	Vddq
SB_STB	Y23	Vddq	G_AD21	T24	Vddq	G_AD4	L24	Vddq
SBA3	AB26	Vddq	G_AD18	U24	Vddq	G_AD7	K23	Vddq
SBA5	AA26	Vddq	G_C/BE2#	T25	Vddq	G_AD1	J22	Vddq
G_C/BE3#	Y26	Vddq	G_PAR	R24	Vddq	G_AD3	J21	Vddq
G_AD27	W21	Vddq	G_TRDY#	P21	Vddq	G_C/BE0#	H23	Vddq

Table 32 XOR Chain 8 31 Inputs Output: SMAA4 (B12)

Pin Name	Ball	Voltage	Pin Name	Ball	Voltage	Pin Name	Ball	Voltage
ST1	AC24	Vddq	G_AD30	W26	Vddq	G_AD23	U21	Vddq
G_REQ#	AE26	Vddq	AD_STB1#	V23	Vddq	G_AD12	M21	Vddq
WBF#	AB24	Vddq	G_AD24	V25	Vddq	G_AD10	M24	Vddq
SBA0	AB22	Vddq	G_AD19	T23	Vddq	G_AD8	K22	Vddq
SBA2	AB23	Vddq	G_AD20	U26	Vddq	AD_STB0#	L23	Vddq
SBA6	Y22	Vddq	G_AD16	T26	Vddq	G_AD6	L26	Vddq
SB_STB#	AA24	Vddq	G_IRDY#	P23	Vddq	G_AD2	K25	Vddq
SBA1	AB25	Vddq	G_FRAME#	R26	Vddq	G_AD5	J20	Vddq
SBA7	Y25	Vddq	G_DEVSEL#	P26	Vddq	G_AD0	K26	Vddq
G_AD29	W22	Vddq	G_C/BE1#	N21	Vddq			
G_AD31	Y21	Vddq	G_AD15	N26	Vddq			

6.4. All Z

To apply vectors to XOR chains on a system board, other chips on the board must be tri-stated to allow for this vector application. This is a feature that enables all GMCH outputs to be tristated when the I/O Controller Hub is in the XOR chain mode. This mode can also be activate using the assigned reset strap.

Tri-state GMCH Outputs

When testing other devices in the system, the GMCH outputs can be tri-stated. To tri-state these outputs pull the SMAA10 pin low (GND) prior to deasserting RESET#. The following sequence will put the GMCH into tri-state mode:

1. 1. Deassert RESET# high and SMAA10 low
2. 2. Assert RESET# low; maintain SMAA10 low
3. 3. Deassert RESET# high; maintain SMAA10 low
4. 4. RESET# must be maintained high for the duration of testing.

No external clocking of the GMCH is required.