

IA-32 Intel[®] Architecture Optimization

Reference Manual

Issued in U.S.A.

Order Number: 248966-008

World Wide Web: <http://developer.intel.com>



INFORMATION IN THIS DOCUMENT IS PROVIDED IN CONNECTION WITH INTEL PRODUCTS. NO LICENSE, EXPRESS OR IMPLIED, BY ESTOPPEL OR OTHERWISE, TO ANY INTELLECTUAL PROPERTY RIGHTS IS GRANTED BY THIS DOCUMENT. EXCEPT AS PROVIDED IN INTEL'S TERMS AND CONDITIONS OF SALE FOR SUCH PRODUCTS, INTEL ASSUMES NO LIABILITY WHATSOEVER, AND INTEL DISCLAIMS ANY EXPRESS OR IMPLIED WARRANTY, RELATING TO SALE AND/OR USE OF INTEL PRODUCTS INCLUDING LIABILITY OR WARRANTIES RELATING TO FITNESS FOR A PARTICULAR PURPOSE, MERCHANTABILITY, OR INFRINGEMENT OF ANY PATENT, COPYRIGHT OR OTHER INTELLECTUAL PROPERTY RIGHT. Intel products are not intended for use in medical, life saving, or life sustaining applications. Intel may make changes to specifications and product descriptions at any time, without notice.

This IA-32 Intel® Architecture Optimization Reference Manual as well as the software described in it is furnished under license and may only be used or copied in accordance with the terms of the license. The information in this manual is furnished for informational use only, is subject to change without notice, and should not be construed as a commitment by Intel Corporation. Intel Corporation assumes no responsibility or liability for any errors or inaccuracies that may appear in this document or any software that may be provided in association with this document.

Except as permitted by such license, no part of this document may be reproduced, stored in a retrieval system, or transmitted in any form or by any means without the express written consent of Intel Corporation.

Designers must not rely on the absence or characteristics of any features or instructions marked "reserved" or "undefined." Intel reserves these for future definition and shall have no responsibility whatsoever for conflicts or incompatibilities arising from future changes to them.

Intel, Pentium, Intel Xeon, Intel NetBurst, Itanium, MMX, and VTune are trademarks or registered trademarks of Intel Corporation or its subsidiaries in the United States and other countries.

*Other names and brands may be claimed as the property of others.

Copyright © 1999-2003 Intel Corporation.

Contents

Introduction

Tuning Your Application	xxiv
About This Manual	xxv
Related Documentation.....	xxvii
Notational Conventions	xxviii

Chapter 1 IA-32 Intel® Architecture Processor Family Overview

SIMD Technology	1-2
Summary of SIMD Technologies	1-5
MMX™ Technology.....	1-5
Streaming SIMD Extensions	1-5
Streaming SIMD Extensions 2.....	1-6
Intel® NetBurst™ Microarchitecture	1-6
Design Goals of Intel NetBurst Microarchitecture	1-7
Overview of the Intel NetBurst Microarchitecture Pipeline	1-8
The Front End.....	1-10
The Out-of-order Core	1-11
Retirement.....	1-12
Front End Pipeline Detail.....	1-12
Prefetching.....	1-13
Decoder	1-13
Execution Trace Cache	1-13
Branch Prediction	1-14
Execution Core Detail.....	1-16
Instruction Latency and Throughput	1-16
Execution Units and Issue Ports.....	1-17
Caches.....	1-18
Data Prefetch.....	1-20
Loads and Stores.....	1-22
Store Forwarding	1-23

Intel® Pentium® M Processor Microarchitecture	1-24
The Front End.....	1-26
Data Prefetching	1-27
Out-of-Order Core.....	1-28
In-Order Retirement.....	1-28
Hyper-Threading Technology	1-28
Processor Resources and Hyper-Threading Technology.....	1-30
Replicated Resources.....	1-31
Partitioned Resources	1-31
Shared Resources	1-32
Microarchitecture Pipeline and Hyper-Threading Technology	1-32
Front End Pipeline	1-33
Execution Core.....	1-33
Retirement.....	1-33

Chapter 2 General Optimization Guidelines

Tuning to Achieve Optimum Performance	2-1
Tuning to Prevent Known Coding Pitfalls.....	2-2
General Practices and Coding Guidelines	2-3
Use Available Performance Tools.....	2-4
Optimize Performance Across Processor Generations	2-4
Optimize Branch Predictability.....	2-4
Optimize Memory Access.....	2-5
Optimize Floating-point Performance	2-5
Optimize Instruction Selection	2-6
Optimize Instruction Scheduling.....	2-7
Enable Vectorization.....	2-7
Coding Rules, Suggestions and Tuning Hints.....	2-7
Performance Tools	2-8
Intel® C++ Compiler	2-8
General Compiler Recommendations	2-9
VTune™ Performance Analyzer	2-10
Processor Perspectives	2-10
CPUID Dispatch Strategy and Compatible Code Strategy	2-12
Branch Prediction.....	2-13
Eliminating Branches.....	2-13
Spin-Wait and Idle Loops.....	2-16
Static Prediction.....	2-17
Inlining, Calls and Returns	2-20
Branch Type Selection	2-21

Loop Unrolling	2-25
Compiler Support for Branch Prediction	2-27
Memory Accesses	2-28
Alignment	2-28
Store Forwarding	2-31
Store-to-Load-Forwarding Restriction on Size and Alignment	2-32
Store-forwarding Restriction on Data Availability	2-37
Data Layout Optimizations	2-39
Stack Alignment	2-42
Aliasing Cases	2-43
Aliasing Cases in the Pentium. 4 and Intel® Xeon™ Processors	2-44
Aliasing Cases in the Pentium M Processor	2-45
Mixing Code and Data	2-46
Self-modifying Code	2-47
Write Combining	2-48
Locality Enhancement	2-49
Minimizing Bus Latency	2-50
Non-Temporal Store Bus Traffic	2-51
Prefetching	2-52
Hardware Instruction Fetching	2-53
Software and Hardware Cache Line Fetching	2-53
Cacheability instructions	2-54
Code Alignment	2-54
Improving the Performance of Floating-point Applications	2-55
Guidelines for Optimizing Floating-point Code	2-55
Floating-point Modes and Exceptions	2-57
Floating-point Exceptions	2-57
Floating-point Modes	2-60
Improving Parallelism and the Use of FXCH	2-65
x87 vs. SIMD Floating-point Trade-offs	2-66
Memory Operands	2-67
Floating-Point Stalls	2-68
x87 Floating-point Operations with Integer Operands	2-68
x87 Floating-point Comparison Instructions	2-68
Transcendental Functions	2-69
Instruction Selection	2-69
Complex Instructions	2-70
Use of the lea Instruction	2-70
Use of the inc and dec Instructions	2-71
Use of the shift and rotate Instructions	2-71

Integer and Floating-point Multiply	2-72
Integer Divide	2-72
Operand Sizes	2-73
Address Calculations	2-75
Clearing Registers	2-76
Compares	2-76
Floating Point/SIMD Operands	2-77
Prolog Sequences	2-79
Code Sequences that Operate on Memory Operands	2-79
Instruction Scheduling	2-80
Latencies and Resource Constraints	2-80
Spill Scheduling	2-81
Scheduling Rules for the Pentium 4 Processor Decoder	2-81
Scheduling Rules for the Pentium M Processor Decoder	2-82
Vectorization	2-82
Miscellaneous	2-84
NOPs	2-84
Summary of Rules and Suggestions	2-85
User/Source Coding Rules	2-86
Assembly/Compiler Coding Rules	2-89
Tuning Suggestions	2-97

Chapter 3 Coding for SIMD Architectures

Checking for Processor Support of SIMD Technologies	3-2
Checking for MMX Technology Support	3-2
Checking for Streaming SIMD Extensions Support	3-3
Checking for Streaming SIMD Extensions 2 Support	3-5
Considerations for Code Conversion to SIMD Programming	3-6
Identifying Hot Spots	3-8
Determine If Code Benefits by Conversion to SIMD Execution	3-9
Coding Techniques	3-10
Coding Methodologies	3-11
Assembly	3-13
Intrinsics	3-13
Classes	3-15
Automatic Vectorization	3-16
Stack and Data Alignment	3-18
Alignment and Contiguity of Data Access Patterns	3-18
Using Padding to Align Data	3-18
Using Arrays to Make Data Contiguous	3-19

Stack Alignment For 128-bit SIMD Technologies	3-20
Data Alignment for MMX Technology	3-21
Data Alignment for 128-bit data	3-22
Compiler-Supported Alignment	3-22
Improving Memory Utilization	3-25
Data Structure Layout	3-25
Strip Mining	3-30
Loop Blocking	3-32
Instruction Selection	3-35
Tuning the Final Application	3-37

Chapter 4 Optimizing for SIMD Integer Applications

General Rules on SIMD Integer Code	4-2
Using SIMD Integer with x87 Floating-point	4-3
Using the EMMS Instruction	4-3
Guidelines for Using EMMS Instruction	4-4
Data Alignment	4-6
Data Movement Coding Techniques	4-6
Unsigned Unpack	4-6
Signed Unpack	4-7
Interleaved Pack with Saturation	4-8
Interleaved Pack without Saturation	4-10
Non-Interleaved Unpack	4-11
Extract Word	4-13
Insert Word	4-14
Move Byte Mask to Integer	4-16
Packed Shuffle Word for 64-bit Registers	4-18
Packed Shuffle Word for 128-bit Registers	4-19
Unpacking/interleaving 64-bit Data in 128-bit Registers	4-20
Data Movement	4-21
Conversion Instructions	4-21
Generating Constants	4-21
Building Blocks	4-23
Absolute Difference of Unsigned Numbers	4-23
Absolute Difference of Signed Numbers	4-24
Absolute Value	4-25
Clipping to an Arbitrary Range [high, low]	4-26
Highly Efficient Clipping	4-27
Clipping to an Arbitrary Unsigned Range [high, low]	4-29

Packed Max/Min of Signed Word and Unsigned Byte.....	4-30
Signed Word.....	4-30
Unsigned Byte.....	4-30
Packed Multiply High Unsigned.....	4-30
Packed Sum of Absolute Differences.....	4-30
Packed Average (Byte/Word).....	4-31
Complex Multiply by a Constant.....	4-32
Packed 32*32 Multiply.....	4-33
Packed 64-bit Add/Subtract.....	4-33
128-bit Shifts.....	4-33
Memory Optimizations.....	4-34
Partial Memory Accesses.....	4-35
Increasing Bandwidth of Memory Fills and Video Fills.....	4-37
Increasing Memory Bandwidth Using the MOVDQ Instruction.....	4-37
Increasing Memory Bandwidth by Loading and Storing to and from the Same DRAM Page.....	4-38
Increasing UC and WC Store Bandwidth by Using Aligned Stores.....	4-38
Converting from 64-bit to 128-bit SIMD Integer.....	4-38

Chapter 5 Optimizing for SIMD Floating-point Applications

General Rules for SIMD Floating-point Code.....	5-1
Planning Considerations.....	5-2
Detecting SIMD Floating-point Support.....	5-3
Using SIMD Floating-point with x87 Floating-point.....	5-3
Scalar Floating-point Code.....	5-3
Data Alignment.....	5-4
Data Arrangement.....	5-4
Vertical versus Horizontal Computation.....	5-5
Data Swizzling.....	5-9
Data Deswizzling.....	5-13
Using MMX Technology Code for Copy or Shuffling Functions.....	5-16
Horizontal ADD.....	5-17
Use of cvttps2pi/cvtts2si Instructions.....	5-21
Flush-to-Zero Mode.....	5-21

Chapter 6 Optimizing Cache Usage

General Prefetch Coding Guidelines.....	6-2
Hardware Data Prefetch.....	6-4
Prefetch and Cacheability Instructions.....	6-5
Prefetch.....	6-5

Software Data Prefetch	6-6
The Prefetch Instructions – Pentium 4 Processor Implementation.....	6-7
Prefetch and Load Instructions.....	6-8
Cacheability Control.....	6-9
The Non-temporal Store Instructions.....	6-9
Fencing.....	6-10
Streaming Non-temporal Stores	6-10
Memory Type and Non-temporal Stores	6-11
Write-Combining.....	6-12
Streaming Store Usage Models.....	6-13
Coherent Requests.....	6-13
Non-coherent requests	6-13
Streaming Store Instruction Descriptions	6-14
The fence Instructions	6-15
The sfence Instruction	6-15
The lfence Instruction	6-16
The mfence Instruction	6-16
The cflush Instruction	6-17
Memory Optimization Using Prefetch.....	6-18
Software-controlled Prefetch	6-18
Hardware Prefetch	6-19
Example of Latency Hiding with S/W Prefetch Instruction	6-20
Prefetching Usage Checklist	6-22
Prefetch Scheduling Distance	6-23
Prefetch Concatenation.....	6-24
Minimize Number of Prefetches	6-26
Mix Prefetch with Computation Instructions	6-30
Prefetch and Cache Blocking Techniques.....	6-32
Single-pass versus Multi-pass Execution	6-37
Memory Optimization using Non-Temporal Stores.....	6-40
Non-temporal Stores and Software Write-Combining.....	6-40
Cache Management	6-41
Video Encoder	6-42
Video Decoder	6-42
Conclusions from Video Encoder and Decoder Implementation	6-43
Using Prefetch and Streaming-store for a Simple Memory Copy	6-43
TLB Priming.....	6-44
Optimizing the 8-byte Memory Copy	6-45

Chapter 7 Multiprocessor and Hyper-Threading Technology

Performance and Usage Models.....	7-2
Multithreading.....	7-2
Multitasking Environment	7-4
Programming Models and Multithreading	7-5
Parallel Programming Models	7-6
Domain Decomposition.....	7-6
Functional Decomposition	7-7
Tools for Creating Multithreaded Applications	7-8
Optimization Guidelines	7-9
Key Practices of Thread Synchronization	7-10
Key Practices of System Bus Optimization	7-10
Key Practices of Memory Optimization	7-11
Key Practices of Front-end Optimization	7-12
Key Practices of Execution Resource Optimization	7-12
Generality and Performance Impact.....	7-12
Thread Synchronization	7-13
Synchronization for Short Periods	7-13
Optimization with Spin-Locks	7-17
Synchronization for Longer Periods	7-18
Avoid Coding Pitfalls in Thread Synchronization	7-19
Prevent False-Sharing of Data	7-21
Placement of Shared Synchronization Variable	7-22
System Bus Optimization	7-22
Conserve Bus Command Bandwidth.....	7-23
Avoid Excessive Software Prefetches.....	7-23
Improve Effective Latency of Cache Misses.....	7-24
Use Full Write Transactions to Achieve Higher Data Rate	7-25
Memory Optimization	7-25
Cache Blocking Technique	7-26
Shared-Memory Optimization.....	7-26
Minimize Sharing of Data between Physical Processors.....	7-26
Eliminate 64-K-Aliased Data Accesses	7-27
Preventing Excessive Evictions in First-Level Data Cache	7-28
Per-thread Stack Offset	7-29
Per-instance Stack Offset	7-31
Front-end Optimization.....	7-33
Avoid Excessive Loop Unrolling	7-33
Optimization for Code Size.....	7-33

Execution Resource Optimization	7-34
Optimization Priorities	7-35
Managing Heavily-Used Execution Resources	7-37

Appendix A Application Performance Tools

Intel® Compilers	A-2
Code Optimization Options	A-3
Targeting a Processor (-Gn)	A-3
Automatic Processor Dispatch Support (-Qx[extensions] and -Qax[extensions]).....	A-4
Vectorizer Switch Options	A-5
Prefetching.....	A-5
Loop Unrolling.....	A-5
Multithreading with OpenMP.....	A-5
Inline Expansion of Library Functions (-Oi, -Oi-)	A-6
Floating-point Arithmetic Precision (-Op, -Op-, -Qprec, -Qprec_div, -Qpc, -Qlong_double).....	A-6
Rounding Control Option (-Qrcd)	A-6
Interprocedural and Profile-Guided Optimizations	A-6
Interprocedural Optimization (IPO).....	A-6
Profile-Guided Optimization (PGO)	A-7
Intel® VTune™ Performance Analyzer.....	A-8
Sampling	A-8
Time-based Sampling.....	A-8
Event-based Sampling.....	A-9
Call Graph	A-10
Counter Monitor.....	A-11
Intel® Tuning Assistant	A-11
Intel Performance Libraries	A-12
Benefits Summary	A-13
Libraries Architecture	A-13
Optimizations with the Intel Performance Libraries	A-14
Enhanced Debugger (EDB)	A-15
Intel® Threading Tools.....	A-15
Intel Thread Checker.....	A-15
Thread Profiler.....	A-16
Intel® Software College	A-16

Appendix B Intel Pentium 4 Processor Performance Metrics

Pentium 4 Processor-Specific Terminology.....	B-1
Bogus, Non-bogus, Retire	B-1
Bus Ratio	B-2
Replay	B-2
Assist.....	B-3
Tagging.....	B-3
Counting Clocks.....	B-3
Non-Halted Clockticks	B-5
Non-Sleep Clockticks	B-5
Time Stamp Counter.....	B-7
Microarchitecture Notes	B-7
Trace Cache Events	B-7
Bus and Memory Metrics.....	B-8
Reads due to program loads	B-10
Reads due to program writes (RFOs).....	B-10
Writebacks (dirty evictions).....	B-10
Usage Notes for Specific Metrics	B-11
Usage Notes on Bus Activities	B-13
Metrics Descriptions and Categories	B-14
Performance Metrics and Tagging Mechanisms	B-45
Tags for replay_event	B-45
Tags for front_end_event.....	B-46
Tags for execution_event	B-47
Using Performance Metrics with Hyper-Threading Technology	B-49

Appendix C IA-32 Instruction Latency and Throughput

Overview	C-1
Definitions	C-3
Latency and Throughput	C-4
Latency and Throughput with Register Operands.....	C-5
Table Footnotes	C-16
Latency and Throughput with Memory Operands	C-18

Appendix D Stack Alignment

Stack Frames D-1
 Aligned esp-Based Stack Frames D-4
 Aligned ebp-Based Stack Frames D-6
 Stack Frame Optimizations..... D-9
 Inlined Assembly and ebx D-10

Appendix E Mathematics of Prefetch Scheduling Distance

Simplified Equation E-1
 Mathematical Model for PSD E-2
 No Preloading or Prefetch E-6
 Compute Bound (Case: $T_c \geq T_l + T_b$) E-7
 Compute Bound (Case: $T_l + T_b > T_c > T_b$) E-8
 Memory Throughput Bound (Case: $T_b \geq T_c$) E-9
 Example E-11

Index

Examples

Example 2-1	Assembly Code with an Unpredictable Branch	2-15
Example 2-2	Code Optimization to Eliminate Branches.....	2-15
Example 2-3	Eliminating Branch with CMOV Instruction	2-16
Example 2-4	Use of <code>pause</code> Instruction.....	2-17
Example 2-5	Pentium 4 Processor Static Branch Prediction Algorithm	2-18
Example 2-6	Static Taken Prediction Example.....	2-19
Example 2-7	Static Not-Taken Prediction Example.....	2-19
Example 2-8	Indirect Branch With Two Favored Targets	2-24
Example 2-9	A Peeling Technique to Reduce Indirect Branch Misprediction.....	2-25
Example 2-10	Loop Unrolling	2-27
Example 2-11	Code That Causes Cache Line Split.....	2-30
Example 2-12	Several Situations of Small Loads After Large Store	2-34
Example 2-13	A Non-forwarding Example of Large Load After Small Store.....	2-35
Example 2-14	A Non-forwarding Situation in Compiler Generated Code	2-35
Example 2-15	Two Examples to Avoid the Non-forwarding Situation in Example 2-14	2-36
Example 2-16	Large and Small Load Stalls	2-37
Example 2-17	An Example of Loop-carried Dependence Chain.....	2-38
Example 2-18	Rearranging a Data Structure	2-39
Example 2-19	Decomposing an Array.....	2-40
Example 2-20	Dynamic Stack Alignment	2-43
Example 2-21	Non-temporal stores and 64-byte bus write transactions.....	2-52
Example 2-22	Non-temporal stores and partial bus write transactions.....	2-52
Example 2-23	Algorithm to Avoid Changing the Rounding Mode	2-63
Example 2-24	Dependencies Caused by Referencing Partial Registers	2-73
Example 2-25	Recombining LOAD/OP Code into REG, MEM Form	2-80
Example 2-26	Spill Scheduling Example Code	2-81
Example 3-1	Identification of MMX Technology with <code>cpuid</code>	3-3
Example 3-2	Identification of SSE with <code>cpuid</code>	3-4
Example 3-3	Identification of SSE by the OS.....	3-4
Example 3-4	Identification of SSE2 with <code>cpuid</code>	3-5
Example 3-5	Identification of SSE2 by the OS.....	3-6
Example 3-6	Simple Four-Iteration Loop.....	3-12
Example 3-7	Streaming SIMD Extensions Using Inlined Assembly Encoding.....	3-13

Example 3-8	Simple Four-Iteration Loop Coded with Intrinsics	3-14
Example 3-9	C++ Code Using the Vector Classes.....	3-16
Example 3-10	Automatic Vectorization for a Simple Loop	3-17
Example 3-11	C Algorithm for 64-bit Data Alignment.....	3-21
Example 3-12	AoS Data Structure	3-25
Example 3-13	SoA Data Structure	3-26
Example 3-14	AoS and SoA Code Samples	3-27
Example 3-15	Hybrid SoA data structure	3-29
Example 3-16	Pseudo-code Before Strip Mining	3-31
Example 3-17	Strip Mined Code	3-32
Example 3-18	Loop Blocking.....	3-33
Example 3-19	Emulation of Conditional Moves.....	3-36
Example 4-1	Resetting the Register between <code>__m64</code> and FP Data Types	4-5
Example 4-2	Unsigned Unpack Instructions	4-7
Example 4-3	Signed Unpack Code	4-8
Example 4-4	Interleaved Pack with Saturation.....	4-10
Example 4-5	Interleaved Pack without Saturation.....	4-11
Example 4-6	Unpacking Two Packed-word Sources in a Non-interleaved Way	4-13
Example 4-7	<code>pextrw</code> Instruction Code	4-14
Example 4-8	<code>pinsrw</code> Instruction Code.....	4-15
Example 4-9	Repeated <code>pinsrw</code> Instruction Code	4-16
Example 4-10	<code>pmovmskb</code> Instruction Code.....	4-17
Example 4-11	Broadcast Using 2 Instructions	4-19
Example 4-12	<code>pshuf</code> Instruction Code	4-19
Example 4-13	Swap Using 3 Instructions.....	4-20
Example 4-14	Reverse Using 3 Instructions	4-20
Example 4-15	Generating Constants	4-22
Example 4-16	Absolute Difference of Two Unsigned Numbers	4-23
Example 4-17	Absolute Difference of Signed Numbers	4-25
Example 4-18	Computing Absolute Value.....	4-26
Example 4-19	Clipping to a Signed Range of Words [high, low].....	4-27
Example 4-20	Simplified Clipping to an Arbitrary Signed Range	4-28
Example 4-21	Clipping to an Arbitrary Signed Range [high, low].....	4-28
Example 4-22	Clipping to an Arbitrary Unsigned Range [high, low].....	4-29
Example 4-23	Complex Multiply by a Constant.....	4-32
Example 4-24	A Large Load after a Series of Small Stores (Penalty)	4-35
Example 4-25	Accessing Data without Delay.....	4-35
Example 4-26	A Series of Small Loads after a Large Store.....	4-36
Example 4-27	Eliminating Delay for a Series of Small Loads after a Large Store	4-36
Example 5-1	Pseudocode for Horizontal (xyz, AoS) Computation.....	5-7
Example 5-2	Pseudocode for Vertical (xxxx, yyyy, zzzz, SoA) Computation	5-8
Example 5-3	Swizzling Data.....	5-9
Example 5-4	Swizzling Data Using Intrinsics	5-11

Example 5-5	Deswizzling Single-Precision SIMD Data.....	5-13
Example 5-6	Deswizzling Data Using the movhlps and shuffle Instructions.....	5-15
Example 5-7	Deswizzling Data 64-bit Integer SIMD Data.....	5-16
Example 5-8	Using MMX Technology Code for Copying or Shuffling.....	5-17
Example 5-9	Horizontal Add Using movhlps/movhlps.....	5-19
Example 5-10	Horizontal Add Using Intrinsics with movhlps/movhlps.....	5-20
Example 6-1	Pseudo-code for Using cflush.....	6-19
Example 6-2	Prefetch Scheduling Distance.....	6-25
Example 6-3	Using Prefetch Concatenation.....	6-26
Example 6-4	Concatenation and Unrolling the Last Iteration of Inner Loop.....	6-27
Example 6-5	Spread Prefetch Instructions.....	6-32
Example 6-6	Data Access of a 3D Geometry Engine without Strip-mining.....	6-36
Example 6-7	Data Access of a 3D Geometry Engine with Strip-mining.....	6-37
Example 6-8	Basic Algorithm of a Simple Memory Copy.....	6-44
Example 6-9	An Optimized 8-byte Memory Copy.....	6-47
Example 7-1	Spin-wait Loop and PAUSE Instructions.....	7-15
Example 7-2	Coding Pitfall using Spin Wait Loop.....	7-20
Example 7-3	Placement of Synchronization and Regular Variables.....	7-22
Example 7-4	Adding an Offset to the Stack Pointer of Three Threads.....	7-30
Example 7-5	Adding an Offset to the Stack Pointer of Three Threads.....	7-31
Example 7-6	Adding a Pseudo-random Offset to the Stack Pointer in the Entry Function.....	7-33
Example D-1	Aligned esp-Based Stack Frames.....	D-5
Example D-2	Aligned ebp-based Stack Frames.....	D-7
Example E-1	Calculating Insertion for Scheduling Distance of 3.....	E-3

Figures

Figure 1-1	Typical SIMD Operations	1-3
Figure 1-2	SIMD Instruction Register Usage.....	1-4
Figure 1-3	The Intel NetBurst Microarchitecture.....	1-9
Figure 1-4	Execution Units and Ports in the Out-Of-Order Core	1-20
Figure 1-5	The Intel Pentium M processor Microarchitecture.....	1-26
Figure 1-6	Hyper-Threading Technology on an SMP	1-31
Figure 2-1	Cache Line Split in Accessing Elements in a Array	2-30
Figure 2-2	Size and Alignment Restrictions in Store Forwarding	2-33
Figure 3-1	Converting to Streaming SIMD Extensions Chart	3-7
Figure 3-2	Hand-Coded Assembly and High-Level Compiler Performance Trade-offs	3-11
Figure 3-3	Loop Blocking Access Pattern	3-35
Figure 4-1	Interleaved Pack with Saturation.....	4-9
Figure 4-2	PACKSSDW mm, mm/mm64 Instruction Example	4-9
Figure 4-3	Result of Non-Interleaved Unpack High in MM1	4-12
Figure 4-4	Result of Non-Interleaved Unpack Low in MM0.....	4-12
Figure 4-5	pextrw Instruction	4-14
Figure 4-6	pinsrw Instruction	4-15
Figure 4-7	pmovmskb Instruction Example	4-17
Figure 4-8	pshuf Instruction Example.....	4-18
Figure 4-9	PSADBW Instruction Example	4-31
Figure 5-1	Dot Product Operation	5-7
Figure 5-2	Horizontal Add Using movhlps/movlhps.....	5-18
Figure 6-1	Memory Access Latency and Execution With Prefetch.....	6-22
Figure 6-2	Memory Access Latency and Execution Without Prefetch.....	6-22
Figure 6-3	Prefetch and Loop Unrolling.....	6-28
Figure 6-4	Memory Access Latency and Execution With Prefetch.....	6-30
Figure 6-5	Cache Blocking – Temporally Adjacent and Non-adjacent Passes.....	6-34
Figure 6-6	Examples of Prefetch and Strip-mining for Temporally Adjacent and Non-Adjacent Passes Loops.....	6-35
Figure 6-7	Incorporating Prefetch into Strip-mining Code	6-38
Figure 6-8	Single-Pass Vs. Multi-Pass 3D Geometry Engines.....	6-40
Figure 7-1	Amdahl’s Law and MP Speed-up.....	7-3
Figure A-1	Sampling Analysis of Hotspots by Location	A-10

Figure B-1	Relationships Between the Cache Hierarchy, IOQ, BSQ and Front Side Bus.....	B-9
Figure D-1	Stack Frames Based on Alignment Type.....	D-3
Figure E-1	Pentium II, Pentium III and Pentium 4 Processors Memory Pipeline Sketch	E-4
Figure E-2	Execution Pipeline, No Preloading or Prefetch	E-6
Figure E-3	Compute Bound Execution Pipeline.....	E-7
Figure E-4	Another Compute Bound Execution Pipeline	E-8
Figure E-5	Memory Throughput Bound Pipeline.....	E-10
Figure E-6	Accesses per Iteration, Example 1.....	E-11
Figure E-7	Accesses per Iteration, Example 2.....	E-12

Tables

Table 1-1	Pentium 4 and Intel Xeon Processor Cache Parameters.....	1-21
Table 1-2	The Pentium M Processor Cache Parameters.....	1-29
Table 2-1	Coding Pitfalls Affecting Performance.....	2-2
Table 5-1	SoA Form of Representing Vertices Data	5-6
Table 6-1	Prefetch Implementation: Pentium III and Pentium 4 Processors.....	6-9
Table B-1	Pentium 4 Processor Performance Metrics.....	B-17
Table B-2	Metrics That Utilize Replay Tagging Mechanism	B-45
Table B-3	able 3 Metrics That Utilize the Front-end Tagging Mechanism	B-46
Table B-4	Metrics That Utilize the Execution Tagging Mechanism.....	B-48
Table B-5	Metrics That Support Qualification by Logical Processor and Parallel Counting.....	B-50
Table B-6	Metrics That Are Independent of Logical Processors	B-53
Table C-1	Streaming SIMD Extension 2 128-bit Integer Instructions	C-6
Table C-2	Streaming SIMD Extension 2 Double-precision Floating-point Instructions.....	C-9
Table C-3	Streaming SIMD Extension Single-precision Floating-point Instructions.....	C-10
Table C-4	Streaming SIMD Extension 64-bit Integer Instructions	C-12
Table C-5	MMX Technology 64-bit Instructions	C-13
Table C-6	IA-32 x87 Floating-point Instructions.....	C-14
Table C-7	IA-32 General Purpose Instructions	C-16

Introduction

The IA-32 Intel® Architecture Optimization Reference Manual describes how to optimize software to take advantage of the performance characteristics of the current generation of IA-32 Intel Architecture family of processors. The optimizations described in this manual apply to IA-32 processors based on the Intel® NetBurst™ microarchitecture, the Intel® Pentium® M processor family and IA-32 processors that support Hyper-Threading Technology.

The target audience for this manual includes software programmers and compiler writers. This manual assumes that the reader is familiar with the basics of the IA-32 architecture and has access to the three-volume set of manuals: *Intel® Architecture Software Developer's Manual: Volume 1, Basic Architecture*; *Volume 2, Instruction Set Reference*; and *Volume 3, System Programmer's Guide*.

When developing and optimizing software applications to achieve a high level of performance when running on IA-32 processors, a detailed understanding of IA-32 family of processors is often required. In many cases, knowledge of new IA-32 microarchitectures is also required.

This manual provides an overview of the Intel NetBurst microarchitecture and the Intel Pentium M processor microarchitecture. It contains design guidelines for high-performance software applications, coding rules, and techniques for many aspects of code-tuning. These rules are useful to programmers and compiler developers.

The design guidelines that are discussed in this manual for developing high-performance software apply to current as well as to future IA-32 processors. The coding rules and code optimization techniques listed target the Intel NetBurst microarchitecture and the Pentium M processor microarchitecture.

Tuning Your Application

Tuning an application for high performance on any IA-32 processor requires understanding and basic skills in:

- the IA-32 architecture
- C and Assembly language
- the hot-spot regions in your application that have significant impact on software performance
- the optimization capabilities of your compiler
- techniques to evaluate the application's performance.

The Intel® VTune™ Performance Analyzer can help you analyze and locate hot-spot regions in your applications. On the Pentium 4, Intel® Xeon™ and Pentium M processors, this tool can monitor an application through a selection of performance monitoring events and analyze the performance event data that is gathered during code execution.

This manual also describes information that can be gathered using the performance counters through Pentium 4 processor's performance monitoring events.

For VTune Performance Analyzer order information, see the web page: <http://developer.intel.com>

About This Manual

In this document, the reference “Pentium 4 processor” refers to processors based on the Intel NetBurst microarchitecture. Currently this includes the Intel Pentium 4 processor and Intel Xeon processor. Where appropriate, differences between Pentium 4 processor and Intel Xeon processor are noted.

The manual consists of the following parts:

Introduction. Defines the purpose and outlines the contents of this manual.

Chapter 1: IA-32 Intel® Architecture Processor Family Overview. Describes the features relevant to software optimization of the current generation of IA-32 Intel Architecture processors, including the architectural extensions to the IA-32 architecture and an overview of the Intel NetBurst microarchitecture, Pentium M processor microarchitecture and Hyper-Threading Technology.

Chapter 2: General Optimization Guidelines. Describes general code development and optimization techniques that apply to all applications designed to take advantage of the common features of the Intel NetBurst microarchitecture and Pentium M processor microarchitecture.

Chapter 3: Coding for SIMD Architectures. Describes techniques and concepts for using the SIMD integer and SIMD floating-point instructions provided by the MMX™ technology, Streaming SIMD Extensions, and Streaming SIMD Extensions 2.

Chapter 4: Optimizing for SIMD Integer Applications. Provides optimization suggestions and common building blocks for applications that use the 64-bit and 128-bit SIMD integer instructions.

Chapter 5: Optimizing for SIMD Floating-point Applications. Provides optimization suggestions and common building blocks for applications that use the single-precision and double-precision SIMD floating-point instructions.

Chapter 6—Optimizing Cache Usage.

Describes how to use the `prefetch` instruction and cache control management instructions to optimize cache usage.

Chapter 7—Multiprocessor and Hyper-Threading Technology.

Describes guidelines and techniques to optimize multithreaded applications to achieve optimal performance scaling when running on multiprocessor (MP) systems or MP systems using IA-32 processors with Hyper-Threading Technology.

Appendix A—Application Performance Tools. Introduces tools for analyzing and enhancing application performance without having to write assembly code.

Appendix B—Intel Pentium 4 Processor Performance Metrics.

Provides information that can be gathered using Pentium 4 processor's performance monitoring events. These performance metrics can help programmers determine how effectively an application is using the features of the Intel NetBurst microarchitecture.

Appendix C—IA-32 Instruction Latency and Throughput. Provides latency and throughput data for the IA-32 instructions. Instruction timing data specific to the Pentium 4 and Pentium M processors are provided.

Appendix D—Stack Alignment. Describes stack alignment conventions and techniques to optimize performance of accessing stack-based data.

Appendix E—The Mathematics of Prefetch Scheduling Distance.

Discusses the optimum spacing to insert `prefetch` instructions and presents a mathematical model for determining the prefetch scheduling distance (PSD) for your application.

Related Documentation

For more information on the Intel architecture, specific techniques, and processor architecture terminology referenced in this manual, see the following documents:

- *Intel® C++ Compiler User's Guide*
- *Intel® Fortran Compiler User's Guide*
- VTune Performance Analyzer online help
- *Intel® Architecture Software Developer's Manual:*
 - Volume 1: *Basic Architecture*, doc. number 245470
 - Volume 2: *Instruction Set Reference Manual*, doc. number 245471
 - Volume 3: *System Programmer's Guide*, doc. number 245472
- *Intel Processor Identification with the CPUID Instruction*, doc. number 241618.

Also, refer to the following Application Notes:

- *Adjusting Thread Stack Address To Improve Performance On Intel Xeon MP Hyper-Threading Technology Enabled Processors*
- *Detecting Hyper-Threading Technology Enabled Processors*
- *Using Spin-Loops on Intel Pentium 4 Processor and Intel Xeon Processor MP*

In addition, refer to publications in the following web sites:

- <http://developer.intel.com/technology/hyperthread>
- <http://cedar.intel.com/cgi-bin/ids.dll/topic.jsp?catCode=CDN>

Notational Conventions

This manual uses the following conventions:

<i>This type style</i>	Indicates an element of syntax, a reserved word, a keyword, a filename, instruction, computer output, or part of a program example. The text appears in lowercase unless uppercase is significant.
THIS TYPE STYLE	Indicates a value, for example, TRUE, CONST1, or a variable, for example, A, B, or register names MM0 through MM7. 1 indicates lowercase letter L in examples. 1 is the number 1 in examples. 0 is the uppercase O in examples. 0 is the number 0 in examples.
<i>This type style</i>	Indicates a placeholder for an identifier, an expression, a string, a symbol, or a value. Substitute one of these items for the placeholder.
... (ellipses)	Indicate that a few lines of the code are omitted.
<u>This type style</u>	Indicates a hypertext link.

IA-32 Intel® Architecture Processor Family Overview

1

This chapter gives an overview of the key features relevant to software optimization of the current generation of IA-32 processors, including Intel® Pentium® 4, Intel® Xeon™ processors, and Intel® Pentium® M processors. This overview provides the background for understanding the coding recommendations described in detail in later chapters.

The key features of the current generation of IA-32 processors that enable high performance are:

- SIMD instruction extensions including MMX™ technology, Streaming SIMD Extensions (SSE), and Streaming SIMD Extensions 2 (SSE2)
- Microarchitectures that enable executing instructions with high throughput at high clock rates, a high speed cache hierarchy and the ability to fetch data with high speed system bus
- Intel® processors supporting Hyper-Threading (HT) Technology¹

Intel Pentium 4 processors and Intel Xeon processors are based on Intel® NetBurst™ microarchitecture. The Intel Pentium M processor microarchitecture balances performance and low power consumption.

1. Hyper-Threading Technology requires a computer system with an Intel® Pentium® 4 processor an Intel® Xeon™ processor supporting HT Technology and an HT Technology enabled chipset, BIOS and operating system. Performance will vary depending on the specific hardware and software you use. See <http://www.intel.com/technology/hyperthread/index.htm> for more information. See also “Detecting Support for Hyper-Threading Technology Enabled Processors” application note for how to identify the presence of HT Technology.

SIMD Technology

One way to increase processor performance is to execute several computations in parallel. An good way to achieve this type of parallel execution is to use a single-instruction, multiple-data (SIMD) computation technique.

SIMD computations (see Figure 1-1) were introduced in the IA-32 architecture with MMX technology. MMX technology allows SIMD computations to be performed on packed byte, word, and doubleword integers. The integers are contained in a set of eight 64-bit registers called MMX registers (see Figure 1-2).

The Pentium III processor extended the SIMD computation model with the introduction of the Streaming SIMD Extensions (SSE). SSE allows SIMD computations to be performed on operands that contain four packed single-precision floating-point data elements. The operands can be in memory or in a set of eight 128-bit registers called the XMM registers (see Figure 1-2). SSE also extended SIMD computational capability by adding additional 64-bit MMX instructions.

Figure 1-1 shows a typical SIMD computation. Two sets of four packed data elements (X1, X2, X3, and X4, and Y1, Y2, Y3, and Y4) are operated on in parallel, with the same operation being performed on each corresponding pair of data elements (X1 and Y1, X2 and Y2, X3 and Y3, and X4 and Y4). The results of the four parallel computations are sorted as a set of four packed data elements.

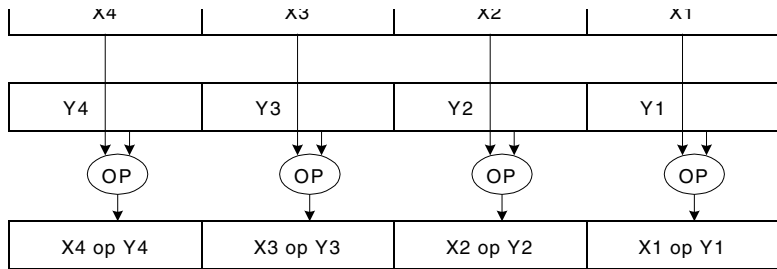
Figure 1-1 Typical SIMD Operations

OM15148

The Pentium 4 processor further extended the SIMD computation model with the introduction of Streaming SIMD Extensions 2 (SSE2). SSE2 works with operands in either memory or in the XMM registers. The technology extends SIMD computations to process packed double-precision floating-point data elements and 128-bit packed integers. There are 144 instructions in SSE2 that operate on two packed double-precision floating-point data elements; or on 16 packed byte, 8 packed word, 4 doubleword, and 2 quadword integers.

The full set of IA-32 SIMD technologies (MMX technology, SSE, and SSE2) give the programmer the ability to develop algorithms that combine operations on packed 64-bit and 128-bit integers and on single and double-precision floating-point operands.

Figure 1-2 SIMD Instruction Register Usage

64-bit MMX Registers	128-bit XMM Registers
MM7	XMM7
MM6	XMM6
MM5	XMM5
MM4	XMM4
MM3	XMM3
MM2	XMM2
MM1	XMM1
MM0	XMM0

OM15149

SIMD improves the performance of 3D graphics, speech recognition, image processing, scientific applications and applications that have the following characteristics:

- inherently parallel
- recurring memory access patterns
- localized recurring operations performed on the data
- data-independent control flow

SIMD floating-point instructions fully support the IEEE Standard 754 for Binary Floating-Point Arithmetic. They are accessible from all IA-32 execution modes: protected mode, real address mode, and Virtual 8086 mode.

SSE, SSE2, and MMX technologies are architectural extensions in the IA-32 Intel® architecture. Existing software will continue to run correctly, without modification on IA-32 microprocessors that incorporate these technologies. Existing software will also run correctly in the presence of applications that incorporate SIMD technologies.

SSE and SSE2 instructions also introduced cacheability and memory ordering instructions that can improve cache usage and application performance.

For more a more detailed introduction to SSE, SSE2 and MMX technologies, see also:

IA-32 Intel Architecture Software Developer's Manual, Vol. 1: Basic Architecture. Chapter 9: Programming with the Intel MMX Technology, Chapter 10: Programming with the Streaming SIMD Extensions (SSE), Chapter 11: Programming With the Streaming SIMD Extensions 2 (SSE2).

Summary of SIMD Technologies

These sections summarize the features of MMX technology, SSE, and SSE2.

MMX™ Technology

MMX Technology introduced:

- 64-bit MMX registers
- support for SIMD operations on packed byte, word, and doubleword integers

MMX instructions are useful for multimedia and communications software.

Streaming SIMD Extensions

SIMD extensions introduced:

- 128-bit XMM registers
- 128-bit data type with four packed single-precision floating-point operands
- data prefetch instructions

- non-temporal store instructions and other cacheability and memory ordering instructions
- extra 64-bit SIMD integer support

SSE instructions are useful for 3D geometry, 3D rendering, speech recognition, and video encoding and decoding.

Streaming SIMD Extensions 2

SIMD extensions add the following:

- 128-bit data type with two packed double-precision floating-point operands
- 128-bit data types for SIMD integer operation on 16-byte, 8-word, 4-doubleword, or 2-quadword integers
- support for SIMD arithmetic on 64-bit integer operands
- instructions for converting between new and existing data types
- extended support for data shuffling
- extended support for cacheability and memory ordering operations

SSE2 instructions are useful for 3D graphics, video decoding/encoding, and encryption.

Intel® NetBurst™ Microarchitecture

The Pentium 4 processor and the Intel Xeon processor implement the Intel NetBurst microarchitecture. This section describes the features of the Intel NetBurst microarchitecture and its operation on the Pentium 4 and Intel Xeon processors. It provides the technical background required to understand optimization recommendations the coding rules discussed in the rest of this manual. For implementation details, including instruction latencies, see “IA-32 Instruction Latency and Throughput” in Appendix C.

Intel NetBurst microarchitecture is designed to achieve high performance for both integer and floating-point computations at high clock rates. It supports the following features:

- hyper-pipelined technology that enables high clock rates and frequency headroom up to 10 GHz
- a high-performance, quad-pumped bus interface to the Intel NetBurst microarchitecture system bus
- a rapid execution engine to reduce the latency of basic integer instructions
- out-of-order speculative execution to enable parallelism
- superscalar issue to enable parallelism
- hardware register renaming to avoid register name space limitations
- cache line sizes of 64 bytes
- hardware prefetch

Design Goals of Intel NetBurst Microarchitecture

The design goals of Intel NetBurst microarchitecture are:

- to execute both legacy IA-32 applications and applications based on single-instruction, multiple-data (SIMD) technology at high throughput
- to operate at high clock rates and to scale to higher performance and clock rates in the future

Design advances of the Intel NetBurst microarchitecture include:

- A deeply pipelined design that allows high clock rates with different parts of the chip running at different clock rates, some faster and some slower than the nominally-quoted clock frequency of the processor.

- A pipeline that optimizes for the common case of frequently executed instructions. This means that the most frequently-executed instructions in common circumstances (such as a cache hit) are decoded efficiently and executed with short latencies.
- Employment of techniques to hide stall penalties. Among these are parallel execution, buffering, and speculation. The microarchitecture executes instructions dynamically and out-of-order, so the time it takes to execute each individual instruction is not always deterministic.

Chapter 2 recommends optimizations to use and situations to avoid. The chapter also gives a sense of relative priority. It does not absolutely quantify expected benefits and penalties (this is not possible to do this with an architecture of this complexity).

The following sections provide more information about key features of the Intel NetBurst microarchitecture.

Overview of the Intel NetBurst Microarchitecture Pipeline

The pipeline of the Intel NetBurst microarchitecture contains the:

- in-order issue front end
- out-of-order superscalar execution core
- in-order retirement unit

The front end supplies instructions in program order to the out-of-order core. It fetches and decodes IA-32 instructions. The decoded IA-32 instructions are translated into micro-operations (μ ops). The front end's primary job is to feed a continuous stream of μ ops to the execution core in original program order.

The out-of-order core aggressively reorders μ ops so that μ ops whose inputs are ready (and have execution resources available) can execute as soon as possible. The core can issue multiple μ ops per cycle.

The retirement section ensures that the results of execution are processed according to original program order and that the proper architectural states are updated.

Figure 1-3 illustrates a diagram of the major functional blocks associated with the Intel NetBurst microarchitecture pipeline. The following subsections provide an overview for each.

Figure 1-3 The Intel NetBurst Microarchitecture

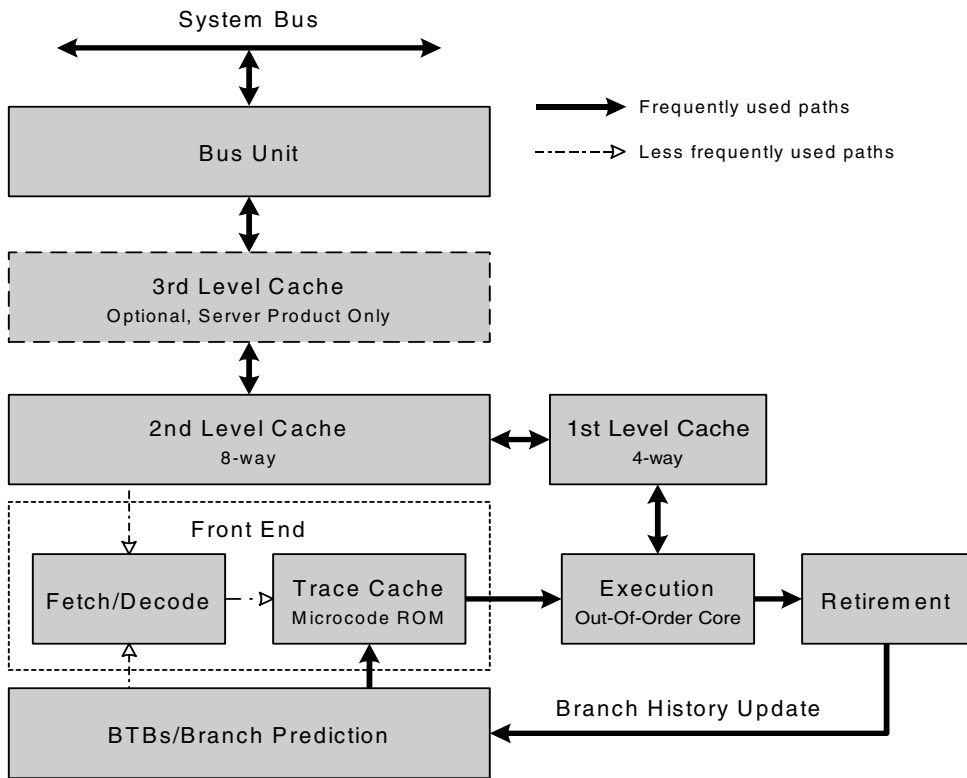

OM15150

The Front End

The front end of the Intel NetBurst microarchitecture consists of two parts:

- fetch/decode unit
- execution trace cache

It performs the following functions:

- prefetches IA-32 instructions that are likely to be executed
- fetches required instructions that have not been prefetched
- decodes instructions into μ ops
- generates microcode for complex instructions and special-purpose code
- delivers decoded instructions from the execution trace cache
- predicts branches using advanced algorithms

The front end is designed to address common problems in high-speed, pipelined microprocessors. Two problems that are sources of delays are:

- the time required to decode instructions fetched from the target
- wasted decode bandwidth due to branches or a branch target in the middle of a cache line

The execution trace cache addresses these problems by prefetching and storing decoded IA-32 instructions. Instructions are fetched and decoded by a translation engine. The translation engine then builds decoded instructions into μ ops sequences called traces. Traces are then stored in the execution trace cache.

The execution trace cache stores μ ops in the path of program execution flow, where the results of branches in the code are integrated into the same cache line. This increases the instruction flow from the cache and makes better use of the overall cache storage space since the cache no longer stores instructions that are branched over and never executed.

The trace cache can deliver up to 3 μ ops per clock to the core.

The execution trace cache and the translation engine have cooperating branch prediction hardware. Branch targets are predicted based on their linear address using branch prediction logic and fetched as soon as possible. Branch targets are fetched from the execution trace cache if they are cached, otherwise they are fetched from the memory hierarchy. The translation engine's branch prediction information is used to form traces along the most likely paths.

The Out-of-order Core

The core's ability to execute instructions out of order is a key factor in enabling parallelism. This feature enables the processor to reorder instructions so that if one μ op is delayed while waiting for data or a contended resource, other μ ops that appear later in the program order may proceed. This implies that when one portion of the pipeline experiences a delay, the delay may be covered by other operations executing in parallel or by the execution of μ ops queued up in a buffer. The delays described in this chapter must be understood in this context.

The core is designed to facilitate parallel execution. It can dispatch up to six μ ops per cycle through the issue ports (Figure 1-4, page 1-18). Note that six μ ops per cycle exceeds the trace cache and retirement μ op bandwidth. The higher bandwidth in the core allows for peak bursts of greater than three μ ops and to achieve higher issue rates by allowing greater flexibility in issuing μ ops to different execution ports.

Most core execution units can start executing a new μ op every cycle, so several instructions can be in flight at one time in each pipeline. A number of arithmetic logical unit (ALU) instructions can start at two per cycle; many floating-point instructions start one every two cycles. Finally, μ ops can begin execution out of program order, as soon as their data inputs are ready and resources are available.

Retirement

The retirement section receives the results of the executed μ ops from the execution core and processes the results so that the architectural state is updated according to the original program order. For semantically correct execution, the results of IA-32 instructions must be committed in original program order before they are retired. Exceptions may be raised as instructions are retired. For this reason, exceptions cannot occur speculatively.

When a μ op completes and writes its result to the destination, it is retired. Up to three μ ops may be retired per cycle. The reorder buffer (ROB) is the unit in the processor which buffers completed μ ops, updates the architectural state and manages the ordering of exceptions.

The retirement section also keeps track of branches and sends updated branch target information to the branch target buffer (BTB). This updates branch history. Figure 1-3 illustrates the paths that are most frequently executing inside the Intel NetBurst microarchitecture: an execution loop that interacts with multilevel cache hierarchy and the system bus.

The following sections describe in more detail the operation of the front end and the execution core. This information provides the background for using the optimization techniques and instruction latency data documented in this manual.

Front End Pipeline Detail

The following information about the front end operation is be useful for tuning software with respect to prefetching, branch prediction, and execution trace cache operations.

Prefetching

The Intel NetBurst microarchitecture supports three prefetching mechanisms:

- The first mechanism is a hardware instruction fetcher that automatically prefetches instructions.
- The second is a hardware mechanism that automatically fetches data and instructions into the unified second-level cache.
- The third mechanism fetches data only and includes two distinct components: (1) a hardware mechanism to fetch the adjacent cache line within an 128-byte sector that contains the data needed due to a cache line miss, this is also referred to as adjacent cache line prefetch (2) a software controlled mechanism that fetches data into the caches using the prefetch instructions.

The hardware instruction fetcher reads instructions along the path predicted by the branch target buffer (BTB) into instruction streaming buffers. Data is read in 32-byte chunks starting at the target address. The second and third mechanisms are described later.

Decoder

The front end of the Intel NetBurst microarchitecture has a single decoder that decodes instructions at the maximum rate of one instruction per clock. Some complex instructions must enlist the help of the microcode ROM. The decoder operation is connected to the execution trace cache.

Execution Trace Cache

The execution trace cache (TC) is the primary instruction cache in the Intel NetBurst microarchitecture. The TC stores decoded IA-32 instructions (μ ops).

In the Pentium 4 processor implementation, TC can hold up to 12K μ ops and can deliver up to three μ ops per cycle. TC does not hold all of the μ ops that need to be executed in the execution core. In some situations, the execution core may need to execute a microcode flow instead of the μ op traces that are stored in the trace cache.

The Pentium 4 processor is optimized so that most frequently-executed IA-32 instructions come from the trace cache while only a few instructions involve the microcode ROM.

Branch Prediction

Branch prediction is important to the performance of a deeply pipelined processor. It enables the processor to begin executing instructions long before the branch outcome is certain. Branch delay is the penalty that is incurred in the absence of correct prediction. For Pentium 4 and Intel Xeon processors, the branch delay for a correctly predicted instruction can be as few as zero clock cycles. The branch delay for a mispredicted branch can be many cycles, usually equivalent to the pipeline depth.

Branch prediction in the Intel NetBurst microarchitecture predicts all near branches (conditional calls, unconditional calls, returns and indirect branches). It does not predict far transfers (far calls, irets and software interrupts).

Mechanisms have been implemented to aid in predicting branches accurately and to reduce the cost of taken branches. These include:

- the ability to dynamically predict the direction and target of branches based on an instruction's linear address, using the branch target buffer (BTB)
- if no dynamic prediction is available or if it is invalid, the ability to statically predict the outcome based on the offset of the target: a backward branch is predicted to be taken, a forward branch is predicted to be not taken
- the ability to predict return addresses using the 16-entry return address stack

- the ability to build a trace of instructions across predicted taken branches to avoid branch penalties.

The Static Predictor. Once a branch instruction is decoded, the direction of the branch (forward or backward) is known. If there was no valid entry in the BTB for the branch, the static predictor makes a prediction based on the direction of the branch. The static prediction mechanism predicts backward conditional branches (those with negative displacement, such as loop-closing branches) as taken. Forward branches are predicted not taken.

To take advantage of the forward-not-taken and backward-taken static predictions, code should be arranged so that the likely target of the branch immediately follows forward branches (see also “Branch Prediction” in Chapter 2).

Branch Target Buffer. Once branch history is available, the Pentium 4 processor can predict the branch outcome even before the branch instruction is decoded. The processor uses a branch history table and a branch target buffer (collectively called the BTB) to predict the direction and target of branches based on an instruction’s linear address. Once the branch is retired, the BTB is updated with the target address.

Return Stack. Returns are always taken; but since a procedure may be invoked from several call sites, a single predicted target does not suffice. The Pentium 4 processor has a Return Stack that can predict return addresses for a series of procedure calls. This increases the benefit of unrolling loops containing function calls. It also mitigates the need to put certain procedures inline since the return penalty portion of the procedure call overhead is reduced.

Even if the direction and target address of the branch are correctly predicted, a taken branch may reduce available parallelism in a typical processor (since the decode bandwidth is wasted for instructions which immediately follow the branch and precede the target, if the branch does not end the line and target does not begin the line). The branch predictor allows a branch and its target to coexist in a single trace cache line, maximizing instruction delivery from the front end.

Execution Core Detail

The execution core is designed to optimize overall performance by handling common cases most efficiently. The hardware is designed to execute frequent operations in a common context as fast as possible, at the expense of infrequent operations using rare contexts.

Some parts of the core may speculate that a common condition holds to allow faster execution. If it does not, the machine may stall. An example of this pertains to store-to-load forwarding (see “Store Forwarding” in this chapter). If a load is predicted to be dependent on a store, it gets its data from that store and tentatively proceeds. If the load turned out not to depend on the store, the load is delayed until the real data has been loaded from memory, then it proceeds.

Instruction Latency and Throughput

The superscalar out-of-order core contains hardware resources that can execute multiple μ ops in parallel. The core’s ability to make use of available parallelism of execution units can be enhanced by software’s ability to:

- select IA-32 instructions that can be decoded in less than 4 μ ops and/or have short latencies
- order IA-32 instructions to preserve available parallelism by minimizing long dependence chains and covering long instruction latencies
- order instructions so that their operands are ready and their corresponding issue ports and execution units are free when they reach the scheduler

This subsection describes port restrictions, result latencies, and issue latencies (also referred to as throughput). These concepts form the basis to assist software for ordering instructions to increase parallelism. The order that μ ops are presented to the core of the processor is further affected by the machine’s scheduling resources.

It is the execution core that reacts to an ever-changing machine state, reordering μ ops for faster execution or delaying them because of dependence and resource constraints. The ordering of instructions in software is more of a suggestion to the hardware.

“IA-32 Instruction Latency and Throughput” in Appendix C, lists the IA-32 instructions with their latency, their issue throughput, and associated execution units (where relevant). Some execution units are not pipelined (meaning that μ ops cannot be dispatched in consecutive cycles and the throughput is less than one per cycle). The number of μ ops associated with each instruction provides a basis for selecting instructions to generate. All μ ops executed out of the microcode ROM involve extra overhead.

Execution Units and Issue Ports

At each cycle, the core may dispatch μ ops to one or more of four issue ports. At the micro-architecture level, store operations are further divided into two parts: store data and store address operations. The four ports through which μ ops are dispatched to execution units and to load and store operations are shown in Figure 1-4. Some ports can dispatch two μ ops per clock. Those execution units are marked Double Speed.

Port 0. In the first half of the cycle, port 0 can dispatch either one floating-point move μ op (a floating-point stack move, floating-point exchange or floating-point store data), or one arithmetic logical unit (ALU) μ op (arithmetic, logic or store data). In the second half of the cycle, it can dispatch one similar ALU μ op.

Port 1. In the first half of the cycle, port 1 can dispatch either one floating-point execution (all floating-point operations except moves, all SIMD operations) μ op or one normal-speed integer (multiply, shift and rotate) μ op or one ALU (arithmetic, logic or branch) μ op. In the second half of the cycle, it can dispatch one similar ALU μ op.

Port 2. This port supports the dispatch of one load operation per cycle.

Port 3. This port supports the dispatch of one store address operation per cycle.

The total issue bandwidth can range from zero to six μ ops per cycle. Each pipeline contains several execution units. The μ ops are dispatched to the pipeline that corresponds to the correct type of operation. For example, an integer arithmetic logic unit and the floating-point execution units (adder, multiplier, and divider) can share a pipeline.

Figure 1-4 Execution Units and Ports in the Out-Of-Order Core

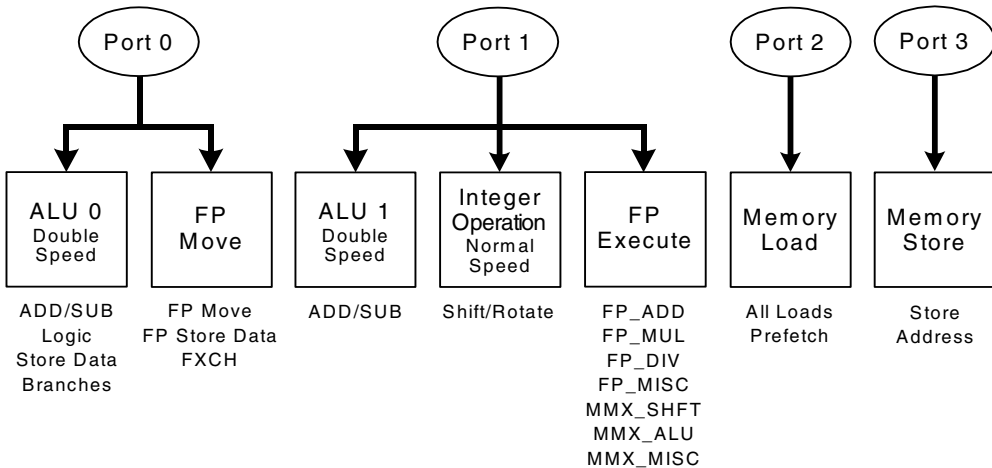

Note:

FP_ADD refers to x87 FP, and SIMD FP add and subtract operations
 FP_MUL refers to x87 FP, and SIMD FP multiply operations
 FP_DIV refers to x87 FP, and SIMD FP divide and square root operations
 MMX_ALU refers to SIMD integer arithmetic and logic operations
 MMX_SHFT handles Shift, Rotate, Shuffle, Pack and Unpack operations
 MMX_MISC handles SIMD reciprocal and some integer operations

OM15151

Caches

The Intel NetBurst microarchitecture supports up to three levels of on-chip cache. Two levels of on-chip cache are actually implemented in the Pentium 4 processor.

The first level cache (nearest to the execution core) contains separate caches for instructions and data. These include the first-level data cache and the trace cache (an advanced first-level instruction cache). All other caches are shared between instructions and data.

Levels in the cache hierarchy are not inclusive. The fact that a line is in level i does not imply that it is also in level $i+1$. All caches use a pseudo-LRU (least recently used) replacement algorithm.

Table 1-1 provides parameters for all cache levels.

Table 1-1 Pentium 4 and Intel Xeon Processor Cache Parameters

Level	Capacity	Associa- tivity (ways)	Line Size (bytes)	Access Latency, Integer/floating-p oint (clocks)	Write Update Policy
First	8 KB	4	64	2/9	write through
TC	12K μ ops	8	N/A	N/A	N/A
Second	256 KB or 512 KB ²	8	64 ¹	7/7	write back
Third	0, 512 KB, or 1 MB	8	64 ¹	14/14	write back

¹ Each read due to a cache miss fetches a sector, consisting of two adjacent cache lines; write operation is 64 bytes only.

² Pentium 4 and Intel Xeon processors with CPUID model encoding value of 2 have a second level cache of 512 KB.

On processors without a third level cache, the second-level cache miss initiates a transaction across the system bus interface to the memory sub-system. On processors with a third level cache, the third-level cache miss initiates a transaction across the system bus. A bus write transaction writes 64 bytes to cacheable memory, or separate 8-byte chunks if the destination is not cacheable. A bus read transaction from cacheable memory fetches two cache lines of data.

The system bus interface supports using a scalable bus clock and achieves an effective speed that quadruples the speed of the scalable bus clock. It takes on the order of 12 processor cycles to get to the bus and back within the processor, and 6-12 bus cycles to access memory if there is no bus congestion. Each bus cycle equals several processor

cycles. The ratio of processor clock speed to the scalable bus clock speed is referred to as bus ratio. For example, one bus cycle for a 100 MHz bus is equal to 15 processor cycles on a 1.50 GHz processor. Since the speed of the bus is implementation-dependent, consult the specifications of a given system for further details.

Data Prefetch

The Pentium 4 processor has two mechanisms for prefetching data: a software controlled prefetch and an automatic hardware prefetch.

Software controlled prefetch is enabled using the four prefetch instructions (PREFETCHh) introduced with SSE. The software-controlled prefetch is not intended for prefetching code. Using it can incur significant penalties on a multiprocessor system if code is shared.

Software controlled data prefetch can provide benefits in selected situations. These situations include:

- when the pattern of memory access operations in software allows the programmer to hide memory latency
- when a reasonable choice can be made about how many cache lines to fetch ahead of the line being execute
- when an choice can be made about the type of prefetch to use

SSE prefetch instructions have different behaviors, depending on cache levels updated and the processor implementation. For instance, a processor may implement the non-temporal prefetch by returning data to the cache level closest to the processor core. This approach has the following effect:

- minimizes disturbance of temporal data in other cache levels
- avoids the need to access off-chip caches, which can increase the realized bandwidth compared to a normal load-miss, which returns data to all cache levels

Situations that are less likely to benefit from software controlled data prefetch are:

- for cases that are already bandwidth bound, prefetching tends to increase bandwidth demands
- prefetching far ahead can cause eviction of cached data from the caches prior to the data being used in execution
- not prefetching far enough can reduce the ability to overlap memory and execution latencies

Software prefetches consume resources in the processor and the use of too many prefetches can limit their effectiveness. Examples of this include prefetching data in a loop for a reference outside the loop and prefetching in a basic block that is frequently executed, but which seldom precedes the reference for which the prefetch is targeted.

See also: Chapter 6, “Optimizing Cache Usage”.

Automatic hardware prefetch is a feature in the Pentium 4 processor. It brings cache lines into the unified second-level cache based on prior reference patterns. See also: Chapter 6, “Optimizing Cache Usage”.

Pros and Cons of Software and Hardware Prefetching. Software prefetching has the following characteristics:

- handles irregular access patterns, which would not trigger the hardware prefetcher
- handles prefetching of short arrays and avoids hardware prefetching start-up delay before initiating the fetches
- must be added to new code; so it does not benefit existing applications

Hardware prefetching for Pentium 4 processor has the following characteristics:

- works with existing applications
- does not require extensive study of prefetch instructions
- requires regular access patterns

- avoids instruction and issue port bandwidth overhead
- has a start-up penalty before the hardware prefetcher triggers and begins initiating fetches

The hardware prefetcher can handle multiple streams in either the forward or backward directions. The start-up delay and fetch-ahead has a larger effect for short arrays when hardware prefetching generates a request for data beyond the end of an array (not actually utilized). The hardware penalty diminishes if it is amortized over longer arrays.

Loads and Stores

The Pentium 4 processor employs the following techniques to speed up the execution of memory operations:

- speculative execution of loads
- reordering of loads with respect to loads and stores
- multiple outstanding misses
- buffering of writes
- forwarding of data from stores to dependent loads

Performance may be enhanced by not exceeding the memory issue bandwidth and buffer resources provided by the processor. Up to one load and one store may be issued for each cycle from a memory port reservation station. In order to be dispatched to a reservation station, there must be a buffer entry available for each memory operation. There are 48 load buffers and 24 store buffers. These buffers hold the μ op and address information until the operation is completed, retired, and deallocated.

The Pentium 4 processor is designed to enable the execution of memory operations out of order with respect to other instructions and with respect to each other. Loads can be carried out speculatively, that is, before all preceding branches are resolved. However, speculative loads cannot cause page faults.

Reordering loads with respect to each other can prevent a load miss from stalling later loads. Reordering loads with respect to other loads and stores to different addresses can enable more parallelism, allowing the machine to execute operations as soon as their inputs are ready. Writes to memory are always carried out in program order to maintain program correctness.

A cache miss for a load does not prevent other loads from issuing and completing. The Pentium 4 processor supports up to four outstanding load misses that can be serviced either by on-chip caches or by memory.

Store buffers improve performance by allowing the processor to continue executing instructions without having to wait until a write to memory and/or cache is complete. Writes are generally not on the critical path for dependence chains, so it is often beneficial to delay writes for more efficient use of memory-access bus cycles.

Store Forwarding

Loads can be moved before stores that occurred earlier in the program if they are not predicted to load from the same linear address. If they do read from the same linear address, they have to wait for the store data to become available. However, with store forwarding, they do not have to wait for the store to write to the memory hierarchy and retire. The data from the store can be forwarded directly to the load, as long as the following conditions are met:

- **Sequence:** the data to be forwarded to the load has been generated by a programmatically-earlier store which has already executed
- **Size:** the bytes loaded must be a subset of (including a proper subset, that is, the same) bytes stored
- **Alignment:** the store cannot wrap around a cache line boundary, and the linear address of the load must be the same as that of the store

Intel® Pentium® M Processor Microarchitecture

Like the Intel NetBurst microarchitecture, the pipeline of the Intel Pentium M processor microarchitecture contains three sections:

- in-order issue front end
- out-of-order superscalar execution core
- in-order retirement unit

Intel Pentium M processor microarchitecture supports a high-speed system bus with 64-byte line size. Most coding recommendations that apply to the Intel NetBurst microarchitecture also apply to the Intel Pentium M processor.

The Intel Pentium M processor microarchitecture is designed for lower power consumption. There are other specific areas of the Pentium M processor microarchitecture that differ from the Intel NetBurst microarchitecture. They are described next. A block diagram of the Intel Pentium M processor is shown in Figure 1-5.

Figure 1-5 The Intel Pentium M Processor Microarchitecture

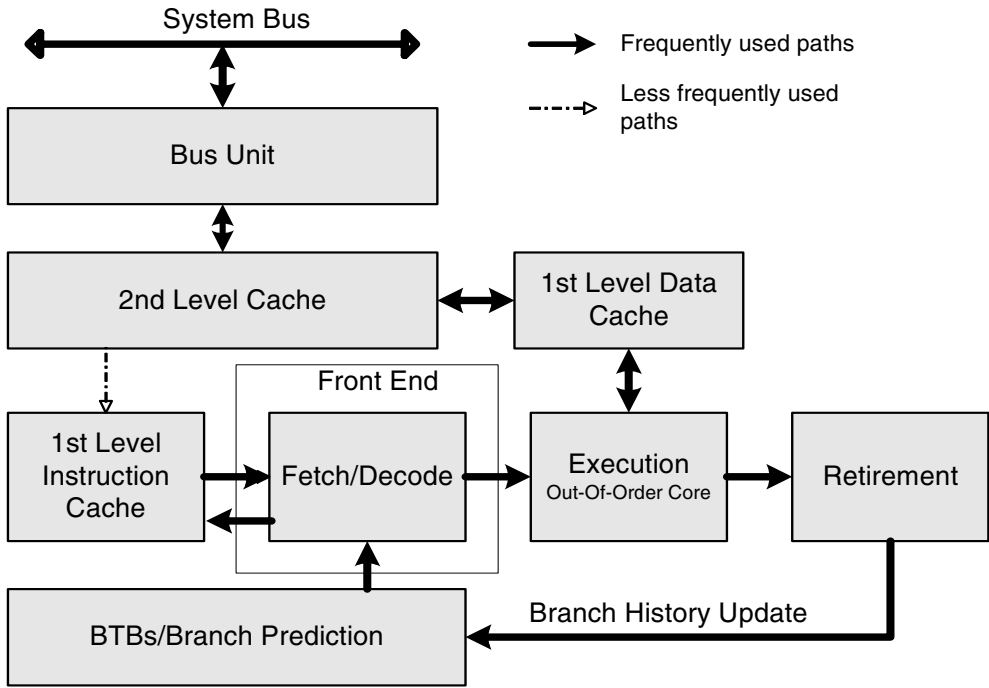

The Front End

The Intel Pentium M processor uses a pipeline depth that enables high performance and low power consumption. It's shorter than that of the Intel NetBurst microarchitecture.

The Intel Pentium M processor front end consists of two parts:

- fetch/decode unit
- instruction cache

The fetch and decode unit includes a hardware instruction prefetcher and three decoders that enable parallelism. It also provides a 32KB instruction cache that stores pre-decoded instructions.

The instruction prefetcher fetches instructions in a linear fashion from memory if the target instructions are not already in the instruction cache. The prefetcher is designed to fetch efficiently from an aligned 16-byte block. If the modulo 16 remainder of a branch target address is 14, only two useful instruction bytes are fetched in the first cycle. The rest of the instruction bytes are fetched in subsequent cycles.

The three decoders decode IA-32 instructions and break them down into micro-ops (μ ops). In each clock cycle, the first decoder is capable of decoding an instruction with four or fewer μ ops. The remaining two decoders each decode a one μ op instruction in each clock cycle.

The front end can issue multiple μ ops per cycle, in original program order, to the out-of-order core.

The Intel Pentium M processor incorporates sophisticated branch prediction hardware to support the out-of-order core. The branch prediction hardware includes static prediction, dynamic prediction, and branch target buffers. The static prediction works is the same as that found in the Intel NetBurst microarchitecture.

The Intel Pentium M processor has enhanced dynamic branch prediction hardware. Branch target buffers (BTB) predict the direction and target of branches based on an instruction's address.

The Pentium M Processor includes two techniques to reduce the execution time of certain operations:

- **ESP Folding.** This eliminates the ESP manipulation micro-operations in stack-related instructions such as PUSH, POP, CALL and RET. It increases decode rename and retirement throughput. ESP folding also increases execution bandwidth by eliminating μ ops which would have required execution resources.
- **Micro-ops (μ ops) fusion.** Some of the most frequent pairs of μ ops derived from the same instruction can be fused into a single μ ops. The following categories of fused μ ops have been implemented in the Pentium M processor:
 - “Store address” and “store data” micro-ops are fused into a single “Store” micro-op. This holds for all types of store operations, including integer, floating-point, MMX technology, and Streaming SIMD Extensions (SSE and SSE2) operations.
 - A load micro-op in most cases can be fused with a successive execution micro-op. This holds for integer, floating-point and MMX technology loads and for most kinds of successive execution operations. Note that SSE Loads can not be fused.

Data Prefetching

The Intel Pentium M processor supports three prefetching mechanisms:

- The first mechanism is a hardware instruction fetcher and is described in the previous section.
- The second mechanism automatically fetches data into the second-level cache.
- The third mechanism is a software-controlled mechanism that fetches data into the caches using the prefetch instructions.

Data is fetched 64 bytes at a time; the instruction and data translation lookaside buffers support 128 entries. See Table 1-2 for processor cache parameters.

Table 1-2 The Pentium M Processor Cache Parameters

Level	Capacity	Associativity (ways)	Line Size (bytes)	Access Latency (clocks)	Write Update Policy
First	32 KB	8	64	3	Writeback
Instruction	32 KB	8	N/A	N/A	N/A
Second	1MB	8	64	9	Writeback

Out-of-Order Core

The processor core dynamically executes μ ops independent of program order. The core is designed to facilitate parallel execution by employing many buffers, issue ports, and parallel execution units.

The out-of-order core buffers μ ops in a Reservation Station (RS) until their operands are ready and resources are available. Each cycle, the core may dispatch up to five μ ops through the issue ports.

In-Order Retirement

The retirement unit in the Pentium M processor buffers completed μ ops is the reorder buffer (ROB). The ROB updates the architectural state in order. Up to three μ ops may be retired per cycle.

Hyper-Threading Technology

Intel Hyper-Threading (HT) Technology is supported in the Intel Xeon processor family and Intel Pentium 4 processor with Hyper-Threading Technology. The technology enables software to take advantage of task-level, or thread-level parallelism by providing multiple logical processors within a physical processor package. In its first implementation in Intel Xeon processor, Hyper-Threading Technology makes a single physical processor appear as two logical processors.

The two logical processors each have a complete set of architectural registers while sharing one single physical processor's resources. By maintaining the architecture state of two processors, an HT Technology capable processor looks like two processors to software, including operating system and application code.

By sharing resources needed for peak demands between two logical processors, HT Technology is well suited for multiprocessor systems to provide an additional performance boost in throughput when compared to traditional MP systems.

Figure 1-6 shows a typical bus-based symmetric multiprocessor (SMP) based on processors with HT Technology. Each logical processor can execute a software thread, allowing a maximum of two software threads to execute simultaneously on one physical processor. The two software threads execute simultaneously, meaning that in the same clock cycle an "add" operation from logical processor 0 and another "add" operation and load from logical processor 1 can be executed simultaneously by the execution engine.

In the first implementation of HT Technology, the physical execution resources are shared and the architecture state is duplicated for each logical processor. This minimizes the die area cost of implementing HT Technology while still achieving performance gains for multithreaded applications or multitasking workloads.

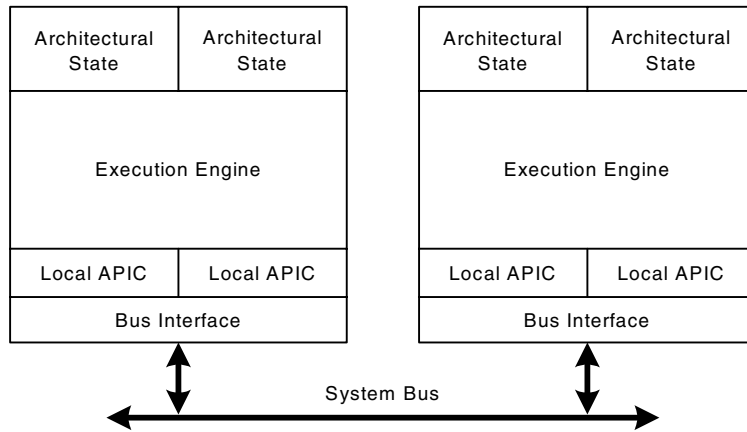
Figure 1-6 Hyper-Threading Technology on an SMP

OM15152

The performance potential due to HT Technology is due to:

- the fact that operating systems and user programs can schedule processes or threads to execute simultaneously on the logical processors in each physical processor
- the ability to use on-chip execution resources at a higher level than when only a single thread is consuming the execution resources; higher level of resource utilization can lead to higher system throughput

Processor Resources and Hyper-Threading Technology

The majority of microarchitecture resources in a physical processor are shared between the logical processors. Only a few small data structures were replicated for each logical processor. This section describes how resources are shared, partitioned or replicated.

Replicated Resources

The architectural state is replicated for each logical processor. The architecture state consists of registers that are used by the operating system and application code to control program behavior and store data for computations. This state includes the eight general-purpose registers, the control registers, machine state registers, debug registers, and others. There are a few exceptions, most notably the memory type range registers (MTRRs) and the performance monitoring resources. For a complete list of the architecture state and exceptions, see the *IA-32 Intel Architecture System Programming Guide*.

Other resources such as instruction pointers and register renaming tables were replicated to simultaneously track execution and state changes of the two logical processors. The return stack predictor is replicated to improve branch prediction of return instructions.

In addition, a few buffers (for example, the 2-entry instruction streaming buffers) were replicated to reduce complexity.

Partitioned Resources

Several buffers are shared by limiting the use of each logical processor to half the entries. These are referred to as partitioned resources.

Reasons for this partitioning include:

- operational fairness
- permitting the ability to allow operations from one logical processor to bypass operations of the other logical processor that may have stalled

For example: a cache miss, a branch misprediction, or instruction dependencies may prevent a logical processor from making forward progress for some number of cycles. The partitioning prevents the stalled logical processor from blocking forward progress.

In general, the buffers for staging instructions between major pipe stages are partitioned. These buffers include μ op queues after the execution trace cache, the queues after the register rename stage, the reorder buffer which stages instructions for retirement, and the load and store buffers.

In the case of load and store buffers, partitioning also provided an easier implementation to maintain memory ordering for each logical processor and detect memory ordering violations.

Shared Resources

Most resources in a physical processor are fully shared to improve the dynamic utilization of the resource, including caches and all the execution units. Some shared resources which are linearly addressed, like the DTLB, include a logical processor ID bit to distinguish whether the entry belongs to one logical processor or the other.

The other resources are fully shared.

Microarchitecture Pipeline and Hyper-Threading Technology

This section describes the HT Technology microarchitecture and how instructions from the two logical processors are handled between the front end and the back end of the pipeline.

Although instructions originating from two programs or two threads execute simultaneously and not necessarily in program order in the execution core and memory hierarchy, the front end and back end contain several selection points to select between instructions from the two logical processors. All selection points alternate between the two logical processors unless one logical processor cannot make use of a pipeline stage. In this case, the other logical processor has full use of every cycle of the pipeline stage. Reasons why a logical processor may not use a pipeline stage include cache misses, branch mispredictions, and instruction dependencies.

Front End Pipeline

The execution trace cache is shared between two logical processors. Execution trace cache access is arbitrated by the two logical processors every clock. If a cache line is fetched for one logical processor in one clock cycle, the next clock cycle a line would be fetched for the other logical processor provided that both logical processors are requesting access to the trace cache.

If one logical processor is stalled or is unable to use the execution trace cache, the other logical processor can use the full bandwidth of the trace cache until the initial logical processor's instruction fetches return from the L2 cache.

After fetching the instructions and building traces of μ ops, the μ ops are placed in a queue. This queue decouples the execution trace cache from the register rename pipeline stage. As described earlier, if both logical processors are active, the queue is partitioned so that both logical processors can make independent forward progress.

Execution Core

The core can dispatch up to six μ ops per cycle, provided the μ ops are ready to execute. Once the μ ops are placed in the queues waiting for execution, there is no distinction between instructions from the two logical processors. The execution core and memory hierarchy is also oblivious to which instructions belong to which logical processor.

After execution, instructions are placed in the re-order buffer. The re-order buffer decouples the execution stage from the retirement stage. The re-order buffer is partitioned such that each uses half the entries.

Retirement

The retirement logic tracks when instructions from the two logical processors are ready to be retired. It retires the instruction in program order for each logical processor by alternating between the two logical

processors. If one logical processor is not ready to retire any instructions, then all retirement bandwidth is dedicated to the other logical processor.

Once stores have retired, the processor needs to write the store data into the level-one data cache. Selection logic alternates between the two logical processors to commit store data to the cache.

General Optimization Guidelines

2

This chapter discusses general optimization techniques that can improve the performance of applications running on the Intel Pentium 4, Intel Xeon and Pentium M processors. These techniques take advantage of the features of the current generation of IA-32 processor family described in Chapter 1.

This chapter explains the optimization techniques both for those who use the Intel® C++ or Fortran Compiler and for those who use other compilers. The Intel® compiler, which generates code specifically tuned for IA-32 processor family, provides the most of the optimization. For those not using the Intel C++ or Fortran Compiler, the assembly code tuning optimizations may be useful. The explanations are supported by coding examples.

Tuning to Achieve Optimum Performance

The most important factors in achieving optimum processor performance are:

- good branch prediction
- avoiding memory access stalls
- good floating-point performance
- instruction selection, including use of SIMD instructions
- instruction scheduling (to maximize trace cache bandwidth)
- vectorization

The following sections describe practices, tools, coding rules and recommendations associated with these factors that will aid in optimizing the performance on IA-32 processors.

Tuning to Prevent Known Coding Pitfalls

To produce program code that takes advantage of the Intel NetBurst microarchitecture and the Pentium M processor microarchitecture, you must avoid the coding pitfalls that limit the performance of the target processor family. This section lists several known pitfalls that can limit performance of Pentium 4 and Intel Xeon processor implementations. Some of these pitfalls, to a lesser degree, also negatively impact Pentium M processor performance (store-to-load-forwarding restrictions, cache-line splits).

Table 2-1 lists coding pitfalls that cause performance degradation in some Pentium 4 and Intel Xeon processor implementations. For every issue, Table 2-1 references a section in this document. The section describes in detail the causes of the penalty and presents a recommended solution. Note that “aligned” here means that the address of the load is aligned with respect to the address of the store.

Table 2-1 Coding Pitfalls Affecting Performance

Factors Affecting Performance	Symptom	Example (if applicable)	Section Reference
Small, unaligned load after large store	Store-forwarding blocked	Example 2-12	Store Forwarding, Store-to-Load-Forwarding Restriction on Size and Alignment
Large load after small store; Load dword after store dword, store byte; Load dword, AND with 0xff after store byte	Store-forwarding blocked	Example 2-13, Example 2-14	Store Forwarding, Store-to-Load-Forwarding Restriction on Size and Alignment

continued

Table 2-1 Coding Pitfalls Affecting Performance (continued)

Factors Affecting Performance	Symptom	Example (if applicable)	Section Reference
Cache line splits	Access across cache line boundary	Example 2-11	Align data on natural operand size address boundaries. If the data will be accesses with vector instruction loads and stores, align the data on 16 byte boundaries.
Denormal inputs and outputs	Slows x87, SSE*, SSE2** floating-point operations		Floating-point Exceptions
Cycling more than 2 values of Floating-point Control Word	<code>fldcw</code> not optimized		Floating-point Modes

* Streaming SIMD Extensions (SSE)

** Streaming SIMD Extensions 2 (SSE2)

General Practices and Coding Guidelines

This section discusses guidelines derived from the performance factors listed in the “Tuning to Achieve Optimum Performance” section. It also highlights practices that use performance tools.

The majority of these guidelines benefit processors based on the Intel NetBurst microarchitecture and the Pentium M processor microarchitecture. Some guidelines benefit one microarchitecture more than the other. As a whole, these coding rules enable software to be optimized for the common performance features of the Intel NetBurst microarchitecture and the Pentium M processor microarchitecture.

The coding practices recommended under each heading and the bullets under each heading are listed in order of importance.

Use Available Performance Tools

- Current-generation compiler, such as the Intel C++ Compiler:
 - Set this compiler to produce code for the target processor implementation
 - Use the compiler switches for optimization and/or profile-guided optimization. These features are summarized in the “Intel® C++ Compiler” section. For more detail, see the *Intel C++ Compiler User’s Guide*.
- Current-generation performance monitoring tools, such as VTune™ Performance Analyzer:
 - Identify performance issues, use event-based sampling, code coach and other analysis resource
 - Characterize the performance gain.

Optimize Performance Across Processor Generations

- Use a `cpuid` dispatch strategy to deliver optimum performance for all processor generations.
- Use compatible code strategy to deliver optimum performance for the current generation of IA-32 processor family and future IA-32 processors.

Optimize Branch Predictability

- Improve branch predictability and optimize instruction prefetching by arranging code to be consistent with the static branch prediction assumption: backward taken and forward not taken.
- Avoid mixing near calls, far calls and returns.
- Avoid implementing a call by pushing the return address and jumping to the target. The hardware can pair up call and return instructions to enhance predictability.
- Use the `pause` instruction in spin-wait loops.

- Inline functions according to coding recommendations.
- Whenever possible, eliminate branches.
- Avoid indirect calls.

Optimize Memory Access

- Observe store-forwarding constraints.
- Ensure proper data alignment to prevent data split across cache line boundary. This includes stack and passing parameters.
- Avoid mixing code and data (self-modifying code).
- Choose data types carefully (see next bullet below) and avoid type casting.
- Employ data structure layout optimization to ensure efficient use of 64-byte cache line size.
- Use prefetching appropriately.
- Minimize use of global variables and pointers.
- Use the `const` modifier; use the `static` modifier for global variables.
- Use the following techniques to enhance locality: blocking, loop interchange, loop skewing.
- Use new cacheability instructions and memory-ordering behavior.

Optimize Floating-point Performance

- Avoid exceeding representable ranges during computation, since handling these cases can have a performance impact. Do not use a larger precision format (double-extended floating point) unless required, since this increases memory size and bandwidth utilization.
- Use the optimized `fldcw` when possible; avoid changing floating-point control/status registers (rounding modes) between more than two values.

- Use efficient conversions, such as those that implicitly include a rounding mode, in order to avoid changing control/status registers.
- Take advantage of the SIMD capabilities of Streaming SIMD Extensions (SSE) and of Streaming SIMD Extensions 2 (SSE2) instructions. Enable flush-to-zero mode and DAZ mode when using SSE and SSE2 instructions.
- Avoid denormalized input values, denormalized output values, and explicit constants that could cause denormal exceptions.
- Avoid excessive use of the `fxch` instruction.

Optimize Instruction Selection

- Avoid longer latency instructions: shifts, integer multiplies and divides. Replace them with alternate code sequences (e.g. adds instead of shifts, and shifts instead of multiplies).
- Use the `leaq` instruction and the full range of addressing modes to do address calculation.
- Some types of stores use more μ ops than others, try to use simpler store variants and/or reduce the number of stores.
- Avoid use of complex instructions that require more than 4 μ ops.
- Avoid instructions that unnecessarily introduce dependence-related stalls: `inc` and `dec` instructions, partial register operations (8/16-bit operands).
- Avoid use of `ah`, `bh`, and other higher 8-bits of the 16-bit registers, because accessing them requires a shift operation internally.
- Use `xor` and `pxor` instructions to clear registers and break dependencies.
- Use efficient approaches for performing comparisons.

Optimize Instruction Scheduling

- Consider latencies and resource constraints.
- Calculate store addresses as early as possible.
- Arrange load operations and store operations using the same address such that the load does not follow the store immediately, especially if the store depends on a long-latency operation.

Enable Vectorization

- Use the smallest possible data type. This enables more parallelism with the use of a longer vector.
- Arrange the nesting of loops so the innermost nesting level is free of inter-iteration dependencies. It is especially important to avoid the case where the store of data in an earlier iteration happens lexically after the load of that data in a future iteration (called lexically-backward dependence).
- Avoid the use of conditionals.
- Keep induction (loop) variable expressions simple.
- Avoid using pointers, try to replace pointers with arrays and indices.

Coding Rules, Suggestions and Tuning Hints

This chapter includes rules, suggestions and hints. They are maintained in separately-numbered lists and are targeted for engineers who are:

- modifying the source to enhance performance (user/source rules)
- writing assembly or compilers (assembly/compiler rules)
- doing detailed performance tuning (tuning suggestions)

Coding recommendations are ranked in importance using two measures:

- Local impact (referred to as “impact”) is the difference that a recommendation makes to performance for a given instance, with the impact’s priority marked as: H = high, M = medium, L = low.

- Generality measures how frequently such instances occur across all application domains, with the frequency marked as: H = high, M = medium, L = low.

These rules are very approximate. They can vary depending on coding style, application domain, and other factors. The purpose of including high, medium and low priorities with each recommendation is to provide some hints as to the degree of performance gain that one can expect if a recommendation is implemented.

Because it is not possible to predict the frequency of occurrence of a code instance in applications, priority hints cannot be directly correlated to application-level performance gain. However, in important cases where application-level performance gain has been observed, a more quantitative characterization of application-level performance gain is provided for information only (see: “Store-to-Load-Forwarding Restriction on Size and Alignment” and “Instruction Selection” in this document). In places where no priority is assigned, the impact has been deemed inapplicable.

Performance Tools

Intel offers several tools that can facilitate optimizing your application’s performance.

Intel® C++ Compiler

Use the Intel C++ Compiler following the recommendations described here. The Intel Compiler’s advanced optimization features provide good performance without the need to hand-tune assembly code. However, the following features may enhance performance even further:

- Inlined assembly

- Intrinsic, which have a one-to-one correspondence with assembly language instructions but allow the compiler to perform register allocation and instruction scheduling. Refer to the “Intel C++ Intrinsic Reference” section of the *Intel C++ Compiler User’s Guide*.
- C++ class libraries. Refer to the “Intel C++ Class Libraries for SIMD Operations Reference” section of the *Intel C++ Compiler User’s Guide*.
- Vectorization in conjunction with compiler directives (pragmas). Refer to the “Compiler Vectorization Support and Guidelines” section of the *Intel C++ Compiler User’s Guide*.

The Intel C++ Compiler can generate an executable which uses features such as Streaming SIMD Extensions 2. The executable will maximize performance on the current generation of IA-32 processor family (for example, a Pentium 4 processor) and still execute correctly on older processors. Refer to the “Processor Dispatch Support” section in the *Intel C++ Compiler User’s Guide*.

General Compiler Recommendations

A compiler that has been extensively tuned for the target microarchitecture can be expected to match or outperform hand-coding in a general case. However, if particular performance problems are noted with the compiled code, some compilers (like the Intel C++ and Fortran Compilers) allow the coder to insert intrinsics or inline assembly in order to exert greater control over what code is generated. If inline assembly is used, the user should verify that the code generated to integrate the inline assembly is of good quality and yields good overall performance.

Default compiler switches are targeted for the common case. An optimization may be made to the compiler default if it is beneficial for most programs. If a performance problem is root-caused to a poor choice on the part of the compiler, using different switches or compiling the targeted module with a different compiler may be the solution.

VTune™ Performance Analyzer

Where performance is a critical concern, use performance monitoring hardware and software tools to tune your application and its interaction with the hardware. IA-32 processors have counters which can be used to monitor a large number of performance-related events for each microarchitecture. The counters also provide information that helps resolve the coding pitfalls.

The VTune Performance Analyzer uses these counters to provide with two kinds of feedback:

- indication of a performance improvement gained by using a specific coding recommendation or microarchitectural feature
- information on whether a change in the program has improved or degraded performance with respect to a particular metric

Note that improving performance in one part of the machine does not necessarily bring significant gains to overall performance. It is possible to degrade overall performance by improving performance for some particular metric.

Where appropriate, coding recommendations in this chapter include descriptions of the VTune analyzer events that provide measurable data of performance gain achieved by following recommendations. Refer to the VTune analyzer online help for instructions on how to use the tool.

The VTune analyzer events include a number of Pentium 4 processor performance metrics described in Appendix B, “Intel Pentium 4 Processor Performance Metrics”.

Processor Perspectives

The majority of the coding recommendations for the Pentium 4 and Intel Xeon processors also apply to Pentium M processors. However,

there are situations where a recommendation may benefit one microarchitecture more than the other. The most important of these are:

- Instruction decode throughput is important for the Pentium M processor but less important for the Pentium 4 and Intel Xeon processors. Generating code with the 4-1-1 template (instruction with four `μops` followed by two instructions with one `μop` each) helps the Pentium M processor. The practice has no real impact on processors based on the Intel NetBurst microarchitecture.
- Dependencies for partial register writes incur large penalties when using the Pentium M processor. On Pentium 4 and Intel Xeon processors, such penalties are resolved by artificial dependencies between each partial register write. To avoid false dependences from partial register updates, use full register updates and extended moves.
- On Pentium 4 and Intel Xeon processors, some latencies have increased: shifts, rotates, integer multiplies, and moves from memory with sign extension are longer than before. Use care when using the `leaq` instruction. See the section “Use of the `leaq` Instruction” for recommendations.
- The `inc` and `dec` instructions should always be avoided. Using `add` and `sub` instructions instead avoids data dependence and improves performance.
- Dependence-breaking support is added for the `pxor` instruction.
- Floating point register stack exchange instructions were free; now they are slightly more expensive due to issue restrictions.
- Writes and reads to the same location should now be spaced apart. This is especially true for writes that depend on long-latency instructions.
- Hardware prefetching may shorten the effective memory latency for data and instruction accesses.
- Cacheability instructions are available to streamline stores and manage cache utilization.

- Cache lines are 64 bytes (see Table 1-1 and Table 1-2). Because of this, software prefetching should be done less often. False sharing, however, can be an issue.
- On the Pentium 4 and Intel Xeon processors, the primary code size limit of interest is imposed by the trace cache. On Pentium M processors, code size limit is governed by the instruction cache.
- There may be a penalty when instructions with immediates requiring more than 16-bit signed representation are placed next to other instructions that use immediates.

Note that memory-related optimization techniques for alignments, complying with store-to-load-forwarding restrictions and avoiding data splits help Pentium 4 processors as well as Pentium M processors.

CPUID Dispatch Strategy and Compatible Code Strategy

Where optimum performance on all processor generations is desired, applications can take advantage of `cpuid` to identify the processor generation and integrate processor-specific instructions (such as SSE2 instructions) into the source code. The Intel C++ Compiler supports the integration of different versions of the code for different target processors. The selection of which code to execute at runtime is made based on the CPU identifier that is read with `cpuid`. Binary code targeted for different processor generations can be generated under the control of the programmer or by the compiler.

For applications run on both the Intel Pentium 4 and Pentium M processors, and where minimum binary code size and single code path is important, a compatible code strategy is the best. Optimizing applications for the Intel NetBurst microarchitecture is likely to improve code efficiency and scalability when running on processors based on current and future generations of IA-32 processors. This approach to optimization is also likely to deliver high performance on Pentium M processors.

Branch Prediction

Branch optimizations have a significant impact on performance. By understanding the flow of branches and improving the predictability of branches, you can increase the speed of code significantly.

Optimizations that help branch prediction are:

- Keep code and data on separate pages (a very important item, see more details in the “Memory Accesses” section).
- Whenever possible, eliminate branches.
- Arrange code to be consistent with the static branch prediction algorithm.
- If it is not possible to arrange code, use branch direction hints where appropriate.
- Use the `pause` instruction in spin-wait loops.
- Inline functions and pair up calls and returns.
- Unroll as necessary so that repeatedly-executed loops have sixteen or fewer iterations, unless this causes an excessive code size increase.
- Separate branches so that they occur no more frequently than every three μ ops where possible.

Eliminating Branches

Eliminating branches improves performance because it:

- reduces the possibility of mispredictions
- reduces the number of required branch target buffer (BTB) entries; conditional branches, which are never taken, do not consume BTB resources

There are four principal ways of eliminating branches:

- arrange code to make basic blocks contiguous
- unroll loops, as discussed in the “Loop Unrolling” section

- use the `cmov` instruction
- use the `setcc` instruction

Assembly/Compiler Coding Rule 1. (MH impact, H generality) *Arrange code to make basic blocks contiguous and eliminate unnecessary branches.*

For the Pentium M processor, every branch counts, even correctly predicted branches have a negative effect on the amount of useful code delivered to the processor. Also, taken branches consume space in the branch prediction structures and extra branches create pressure on the capacity of the structures.

Assembly/Compiler Coding Rule 2. (M impact, ML generality) *Use the `setcc` and `cmov` instructions to eliminate unpredictable conditional branches where possible. Do not do this for predictable branches. Do not use these instructions to eliminate all unpredictable conditional branches, because using these instructions will incur execution overhead due to executing both paths of a conditional branch. In addition, converting conditional branches to `cmovs` or `setcc` trades of control flow dependence for data dependence and restricts the capability of the out of order engine. When tuning, note that all IA-32 based processors have very high branch prediction rates. Consistently mispredicted are rare. Use these instructions only if the increase in computation time is less than the expected cost of a mispredicted branch.*

Consider a line of C code that has a condition dependent upon one of the constants:

```
X = (A < B) ? CONST1 : CONST2;
```

This code conditionally compares two values, A and B. If the condition is true, X is set to `CONST1`; otherwise it is set to `CONST2`. An assembly code sequence equivalent to the above C code can contain branches that are not predictable if there are no correlation in the two values.

Example 2-1 shows the assembly code with unpredictable branches. The unpredictable branches in Example 2-1 can be removed with the use of the `setcc` instruction. Example 2-2 shows an optimized code that does not have branches.

Example 2-1 Assembly Code with an Unpredictable Branch

```

    cmp    A, B           ; condition
    jge    L30            ; conditional branch
    mov    ebx, CONST1   ; ebx holds X
    jmp    L31            ; unconditional branch

L30:
    mov    ebx, CONST2

L31:

```

Example 2-2 Code Optimization to Eliminate Branches

```

xor    ebx, ebx         ; clear ebx (X in the C code)
cmp    A, B
setge bl                ; When ebx = 0 or 1
                        ; OR the complement condition

sub    ebx, 1           ; ebx=11...11 or 00...00
and    ebx, CONST3     ; CONST3 = CONST1-CONST2
add    ebx, CONST2     ; ebx=CONST1 or CONST2

```

See Example 2-2. The optimized code sets `ebx` to zero, then compares `A` and `B`. If `A` is greater than or equal to `B`, `ebx` is set to one. Then `ebx` is decreased and “and-ed” with the difference of the constant values. This sets `ebx` to either zero or the difference of the values. By adding `CONST2` back to `ebx`, the correct value is written to `ebx`. When `CONST2` is equal to zero, the last instruction can be deleted.

Another way to remove branches on Pentium II and subsequent processors is to use the `cmov` and `fcmov` instructions. Example 2-3 shows changing a `test` and branch instruction sequence using `cmov` and

eliminating a branch. If the `test` sets the equal flag, the value in `ebx` will be moved to `eax`. This branch is data-dependent, and is representative of an unpredictable branch.

Example 2-3 Eliminating Branch with CMOV Instruction

```
test ecx, ecx
jne 1h
mov  eax, ebx

1h:
; To optimize code, combine jne and mov into one cmovcc
; instruction that checks the equal flag
test     ecx, ecx      ; test the flags
cmovcq  eax, ebx      ; if the equal flag is set, move
                                     ; ebx to eax - the 1h: tag no longer
                                     ; needed
```

The `cmov` and `fcmov` instructions are available on the Pentium II and subsequent processors, but not on Pentium processors and earlier 32-bit Intel architecture processors. Be sure to check whether a processor supports these instructions with the `cpuid` instruction.

Spin-Wait and Idle Loops

The Pentium 4 processor introduces a new `pause` instruction; the instruction is architecturally a `nop` on all IA-32 implementations. To the Pentium 4 processor, this instruction acts as a hint that the code sequence is a spin-wait loop. Without a `pause` instruction in such loops, the Pentium 4 processor may suffer a severe penalty when exiting the loop because the processor may detect a possible memory order violation. Inserting the `pause` instruction significantly reduces the likelihood of a memory order violation and as a result improves performance.

In Example 2-4, the code spins until memory location A matches the value stored in the register `eax`. Such code sequences are common when protecting a critical section, in producer-consumer sequences, for barriers, or other synchronization.

Example 2-4 Use of `pause` Instruction

```
lock:  cmp  eax, A
        jne  loop
        ; code in critical section:
loop:  pause
        cmp  eax, A
        jne  loop
        jmp  lock
```

Static Prediction

Branches that do not have a history in the BTB (see the “Branch Prediction” section) are predicted using a static prediction algorithm. The Pentium 4, Pentium III and Pentium II processors have the static prediction algorithm that follows:

- Predict unconditional branches to be taken.
- Predict backward conditional branches to be taken. This rule is suitable for loops.
- Predict forward conditional branches to be NOT taken.
- Predict indirect branches to be NOT taken.

Assembly/Compiler Coding Rule 3. (M impact, H generality) *Arrange code to be consistent with the static branch prediction algorithm: make the fall-through code following a conditional branch be the likely target for a branch with a forward target, and make the fall-through code following a conditional branch be the unlikely target for a branch with a backward target.*

Pentium M processors do not predict conditional branches according to the jump direction. All conditional branches are dynamically predicted, even at their first appearance.

Example 2-5 illustrates the static branch prediction algorithm. The body of an `if-then` conditional is predicted to be executed

Example 2-5 Pentium 4 Processor Static Branch Prediction Algorithm

forward conditional branches not taken (fall through)

```
If <condition> {  
...  
}
```

```
for <condition> {  
...  
}
```

Unconditional Branches taken
JMP

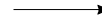

Backward Conditional Branches are taken

```
loop {  
↑  
} <condition>
```

Examples 2-6, Example 2-7 provide basic rules for a static prediction algorithm.

In Example 2-6, the backward branch (`JC Begin`) is not in the BTB the first time through, therefore, the BTB does not issue a prediction. The static predictor, however, will predict the branch to be taken, so a misprediction will not occur.

Example 2-6 Static Taken Prediction Example

```

Begin:  mov     eax, mem32
        and     eax, ebx
        imul   eax, edx
        shld   eax, 7
        jc     Begin

```

The first branch instruction (`JC Begin`) in Example 2-7 segment is a conditional forward branch. It is not in the BTB the first time through, but the static predictor will predict the branch to fall through.

The static prediction algorithm correctly predicts that the `Call Convert` instruction will be taken, even before the branch has any branch history in the BTB.

Example 2-7 Static Not-Taken Prediction Example

```

        mov     eax, mem32
        and     eax, ebx
        imul   eax, edx
        shld   eax, 7
        jc     Begin
        mov     eax, 0
Begin:  call    Convert

```

Inlining, Calls and Returns

The return address stack mechanism augments the static and dynamic predictors to optimize specifically for calls and returns. It holds 16 entries, which is large enough to cover the call depth of most programs. If there is a chain of more than 16 nested calls and more than 16 returns in rapid succession, performance may be degraded.

The trace cache maintains branch prediction information for calls and returns. As long as the trace with the call or return remains in the trace cache and if the call and return targets remain unchanged, the depth limit of the return address stack described above will not impede performance.

To enable the use of the return stack mechanism, calls and returns must be matched in pairs. If this is done, the likelihood of exceeding the stack depth in a manner that will impact performance is very low.

Assembly/Compiler Coding Rule 4. (MH impact, MH generality) *Near calls must be matched with near returns, and far calls must be matched with far returns. Pushing the return address on the stack and jumping to the routine to be called is not recommended since it creates a mismatch in calls and returns.*

Calls and returns are expensive; use inlining for the following reasons:

- Parameter passing overhead can be eliminated.
- In a compiler, inlining a function exposes more opportunity for optimization.
- If the inlined routine contains branches, the additional context of the caller may improve branch prediction within the routine.
- A mispredicted branch can lead to larger performance penalties inside a small function than if that function is inlined.

Assembly/Compiler Coding Rule 5. (MH impact, MH generality) *Selectively inline a function where doing so decreases code size or if the function is small and the call site is frequently executed.*

Assembly/Compiler Coding Rule 6. (H impact, M generality) *Do not inline a function if doing so increases the working set size beyond what will fit in the trace cache.*

Assembly/Compiler Coding Rule 7. (ML impact, ML generality) *If there are more than 16 nested calls and returns in rapid succession; consider transforming the program with inline to reduce the call depth.*

Assembly/Compiler Coding Rule 8. (ML impact, ML generality) *Favor inlining small functions that contain branches with poor prediction rates. If a branch misprediction results in a RETURN being prematurely predicted as taken, a performance penalty may be incurred.*

Assembly/Compiler Coding Rule 9. (L impact, L generality) *If the last statement in a function is a call to another function, consider converting the call to a jump. This will save the call/ return overhead as well as an entry in the return stack buffer.*

Assembly/Compiler Coding Rule 10. (M impact, L generality) *Do not put more than four branches in a 16-byte chunk.*

Assembly/Compiler Coding Rule 11. (M impact, L generality) *Do not put more than two end loop branches in a 16-byte chunk.*

Branch Type Selection

Counting loops can have a test and conditional branch at the top of the loop body or at the bottom.

Assembly/Compiler Coding Rule 12. (M impact, MH generality) *If the average number of total iterations is less than or equal to 100, use a forward branch to exit the loop.*

The default predicted target for indirect branches and calls is the fall-through path. The fall-through prediction is overridden if and when a hardware prediction is available for that branch. The predicted branch target from branch prediction hardware for an indirect branch is the previously executed branch target.

The default prediction to the fall-through path is only a significant issue if no branch prediction is available, due to poor code locality or pathological branch conflict problems. For indirect calls, predicting the fall-through path is usually not an issue, since execution will likely return to the instruction after the associated return.

Placing data immediately following an indirect branch can cause a performance problem. If the data consist of all zeros, it looks like a long stream of adds to memory destinations, which can cause resource conflicts and slow down branch recovery. Also, the data immediately following indirect branches may appear as branches to the branch predication hardware, which can branch off to execute other data pages. This can lead to subsequent self-modifying code problems.

Assembly/Compiler Coding Rule 13. (M impact, L generality) *When indirect branches are present, try to put the most likely target of an indirect branch immediately following the indirect branch. Alternatively, if indirect branches are common but they cannot be predicted by branch prediction hardware, then follow the indirect branch with a UD2 instruction, which will stop the processor from decoding down the fall-through path.*

Indirect branches resulting from code constructs, such as switch statements, computed GOTOS or calls through pointers, can jump to an arbitrary number of locations. If the code sequence is such that the target destination of a branch goes to the same address most of the time, then the BTB will predict accurately most of the time. Since only one taken (non-fall-through) target can be stored in the BTB, indirect branches with multiple taken targets may have lower prediction rates.

The effective number of targets stored may be increased by introducing additional conditional branches. Adding a conditional branch to a target is fruitful if and only if:

- The branch direction is correlated with the branch history leading up to that branch, that is, not just the last target, but how it got to this branch.

- The source/target pair is common enough to warrant using the extra branch prediction capacity. (This may increase the number of overall branch mispredictions, while improving the misprediction of indirect branches. The profitability is lower if the number of mispredicting branches is very large).

User/Source Coding Rule 1. (M impact, L generality) *If an indirect branch has two or more common taken targets, and at least one of those targets are correlated with branch history leading up to the branch, then convert the indirect branch into a tree where one or more indirect branches are preceded by conditional branches to those targets. Apply this “peeling” procedure to the common target of an indirect branch that correlates to branch history.*

The purpose of this rule is to reduce the total number of mispredictions by enhancing the predictability of branches, even at the expense of adding more branches. The added branches must be very predictable for this to be worthwhile. One reason for such predictability is a strong correlation with preceding branch history, that is, the directions taken on preceding branches are a good indicator of the direction of the branch under consideration.

Example 2-8 shows a simple example of the correlation between a target of a preceding conditional branch with a target of an indirect branch. Correlation can be difficult to determine analytically, either for a compiler or sometimes for an assembly language programmer. It may be fruitful to evaluate performance with and without this peeling, to get the

best performance from a coding effort. An example of peeling out the most favored target of an indirect branch with correlated branch history is shown in Example 2-9.

Example 2-8 Indirect Branch With Two Favored Targets

```
function ()
{
    int n    = rand();    // random integer 0 to RAND_MAX
    if( !(n & 0x01) ){ // n will be 0 half the times
        n = 0;          // updates branch history to predict taken
    }

    // indirect branches with multiple taken targets
    // may have lower prediction rates
    switch (n) {
    case 0: handle_0(); break; // common target, correlated with
                               // branch history that is forward taken
    case 1: handle_1(); break; // uncommon
    case 3: handle_3(); break; // uncommon
    default: handle_other(); // common target
    }
}
```

Example 2-9 A Peeling Technique to Reduce Indirect Branch Misprediction

```
function ()
{
    int n    = rand();           // random integer 0 to RAND_MAX
    if( !(n & 0x01) ) n = 0;
        // n will be 0 half the times
    if (!n) handle_0();         // peel out the most common target
                                // with correlated branch history
    else {
        switch (n) {
            case 1: handle_1(); break; // uncommon
            case 3: handle_3(); break; // uncommon
            default: handle_other(); // make the favored target in
                                    // the fall-through path
        }
    }
}
```

Loop Unrolling

The benefits of unrolling loops are:

- Unrolling amortizes the branch overhead, since it eliminates branches and some of the code to manage induction variables.
- Unrolling allows you to aggressively schedule (or pipeline) the loop to hide latencies. This is useful if you have enough free registers to keep variables live as you stretch out the dependence chain to expose the critical path.
- Unrolling exposes the code to various other optimizations, such as removal of redundant loads, common subexpression elimination, and so on.
- The Pentium 4 processor can correctly predict the exit branch for an inner loop that has 16 or fewer iterations, if that number of iterations is predictable and there are no conditional branches in the loop. Therefore, if the loop body size is not excessive, and the probable

number of iterations is known, unroll inner loops until they have a maximum of 16 iterations. With the Pentium M processor, do not unroll loops more than 64 iterations.

The potential costs of unrolling loops are:

- Excessive unrolling, or unrolling of very large loops can lead to increased code size. This can be harmful if the unrolled loop no longer fits in the trace cache (TC).
- Unrolling loops whose bodies contain branches increases demands on the BTB capacity. If the number of iterations of the unrolled loop is 16 or less, the branch predictor should be able to correctly predict branches in the loop body that alternate direction.

Assembly/Compiler Coding Rule 14. (H impact, M generality) *Unroll small loops until the overhead of the branch and the induction variable accounts, generally, for less than about 10% of the execution time of the loop.*

Assembly/Compiler Coding Rule 15. (H impact, M generality) *Avoid unrolling loops excessively, as this may thrash the trace cache or instruction cache.*

Assembly/Compiler Coding Rule 16. (M impact, M generality) *Unroll loops that are frequently executed and that have a predictable number of iterations to reduce the number of iterations to 16 or fewer, unless this increases code size so that the working set no longer fits in the trace cache or instruction cache. If the loop body contains more than one conditional branch, then unroll so that the number of iterations is 16/(# conditional branches).*

Example 2-10 shows how unrolling enables other optimizations.

Example 2-10 Loop Unrolling

Before unrolling:

```
do i=1,100
  if (i mod 2 == 0) then a(i) = x
  else a(i) = y
enddo
```

After unrolling

```
do i=1,100,2
  a(i) = y
  a(i+1) = x
enddo
```

In this example, a loop that executes 100 times assigns x to every even-numbered element and y to every odd-numbered element. By unrolling the loop you can make both assignments each iteration, removing one branch in the loop body.

Compiler Support for Branch Prediction

Compilers can generate code that improves the efficiency of branch prediction in the Pentium 4 and Pentium M processors. The Intel C++ Compiler accomplishes this by:

- keeping code and data on separate pages
- using conditional move instructions to eliminate branches
- generating code that is consistent with the static branch prediction algorithm
- inlining where appropriate
- unrolling, if the number of iterations is predictable

With profile-guided optimization, the Intel compiler can lay out basic blocks to eliminate branches for the most frequently executed paths of a function or at least improve their predictability. Branch prediction need not be a concern at the source level. For more information, see the *Intel® C++ Compiler User's Guide*.

Memory Accesses

This section discusses guidelines for optimizing code and data memory accesses. The most important recommendations are:

- align data, paying attention to data layout and stack alignment
- enable store forwarding
- place code and data on separate pages
- enhance data locality
- use prefetching and cacheability control instructions
- enhance code locality and align branch targets
- take advantage of write combining

Alignment and forwarding problems are among the most common sources of large delays on the Pentium 4 processor.

Alignment

Alignment of data concerns all kinds of variables:

- dynamically allocated
- members of a data structure
- global or local variables
- parameters passed on the stack

Misaligned data access can incur significant performance penalties. This is particularly true for cache line splits. The size of a cache line is 64 bytes in the Pentium 4, Intel Xeon, and Pentium M processors.

On the Pentium 4 processor, an access to data unaligned on 64-byte boundary leads to two memory accesses and requires several μ ops to be executed (instead of one). Accesses that span either 16-byte or 64-byte boundaries are likely to incur a large performance penalty, since they are executed near retirement, and can incur stalls that are on the order of the depth of the pipeline.

Assembly/Compiler Coding Rule 17. (H impact, H generality) *Align data on natural operand size address boundaries. If the data will be accesses with vector instruction loads and stores, align the data on 16 byte boundaries.*

For best performance, align data as follows:

- Align 8-bit data at any address.
- Align 16-bit data to be contained within an aligned four byte word.
- Align 32-bit data so that its base address is a multiple of four.
- Align 64-bit data so that its base address is a multiple of eight.
- Align 80-bit data so that its base address is a multiple of sixteen.
- Align 128-bit data so that its base address is a multiple of sixteen.

A 64-byte or greater data structure or array should be aligned so that its base address is a multiple of 64. Sorting data in decreasing size order is one heuristic for assisting with natural alignment. As long as 16-byte boundaries (and cache lines) are never crossed, natural alignment is not strictly necessary, though it is an easy way to enforce this.

Example 2-11 shows the type of code that can cause a cache line split. The code loads the addresses of two `dword` arrays. `029e70feh` is not a 4-byte-aligned address, so a 4-byte access at this address will get 2 bytes from the cache line this address is contained in, and 2 bytes from the cache line that starts at `029e7100h`. On processors with 64-byte cache

lines, a similar cache line split will occur every 8 iterations. Figure 2-1 illustrates the situation of accessing a data element that span across cache line boundaries.

Example 2-11 Code That Causes Cache Line Split

```

mov     esi, 029e70feh
mov     edi, 05be5260h
Blockmove:
mov     eax, DWORD PTR [esi]
mov     ebx, DWORD PTR [esi+4]
mov     DWORD PTR [edi], eax
mov     DWORD PTR [edi+4], ebx
add     esi, 8
add     edi, 8
sub     edx, 1
jnz    Blockmove

```

Figure 2-1 Cache Line Split in Accessing Elements in a Array

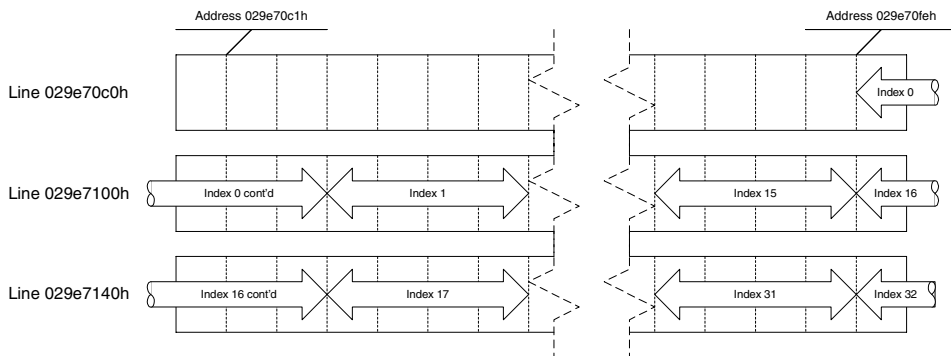

Alignment of code is less of an issue for the Pentium 4 processor. Alignment of branch targets to maximize bandwidth of fetching cached instructions is an issue only when not executing out of the trace cache.

Alignment of code can be an issue for the Pentium M processor, and alignment of branch targets will improve decoder throughput.

Store Forwarding

The processor's memory system only sends stores to memory (including cache) after store retirement. However, store data can be forwarded from a store to a subsequent load from the same address to give a much shorter store-load latency.

There are two kinds of requirements for store forwarding. If these requirements are violated, store forwarding cannot occur and the load must get its data from the cache (so the store must write its data back to the cache first). This incurs a penalty that is related to pipeline depth.

The first requirement pertains to the size and alignment of the store-forwarding data. This restriction is likely to have high impact to overall application performance. Typically, performance penalty due to violating this restriction can be prevented. Several examples of coding pitfalls that cause store-forwarding stalls and solutions to these pitfalls are discussed in detail in the "Store-to-Load-Forwarding Restriction on Size and Alignment" section. The second requirement is the availability of data, discussed in the "Store-forwarding Restriction on Data Availability" section.

A good practice is to eliminate redundant load operations, see some guidelines below.

It may be possible to keep a temporary scalar variable in a register and never write it to memory. Generally, such a variable must not be accessible via indirect pointers. Moving a variable to a register eliminates all loads and stores of that variable and eliminates potential problems associated with store forwarding. However, it also increases register pressure.

Load instructions tend to start chains of computation. Since the out of order engine is based on data dependence, load instructions play a significant role in the engine capability to execute at a high rate. Eliminating loads should be given a high priority.

If a variable is known not to change between when it is stored and when it is used again, the register that was stored can be copied or used directly. If register pressure is too high, or an unseen function is called before the store and the second load, it may not be possible to eliminate the second load.

Assembly/Compiler Coding Rule 18. (H impact, M generality) *Pass parameters in registers instead of on the stack where possible. Passing arguments on the stack is a case of store followed by a reload. While this sequence is optimized in IA-32 processors by providing the value to the load directly from the memory order buffer without the need to access the data cache, floating point values incur a significant latency in forwarding. Passing floating point argument in (preferably XMM) registers should save this long latency operation.*

Parameter passing conventions may limit the choice of which parameters are passed in registers versus on the stack. However, these limitations may be overcome if the compiler has control of the compilation of the whole binary (using whole-program optimization).

Store-to-Load-Forwarding Restriction on Size and Alignment

Data size and alignment restrictions for store-forwarding apply to the Pentium 4, Intel Xeon and Pentium M processor. The performance penalty from violating store-forwarding restrictions is less for Pentium M processors than that for Pentium 4 processors.

This section describes these restrictions in all cases. It prescribes recommendations to prevent the non-forwarding penalty. Fixing this problem for Pentium 4 and Intel Xeon processors also fixes problem on Pentium M processors.

The size and alignment restrictions for store forwarding are illustrated in Figure 2-2.

Figure 2-2 Size and Alignment Restrictions in Store Forwarding

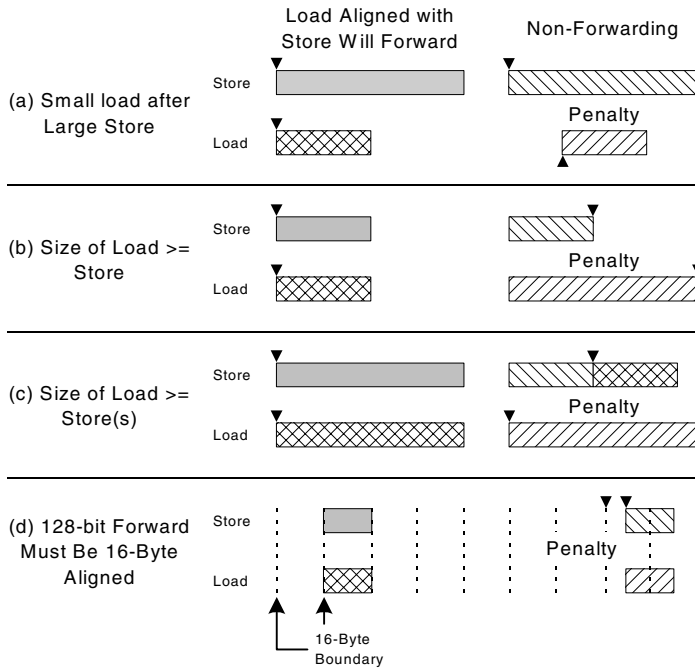

OM15155

Coding rules to help programmers satisfy size and alignment restrictions for store forwarding follow.

Assembly/Compiler Coding Rule 19. (H impact, M generality) *A load that forwards from a store must have the same address start point and therefore the same alignment as the store data.*

Assembly/Compiler Coding Rule 20. (H impact, M generality) *The data of a load which is forwarded from a store must be completely contained within the store data.*

A load that forwards from a store must wait for the store's data to be written to the store buffer before proceeding, but other, unrelated loads need not wait.

Assembly/Compiler Coding Rule 21. (H impact, ML generality) *If it is necessary to extract a non-aligned portion of stored data, read out the smallest aligned portion that completely contains the data and shift/mask the data as necessary.*

This is better than incurring the penalties of a failed store-forward.

Assembly/Compiler Coding Rule 22. (MH impact, ML generality) *Avoid several small loads after large stores to the same area of memory by using a single large read and register copies as needed.*

Example 2-12 contains several store-forwarding situations when small loads follow large stores. The first three load operations illustrate the situations described in Rule 22. However, the last load operation gets data from store-forwarding without problem.

Example 2-12 Several Situations of Small Loads After Large Store

```
mov [EBP], 'abcd'  
mov AL, [EBP]      ; not blocked - same alignment  
mov BL, [EBP + 1] ; blocked  
mov CL, [EBP + 2] ; blocked  
mov DL, [EBP + 3] ; blocked  
mov AL, [EBP]      ; not blocked - same alignment  
                  ; n.b. passes older blocked loads
```

Example 2-13 illustrates a store-forwarding situation when a large load follows after several small stores. The data needed by the load operation cannot be forwarded because all of the data that needs to be forwarded is not contained in the store buffer. Avoid large loads after small stores to the same area of memory.

Example 2-13 A Non-forwarding Example of Large Load After Small Store

```
mov [EBP],      'a'
mov [EBP + 1],  'b'
mov [EBP + 2],  'c'
mov [EBP + 3],  'd'
mov EAX, [EBP]      ; blocked
; The first 4 small store can be consolidated into
; a single DWORD store to prevent this non-forwarding
; situation
```

Example 2-14 illustrates a stalled store-forwarding situation that may appear in compiler generated code. Sometimes a compiler generates code similar to that shown in Example 2-14 to handle spilled byte to the stack and convert the byte to an integer value.

Example 2-14 A Non-forwarding Situation in Compiler Generated Code

```
mov DWORD PTR [esp+10h], 00000000h
mov BYTE PTR [esp+10h], bl
mov eax, DWORD PTR [esp+10h] ; Stall
and eax, 0xff                ; converting back to byte value
```

Example 2-15 offers two alternatives to avoid the non-forwarding situation shown in Example 2-14.

Example 2-15 Two Examples to Avoid the Non-forwarding Situation in Example 2-14

```
;A. Use movz instruction to avoid large load after small
; store, when spills are ignored
movz eax, bl    ; Replaces the last three instructions
                ; in Example 2-12

;B. Use movz instruction and handle spills to the stack
mov DWORD PTR [esp+10h], 00000000h
mov BYTE PTR [esp+10h], bl
movz eax, BYTE PTR [esp+10h] ; not blocked
```

When moving data that is smaller than 64 bits between memory locations, 64-bit or 128-bit SIMD register moves are more efficient (if aligned) and can be used to avoid unaligned loads. Although floating-point registers allow the movement of 64 bits at a time, floating point instructions should not be used for this purpose, as data may be inadvertently modified.

As an additional example, consider the cases in Example 2-16. In the first case (A), there is a large load after a series of small stores to the same area of memory (beginning at memory address `mem`). The large load will stall.

The `fld` must wait for the stores to write to memory before it can access all the data it requires. This stall can also occur with other data types (for example, when bytes or words are stored and then words or doublewords are read from the same area of memory).

Example 2-16 Large and Small Load Stalls

```
;A. Large load stall
mov     mem, eax           ; store dword to address "mem"
mov     mem + 4, ebx       ; store dword to address "mem + 4"
fld     mem                ; load qword at address "mem", stalls

;B. Small Load stall
fstp   mem                ; store qword to address "mem"
mov     bx,mem+2           ; load word at address "mem + 2", stalls
mov     cx,mem+4           ; load word at address "mem + 4", stalls
```

In the second case (Example 2-16, B), there is a series of small loads after a large store to the same area of memory (beginning at memory address `mem`). The small loads will stall.

The word loads must wait for the quadword store to write to memory before they can access the data they require. This stall can also occur with other data types (for example, when doublewords or words are stored and then words or bytes are read from the same area of memory). This can be avoided by moving the store as far from the loads as possible.

Store-forwarding Restriction on Data Availability

The value to be stored must be available before the load operation can be completed. If this restriction is violated, the execution of the load will be delayed until the data is available. This delay causes some execution resources to be used unnecessarily, and that can lead to sizable but non-deterministic delays. However, the overall impact of this problem is much smaller than that from size and alignment requirement violations.

The Pentium 4 and Intel Xeon processors predict when loads are both dependent on and get their data forwarded from preceding stores. These predictions can significantly improve performance. However, if a load is scheduled too soon after the store it depends on or if the generation of the data to be stored is delayed, there can be a significant penalty.

There are several cases where data is passed through memory, where the store may need to be separated from the load:

- spills, save and restore registers in a stack frame
- parameter passing
- global and volatile variables
- type conversion between integer and floating point
- when compilers do not analyze code that is inlined, forcing variables that are involved in the interface with inlined code to be in memory, creating more memory variables and preventing the elimination of redundant loads

Assembly/Compiler Coding Rule 23. (H impact, MH generality) *Where it is possible to do so without incurring other penalties, prioritize the allocation of variables to registers, as in register allocation and for parameter passing to minimize the likelihood and impact of store-forwarding problems. Try not to store-forward data generated from a long latency instruction, e.g. mul, div. Avoid store-forwarding data for variables with the shortest store-load distance. Avoid store-forwarding data for variables with many and/or long dependence chains, and especially avoid including a store forward on a loop-carried dependence chain.*

An example of a loop-carried dependence chain is shown in Example 2-17.

Example 2-17 An Example of Loop-carried Dependence Chain

```
for (i=0; i<MAX; i++) {  
    a[i] = b[i] * foo;  
    foo = a[i]/3;  
} // foo is a loop-carried dependence
```

Data Layout Optimizations

User/Source Coding Rule 2. (H impact, M generality) *Pad data structures defined in the source code so that every data element is aligned to a natural operand size address boundary.*

If the operands are packed in a SIMD instruction, align to the packed element size (64-bit or 128-bit).

Align data by providing padding inside structures and arrays.

Programmers can reorganize structures and arrays to minimize the amount of memory wasted by padding. However, compilers might not have this freedom. The C programming language, for example, specifies the order in which structure elements are allocated in memory. Section “Stack and Data Alignment” of Chapter 3, and Appendix D, “Stack Alignment”, further defines the exact storage layout.

Example 2-18 shows how a data structure could be rearranged to reduce its size.

Example 2-18 Rearranging a Data Structure

```
struct unpacked { /* fits in 20 bytes due to padding */
    int    a;
    char   b;
    int    c;
    char   d;
    int    e;
}
struct packed { /* fits in 16 bytes */
```

Cache line size for Pentium 4 and Pentium M processors can impact streaming applications (for example, multimedia). These reference and use data only once before discarding it. Data accesses which sparsely utilize the data within a cache line can result in less efficient utilization of system memory bandwidth. For example, arrays of structures can be decomposed into several arrays to achieve better packing, as shown in Example 2-19.

Example 2-19 Decomposing an Array

```
struct { /* 1600 bytes */
    int a, c, e;
    char b, d;
} array_of_struct [100];

struct { /* 1400 bytes */
    int a[100], c[100], e[100];
    char b[100], d[100];
} struct_of_array;

struct { /* 1200 bytes */
    int a, c, e;
} hybrid_struct_of_array_ace[100];

struct { /* 200 bytes */
    char b, d;
} hybrid_struct_of_array_bd[100];
```

The efficiency of such optimizations depends on usage patterns. If the elements of the structure are all accessed together but the access pattern of the array is random, then `array_of_struct` avoids unnecessary prefetch even though it wastes memory.

However, if the access pattern of the array exhibits locality, such as if the array index is being swept through, then the Pentium 4 processor prefetches data from `struct_of_array`, even if the elements of the structure are accessed together.

When the elements of the structure are not accessed with equal frequency, such as when element `a` is accessed ten times more often than the other entries, then `struct_of_array` not only saves memory, but it also prevents fetching unnecessary data items `b`, `c`, `d`, and `e`.

Using `struct_of_array` also enables the use of the SIMD data types by the programmer and the compiler.

Note that `struct_of_array` can have the disadvantage of requiring more independent memory stream references. This can require the use of more prefetches and additional address generation calculations. It can also have an impact on DRAM page access efficiency. An alternative, `hybrid_struct_of_array` blends the two approaches. In this case, only 2 separate address streams are generated and referenced: 1 for `hybrid_struct_of_array_ace` and 1 for `hybrid_struct_of_array_bd`. The second alternative also prevents fetching unnecessary data (assuming the variables `a`, `c` and `e` are always used together; whereas the variables `b` and `d` would be also used together, but not at the same time as `a`, `c` and `e`).

The hybrid approach ensures:

- simpler/fewer address generation than `struct_of_array`
- fewer streams, which reduces DRAM page misses
- use of fewer prefetches due to fewer streams
- efficient cache line packing of data elements that are used concurrently.

Assembly/Compiler Coding Rule 24. (H impact, M generality) *Try to arrange data structures such that they permit sequential access.*

If the data is arranged into set of streams, the automatic hardware prefetcher can prefetch data that will be needed by the application, reducing the effective memory latency. If the data is accessed in a non-sequential manner, the automatic hardware prefetcher cannot prefetch the data. The prefetcher can recognize up to eight concurrent streams. See Chapter 6 for more information and the hardware prefetcher.

Memory coherence is maintained on 64-byte cache lines on the Pentium 4, Intel Xeon and Pentium M processors, rather than earlier processors' 32-byte cache lines. This can increase the opportunity for false sharing.

User/Source Coding Rule 3. (M impact, L generality) *Beware of false sharing within a cache line (64 bytes) for Pentium 4, Intel Xeon, and Pentium M processors; and within a sector of 128 bytes on Pentium 4 and Intel Xeon processors.*

Stack Alignment

The easiest way to avoid stack alignment problems is to keep the stack aligned at all times. For example: if a language only supports 8-bit, 16-bit, 32-bit, and 64-bit data quantities, but never uses 80-bit data quantities; the language can require the stack to always be aligned on a 64-bit boundary.

Assembly/Compiler Coding Rule 25. (H impact, M generality) *If 64-bit data is ever passed as a parameter or allocated on the stack, make sure that the stack is aligned to an 8-byte boundary.*

Doing so will require the use of a general purpose register (such as EBP) as a frame pointer. The tradeoff is between causing unaligned 64-bit references if the stack is not aligned and causing extra general purpose register spills if the stack is aligned. Note that a performance penalty is caused only when an unaligned access splits a cache line. This means that one out of eight spatially consecutive unaligned accesses is always penalized.

A routine that makes frequent use of 64-bit data can avoid stack misalignment by placing the code described in Example 2-20 in the function prologue and epilogue.

Example 2-20 Dynamic Stack Alignment

```
prologue:
    subl    esp, 4           ; save frame ptr
    movl   [esp], ebp
    movl   ebp, esp        ; new frame pointer
    andl   ebp, 0xFFFFFFFF ; aligned to 64 bits
    movl   [ebp], esp      ; save old stack ptr
    subl   esp, FRAMESIZE ; allocate space
    ; ... callee saves, etc.
epilogue:
    ; ... callee restores, etc.
    movl   esp, [ebp]      ; restore stack ptr
    movl   ebp, [esp]      ; restore frame ptr
    addl   esp, 4
    ret
```

If for some reason it is not possible to align the stack for 64-bits, the routine should access the parameter and save it into a register or known aligned storage, thus incurring the penalty only once.

Aliasing Cases

There are cases where addresses with a given stride will compete for some resource in the memory hierarchy. Aliasing conditions are specific to each microarchitecture. Note that first-level cache lines are 64 bytes. Thus the least significant 6 bits are not considered in alias comparisons. For the Pentium 4 and Intel Xeon processors, data are loaded into the second level cache in a sector of 128 bytes, so the least significant 7 bits are not considered in alias comparisons.

Aliasing Cases in the Pentium® 4 and Intel® Xeon™ Processors

Pentium 4 processor and Intel Xeon processor aliasing cases are listed below.

- 2K for data – map to the same first-level cache set (32 sets, 64-byte lines). There are 4 ways in the first-level cache, so if there are more than 4 lines that alias to the same 2K modulus in the working set, there will be an excess of first-level cache misses.
- 16K for data – will look the same to the store-forwarding logic. If there has been a store to an address which aliases with the load, the load will stall until the store data is available.
- 16K for code – can only be one of these in the trace cache at a time. If two traces whose starting addresses are 16K apart are in the same working set, the symptom will be a high trace cache miss rate. Solve this by offsetting one of the addresses by one or more bytes.
- 32K for code or data – map to the same second-level cache set (256 sets, 128-byte lines). There are 8 ways in the second-level cache, so if there are more than 8 lines that alias to the same 32K modulus in the working set, there will be an excess of second-level cache misses.
- 64K for data – can only be one of these in the first-level cache at a time. If a reference (load or store) occurs that has bits 0-15 of the linear address identical to a reference (load or store) which is under way, then the second reference cannot begin until the first one is kicked out of the cache. If you avoid this kind of aliasing, you can speedup programs by a factor of three if they load frequently from preceding stores with aliased addresses and there is little other instruction-level parallelism available. The gain is smaller when loads alias with other loads, which cause thrashing in the first-level cache.

If a large number of data structures are in the same working set, accesses to aliased locations in the sets may cause cache thrashing and store forwarding problems. For example, if the code dynamically allocates

many data 3 KB structures, some memory allocators will return starting addresses for these structures which are on 4 KB boundaries. For the sake of simplifying this discussion, suppose these allocations were made to consecutive 4 KB addresses (though that scenario is more likely to be random in a real system). Then every structure would alias with the structure allocated 16 structures after it. The likelihood of aliasing conflicts may increase with the size of the data structures.

Aliasing Cases in the Pentium M Processor

Pentium M processor aliasing cases are listed below.

- First level cache set - 4 KB for data maps to the same first-level cache set (64 sets, 64-byte lines). There are eight ways in the first-level data cache, so if there are more than eight lines that alias to the same 4 KB modulus in the working set, there will be an excess of first-level cache misses.
- Store forwarding - 4 KB for data will look the same to the store-forwarding logic. If there has been a store to an address which aliases with the load, the load will stall until the store data is available.
- Second-level cache set - 128 KB for code or data map to the same second-level cache set (2 KB sets, 64-byte lines). There are eight ways in the second-level cache, so if there are more than eight lines that alias to the same 128 KB modulus in the working set, there will be an excess of second-level cache misses.
- 128 KB for code or data - map to the same second-level cache set (2 KB sets, 64-byte lines). There are 8 ways in the second-level cache, so if there are more than 8 lines that alias to the same 128 k modulus in the working set, there will be an excess of second-level cache misses.

Assembly/Compiler Coding Rule 26. (H impact, MH generality) *Lay out data or order computation to avoid having cache lines that have linear addresses that are a multiple of 64 KB apart in the same working set. Avoid having more than 4 cache lines that are some multiple of 2 KB apart in the same first-level cache working set, and avoid having more than eight cache*

lines that are some multiple of 4 KB apart in the same first-level cache working set. Avoid having more than 8 cache lines that are some multiple of 64 KB apart in the same second-level cache working set. Avoid having a store followed by a non-dependent load with addresses that differ by a multiple of 4 KB.

When declaring multiple arrays that are referenced with the same index and are each a multiple of 64 KB (as can happen with `struct_of_array` data layouts), pad them to avoid declaring them contiguously. Padding can be accomplished by either intervening declarations of other variables, or by artificially increasing the dimension.

User/Source Coding Rule 4. (H impact, ML generality) *Consider using a special memory allocation library to avoid aliasing.*

One way to implement a memory allocator to avoid aliasing is to allocate more than enough space and pad. For example, allocate structures that are 68 KB instead of 64 KB to avoid the 64 KB aliasing; or have the allocator pad and return random offsets that are a multiple of 128 Bytes (the size of a cache line).

User/Source Coding Rule 5. (M impact, M generality) *When padding variable declarations to avoid aliasing, the greatest benefit comes from avoiding aliasing on second-level cache lines, suggesting an offset of 128 bytes or more.*

Mixing Code and Data

The Pentium 4 processor's aggressive prefetching and pre-decoding of instructions has two related effects:

- Self-modifying code works correctly, according to the Intel architecture processor requirements, but incurs a significant performance penalty. Avoid self-modifying code.
- Placing writable data in the code segment might be impossible to distinguish from self-modifying code. Writable data in the code segment might suffer the same performance penalty as self-modifying code.

Assembly/Compiler Coding Rule 27. (M impact, L generality) *If (hopefully read-only) data must occur on the same page as code, avoid placing it immediately after an indirect jump. For example, follow an indirect jump with its mostly likely target, and place the data after an unconditional branch.*

Tuning Suggestion 1. *In rare cases, a performance problem may be noted due to executing data on a code page as instructions. The condition where this is very likely to happen is when execution is following an indirect branch that is not resident in the trace cache. If a performance problem is clearly due to this cause, try moving the data elsewhere or inserting an illegal opcode or a pause instruction immediately following the indirect branch. The latter two alternatives may degrade performance in some circumstances.*

Assembly/Compiler Coding Rule 28. (H impact, L generality) *Always put code and data on separate pages. Avoid self-modifying code wherever possible. If code is to be modified, try to do it all at once and make sure the code that performs the modifications and the code being modified are on separate 4 KB pages or on separate aligned 1 KB subpages.*

Self-modifying Code

Self-modifying code (SMC) that ran correctly on Pentium III processors and prior implementations will run correctly on subsequent implementations, including Pentium 4 and Intel Xeon processors. SMC and cross-modifying code (when more than one processor in a multi-processor system are writing to a code page) should be avoided when high performance is desired.

Software should avoid writing to a code page in the same 1 KB subpage of that is being executed or fetching code in the same 2 KB subpage of that is currently being written. In addition, sharing a page containing directly or speculatively executed code with another processor as a data page can trigger an SMC condition that causes the entire pipeline of the machine and the trace cache to be cleared. This is due to the self-modifying code condition.

Dynamic code need not cause the SMC condition if the code written fills up a data page before that page is accessed as code.

Dynamically-modified code (for example, from target fix-ups) is likely

to suffer from the SMC condition and should be avoided where possible. Avoid the condition by introducing indirect branches and using data tables on data (not code) pages via register-indirect calls.

Write Combining

Write combining (WC) improves performance in two ways:

- On a write miss to the first-level cache, it allows multiple stores to the same cache line to occur before that cache line is read for ownership (RFO) from further out in the cache/memory hierarchy. Then the rest of line is read, and the bytes that have not been written are combined with the unmodified bytes in the returned line.
- Write combining allows multiple writes to be assembled and written further out in the cache hierarchy as a unit. This saves port and bus traffic. Saving traffic is particularly important for avoiding partial writes to uncached memory.

There are 6 write-combining buffers. Two of these buffers may be written out to higher cache levels and freed up for use on other write misses; only four write-combining buffers are guaranteed to be available for simultaneous use.

Assembly/Compiler Coding Rule 29. (H impact, L generality) *If an inner loop writes to more than four arrays, (four distinct cache lines), apply loop fission to break up the body of the loop such that only four arrays are being written to in each iteration of each of the resulting loops.*

The write combining buffers are used for stores of all memory types. They are particularly important for writes to uncached memory: writes to different parts of the same cache line can be grouped into a single, full-cache-line bus transaction instead of going across the bus (since they are not cached) as several partial writes. Avoiding partial writes can have a significant impact on bus bandwidth-bound graphics applications, where graphics buffers are in uncached memory. Separating writes to uncached memory and writes to writeback memory into separate phases can assure that the write combining buffers can fill before getting evicted by other write traffic. Eliminating partial write

transactions has been found to have performance impact of the order of 20% for some applications. Because the cache lines are 64 bytes, a write to the bus for 63 bytes will result in 8 partial bus transactions.

When coding functions that execute simultaneously on two threads, reducing the number of writes that are allowed in an inner loop will help take full advantage of write-combining store buffers. See Chapter 7 for the write-combining buffer recommendation with Hyper-Threading Technology.

Store ordering and visibility are also important issues for write combining. When a write to a write-combining buffer for a previously-unwritten cache line occurs, there will be a read-for-ownership (RFO). If a subsequent write happens to another write-combining buffer, a separate RFO may be caused for that cache line. Subsequent writes to the first cache line and write-combining buffer will be delayed until the second RFO has been serviced to guarantee properly ordered visibility of the writes. If the memory type for the writes is write-combining, there will be no RFO since the line is not cached, and there is no such delay. For details on write-combining, see the *Intel Architecture Software Developer's Manual*.

Locality Enhancement

Although cache miss rates may be low, processors typically spend a sizable portion of their execution time waiting for cache misses to be serviced. Reducing cache misses by enhancing a program's locality is a key optimization. This can take several forms:

- blocking to iterate over a portion of an array that will fit in the cache
- loop interchange to avoid crossing cache lines or page boundaries
- loop skewing to make accesses contiguous

It is also important to avoid operations that work against locality-enhancing techniques. Using the lock prefix heavily can incur large delays when accessing memory, irrespective of whether the data is in the cache or in system memory.

User/Source Coding Rule 6. (H impact, H generality) *Optimization techniques such as blocking, loop interchange, loop skewing and packing are best done by the compiler. Optimize data structures to either fit in one-half of the first-level cache or in the second-level cache; turn on loop optimizations in the compiler to enhance locality for nested loops.*

Optimizing for one-half of the first-level cache will bring the greatest performance benefit. If one-half of the first-level cache is too small to be practical, optimize for the second-level cache. Optimizing for a point in between (for example, for the entire first-level cache) will likely not bring a substantial improvement over optimizing for the second-level cache.

Minimizing Bus Latency

The system bus on Xeon and Pentium 4 processors provides up to 4.2 GB/sec bandwidth of throughput at 133 MHz scalable bus clock rate (See MSR_EBC_FREQUENCY_ID register). The peak bus bandwidth is even higher with higher bus clock rates.

Each bus transaction includes the overhead of making request and arbitrations. The average latency of bus read and bus write transactions will be longer if reads and writes alternate. Segmenting reads and writes into phases can reduce the average latency of bus transactions. This is because the number of incidences of successive transactions involving a read following a write or a write following a read are reduced.

User/Source Coding Rule 7. (M impact, ML generality) *If there is a blend of reads and writes on the bus, changing the code to separate these bus transactions into read phases and write phases can help performance.*

Note, however, that the order of read and write operations on the bus are not the same as they appear in the program.

Non-Temporal Store Bus Traffic

Peak system bus bandwidth is shared by several types of bus activities, including: reads (from memory), read for ownership (of a cache line), and writes. The data transfer rate for bus write transactions is higher if 64 bytes are written out to the bus at a time.

Typically, bus writes to Writeback (WB) type memory must share the system bus bandwidth with read-for-ownership (RFO) traffic. Non-temporal stores do not require RFO traffic; they do require care in managing the access patterns in order to ensure 64 bytes are evicted at once (rather than evicting several 8 byte chunks).

Although full 64-byte bus writes due to non-temporal stores have data bandwidth that is twice that of bus writes to WB memory, transferring 8-byte chunks wastes bus request bandwidth and delivers significantly lower data bandwidth.

Example 2-21 Non-temporal stores and 64-byte bus write transactions

```
#define STRIDESIZE 256
Lea ecx, p64byte_Aligned
Mov edx, ARRAY_LEN
Xor eax, eax
sloop:
movntps XMMWORD ptr [ecx + eax], xmm0
movntps XMMWORD ptr [ecx + eax+16], xmm0
movntps XMMWORD ptr [ecx + eax+32], xmm0
movntps XMMWORD ptr [ecx + eax+48], xmm0
; 64 bytes is written in one bus transaction
add eax, STRIDESIZE
cmp eax, edx
jl sloop
```

Example 2-22 Non-temporal stores and partial bus write transactions

```
#define STRIDESIZE 256
Lea ecx, p64byte_Aligned
Mov edx, ARRAY_LEN
Xor eax, eax
sloop:
movntps XMMWORD ptr [ecx + eax], xmm0
movntps XMMWORD ptr [ecx + eax+16], xmm0
movntps XMMWORD ptr [ecx + eax+32], xmm0
; Storing 48 bytes results in 6 bus partial transactions
add eax, STRIDESIZE
cmp eax, edx
```

Prefetching

The Pentium 4 processor has three prefetching mechanisms:

- hardware instruction prefetcher

- software prefetch for data
- hardware prefetch for cache lines of data or instructions.

Hardware Instruction Fetching

The hardware instruction fetcher reads instructions, 32 bytes at a time, into the 64-byte instruction streaming buffers.

Software and Hardware Cache Line Fetching

The Pentium 4 and Intel Xeon processors provide hardware prefetching, in addition to software prefetching. The hardware prefetcher operates transparently to fetch data and instruction streams from memory, without requiring programmer intervention. The hardware prefetcher can track 8 independent streams. Software prefetch using the `prefetchnta` instruction fetches 128 bytes into one way of the second-level cache.

The Pentium M processor also provides a hardware prefetcher for data. It can track 12 separate streams in the forward direction and 4 streams in the backward direction. This processor's `prefetchnta` instruction also fetches 64-bytes into the first-level data cache without polluting the second-level cache.

Typically, prefetching can provide significant gains. The use of prefetches is recommended. The hardware prefetcher is best for linear data access patterns in either direction. Software prefetch can complement the hardware prefetcher if used carefully.

There is a trade-off to make between hardware and software prefetching. This pertains to application characteristics such as regularity and stride of accesses. Bus bandwidth, issue bandwidth (the latency of loads on the critical path) and whether access patterns are suitable for non-temporal prefetch will also have an impact.

For a detailed description of how to use prefetching, see Chapter 6, “Optimizing Cache Usage”.

User/Source Coding Rule 8. (M impact, H generality) *Enable the prefetch generation in your compiler. Note: As a compiler's prefetch implementation improves, it is expected that its prefetch insertion will outperform manual insertion except for that done by code tuning experts, but this is not always the case. If the compiler does not support software prefetching, intrinsics or inline assembly may be used to manually insert prefetch instructions.*

Chapter 6 contains an example of using software prefetch to implement memory copy algorithm.

Tuning Suggestion 2. *If a load is found to miss frequently, either insert a prefetch before it, or, if issue bandwidth is a concern, move the load up to execute earlier.*

Cacheability instructions

SSE2 provides additional cacheability instructions that extend further from the cacheability instructions provided in SSE. The new cacheability instructions include:

- new streaming store instructions
- new cache line flush instruction
- new memory fencing instructions

For a detailed description of using cacheability instructions, see Chapter 6.

Code Alignment

Because the trace cache (TC) removes the decoding stage from the pipeline for frequently executed code, optimizing code alignment for decoding is not as important for Pentium 4 and Intel Xeon processors.

For the Pentium M processor, code alignment and the alignment of branch target will affect the throughput of the decoder.

Careful arrangement of code can enhance cache and memory locality. Likely sequences of basic blocks should be laid out contiguously in memory. This may involve pulling unlikely code, such as code to handle error conditions, out of that sequence. See “Prefetching” section on how to optimize for the instruction prefetcher.

Assembly/Compiler Coding Rule 30. (M impact, H generality) *All branch targets should be 16-byte aligned.*

Assembly/Compiler Coding Rule 31. (M impact, H generality) *If the body of a conditional is not likely to be executed, it should be placed in another part of the program. If it is highly unlikely to be executed and code locality is an issue, the body of the conditional should be placed on a different code page.*

Improving the Performance of Floating-point Applications

When programming floating-point applications, it is best to start with a high-level programming language such as C, C++ or Fortran. Many compilers perform floating-point scheduling and optimization when it is possible. However in order to produce optimal code, the compiler may need some assistance.

Guidelines for Optimizing Floating-point Code

User/Source Coding Rule 9. (M impact, M generality) *Enable the compiler’s use of SSE2 instructions with appropriate switches.*

Follow this procedure to investigate the performance of your floating-point application:

- Understand how the compiler handles floating-point code.
- Look at the assembly dump and see what transforms are already performed on the program.
- Study the loop nests in the application that dominate the execution time.
- Determine why the compiler is not creating the fastest code.
- See if there is a dependence that can be resolved.

- Determine the problem area: bus bandwidth, cache locality, trace cache bandwidth or instruction latency. Focus on optimizing the problem area. For example, adding prefetch instructions will not help if the bus is already saturated. If trace cache bandwidth is the problem, added prefetch μ ops may degrade performance.

For floating-point coding, follow all the general coding recommendations discussed in this chapter, including:

- blocking the cache
- using prefetch
- enabling vectorization
- unrolling loops

User/Source Coding Rule 10. (H impact, ML generality) *Make sure your application stays in range to avoid denormal values, underflows.*

Out-of-range numbers cause very high overhead.

User/Source Coding Rule 11. (M impact, ML generality) *Do not use double precision unless necessary. Set the precision control (PC) field in the x87 FPU control word to “Single Precision”. This allows single precision (32-bit) computation to complete faster on some operations (for example, divides due to early out). However, be careful of introducing more than a total of two values for the floating point control word, or there will be a large performance penalty. See “Floating-point Modes”.*

User/Source Coding Rule 12. (H impact, ML generality) *Use fast float-to-int routines. If coding these routines, use the `cvttss2si`, `cvttss2si` instructions if coding with Streaming SIMD Extensions 2.*

Many libraries do more work than is necessary. The instructions `cvttss2si/cvttss2si` save many μ ops and some store-forwarding delays over some compiler implementations. This avoids changing the rounding mode.

User/Source Coding Rule 13. (M impact, ML generality) *Break dependence chains where possible.*

For example, to calculate $z = a + b + c + d$, instead of:

```
x = a + b;  
y = x + c;  
z = y + d;
```

use:

```
x = a + b;  
y = c + d;  
z = x + y;
```

User/Source Coding Rule 14. (M impact, ML generality) *Usually, math libraries take advantage of the transcendental instructions (for example, `fsin`) when evaluating elementary functions. If there is no critical need to evaluate the transcendental functions using the extended precision of 80 bits, applications should consider alternate, software-based approach, such as look-up-table-based algorithm using interpolation techniques. It is possible to improve transcendental performance with these techniques by choosing the desired numeric precision, the size of the look-up table and taking advantage of the parallelism of the Streaming SIMD Extensions and the Streaming SIMD Extensions 2 instructions.*

Floating-point Modes and Exceptions

When working with floating-point numbers, high-speed microprocessors frequently must deal with situations that need special handling in hardware or code. The Pentium 4 processor is optimized to handle the most common cases of such situations efficiently.

Floating-point Exceptions

The most frequent situation that can lead to performance degradation involve masked floating-point exception conditions such as:

- arithmetic overflow
- arithmetic underflow
- denormalized operand

Refer to Chapter 4 of the *IA-32 Intel® Architecture Software Developer's Manual*, Volume 1 for the definition of overflow, underflow and denormal exceptions.

Denormalized floating-point numbers impact performance in two ways:

- directly: when they are used as operands
- indirectly: when they are produced as a result of an underflow situation

If a floating-point application never underflows, the denormals can only come from floating-point constants.

User/Source Coding Rule 15. (H impact, ML generality) *Denormalized floating-point constants should be avoided as much as possible.*

Denormal and arithmetic underflow exceptions can occur during the execution of either x87 instructions or SSE/SSE2 instructions. The Pentium 4 processor can handle these exceptions more efficiently when executing SSE/SSE2 instructions and when speed is more important than complying to IEEE standard. The following two paragraphs give recommendations on how to optimize your code to reduce performance degradations related to floating-point exceptions.

Dealing with floating-point exceptions in x87 FPU code

Every special situation listed in the “Floating-point Exceptions” section is costly in terms of performance. For that reason, x87 FPU code should be written to avoid these situations.

There are basically three ways to reduce the impact of overflow/underflow situations with x87 FPU code:

- Choose floating-point data types that are large enough to accommodate results without generating arithmetic overflow and underflow exceptions.
- Scale the range of operands/results to reduce as much as possible the number of arithmetic overflow/underflow situations.

- Keep intermediate results on the x87 FPU register stack until the final results have been computed and stored to memory. Overflow or underflow is less likely to happen when intermediate results are kept in the x87 FPU stack (this is because data on the stack is stored in double extended-precision format and overflow/underflow conditions are detected accordingly).

Denormalized floating-point constants (which are read only, and hence never change) should be avoided and replaced, if possible, with zeros of the same sign.

Dealing with Floating-point Exceptions in SSE and SSE2 code

Most special situations that involve masked floating-point exceptions are handled efficiently on the Pentium 4 processor. When a masked overflow exception occurs while executing SSE or SSE2 code, the Pentium 4 processor handles it without performance penalty.

Underflow exceptions and denormalized source operands are usually treated according to the IEEE 754 specification. If a programmer is willing to trade pure IEEE 754 compliance for speed, two non-IEEE 754 compliant modes are provided to speed situations where underflows and input are frequent: FTZ mode and DAZ mode.

When the FTZ mode is enabled, an underflow result is automatically converted to a zero with the correct sign. Although this behavior is not IEEE 754 compliant, it is provided for use in applications where performance is more important than IEEE 754 compliance. Since denormal results are not produced when the FTZ mode is enabled, the only denormal floating-point numbers that can be encountered in FTZ mode are the ones specified as constants (read only).

The DAZ mode is provided to handle denormal source operands efficiently when running an SSE application. When the DAZ mode is enabled, input denormals are treated as zeros with the same sign. Enabling the DAZ mode is the way to deal with denormal floating-point constants when performance is the objective.

If departing from IEEE 754 specification is acceptable and if performance is critical, run an SSE/SSE2 application with FTZ and DAZ modes enabled.



NOTE. *The DAZ mode is available with both the SSE and SSE2 extensions, although the speed improvement expected from this mode is fully realized only in SSE code.*

Floating-point Modes

On the Pentium III processor, the `FLDCW` instruction is an expensive operation. On the Pentium 4 processor, `FLDCW` is improved for situations where an application alternates between two constant values of the x87 FPU control word (FCW), such as when performing conversions to integers.

Specifically, the optimization for `FLDCW` allows programmers to alternate between two constant values efficiently. For the `FLDCW` optimization to be effective, the two constant FCW values are only allowed to differ on the following 5 bits in the FCW:

FCW[8-9]	precision control
FCW[10-11]	rounding control
FCW[12]	infinity control

If programmers need to modify other bits (for example: mask bits) in the FCW, the `FLDCW` instruction is still an expensive operation.

In situations where an application cycles between three (or more) constant values, `FLDCW` optimization does not apply and the performance degradation occurs for each `FLDCW` instruction.

One solution to this problem is to choose two constant FCW values, take advantage of the optimization of the `FLDCW` instruction to alternate between only these two constant FCW values, and devise some means

to accomplish the task that requires the 3rd FCW value without actually changing the FCW to a third constant value. An alternative solution is to structure the code so that, for periods of time, the application alternates between only two constant FCW values. When the application later alternates between a pair of different FCW values, the performance degradation occurs only during the transition.

It is expected that SIMD applications are unlikely to alternate FTZ and DAZ mode values. Consequently, the SIMD control word does not have the short latencies that the floating-point control register does. A read of the `MXCSR` register has a fairly long latency, and a write to the register is a serializing instruction.

There is no separate control word for single and double precision; both use the same modes. Notably, this applies to both FTZ and DAZ modes.

Assembly/Compiler Coding Rule 32. (H impact, M generality) *Minimize changes to bits 8-12 of the floating point control word. Changes for more than two values (each value being a combination of the following bits: precision, rounding and infinity control, and the rest of bits in FCW) leads to delays that are on the order of the pipeline depth.*

Rounding Mode

Many libraries provide the float-to-integer library routines that convert floating-point values to integer. Many of these libraries conform to ANSI C coding standards which state that the rounding mode should be truncation. With the Pentium 4 processor, one can use the `cvttss2si` and `cvttsd2si` instructions to convert operands with truncation and without ever needing to change rounding modes. The cost savings of using these instructions over the methods below is enough to justify using Streaming SIMD Extensions and Streaming SIMD Extensions 2 wherever possible when truncation is involved.

For x87 floating point, the `fist` instruction uses the rounding mode represented in the floating-point control word (FCW). The rounding mode is generally round to nearest, therefore many compiler writers implement a change in the rounding mode in the processor in order to conform to the C and FORTRAN standards. This implementation

requires changing the control word on the processor using the `fldcw` instruction. For a change in the rounding, precision, and infinity bits; use the `fstcw` instruction to store the floating-point control word. Then use the `fldcw` instruction to change the rounding mode to truncation.

In a typical code sequence that changes the rounding mode in the FCW, a `fstcw` instruction is usually followed by a load operation. The load operation from memory should be a 16-bit operand to prevent store-forwarding problem. If the load operation on the previously-stored FCW word involves either an 8-bit or a 32-bit operand, this will cause a store-forwarding problem due to mismatch of the size of the data between the store operation and the load operation.

Make sure that the write and read to the FCW are both 16-bit operations, to avoid store-forwarding problems.

If there is more than one change to rounding, precision and infinity bits and the rounding mode is not important to the result; use the algorithm in Example 2-23 to avoid synchronization issues, the overhead of the `fldcw` instruction and having to change the rounding mode. The provided example suffers from a store-forwarding problem which will lead to a performance penalty. However, its performance is still better than changing the rounding, precision and infinity bits among more than two values.

Example 2-23 Algorithm to Avoid Changing the Rounding Mode

```
_ftol32proc
    lea    ecx,[esp-8]
    sub    esp,16          ; allocate frame
    and    ecx,-8         ; align pointer on boundary of 8
    fld    st(0)          ; duplicate FPU stack top
    fistp  qword ptr[ecx]
    fild   qword ptr[ecx]
    mov    edx,[ecx+4]; high dword of integer
    mov    eax,[ecx]      ; low dword of integer
    test   eax,eax
    je     integer_QNaN_or_zero
arg_is_not_integer_QNaN:
    fsubp  st(1),st       ; TOS=d-round(d),
                        ; { st(1)=st(1)-st & pop ST}
    test   edx,edx       ; what's sign of integer
```

continued

Example 2-23 Algorithm to Avoid Changing the Rounding Mode (continued)

```
jns     positive      ; number is negative
fstp   dword ptr[ecx]; result of subtraction
mov    ecx,[ecx]     ; dword of diff(single-
                    ; precision)

add    esp,16
xor    ecx,80000000h
add    ecx,7fffffffh ; if diff<0 then decrement
                    ; integer
adc    eax,0         ; inc eax (add CARRY flag)
ret

positive:
fstp   dword ptr[ecx] ; 17-18 result of subtraction
mov    ecx,[ecx]     ; dword of diff(single precision)
add    esp,16
add    ecx,7fffffffh ; if diff<0 then decrement integer
sbb   eax,0         ; dec eax (subtract CARRY flag)
ret

integer_QNaN_or_zero:
test   edx,7fffffffh
jnz    arg_is_not_integer_QNaN
add   esp,16
ret
```

Assembly/Compiler Coding Rule 33. (H impact, L generality) *Minimize the number of changes to the rounding mode. Do not use changes in the rounding mode to implement the floor and ceiling functions if this involves a total of more than two values of the set of rounding, precision and infinity bits.*

Precision

If single precision is adequate, use it instead of double precision. This is true because:

- Single precision operations allow the use of longer SIMD vectors, since more single precision data elements can fit in a register.
- If the precision control (PC) field in the x87 FPU control word is set to “Single Precision,” the floating-point divider can complete a single-precision computation much faster than either a double-precision computation or an extended double-precision computation. If the PC field is set to “Double Precision,” this will enable those x87 FPU operations on double-precision data to complete faster than extended double-precision computation. These characteristics affect computations including floating-point divide and square root.

Assembly/Compiler Coding Rule 34. (H impact, L generality) *Minimize the number of changes to the precision mode.*

Improving Parallelism and the Use of FXCH

The x87 instruction set relies on the floating point stack for one of its operands. If the dependence graph is a tree, which means each intermediate result is used only once and code is scheduled carefully, it is often possible to use only operands that are on the top of the stack or in memory, and to avoid using operands that are buried under the top of the stack. When operands need to be pulled from the middle of the stack, an `fxch` instruction can be used to swap the operand on the top of the stack with another entry in the stack.

The `fxch` instruction can also be used to enhance parallelism. Dependent chains can be overlapped to expose more independent instructions to the hardware scheduler. An `fxch` instruction may be required to effectively increase the register name space so that more operands can be simultaneously live.

Note, however, that `fxch` inhibits issue bandwidth in the trace cache. It does this not only because it consumes a slot, but also because of issue slot restrictions imposed on `fxch`. If the application is not bound by issue or retirement bandwidth, `fxch` will have no impact.

The Pentium 4 processor's effective instruction window size is large enough to permit instructions that are as far away as the next iteration to be overlapped. This often obviates the need to use `fxch` to enhance parallelism.

The `fxch` instruction should be used only when it's needed to express an algorithm or to enhance parallelism. If the size of register name space is a problem, the use of XMM registers is recommended (see the section).

Assembly/Compiler Coding Rule 35. (M impact, M generality) *Use `fxch` only where necessary to increase the effective name space.*

This in turn allows instructions to be reordered to make instructions available to be executed in parallel. Out-of-order execution precludes the need for using `fxch` to move instructions for very short distances.

x87 vs. SIMD Floating-point Trade-offs

There are a number of differences between x87 floating-point code and scalar floating-point code (using SSE and SSE2). The following differences drive decisions about which registers and instructions to use:

- When an input operand for a SIMD floating-point instruction contains values that are less than the representable range of the data type, a denormal exception occurs. This causes significant performance penalty. SIMD floating-point operation has a flush-to-zero mode. In flush-to-zero mode, the results will not underflow. Therefore subsequent computation will not face the performance penalty of handling denormal input operands. For example, in the case of 3D applications with low lighting levels, using flush-to-zero mode can improve performance by as much as 50% for applications with large numbers underflows.

- Scalar floating point has lower latencies. This generally does not matter much as long as resource utilization is low.
- Only x87 supports transcendental instructions.
- x87 supports 80-bit precision, double extended floating point. Streaming SIMD Extensions support a maximum of 32-bit precision, and Streaming SIMD Extensions 2 supports a maximum of 64-bit precision.
- On the Pentium 4 processor, floating point adds are pipelined for x87 but not for scalar floating-point code. Floating point multiplies are not pipelined for either case. For applications with a large number of floating-point adds relative to the number of multiplies, x87 may be a better choice.
- Scalar floating-point registers may be accessed directly, avoiding `fxch` and top-of-stack restrictions. On the Pentium 4 processor, the floating-point register stack may be used simultaneously with XMM registers. The same hardware is used for both kinds of instructions, but the added name space may be beneficial.
- The cost of converting from floating point to integer with truncation is significantly lower with Streaming SIMD Extensions 2 and Streaming SIMD Extensions in the Pentium 4 processor than with either changes to the rounding mode or the sequence prescribed in the Example 2-23 above.

Assembly/Compiler Coding Rule 36. (M impact, M generality) *Use Streaming SIMD Extensions 2 or Streaming SIMD Extensions unless you need an x87 feature. Most SSE2 arithmetic operations have shorter latency than their X87 counterpart and they eliminate the overhead associated with the management of the X87 register stack.*

Memory Operands

Double-precision floating-point operands that are eight-byte aligned have better performance than operands that are not eight-byte aligned, since they are less likely to incur penalties for cache and MOB splits. Floating-point operation on a memory operands require that the operand

be loaded from memory. This incurs an additional μop , which can have a minor negative impact on front end bandwidth. Additionally, memory operands may cause a data cache miss, causing a penalty.

Floating-Point Stalls

Floating-point instructions have a latency of at least two cycles. But, because of the out-of-order nature of Pentium II and the subsequent processors, stalls will not necessarily occur on an instruction or μop basis. However, if an instruction has a very long latency such as an `fdiv`, then scheduling can improve the throughput of the overall application.

x87 Floating-point Operations with Integer Operands

For Pentium 4 processor, splitting floating-point operations (`fiadd`, `fisub`, `fimul`, and `fdiv`) that take 16-bit integer operands into two instructions (`fld` and a floating-point operation) is more efficient. However, for floating-point operations with 32-bit integer operands, using `fiadd`, `fisub`, `fimul`, and `fdiv` is equally efficient compared with using separate instructions.

Assembly/Compiler Coding Rule 37. (M impact, L generality) *Try to use 32-bit operands rather than 16-bit operands for `fld`. However, do not do so at the expense of introducing a store forwarding problem by writing the two halves of the 32-bit memory operand separately.*

x87 Floating-point Comparison Instructions

On Pentium II and the subsequent processors, the `fcomi` and `fcmov` instructions should be used when performing floating-point comparisons. Using (`fcom`, `fcomp`, `fcompp`) instructions typically requires additional instruction like `fstsw`. The latter alternative causes more μops to be decoded, and should be avoided.

Transcendental Functions

If an application needs to emulate math functions in software due to performance or other reasons (see the “Guidelines for Optimizing Floating-point Code” section), it may be worthwhile to inline math library calls because the `call` and the prologue/epilogue involved with such calls can significantly affect the latency of operations.

Note that transcendental functions are supported only in x87 floating point, not in Streaming SIMD Extensions or Streaming SIMD Extensions 2.

Instruction Selection

This section explains how to generate optimal assembly code. The listed optimizations have been shown to contribute to the overall performance at the application level on the order of 5%. Performance gain for individual applications may vary.

The recommendations are prioritized as follows:

- Choose instructions with shorter latencies and fewer μ ops.
- Use optimized sequences for clearing and comparing registers.
- Enhance register availability.
- Avoid prefixes, especially more than one prefix.

Assembly/Compiler Coding Rule 38. (M impact, H generality) *Choose instructions with shorter latencies and fewer micro-ops. Favor single-micro-operation instructions.*

A compiler may be already doing a good job on instruction selection as it is. In that case, user intervention usually is not necessary.

Assembly/Compiler Coding Rule 39. (M impact, L generality) *Avoid prefixes, especially multiple non-OF-prefixed opcodes.*

Assembly/Compiler Coding Rule 40. (M impact, L generality) *Do not use many segment registers.*

On the Pentium M processor, there is only one level of renaming of segment registers.

Complex Instructions

Assembly/Compiler Coding Rule 41. (ML impact, M generality) *Avoid using complex instructions (for example, `enter`, `leave`, or `loop`) that have more than four μ ops and require multiple cycles to decode. Use sequences of simple instructions instead.*

Complex instructions may save architectural registers, but incur a penalty of 4 μ ops to set up parameters for the microcode ROM.

Use of the `lea` Instruction

In many cases, the `lea` instruction or a sequence of `lea`, `add`, `sub` and `shift` instructions can replace constant multiply instructions. The `lea` instruction can also be used as a multiple operand addition instruction, for example:

```
lea ecx, [eax + ebx + 4 + a]
```

Using `lea` in this way may avoid some register usage by not tying up registers for the operands of arithmetic instructions. It may also save code space.

The `lea` instruction is not always as fast on the Pentium 4 processor as it is on Pentium II and Pentium III processors. This is due to the fact that the `lea` instruction can produce a shift μ op.

If the `lea` instruction uses a shift by a constant amount then the latency of the sequence of μ ops is shorter if `adds` are used instead of a shift, and the `lea` instruction may be replaced with an appropriate sequence of μ ops. This, however, increases the total number of μ ops, leading to a trade-off.

Assembly/Compiler Coding Rule 42. (ML impact, M generality) *If a `lea` instruction using the scaled index is on the critical path, a sequence with `adds` may be better. If code density and bandwidth out of the trace cache are the critical factor, then use the `lea` instruction.*

Use of the `inc` and `dec` Instructions

The `inc` and `dec` instructions modify only a subset of the bits in the flag register. This creates a dependence on all previous writes of the flag register. This is especially problematic when these instructions are on the critical path because they are used to change an address for a load on which many other instructions depend.

Assembly/Compiler Coding Rule 43. (M impact, H generality) *`inc` and `dec` instructions should be replaced with an `add` or `sub` instruction, because `add` and `sub` overwrite all flags, whereas `inc` and `dec` do not, therefore creating false dependencies on earlier instructions that set the flags.*

Use of the `shift` and `rotate` Instructions

The `shift` and `rotate` instructions have a longer latency on the Pentium 4 processor than on previous processor generations. The latency of a sequence of `adds` will be shorter for left shifts of three or less. Fixed and variable shifts have the same latency.

The `rotate by immediate` and `rotate by register` instructions are more expensive than a `shift`. The `rotate by 1` instruction has the same latency as a `shift`.

Assembly/Compiler Coding Rule 44. (ML impact, L generality) *Avoid `rotate by register` or `rotate by immediate` instructions. If possible, replace with a `rotate by 1` instruction.*

Integer and Floating-point Multiply

On Pentium 4 and Intel Xeon processors, the integer multiply operations, `mul` and `imul`, are executed in the floating-point unit so these instructions should not be executed in parallel with a floating-point instruction. They also incur extra latency due to being executed on the floating-point unit.

The floating-point multiply instruction (`fmul`) delays for one cycle if the immediately preceding cycle executed an `fmul`. The multiplier can only accept a new pair of operands every other cycle.

Assembly/Compiler Coding Rule 45. (M impact, MH generality) *Replace integer multiplies by a small constant with two or more `add` and `lea` instructions, especially when these multiplications is part of a dependence chain.*

Integer Divide

Typically, an integer divide is preceded by a `cwd` or `cdq` instruction. Depending on the operand size, divide instructions use `DX:AX` or `EDX:EAX` for the dividend. The `cwd` or `cdq` instructions sign-extend `AX` or `EAX` into `DX` or `EDX`, respectively. These instructions are denser encoding than a `shift` and `move` would be, but they generate the same number of `mops`. If `AX` or `EAX` are known to be positive, replace these instructions with

```
xor dx, dx
```

or

```
xor edx, edx
```

Assembly/Compiler Coding Rule 46. (ML impact, L generality) *Use `cdw` or `cdq` instead of a `shift` and a `move`. Replace these with an `xor` whenever `AX` or `EAX` is known to be positive.*

Operand Sizes

The Pentium 4 processor does not incur a penalty for partial register accesses as does the Pentium M processor, since every operation on a partial register updates the whole register. However, this does mean that there may be false dependencies between *any* references to partial registers.

Example 2-24 demonstrates a series of false and real dependencies caused by referencing partial registers.

Example 2-24 Dependencies Caused by Referencing Partial Registers

```

1:  add    ah, bh
2:  add    al, 3      ; instruction 2 has a false dependency on 1
3:  mov    bl, al     ; depends on 2, but the dependence is real
4:  mov    ah, ch     ; instruction 4 has a false dependency on 2
5:  sar    eax, 16    ; this wipes out the al/ah/ax part, so the
    ; result really doesn't depend on them programatically,
    ; but the processor must deal with the real dependency on
    al/ah/ax
6:  mov    al, bl     ; instruction 6 has a real dependency on 5
7:  add    ah, 13     ; instruction 7 has a false dependency on 6
8:  imul   dl         ; instruction 8 has a false dependency on 7
    ; because al is implicitly used
9:  mov    al, 17     ; instruction 9 has a false dependency on 7
    ; and a real dependency on 8
10: imul  cx         : implicitly uses ax and writes to dx, hence
    ; a real dependency

```

If instructions 4 and 6 (see Example 2-24) are changed to use a `movzx` instruction instead of a `mov`, then the dependences of instructions 4 on 2 (and transitively 1 before it), and instructions 6 on 5 are broken. This

creates two independent chains of computation instead of one serial one. In a tight loop with limited parallelism, the resulting optimization can yield several percent performance improvement.

Assembly/Compiler Coding Rule 47. (ML impact, L generality) *Use simple instructions that are less than eight bytes in length.*

Assembly/Compiler Coding Rule 48. (M impact, MH generality) *Avoid using prefixes to change the size of immediate and displacement.*

Long instructions (more than seven bytes) limit the number of decoded instructions per cycle on the Pentium M processor. Each prefix adds one byte to the length of instruction, possibly limiting the decoder's throughput. In addition, multiple prefixes can only be decoded by the first decoder. These prefixes also incur a delay when decoded. If multiple prefixes or a prefix that changes the size of an immediate or displacement cannot be avoided, schedule them behind instructions that stall the pipe for some other reason.

Assembly/Compiler Coding Rule 49. (M impact, MH generality) *Break dependences on portions of registers between instructions by operating on 32-bit registers instead of partial registers. For moves, this can be accomplished with 32-bit moves or by using `movzx`.*

On Pentium M processors, the `movsx` and `movzx` instructions both take a single μop , whether they move from a register or memory. On Pentium 4 processors, the `movsx` takes an additional μop . This is likely to cause less delay than the partial register update problem mentioned above, but the performance gain may vary. If the additional μop is a critical problem, `movsx` can sometimes be used as alternative.

Sometimes sign-extended semantics can be maintained by zero-extending operands. For example, the C code in the following statements does not need sign extension, nor does it need prefixes for operand size overrides:

```
static short int a, b;
if (a == b) {
    . . .
}
```

Code for comparing these 16-bit operands might be:

```
movzw  eax, [a]
movzw  ebx, [b]
cmp    eax, ebx
```

These circumstances tend to be common. However, the technique will not work if the compare is for greater than, less than, greater than or equal, and so on; or if the values in `eax` or `ebx` are to be used in another operation where sign extension is required.

Assembly/Compiler Coding Rule 50. (M impact, M generality) *Try to use zero extension or operate on 32-bit operands instead of using moves with sign extension.*

The trace cache can be packed more tightly when instructions with operands that can only be represented as 32 bits are not adjacent.

Assembly/Compiler Coding Rule 51. (ML impact, M generality) *Avoid placing instructions that use 32-bit immediates which cannot be encoded as a sign-extended 16-bit immediate near each other. Try to schedule μ ops that have no immediate immediately before or after μ ops with 32-bit immediates.*

Address Calculations

Use the addressing modes for computing addresses rather than using the general-purpose computation. Internally, memory reference instructions can have four operands:

- relocatable load-time constant
- immediate constant
- base register
- scaled index register

In the segmented model, a segment register may constitute an additional operand in the linear address calculation. In many cases, several integer instructions can be eliminated by fully using the operands of memory references.

Clearing Registers

Pentium 4 processor provides special support to `xor`, `sub`, or `pxor` operations when executed within the same register. This recognizes that clearing a register does not depend on the old value of the register. The `xorps` and `xorpd` instructions do not have this special support. They cannot be used to break dependence chains.

Assembly/Compiler Coding Rule 52. (M impact, ML generality) Use `xor`, `sub`, or `pxor` to set a register to 0, or to break a false dependence chain resulting from re-use of registers. In contexts where the condition codes must be preserved, move 0 into the register instead. This requires more code space than using `xor` and `sub`, but avoids setting the condition codes.

Compares

Use `test` when comparing a value in a register with zero. `Test` essentially `ands` the operands together without writing to a destination register. `Test` is preferred over `and` because `and` produces an extra result register. `Test` is better than `cmp . . . , 0` because the instruction size is smaller.

Use `test` when comparing the result of a logical `and` with an immediate constant for equality or inequality if the register is `eax` for cases such as:

```
if (avar & 8) { }
```

The `test` instruction can also be used to detect rollover of modulo a power of 2. For example, the C code:

```
if ( (avar % 16) == 0 ) { }
```

can be implemented using:

```
test eax, 0x0F
jnz AfterIf
```

Assembly/Compiler Coding Rule 53. (ML impact, M generality) *Use the `test` instruction instead of `and` when the result of the logical `and` is not used. This saves uops in execution. Use a `test` if a register with itself instead of a `cmp` of the register to zero, this saves the need to encode the zero and saves encoding space. Avoid comparing a constant to a memory operand. It is preferable to load the memory operand and compare the constant to a register.*

Often a produced value must be compared with zero, and then used in a branch. Because most Intel architecture instructions set the condition codes as part of their execution, the compare instruction may be eliminated. Thus the operation can be tested directly by a `jmpcc` instruction. The notable exceptions are `mov` and `leaq`. In these cases, use `test`.

Assembly/Compiler Coding Rule 54. (ML impact, M generality) *Eliminate unnecessary compare with zero instructions by using the appropriate conditional jump instruction when the flags are already set by a preceding arithmetic instruction. If necessary, use a `test` instruction instead of a compare. Be certain that any code transformations made do not introduce problems with overflow.*

Floating Point/SIMD Operands

In initial Pentium 4 processor implementations, the latency of MMX or SIMD floating point register to register moves is significant. This can have implications for register allocation.

Moves that write a portion of a register can introduce unwanted dependences. The `movsd reg, reg` instruction writes only the bottom 64 bits of a register, not to all 128 bits. This introduces a dependence on the preceding instruction that produces the upper 64 bits (even if those bits are not longer wanted). The dependence inhibits register renaming, and thereby reduces parallelism.

Use `movapd` as an alternative; it writes all 128 bits. Even though this instruction has a longer latency, the μ ops for `movapd` use a different execution port and this port is more likely to be free. The change can impact performance. There may be exceptional cases where the latency matters more than the dependence or the execution port.

Assembly/Compiler Coding Rule 55. (M impact, ML generality) *Avoid introducing dependences with partial floating point register writes, e.g. from the `movsd xmmreg1, xmmreg2` instruction. Use the `movapd xmmreg1, xmmreg2` instruction instead.*

The `movsd xmmreg, mem` instruction writes all 128 bits and breaks a dependence.

The `movupd` from memory instruction performs two 64-bit loads, but requires additional μ ops to adjust the address and combine the loads into a single register. This same functionality can be obtained using `movsd xmmreg1, mem; movsd xmmreg2, mem+8; unpklpd xmmreg1, xmmreg2`, which uses fewer μ ops and can be packed into the trace cache more effectively. The latter alternative has been found to provide several percent of performance improvement in some cases. Its encoding requires more instruction bytes, but this is seldom an issue for the Pentium 4 processor. The store version of `movupd` is complex and slow, so much so that the sequence with two `movsd` and a `unpkhpd` should always be used.

Assembly/Compiler Coding Rule 56. (ML impact, L generality) *Instead of using `movupd xmmreg1, mem` for a unaligned 128-bit load, use `movsd xmmreg1, mem; movsd xmmreg2, mem+8; unpklpd xmmreg1, xmmreg2`. If the additional register is not available, then use `movsd xmmreg1, mem; movhpd xmmreg1, mem+8`.*

Assembly/Compiler Coding Rule 57. (M impact, ML generality) *Instead of using `movupd mem, xmmreg1` for a store, use `movsd mem, xmmreg1; unpkhpd xmmreg1, xmmreg1; movsd mem+8, xmmreg1` instead.*

Prolog Sequences

Assembly/Compiler Coding Rule 58. (M impact, MH generality) *In routines that do not need a frame pointer and that do not have called routines that modify ESP, use ESP as the base register to free up EBP. This optimization does not apply in the following cases: a routine is called that leaves ESP modified upon return, for example, `alloca`; routines that rely on EBP for structured or C++ style exception handling; routines that use `setjmp` and `longjmp`; routines that use EBP to align the local stack on an 8- or 16-byte boundary; and routines that rely on EBP debugging.*

If you are not using the 32-bit flat model, remember that EBP cannot be used as a general purpose base register because it references the stack segment.

Code Sequences that Operate on Memory Operands

Careful management of memory operands can improve performance. Instructions of the form “OP REG, MEM” can reduce register pressure by taking advantage of scratch registers that are not available to the compiler.

Assembly/Compiler Coding Rule 59. (M impact, ML generality) *For arithmetic or logical operations that have their source operand in memory and the destination operand is in a register, attempt a strategy that initially loads the memory operand to a register followed by a register to register ALU operation. Next, attempt to remove redundant loads by identifying loads from the same memory location. Finally, combine the remaining loads with their corresponding ALU operations.*

The recommended strategy follows:

1. Initially, operate on register operands and use explicit load and store instructions, minimizing the number of memory accesses by merging redundant loads.
2. In a subsequent pass, free up the registers that contain the operands that were in memory for other uses by replacing any detected code sequence of the form shown in Example 2-25 with OP REG2, MEM1.

Example 2-25 Recombining LOAD/OP Code into REG, MEM Form

```
LOAD reg1, mem1
... code that does not write to reg1...
OP reg2, reg1
... code that does not use reg1 ...
```

Using memory as a destination operand may further reduce register pressure at the slight risk of making trace cache packing more difficult.

On the Pentium 4 processor, the sequence of loading a value from memory into a register and adding the results in a register to memory is faster than the alternate sequence of adding a value from memory to a register and storing the results in a register to memory. The first sequence also uses one less μop than the latter.

Assembly/Compiler Coding Rule 60. (ML impact, M generality) *Give preference to adding a register to memory (memory is the destination) instead of adding memory to a register. Also, give preference to adding a register to memory over loading the memory, adding two registers and storing the result.*

Assembly/Compiler Coding Rule 61. (M impact, M generality) *When an address of a store is unknown, subsequent loads cannot be scheduled to execute out of order ahead of the store, limiting the out of order execution of the processor. When an address of a store is computed by a potentially long latency operation (such as a load that might miss the data cache) attempt to reorder subsequent loads ahead of the store.*

Instruction Scheduling

Ideally, scheduling or pipelining should be done in a way that optimizes performance across all processor generations. This section presents scheduling rules that can improve the performance of your code on the Pentium 4 processor.

Latencies and Resource Constraints

Assembly/Compiler Coding Rule 62. (M impact, MH generality) *Calculate store addresses as early as possible to avoid having stores block loads.*

Spill Scheduling

The spill scheduling algorithm used by a code generator will be impacted by the Pentium 4 processor memory subsystem. A spill scheduling algorithm is an algorithm that selects what values to spill to memory when there are too many live values to fit in registers. Consider the code in Example 2-26, where it is necessary to spill either A, B, or C.

Example 2-26 Spill Scheduling Example Code

```
LOOP
  C := ...
  B := ...
  A := A + ...
```

For the Pentium 4 processor, using dependence depth information in spill scheduling is even more important than in previous processors. The loop-carried dependence in A makes it especially important that A not be spilled. Not only would a store/load be placed in the dependence chain, but there would also be a data-not-ready stall of the load, costing further cycles.

Assembly/Compiler Coding Rule 63. (H impact, MH generality) *For small loops, placing loop invariants in memory is better than spilling loop-carried dependencies.*

A possibly counter-intuitive result: in such a situation it is better to put loop invariants in memory than in registers, since loop invariants never have a load blocked by store data that is not ready.

Scheduling Rules for the Pentium 4 Processor Decoder

The Pentium 4 and Intel Xeon processors have a single decoder that can decode instructions at the maximum rate of one instruction per clock. Complex instructions must enlist the help of the microcode ROM; see Chapter 1, “IA-32 Intel® Architecture Processor Family Overview” for details.

Because micro-ops are delivered from the trace cache in the common cases, decoding rules are not required.

Scheduling Rules for the Pentium M Processor Decoder

The Pentium M processor has three decoders, but the decoding rules to supply micro-ops at high bandwidth are less stringent than those of the Pentium III processor. This provides an opportunity to build a front-end tracker in the compiler and try to schedule instructions correctly. The decoder limitations are as follows:

- The first decoder is capable of decoding one macroinstruction made up of four or fewer micro-ops in each clock cycle. It can handle any number of bytes up to the maximum of 15. Multiple prefix instructions require additional cycles.
- The two additional decoders can each decode one macroinstruction per clock cycle (assuming the instruction is one micro-op up to seven bytes in length).
- Instructions composed of more than four micro-ops take multiple cycles to decode.

Assembly/Compiler Coding Rule 64. (M impact, M generality) *Avoid putting explicit references to ESP in a sequence of stack operations (POB, PUSH, CALL, RET).*

Vectorization

This section provides a brief summary of optimization issues related to vectorization. Chapters 3, 4 and 5 provide greater detail.

Vectorization is a program transformation which allows special hardware to perform the same operation of multiple data elements at the same time. Successive processor generations have provided vector support through the MMX technology, Streaming SIMD Extensions technology and Streaming SIMD Extensions 2. Vectorization is a special case of SIMD, a term defined in Flynn's architecture taxonomy to denote a Single Instruction stream capable of operating on Multiple

Data elements in parallel. The number of elements which can be operated on in parallel range from four single-precision floating point data elements in Streaming SIMD Extensions and two double-precision floating- point data elements in Streaming SIMD Extensions 2 to sixteen byte operations in a 128-bit register in Streaming SIMD Extensions 2. Thus the vector length ranges from 2 to 16, depending on the instruction extensions used and on the data type.

The Intel C++ Compiler supports vectorization in three ways:

- The compiler may be able to generate SIMD code without intervention from the user.
- The user inserts pragmas to help the compiler realize that it can vectorize the code.
- The user may write SIMD code explicitly using intrinsics and C++ classes.

To help enable the compiler to generate SIMD code

- avoid global pointers
- avoid global variables

These may be less of a problem if all modules are compiled simultaneously, and whole-program optimization is used.

User/Source Coding Rule 16. (H impact, M generality) *Use the smallest possible floating-point or SIMD data type, to enable more parallelism with the use of a (longer) SIMD vector. For example, use single precision instead of double precision where possible.*

User/Source Coding Rule 17. (M impact, ML generality) *Arrange the nesting of loops so that the innermost nesting level is free of inter-iteration dependencies. Especially avoid the case where the store of data in an earlier iteration happens lexically after the load of that data in a future iteration, something which is called a lexically backward dependence.*

The integer part of the SIMD instruction set extensions are primarily targeted for 16-bit operands. Not all of the operators are supported for 32 bits, meaning that some source code will not be able to be vectorized at all unless smaller operands are used.

User/Source Coding Rule 18. (M impact, ML generality) *Avoid the use of conditional branches inside loops and consider using SSE instructions to eliminate branches.*

User/Source Coding Rule 19. (M impact, ML generality) *Keep induction (loop) variables expressions simple.*

Miscellaneous

This section explains separate guidelines that do not belong to any category described above.

NOPs

Code generators generate a no-operation (NOP) to align instructions. The NOPs are recommended for the following operations:

- 1-byte: `xchg EAX, EAX`
- 2-byte: `mov reg, reg`
- 3-byte: `lea reg, 0 (reg)` (8-bit displacement)
- 6-byte: `lea reg, 0 (reg)` (32-bit displacement)

These are all true NOPs, having no effect on the state of the machine except to advance the EIP. Because NOPs require hardware resources to decode and execute, use the least number of NOPs to achieve the desired padding.

The one byte NOP, `xchg EAX,EAX`, has special hardware support. Although it still consumes a μop and its accompanying resources, the dependence upon the old value of `EAX` is removed. Therefore, this μop can be executed at the earliest possible opportunity, reducing the number of outstanding instructions. This is the lowest cost NOP possible.

The other NOPs have no special hardware support. Their input and output registers are interpreted by the hardware. Therefore, a code generator should arrange to use the register containing the oldest value as input, so that the NOP will dispatch and release RS resources at the earliest possible opportunity.

Try to observe the following NOP generation priority:

- Select the smallest number of NOPs and pseudo-NOPs to provide the desired padding.
- Select NOPs that are least likely to execute on slower execution unit clusters.
- Select the register arguments of NOPs to reduce dependencies.

Summary of Rules and Suggestions

To summarize the rules and suggestions specified in this chapter, be reminded that coding recommendations are ranked in importance according to these two criteria:

- Local impact (referred to earlier as “impact”) – the difference that a recommendation makes to performance for a given instance.
- Generality – how frequently such instances occur across all application domains.

Again, understand that this ranking is intentionally very approximate, and can vary depending on coding style, application domain, and other factors. Throughout the chapter you observed references to these criteria using the high, medium and low priorities for each recommendation. In places where there was no priority assigned, the local impact or generality has been determined not to be applicable.

The sections that follow summarize the sets of rules and tuning suggestions referenced in the manual.

User/Source Coding Rules

User/Source Coding Rule 1. (L impact, L generality) *If an indirect branch has two or more common taken targets, and at least one of those targets are correlated with branch history leading up to the branch, then convert the indirect branch into a tree where one or more indirect branches are preceded by conditional branches to those targets. Apply this “peeling” procedure to the common target of an indirect branch that correlates to branch history.* 2-22

User/Source Coding Rule 2. (H impact, M generality) *Pad data structures defined in the source code so that every data element is aligned to a natural operand size address boundary. If the operands are packed in a SIMD instruction, align to the packed element size (64- or 128-bit).* 2-38

User/Source Coding Rule 3. (M impact, L generality) *Beware of false sharing within a cache line (64 bytes) for both Pentium 4, Intel Xeon, and Pentium M processors; and within a sector of 128 bytes on Pentium 4 and Intel Xeon processors.* 2-41

User/Source Coding Rule 4. (H impact, ML generality) *Consider using a special memory allocation library to avoid aliasing.* 2-45

User/Source Coding Rule 5. (M impact, M generality) *When padding variable declarations to avoid aliasing, the greatest benefit comes from avoiding aliasing on second-level cache lines, suggesting an offset of 128 bytes or more.* 2-45

User/Source Coding Rule 6. (H impact, H generality) *Optimization techniques such as blocking, loop interchange, loop skewing and packing are best done by the compiler. Optimize data structures to either fit in one-half of the first-level cache or in the second-level cache; turn on loop optimizations in the compiler to enhance locality for nested loops.* 2-49

User/Source Coding Rule 7. (M impact, ML generality) *If there is a blend of reads and writes on the bus, changing the code to separate these bus transactions into read phases and write phases can help performance. Note, however, that the order of read and write operations on the bus are not the same as they appear in the program.* 2-49

User/Source Coding Rule 8. (M impact, H generality) *Enable the prefetch generation in your compile. Note: As the compiler’s prefetch implementation improves, it is expected that its prefetch insertion will outperform manual*

insertion except for code tuning experts, but this is not always the case. If the compiler does not support software prefetching, intrinsics or inline assembly may be used to manually insert prefetch instructions. 2-53

User/Source Coding Rule 9. (M impact, M generality) *Enable the compiler's use of SSE2 instructions with appropriate switches. 2-54*

User/Source Coding Rule 10. (H impact, ML generality) *Make sure your application stays in range to avoid denormal values, underflows. 2-55*

User/Source Coding Rule 11. (M impact, ML generality) *Do not use double precision unless necessary. Set the precision control (PC) field in the x87 FPU control word to "Single Precision". This allows single precision (32-bit) computation to complete faster on some operations (for example, divides due to early out). However, be careful of introducing more than a total of two values for the floating point control word, or there will be a large performance penalty. See "Floating-point Modes". 2-55*

User/Source Coding Rule 12. (H impact, ML generality) *Use fast float-to-int routines. If coding these routines, use the `cvtts2si`, `cvttsd2si` instructions if coding with Streaming SIMD Extensions 2. 2-55*

User/Source Coding Rule 13. (M impact, ML generality) *Break dependence chains where possible. 2-55*

User/Source Coding Rule 14. (M impact, ML generality) *Usually, math libraries take advantage of the transcendental instructions (for example, `fsin`) when evaluating elementary functions. If there is no critical need to evaluate the transcendental functions using the extended precision of 80 bits, applications should consider alternate, software-based approach, such as look-up-table-based algorithm using interpolation techniques. It is possible to improve transcendental performance with these techniques by choosing the desired numeric precision, the size of the look-up table and taking advantage of the parallelism of the Streaming SIMD Extensions and the Streaming SIMD Extensions 2 instructions. 2-56*

User/Source Coding Rule 15. (H impact, ML generality) *Denormalized floating-point constants should be avoided as much as possible. 2-57*

User/Source Coding Rule 16. (H impact, M generality) *Use the smallest possible floating-point or SIMD data type, to enable more parallelism with the use of a (longer) SIMD vector. For example, use single precision instead of double precision where possible. 2-82*

User/Source Coding Rule 17. (M impact, ML generality) *Arrange the nesting of loops so that the innermost nesting level is free of inter-iteration dependencies. Especially avoid the case where the store of data in an earlier iteration happens lexically after the load of that data in a future iteration, something which is called a lexically backward dependence. 2-83*

User/Source Coding Rule 18. (M impact, ML generality) *Avoid the use of conditional branches inside loops and consider using SSE instructions to eliminate branches. 2-83*

User/Source Coding Rule 19. (M impact, ML generality) *Keep loop induction variables expressions simple. 2-83*

Assembly/Compiler Coding Rules

Assembly/Compiler Coding Rule 1. (MH impact, H generality) *Arrange code to make basic blocks contiguous to eliminate unnecessary branches. 2-14*

Assembly/Compiler Coding Rule 2. (M impact, ML generality) *Use the `setcc` and `cmov` instructions to eliminate unpredictable conditional branches where possible. Do not do this for predictable branches. Do not use these instructions to eliminate all unpredictable conditional branches, because using these instructions will incur execution overhead due to executing both paths of a conditional branch. In addition, converting conditional branches to `cmovs` or `setcc` trades off control flow dependence for data dependence and restricts the capability of the out of order engine. When tuning, note that all IA-32 based processors have very high branch prediction rates. Consistently mispredicted are rare. Use these instructions only if the increase in computation time is less than the expected cost of a mispredicted branch. 2-14*

Assembly/Compiler Coding Rule 3. (M impact, H generality) *Arrange code to be consistent with the static branch prediction algorithm: make the fall-through code following a conditional branch be the likely target for a branch with a forward target, and make the fall-through code following a conditional branch be the unlikely target for a branch with a backward target. 2-17*

Assembly/Compiler Coding Rule 4. (MH impact, MH generality) *Near calls must be matched with near returns, and far calls must be matched with far returns. Pushing the return address on the stack and jumping to the routine to be called is not recommended since it creates a mismatch in calls and returns. 2-20*

Assembly/Compiler Coding Rule 5. (MH impact, MH generality) *Selectively inline a function where doing so decreases code size, or if the function is small and the call site is frequently executed. 2-20*

Assembly/Compiler Coding Rule 6. (H impact, M generality) *Do not inline a function if doing so increases the working set size beyond what will fit in the trace cache. 2-20*

Assembly/Compiler Coding Rule 7. (ML impact, ML generality) *If there are more than 16 nested calls and returns in rapid succession, consider transforming the program, for example, with inline, to reduce the call depth. 2-20*

Assembly/Compiler Coding Rule 8. (ML impact, ML generality) *Favor inlining small functions that contain branches with poor prediction rates. If a branch misprediction results in a RETURN being prematurely predicted as taken, a performance penalty may be incurred. 2-20*

Assembly/Compiler Coding Rule 9. (L impact, L generality) *If the last statement in a function is a call to another function, consider converting the call to a jump. This will save the call/ return overhead as well as an entry in the return stack buffer. 2-20*

Assembly/Compiler Coding Rule 10. (M impact, L generality) *Do not put more than four branches in 16-byte chunks. 2-20*

Assembly/Compiler Coding Rule 11. (M impact, L generality) *Do not put more than two end loop branches in a 16-byte chunk. 2-21*

Assembly/Compiler Coding Rule 12. (M impact, MH generality) *If the average number of total iterations is less than or equal to 100, use a forward branch to exit the loop. 2-21*

Assembly/Compiler Coding Rule 13. (M impact, L generality) *When indirect branches are present, try to put the most likely target of an indirect branch immediately following that indirect branch. Alternatively, if indirect branches are common but they cannot be predicted by branch prediction hardware, then follow the indirect branch with a UD2 instruction, which will stop the processor from decoding down the fall-through path. 2-21*

Assembly/Compiler Coding Rule 14. (H impact, M generality) *Unroll small loops until the overhead of the branch and the induction variable accounts, generally, for less than about 10% of the execution time of the loop. 2-25*

Assembly/Compiler Coding Rule 15. (H impact, M generality) *Avoid unrolling loops excessively, as this may thrash the trace cache or instruction cache. 2-25*

Assembly/Compiler Coding Rule 16. (M impact, M generality) *Unroll loops that are frequently executed and that have a predictable number of iterations to reduce the number of iterations to 16 or fewer, unless this increases code size so that the working set no longer fits in the trace cache. If the loop body contains more than one conditional branch, then unroll so that the number of iterations is 16/(# conditional branches).* 2-25

Assembly/Compiler Coding Rule 17. (H impact, H generality) *Align data on natural operand size address boundaries. If the data will be accessed with vector instruction loads and stores, align the data on 16-byte boundaries.* 2-28

Assembly/Compiler Coding Rule 18. (H impact, M generality) *Pass parameters in registers instead of on the stack where possible. Passing arguments on the stack is a case of store followed by a reload. While this sequence is optimized in IA-32 processors by providing the value to the load directly from the memory order buffer without the need to access the data cache, floating point values incur a significant latency in forwarding. Passing floating point argument in (preferably XMM) registers should save this long latency operation.* 2-31

Assembly/Compiler Coding Rule 19. (H impact, M generality) *A load that forwards from a store must have the same address start point and therefore the same alignment as the store data.* 2-32

Assembly/Compiler Coding Rule 20. (H impact, M generality) *The data of a load which is forwarded from a store must be completely contained within the store data.* 2-32

Assembly/Compiler Coding Rule 21. (H impact, ML generality) *If it is necessary to extract a non-aligned portion of stored data, read out the smallest aligned portion that completely contains the data and shift/mask the data as necessary.* 2-33

Assembly/Compiler Coding Rule 22. (MH impact, ML generality) *Avoid several small loads after large stores to the same area of memory by using a single large read and register copies as needed.* 2-33

Assembly/Compiler Coding Rule 23. (H impact, MH generality)

Where it is possible to do so without incurring other penalties, prioritize the allocation of variables to registers, as in register allocation and for parameter passing to minimize the likelihood and impact of store-forwarding problems. Try not to store-forward data generated from a long latency instruction, e.g. `mul`, `div`. Avoid store-forwarding data for variables with the shortest store-load distance. Avoid store-forwarding data for variables with many and/or long dependence chains, and especially avoid including a store forward on a loop-carried dependence chain. 2-37

Assembly/Compiler Coding Rule 24. (H impact, M generality) *Try to arrange data structures such that they permit sequential access. 2-40*

Assembly/Compiler Coding Rule 25. (H impact, M generality) *If 64-bit data is ever passed as a parameter or allocated on the stack, make sure that the stack is aligned to an 8-byte boundary. 2-41*

Assembly/Compiler Coding Rule 26. (H impact, MH generality) *Lay out data or order computation to avoid having cache lines that have linear addresses that are a multiple of 64 KB apart in the same working set. Avoid having more than 4 cache lines that are some multiple of 2 KB apart in the same first-level cache working set, and avoid having more than eight cache lines that are some multiple of 4 KB apart in the same first-level cache working set. Avoid having more than 8 cache lines that are some multiple of 64 KB apart in the same second-level cache working set. Avoid having a store followed by a non-dependent load with addresses that differ by a multiple of 4 KB. 2-44*

Assembly/Compiler Coding Rule 27. (M impact, L generality) *If (hopefully read-only) data must occur on the same page as code, avoid placing it immediately after an indirect jump. For example, follow an indirect jump with its mostly likely target, and place the data after an unconditional branch. 2-46*

Assembly/Compiler Coding Rule 28. (H impact, L generality) *Always put code and data on separate pages. Avoid self-modifying code wherever possible. If code is to be modified, try to do it all at once and make sure the code that performs the modifications and the code being modified are on separate 4 KB pages or on separate aligned 1 KB subpages. 2-46*

Assembly/Compiler Coding Rule 29. (H impact, L generality) *If an inner loop writes to more than four arrays, (four distinct cache lines), apply loop fission to break up the body of the loop such that only four arrays are being written to in each iteration of each of the resulting loops.* 2-47

Assembly/Compiler Coding Rule 30. (M impact, H generality) *All branch targets should be 16-byte aligned.* 2-54

Assembly/Compiler Coding Rule 31. (M impact, H generality) *If the body of a conditional is not likely to be executed, it should be placed in another part of the program. If it is highly unlikely to be executed and code locality is an issue, the body of the conditional should be placed on a different code page.* 2-54

Assembly/Compiler Coding Rule 32. (H impact, M generality) *Minimize changes to bits 8-12 of the floating point control word. Changing among more than two values (each value being a combination of these bits: precision, rounding and infinity control, and the rest of bits in FCW) leads to delays that are on the order of the pipeline depth.* 2-60

Assembly/Compiler Coding Rule 33. (H impact, L generality) *Minimize the number of changes to the rounding mode. Do not use changes in the rounding mode to implement the floor and ceiling functions if this involves a total of more than two values of the set of rounding, precision and infinity bits.* 2-63

Assembly/Compiler Coding Rule 34. (H impact, L generality) *Minimize the number of changes to the precision mode.* 2-64

Assembly/Compiler Coding Rule 35. (M impact, M generality) *Use `fxch` only where necessary to increase the effective name space.* 2-65

Assembly/Compiler Coding Rule 36. (M impact, M generality) *Use Streaming SIMD Extensions 2 or Streaming SIMD Extensions unless you need an x87 feature. Most SSE2 arithmetic operations have shorter latency than their X87 counterparts and they eliminate the overhead associated with the management of the X87 register stack.* 2-66

Assembly/Compiler Coding Rule 37. (M impact, L generality) *Try to use 32-bit operands rather than 16-bit operands for `fld`. However, do not do so at the expense of introducing a store forwarding problem by writing the two halves of the 32-bit memory operand separately.* 2-67

Assembly/Compiler Coding Rule 38. (M impact, H generality) *Choose instructions with shorter latencies and fewer micro-ops. Favor single micro-operation instructions.* 2-68

Assembly/Compiler Coding Rule 39. (M impact, L generality) *Avoid prefixes, especially multiple non-0F-prefixed opcodes.* 2-68

Assembly/Compiler Coding Rule 40. (M impact, L generality) *Do not use many segment registers.* 2-68

Assembly/Compiler Coding Rule 41. (ML impact, M generality) *Avoid using complex instructions (for example, `enter`, `leave`, or `loop`) that generally have more than four μ ops and require multiple cycles to decode. Use sequences of simple instructions instead.* 2-69

Assembly/Compiler Coding Rule 42. (ML impact, M generality) *If a `lea` instruction using the scaled index is on the critical path, a sequence with `adds` may be better. If code density and bandwidth out of the trace cache are the critical factor, then use the `lea` instruction.* 2-70

Assembly/Compiler Coding Rule 43. (M impact, H generality) *`inc` and `dec` instructions should be replaced with an `add` or `sub` instruction, because `add` and `sub` overwrite all flags, whereas `inc` and `dec` do not, therefore creating false dependencies on earlier instructions that set the flags.* 2-70

Assembly/Compiler Coding Rule 44. (ML impact, L generality) *Avoid `rotate` by register or `rotate` by immediate instructions. If possible, replace with a `rotate` by 1 instruction.* 2-70

Assembly/Compiler Coding Rule 45. (M impact, MH generality) *Replace integer multiplies by a small constant with two or more `add` and `lea` instructions, especially when these multiplications is part of a dependence chain.* 2-71

Assembly/Compiler Coding Rule 46. (ML impact, L generality) *Use `cdw` or `cdq` instead of a `shift` and a `move`. Replace these with an `xor` whenever `AX` or `EAX` is known to be positive.* 2-71

Assembly/Compiler Coding Rule 47. (ML impact, L generality) *Use simple instructions that are less than eight bytes in length. 2-73*

Assembly/Compiler Coding Rule 48. (M impact, MH generality) *Avoid using prefixes to change the size of immediate and displacement. 2-73*

Assembly/Compiler Coding Rule 49. (M impact, MH generality) *Break dependences on portions of registers between instructions by operating on 32-bit registers instead of partial registers. For moves, this can be accomplished with 32-bit moves or by using `movzx`. 2-73*

Assembly/Compiler Coding Rule 50. (M impact, M generality) *Try to use zero extension or operate on 32-bit operands instead of using moves with sign extension. 2-74*

Assembly/Compiler Coding Rule 51. (ML impact, M generality) *Avoid placing instructions that use 32-bit immediates which cannot be encoded as a sign-extended 16-bit immediate near each other. Try to schedule `µops` that have no immediate immediately before or after `µops` with 32-bit immediates. 2-74*

Assembly/Compiler Coding Rule 52. (M impact, ML generality) *Use `xor`, `sub`, or `pxor` to set a register to 0, or to break a false dependence chain resulting from re-use of registers. In contexts where the condition codes must be preserved, move 0 into the register instead. This requires more code space than using `xor` and `sub`, but avoids setting the condition codes. 2-75*

Assembly/Compiler Coding Rule 53. (ML impact, M generality) *Use the `test` instruction instead of `and` when the result of the logical `and` is not used. This saves `uops` in execution. Use a `test` if a register with itself instead of a `cmp` of the register to zero, this saves the need to encode the zero and saves encoding space. Avoid comparing a constant to a memory operand. It is preferable to load the memory operand and compare the constant to a register. 2-76*

Assembly/Compiler Coding Rule 54. (ML impact, M generality) *Eliminate unnecessary compare with zero instructions by using the appropriate conditional jump instruction when the flags are already set by*

a preceding arithmetic instruction. If necessary, use a test instruction instead of a compare. Be certain that any code transformations made do not introduce problems with overflow. 2-76

Assembly/Compiler Coding Rule 55. (M impact, ML generality) *Avoid introducing dependences with partial floating point register writes, e.g. from the `movsd xmmreg1, xmmreg2` instruction. Use the `movapd xmmreg1, xmmreg2` instruction instead. 2-77*

Assembly/Compiler Coding Rule 56. (ML impact, L generality) *Instead of using `movupd xmmreg1, mem` for a unaligned 128-bit load, use `movsd xmmreg1, mem; movsd xmmreg2, mem+8; unpcplpd xmmreg1, xmmreg2`. If the additional register is not available, then use `movsd xmmreg1, mem; movhpd xmmreg1, mem+8`. 2-77*

Assembly/Compiler Coding Rule 57. (M impact, ML generality) *Instead of using `movupd mem, xmmreg1` for a store, use `movsd mem, xmmreg1; unpcxhpd xmmreg1, xmmreg1; movsd mem+8, xmmreg1` instead. 2-77*

Assembly/Compiler Coding Rule 58. (M impact, MH generality) *In routines that do not need a frame pointer and that do not have called routines that modify ESP, use ESP as the base register to free up EBP. This optimization does not apply in the following cases: a routine is called that leaves ESP modified upon return, for example, `alloca`; routines that rely on EBP for structured or C++ style exception handling; routines that use `setjmp` and `longjmp`; routines that use EBP to align the local stack on an 8- or 16-byte boundary; and routines that rely on EBP debugging. 2-78*

Assembly/Compiler Coding Rule 59. (M impact, ML generality) *For arithmetic or logical operations that have their source operand in memory and the destination operand is in a register, attempt a strategy that initially loads the memory operand to a register followed by a register to register ALU operation. Next, attempt to remove redundant loads by identifying loads from the same memory location. Finally, combine the remaining loads with their corresponding ALU operations. 2-78*

Assembly/Compiler Coding Rule 60. (ML impact, M generality) Give preference to adding a register to memory (memory is the destination) instead of adding memory to a register. Also, give preference to adding a register to memory over loading the memory, adding two registers and storing the result. 2-79

Assembly/Compiler Coding Rule 61. (M impact, M generality) When an address of a store is unknown, subsequent loads cannot be scheduled to execute out of order ahead of the store, limiting the out of order execution of the processor. When an address of a store is computed by a potentially long latency operation (such as a load that might miss the data cache) attempt to reorder subsequent loads ahead of the store. 2-79

Assembly/Compiler Coding Rule 62. (M impact, MH generality) Calculate store addresses as early as possible to avoid having stores block loads. 2-80

Assembly/Compiler Coding Rule 63. (H impact, MH generality) For small loops, placing loop invariants in memory is better than spilling loop-carried dependencies. 2-80

Assembly/Compiler Coding Rule 64. (M impact, M generality) Avoid putting explicit references to ESP in a sequence of stack operations (POB, PUSH, CALL, RET). 2-81

Tuning Suggestions

Tuning Suggestion 1. Rarely, a performance problem may be noted due to executing data on a code page as instructions. The only condition where this is likely to happen is following an indirect branch that is not resident in the trace cache. If a performance problem is clearly due to this problem, try moving the data elsewhere, or inserting an illegal opcode or a pause instruction immediately following the indirect branch. The latter two alternative may degrade performance in some circumstances. 2-46

Tuning Suggestion 2. If a load is found to miss frequently, insert a prefetch before it or, if issue bandwidth is a concern, move the load up to execute earlier. 2-53

Intel Pentium 4, Intel Xeon and Pentium M processors include support for Streaming SIMD Extensions 2, Streaming SIMD Extensions technology, and MMX technology. These single-instruction, multiple-data (SIMD) technologies enable the development of advanced multimedia, signal processing, and modeling applications.

To take advantage of the performance opportunities presented by these new capabilities, take into consideration the following:

- Ensure that the processor supports MMX technology, Streaming SIMD Extensions (SSE), and Streaming SIMD Extensions 2 (SSE2).
- Ensure that the operating system supports MMX technology and SSE (OS support for SSE2 is the same as OS support for SSE).
- Employ all of the optimization and scheduling strategies described in this book.
- Use stack and data alignment techniques to keep data properly aligned for efficient memory use.
- Utilize the cacheability instructions offered by SSE and SSE2.

Checking for Processor Support of SIMD Technologies

This section shows how to check whether a processor supports MMX technology, SSE, or SSE2.

SIMD technology can be included in your application in three ways:

1. Check for the SIMD technology during installation. If the desired SIMD technology is available, the appropriate DLLs can be installed.
2. Check for the SIMD technology during program execution and install the proper DLLs at runtime. This is effective for programs that may be executed on different machines.
3. Create a “fat” binary that includes multiple versions of routines; versions that use SIMD technology and versions that do not. Check for SIMD technology during program execution and run the appropriate versions of the routines. This is especially effective for programs that may be executed on different machines.

Checking for MMX Technology Support

To check if MMX technology is available on your system, use `cpuid` to and check the feature flags in the `edx` register. If `cpuid` returns bit 23 set to 1 in the feature flags, the processor supports MMX technology.

Use the code segment in Example 3-1 to test for the existence of MMX technology.

Example 3-1 Identification of MMX Technology with `cpuid`

```
...identify existence of cpuid instruction
...
... ; identify signature is genuine intel
...
mov eax, 1 ; request for feature flags
cpuid ; 0Fh, 0A2h cpuid instruction
test edx, 00800000h ; is MMX technology bit (bit
; 23) in feature flags equal to 1
jnz Found
```

For more information on `cpuid` see, *Intel Processor Identification with CPUID Instruction*, order number 241618.

Checking for Streaming SIMD Extensions Support

Checking for support of Streaming SIMD Extensions (SSE) on your processor is like checking for MMX technology. However, you must also check whether your operating system (OS) supports SSE. This is because the OS needs to manage saving and restoring the state introduced by SSE for your application to properly function.

To check whether your system supports SSE, follow these steps:

1. Check that your processor supports the `cpuid` instruction.
2. Check the feature bits of `cpuid` for SSE existence.
3. Check for OS support for SSE.

Example 3-2 shows how to find the SSE feature bit (bit 25) in the `cpuid` feature flags.

Example 3-2 Identification of SSE with `cpuid`

```
...identify existence of cpuid instruction
...                               ; identify signature is genuine intel
mov eax, 1                       ; request for feature flags
cpuid                             ; 0Fh, 0A2h cpuid instruction
test EDX, 002000000h             ; bit 25 in feature flags equal to 1
jnz                               Found
```

To find out whether the operating system supports SSE, execute an SSE instruction and trap for an exception if one occurs. Catching the exception in a simple try/except clause (using structured exception handling in C++) and checking whether the exception code is an invalid opcode will give you the answer. See Example 3-3.

Example 3-3 Identification of SSE by the OS

```
bool OSSupportCheck() {
    _try {
        __asm xorps xmm0, xmm0 ;Streaming SIMD Extension
    }
    _except(EXCEPTION_EXECUTE_HANDLER) {
        if (_exception_code() == STATUS_ILLEGAL_INSTRUCTION)
            /* SSE not supported */
            return (false);
    }
    /* SSE are supported by OS */
    return (true);
}
```

Checking for Streaming SIMD Extensions 2 Support

Checking for support of SSE2 is like checking for SSE support. You must also check whether your operating system (OS) supports SSE. The OS requirements for SSE2 Support are the same as the requirements for SSE.

To check whether your system supports SSE2, follow these steps:

1. Check that your processor has the `cpuid` instruction.
2. Check the feature bits of `cpuid` for SSE2 technology existence.
3. Check for OS support for SSE.

Example 3-2 shows how to find the SSE2 feature bit (bit 25) in the `cpuid` feature flags.

Example 3-4 Identification of SSE2 with `cpuid`

```
...identify existence of cpuid instruction
...                ; identify signature is genuine intel
mov eax, 1          ; request for feature flags
cpuid              ; 0Fh, 0A2h cpuid instruction
test EDX, 00400000h ; bit 26 in feature flags equal to 1
jnz                Found
```

SSE2 requires the same support from the operating system as SSE. To find out whether the operating system supports SSE2, execute an SSE2 instruction and trap for an exception if one occurs. Catching the exception in a simple try/except clause (using structured exception handling in C++) and checking whether the exception code is an invalid opcode will give you the answer. See Example 3-3.

Example 3-5 Identification of SSE2 by the OS

```
bool OSSupportCheck() {
    _try {
        __asm xorpd xmm0, xmm0 ; SSE2}
    _except(EXCEPTION_EXECUTE_HANDLER) {
        if _exception_code()==STATUS_ILLEGAL_INSTRUCTION)
            /* SSE2not supported */
            return (false);
    }
    /* SSE2 are supported by OS */
    return (true);
}
```

Considerations for Code Conversion to SIMD Programming

The VTune Performance Enhancement Environment CD provides tools to aid in the evaluation and tuning. But before implementing them, you need answers to the following questions:

1. Will the current code benefit by using MMX technology, Streaming SIMD Extensions, or Streaming SIMD Extensions 2?
2. Is this code integer or floating-point?
3. What integer word size or floating-point precision is needed?
4. What coding techniques should I use?
5. What guidelines do I need to follow?
6. How should I arrange and align the datatypes?

Figure 3-1 provides a flowchart for the process of converting code to MMX technology, Streaming SIMD Extensions, or Streaming SIMD Extensions 2.

Figure 3-1 Converting to Streaming SIMD Extensions Chart

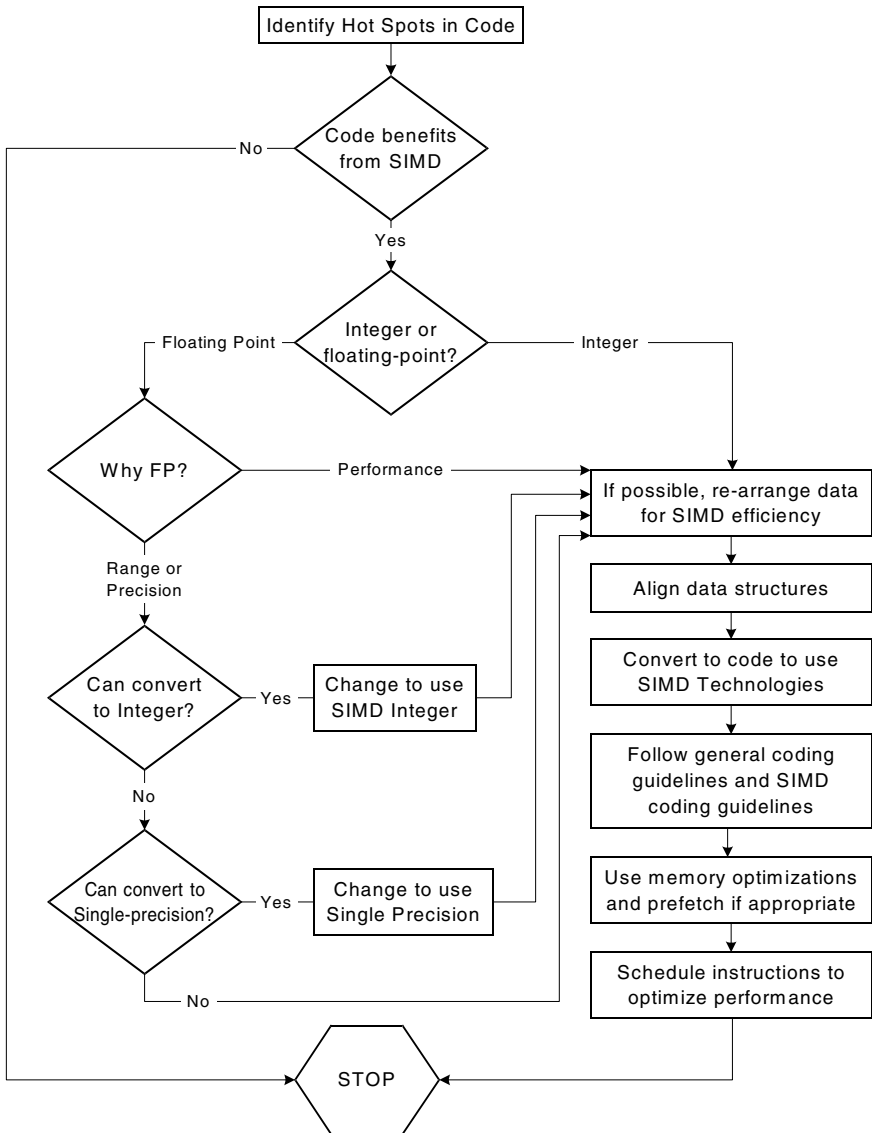

OM15156

To use any of the SIMD technologies optimally, you must evaluate the following situations in your code:

- fragments that are computationally intensive
- fragments that are executed often enough to have an impact on performance
- fragments that require integer computations with little data-dependent control flow
- fragments that require floating-point computations
- fragments that require help in using the cache hierarchy efficiently.

Identifying Hot Spots

To optimize performance, use the VTune Performance Analyzer to find sections of code that occupy most of the computation time. Such sections are called the hotspots. For details on the VTune analyzer, see “Application Performance Tools” in Appendix A.

The VTune analyzer provides a hotspots view of a specific module to help you identify sections in your code that take the most CPU time and that have potential performance problems. For more explanation, see section “Sampling” in Appendix A, which includes an example of a hotspots report. The hotspots view helps you identify sections in your code that take the most CPU time and that have potential performance problems.

The VTune analyzer enables you to change the view to show hotspots by memory location, functions, classes, or source files. You can double-click on a hotspot and open the source or assembly view for the hotspot and see more detailed information about the performance of each instruction in the hotspot.

The VTune analyzer offers focused analysis and performance data at all levels of your source code and can also provide advice at the assembly language level. The code coach analyzes and identifies opportunities for better performance of C/C++, Fortran and Java* programs, and suggests

specific optimizations. Where appropriate, the coach displays pseudo-code to suggest the use of highly optimized intrinsics and functions in the Intel® Performance Library Suite. Because VTune analyzer is designed specifically for all of the Intel architecture (IA)-based processors, including the Pentium 4 processor, it can offer these detailed approaches to working with IA. See “Code Optimization Options” in Appendix A for more details and example of a code coach advice.

Determine If Code Benefits by Conversion to SIMD Execution

Identifying code that benefits by using SIMD technologies can be time-consuming and difficult. Likely candidates for conversion are applications that are highly computation intensive, such as the following:

- speech compression algorithms and filters
- speech recognition algorithms
- video display and capture routines
- rendering routines
- 3D graphics (geometry)
- image and video processing algorithms
- spatial (3D) audio
- physical modeling (graphics, CAD)
- workstation applications
- encryption algorithms

Generally, good candidate code is code that contains small-sized repetitive loops that operate on sequential arrays of integers of 8 or 16 bits for MMX technology, single-precision 32-bit floating-point data for SSE technology, or double precision 64-bit floating-point data for SSE2 (integer and floating-point data items should be sequential in memory).

The repetitiveness of these loops incurs costly application processing time. However, these routines have potential for increased performance when you convert them to use one of the SIMD technologies.

Once you identify your opportunities for using a SIMD technology, you must evaluate what should be done to determine whether the current algorithm or a modified one will ensure the best performance.

Coding Techniques

The SIMD features of SSE2, SSE, and MMX technology require new methods of coding algorithms. One of them is vectorization.

Vectorization is the process of transforming sequentially-executing, or scalar, code into code that can execute in parallel, taking advantage of the SIMD architecture parallelism. This section discusses the coding techniques available for an application to make use of the SIMD architecture.

To vectorize your code and thus take advantage of the SIMD architecture, do the following:

- Determine if the memory accesses have dependencies that would prevent parallel execution.
- “Strip-mine” the loop to reduce the iteration count by the length of the SIMD operations (for example, four for single-precision floating-point SIMD, eight for 16-bit integer SIMD on the XMM registers).
- Re-code the loop with the SIMD instructions.

Each of these actions is discussed in detail in the subsequent sections of this chapter. These sections also discuss enabling automatic vectorization via the Intel C++ Compiler.

Coding Methodologies

Software developers need to compare the performance improvement that can be obtained from assembly code versus the cost of those improvements. Programming directly in assembly language for a target platform may produce the required performance gain, however, assembly code is not portable between processor architectures and is expensive to write and maintain.

Performance objectives can be met by taking advantage of the different SIMD technologies using high-level languages as well as assembly. The new C/C++ language extensions designed specifically for SSE2, SSE, and MMX technology help make this possible.

Figure 3-2 illustrates the trade-offs involved in the performance of hand-coded assembly versus the ease of programming and portability.

Figure 3-2 Hand-Coded Assembly and High-Level Compiler Performance Trade-offs

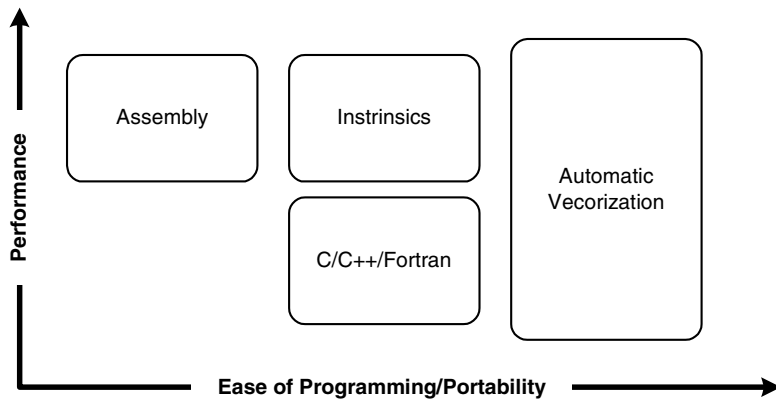

The examples that follow illustrate the use of coding adjustments to enable the algorithm to benefit from the SSE. The same techniques may be used for single-precision floating-point, double-precision floating-point, and integer data under SSE2, SSE, and MMX technology.

As a basis for the usage model discussed in this section, consider a simple loop shown in Example 3-6.

Example 3-6 Simple Four-Iteration Loop

```
void add(float *a, float *b, float *c)
{
    int i;
    for (i = 0; i < 4; i++) {
        c[i] = a[i] + b[i];
    }
}
```

Note that the loop runs for only four iterations. This allows a simple replacement of the code with Streaming SIMD Extensions.

For the optimal use of the Streaming SIMD Extensions that need data alignment on the 16-byte boundary, all examples in this chapter assume that the arrays passed to the routine, *a*, *b*, *c*, are aligned to 16-byte boundaries by a calling routine. For the methods to ensure this alignment, please refer to the application notes for the Pentium 4 processor available at <http://developer.intel.com>.

The sections that follow provide details on the coding methodologies: inlined assembly, intrinsics, C++ vector classes, and automatic vectorization.

Assembly

Key loops can be coded directly in assembly language using an assembler or by using inlined assembly (C-asm) in C/C++ code. The Intel compiler or assembler recognize the new instructions and registers, then directly generate the corresponding code. This model offers the opportunity for attaining greatest performance, but this performance is not portable across the different processor architectures.

Example 3-7 shows the Streaming SIMD Extensions inlined assembly encoding.

Example 3-7 Streaming SIMD Extensions Using Inlined Assembly Encoding

```
void add(float *a, float *b, float *c)
{
    __asm {
        mov     eax, a
        mov     edx, b
        mov     ecx, c

        movaps  xmm0, XMMWORD PTR [eax]
        addps   xmm0, XMMWORD PTR [edx]
        movaps  XMMWORD PTR [ecx], xmm0
    }
}
```

Intrinsics

Intrinsics provide the access to the ISA functionality using C/C++ style coding instead of assembly language. Intel has defined three sets of intrinsic functions that are implemented in the Intel® C++ Compiler to support the MMX technology, Streaming SIMD Extensions and Streaming SIMD Extensions 2. Four new C data types, representing 64-bit and 128-bit objects are used as the operands of these intrinsic functions. `__m64` is used for MMX integer SIMD, `__m128` is used for single-precision floating-point SIMD, `__m128i` is used for Streaming

SIMD Extensions 2 integer SIMD and `__m128d` is used for double precision floating-point SIMD. These types enable the programmer to choose the implementation of an algorithm directly, while allowing the compiler to perform register allocation and instruction scheduling where possible. These intrinsics are portable among all Intel architecture-based processors supported by a compiler. The use of intrinsics allows you to obtain performance close to the levels achievable with assembly. The cost of writing and maintaining programs with intrinsics is considerably less. For a detailed description of the intrinsics and their use, refer to the *Intel C++ Compiler User's Guide*.

Example 3-8 shows the loop from Example 3-4 using intrinsics.

Example 3-8 Simple Four-Iteration Loop Coded with Intrinsics

```
#include <xmmintrin.h>
void add(float *a, float *b, float *c)
{
    __m128 t0, t1;
    t0 = _mm_load_ps(a);
    t1 = _mm_load_ps(b);
    t0 = _mm_add_ps(t0, t1);
    _mm_store_ps(c, t0);
}
```

The intrinsics map one-to-one with actual Streaming SIMD Extensions assembly code. The `xmmintrin.h` header file in which the prototypes for the intrinsics are defined is part of the Intel C++ Compiler included with the VTune Performance Enhancement Environment CD.

Intrinsics are also defined for the MMX technology ISA. These are based on the `__m64` data type to represent the contents of an `mm` register. You can specify values in bytes, short integers, 32-bit values, or as a 64-bit object.

The intrinsic data types, however, are not a basic ANSI C data type, and therefore you must observe the following usage restrictions:

- Use intrinsic data types only on the left-hand side of an assignment as a return value or as a parameter. You cannot use it with other arithmetic expressions (for example, “+”, “>>”).
- Use intrinsic data type objects in aggregates, such as unions to access the byte elements and structures; the address of an `__m64` object may be also used.
- Use intrinsic data type data only with the MMX technology intrinsics described in this guide.

For complete details of the hardware instructions, see the *Intel Architecture MMX Technology Programmer's Reference Manual*. For descriptions of data types, see the *Intel Architecture Software Developer's Manual, Volume 2: Instruction Set Reference Manual*.

Classes

A set of C++ classes has been defined and available in Intel C++ Compiler to provide both a higher-level abstraction and more flexibility for programming with MMX technology, Streaming SIMD Extensions and Streaming SIMD Extensions 2. These classes provide an easy-to-use and flexible interface to the intrinsic functions, allowing developers to write more natural C++ code without worrying about which intrinsic or assembly language instruction to use for a given operation. Since the intrinsic functions underlie the implementation of these C++ classes, the performance of applications using this methodology can approach that of one using the intrinsics. Further details on the use of these classes can be found in the *Intel C++ Class Libraries for SIMD Operations User's Guide*, order number 693500.

Example 3-9 shows the C++ code using a vector class library. The example assumes the arrays passed to the routine are already aligned to 16-byte boundaries.

Example 3-9 C++ Code Using the Vector Classes

```
#include <fvec.h>
void add(float *a, float *b, float *c)
{
    F32vec4 *av=(F32vec4 *) a;
    F32vec4 *bv=(F32vec4 *) b;
    F32vec4 *cv=(F32vec4 *) c;
    *cv=*av + *bv;
}
```

Here, `fvec.h` is the class definition file and `F32vec4` is the class representing an array of four floats. The “+” and “=” operators are overloaded so that the actual Streaming SIMD Extensions implementation in the previous example is abstracted out, or hidden, from the developer. Note how much more this resembles the original code, allowing for simpler and faster programming.

Again, the example is assuming the arrays, passed to the routine, are already aligned to 16-byte boundary.

Automatic Vectorization

The Intel C++ Compiler provides an optimization mechanism by which simple loops, such as in Example 3-6 can be automatically vectorized, or converted into Streaming SIMD Extensions code. The compiler uses similar techniques to those used by a programmer to identify whether a loop is suitable for conversion to SIMD. This involves determining whether the following might prevent vectorization:

- the layout of the loop and the data structures used
- dependencies amongst the data accesses in each iteration and across iterations

Once the compiler has made such a determination, it can generate vectorized code for the loop, allowing the application to use the SIMD instructions.

The caveat to this is that only certain types of loops can be automatically vectorized, and in most cases user interaction with the compiler is needed to fully enable this.

Example 3-10 shows the code for automatic vectorization for the simple four-iteration loop (from Example 3-6).

Example 3-10 Automatic Vectorization for a Simple Loop

```
void add (float *restrict a,
         float *restrict b,
         float *restrict c)
{
    int i;
    for (i = 0; i < 4; i++) {
        c[i] = a[i] + b[i];
    }
}
```

Compile this code using the `-Qax` and `-Qrestrict` switches of the Intel C++ Compiler, version 4.0 or later.

The `restrict` qualifier in the argument list is necessary to let the compiler know that there are no other aliases to the memory to which the pointers point. In other words, the pointer for which it is used, provides the only means of accessing the memory in question in the scope in which the pointers live. Without this qualifier, the compiler will not vectorize the loop because it cannot ascertain whether the array references in the loop overlap, and without this information, generating vectorized code is unsafe.

Refer to the *Intel® C++ Compiler User's Guide*, for more details on the use of automatic vectorization.

Stack and Data Alignment

To get the most performance out of code written for SIMD technologies data should be formatted in memory according to the guidelines described in this section. Assembly code with an unaligned accesses is a lot slower than an aligned access.

Alignment and Contiguity of Data Access Patterns

The new 64-bit packed data types defined by MMX technology, and the 128-bit packed data types for Streaming SIMD Extensions and Streaming SIMD Extensions 2 create more potential for misaligned data accesses. The data access patterns of many algorithms are inherently misaligned when using MMX technology and Streaming SIMD Extensions.

Using Padding to Align Data

However, when accessing SIMD data using SIMD operations, access to data can be improved simply by a change in the declaration. For example, consider a declaration of a structure, which represents a point in space plus an attribute.

```
typedef struct { short x,y,z; char a } Point;
Point pt [N];
```

Assume we will be performing a number of computations on *x*, *y*, *z* in three of the four elements of a SIMD word; see the “Data Structure Layout” section for an example. Even if the first element in array *pt* is aligned, the second element will start 7 bytes later and not be aligned (3 shorts at two bytes each plus a single byte = 7 bytes).

By adding the padding variable *pad*, the structure is now 8 bytes, and if the first element is aligned to 8 bytes (64 bits), all following elements will also be aligned. The sample declaration follows:

```
typedef struct { short x,y,z; char a; char pad; }
Point;
Point pt [N];
```

Using Arrays to Make Data Contiguous

In the following code,

```
for (i=0; i<N; i++) pt[i].y *= scale;
```

the second dimension y needs to be multiplied by a scaling value. Here the `for` loop accesses each y dimension in the array `pt` thus disallowing the access to contiguous data. This can degrade the performance of the application by increasing cache misses, by achieving poor utilization of each cache line that is fetched, and by increasing the chance for accesses which span multiple cache lines.

The following declaration allows you to vectorize the scaling operation and further improve the alignment of the data access patterns:

```
short ptx[N], pty[N], ptz[N];
for (i=0; i<N; i++) pty[i] *= scale;
```

With the SIMD technology, choice of data organization becomes more important and should be made carefully based on the operations that will be performed on the data. In some applications, traditional data arrangements may not lead to the maximum performance.

A simple example of this is an FIR filter. An FIR filter is effectively a vector dot product in the length of the number of coefficient taps.

Consider the following code:

```
(data [ j ] *coeff [0] + data [j+1]*coeff [1]+...+data
[j+num of taps-1]*coeff [num of taps-1]),
```

If in the code above the filter operation of data element i is the vector dot product that begins at data element j , then the filter operation of data element $i+1$ begins at data element $j+1$.

Assuming you have a 64-bit aligned data vector and a 64-bit aligned coefficients vector, the filter operation on the first data element will be fully aligned. For the second data element, however, access to the data vector will be misaligned. For an example of how to avoid the misalignment problem in the FIR filter, please refer to the application notes available at <http://developer.intel.com/software/idap/processor/ia32/pentiumiii/sse.htm>.

Duplication and padding of data structures can be used to avoid the problem of data accesses in algorithms which are inherently misaligned. The “Data Structure Layout” section discusses further trade-offs for how data structures are organized.



CAUTION. *The duplication and padding technique overcomes the misalignment problem, thus avoiding the expensive penalty for misaligned data access, at the cost of increasing the data size. When developing your code, you should consider this tradeoff and use the option which gives the best performance.*

Stack Alignment For 128-bit SIMD Technologies

For best performance, the Streaming SIMD Extensions and Streaming SIMD Extensions 2 require their memory operands to be aligned to 16-byte (16B) boundaries. Unaligned data can cause significant performance penalties compared to aligned data. However, the existing software conventions for IA-32 (`stdcall`, `cdecl`, `fastcall`) as implemented in most compilers, do not provide any mechanism for ensuring that certain local data and certain parameters are 16-byte aligned. Therefore, Intel has defined a new set of IA-32 software conventions for alignment to support the new `__m128*` datatypes (`__m128`, `__m128d`, and `__m128i`) that meet the following conditions:

- Functions that use Streaming SIMD Extensions or Streaming SIMD Extensions 2 data need to provide a 16-byte aligned stack frame.
- The `__m128*` parameters need to be aligned to 16-byte boundaries, possibly creating “holes” (due to padding) in the argument block.

These new conventions presented in this section as implemented by the Intel C++ Compiler can be used as a guideline for an assembly language code as well. In many cases, this section assumes the use of the `__m128*` data types, as defined by the Intel C++ Compiler, which represents an array of four 32-bit floats.

For more details on the stack alignment for Streaming SIMD Extensions and SSE2, see Appendix D, “Stack Alignment”.

Data Alignment for MMX Technology

Many compilers enable alignment of variables using controls. This aligns the variables’ bit lengths to the appropriate boundaries. If some of the variables are not appropriately aligned as specified, you can align them using the C algorithm shown in Example 3-11.

Example 3-11 C Algorithm for 64-bit Data Alignment

```
/* Make newp a pointer to a 64-bit aligned array */
/* of NUM_ELEMENTS 64-bit elements. */
double *p, *newp;
p = (double*)malloc (sizeof(double)*(NUM_ELEMENTS+1));
newp = (p+7) & (~0x7);
```

The algorithm in Example 3-11 aligns an array of 64-bit elements on a 64-bit boundary. The constant of 7 is derived from one less than the number of bytes in a 64-bit element, or 8-1. Aligning data in this manner avoids the significant performance penalties that can occur when an access crosses a cache line boundary.

Another way to improve data alignment is to copy the data into locations that are aligned on 64-bit boundaries. When the data is accessed frequently, this can provide a significant performance improvement.

Data Alignment for 128-bit data

Data must be 16-byte aligned when loading to or storing from the 128-bit XMM registers used by SSE and SSE2 to avoid severe performance penalties at best, and at worst, execution faults. Although there are move instructions (and intrinsics) to allow unaligned data to be copied into and out of the XMM registers when not using aligned data, such operations are much slower than aligned accesses. If, however, the data is not 16-byte-aligned and the programmer or the compiler does not detect this and uses the aligned instructions, a fault will occur. So, the rule is: keep the data 16-byte-aligned. Such alignment will also work for MMX technology code, even though MMX technology only requires 8-byte alignment. The following discussion and examples describe alignment techniques for Pentium 4 processor as implemented with the Intel C++ Compiler.

Compiler-Supported Alignment

The Intel C++ Compiler provides the following methods to ensure that the data is aligned.

Alignment by `F32vec4` or `__m128` Data Types. When compiler detects `F32vec4` or `__m128` data declarations or parameters, it will force alignment of the object to a 16-byte boundary for both global and local data, as well as parameters. If the declaration is within a function, the compiler will also align the function's stack frame to ensure that local data and parameters are 16-byte-aligned. For details on the stack frame layout that the compiler generates for both debug and optimized ("release"-mode) compilations, please refer to the relevant Intel application notes in the Intel Architecture Performance Training Center provided with the SDK.

The `__declspec(align(16))` specifications can be placed before data declarations to force 16-byte alignment. This is particularly useful for local or global data declarations that are assigned to 128-bit data types. The syntax for it is

```
__declspec(align(integer-constant))
```

where the *integer-constant* is an integral power of two but no greater than 32. For example, the following increases the alignment to 16-bytes:

```
__declspec(align(16)) float buffer[400];
```

The variable `buffer` could then be used as if it contained 100 objects of type `__m128` or `F32vec4`. In the code below, the construction of the `F32vec4` object, `x`, will occur with aligned data.

```
void foo() {
    F32vec4 x = *(__m128 *) buffer;
    ...
}
```

Without the declaration of `__declspec(align(16))`, a fault may occur.

Alignment by Using a union Structure. Preferably, when feasible, a union can be used with 128-bit data types to allow the compiler to align the data structure by default. Doing so is preferred to forcing alignment with `__declspec(align(16))` because it exposes the true program intent to the compiler in that `__m128` data is being used. For example:

```
union {
    float f[400];
    __m128 m[100];
} buffer;
```

The 16-byte alignment is used by default due to the `__m128` type in the union; it is not necessary to use `__declspec(align(16))` to force it.

In C++ (but not in C) it is also possible to force the alignment of a class/struct/union type, as in the code that follows:

```
struct __declspec(align(16)) my_m128
{
    float f[4];
};
```

But, if the data in such a `class` is going to be used with the Streaming SIMD Extensions or Streaming SIMD Extensions 2, it is preferable to use a `union` to make this explicit. In C++, an anonymous `union` can be used to make this more convenient:

```
class my_m128 {
    union {
        __m128 m;
        float f[4];
    };
};
```

In this example, because the `union` is anonymous, the names, `m` and `f`, can be used as immediate member names of `my__m128`. Note that `__declspec(align)` has no effect when applied to a `class`, `struct`, or `union` member in either C or C++.

Alignment by Using `__m64` or `double` Data. In some cases, for better performance, the compiler will align routines with `__m64` or `double` data to 16-bytes by default. The command-line switch, `-Qsfalign16`, can be used to limit the compiler to only align in routines that contain 128-bit data. The default behavior is to use `-Qsfalign8`, which instructs to align routines with 8- or 16-byte data types to 16-bytes.

For more details, see relevant Intel application notes in the Intel Architecture Performance Training Center provided with the SDK and the *Intel C++ Compiler User's Guide*.

Improving Memory Utilization

Memory performance can be improved by rearranging data and algorithms for SE 2, SSE, and MMX technology intrinsics. The methods for improving memory performance involve working with the following:

- Data structure layout
- Strip-mining for vectorization and memory utilization
- Loop-blocking

Using the cacheability instructions, prefetch and streaming store, also greatly enhance memory utilization. For these instructions, see Chapter 6, “Optimizing Cache Usage”.

Data Structure Layout

For certain algorithms, like 3D transformations and lighting, there are two basic ways of arranging the vertex data. The traditional method is the array of structures (AoS) arrangement, with a structure for each vertex (see Example 3-12). However this method does not take full advantage of the SIMD technology capabilities.

Example 3-12 AoS Data Structure

```
typedef struct {  
    float x,y,z;  
    int a,b,c;  
    . . .  
} Vertex;  
Vertex Vertices [NumOfVertices];
```

The best processing method for code using SIMD technology is to arrange the data in an array for each coordinate (see Example 3-13). This data arrangement is called structure of arrays (SoA).

Example 3-13 SoA Data Structure

```
typedef struct{
    float x[NumOfVertices];
    float y[NumOfVertices];
    float z[NumOfVertices];
    int a[NumOfVertices];
    int b[NumOfVertices];
    int c[NumOfVertices];
    . . .
} VerticesList;
VerticesList Vertices;
```

There are two options for computing data in AoS format: perform operation on the data as it stands in AoS format, or re-arrange it (swizzle it) into SoA format dynamically. See Example 3-14 for code samples of each option based on a dot-product computation.

Example 3-14 AoS and SoA Code Samples

```

; The dot product of an array of vectors (Array) and a
; fixed vector (Fixed) is a common operation in 3D
; lighting operations,
;   where Array = (x0,y0,z0), (x1,y1,z1), ...
;   and Fixed = (xF,yF,zF)
; A dot product is defined as the scalar quantity
;           d0 = x0*xF + y0*yF + z0*zF.

; AoS code
; All values marked DC are "don't-care."
; In the AOS model, the vertices are stored in the
; xyz format
movaps  xmm0, Array      ; xmm0 = DC, x0,   y0,   z0
movaps  xmm1, Fixed     ; xmm1 = DC, xF,   yF,   zF
mulps   xmm0, xmm1     ; xmm0 = DC, x0*xF, y0*yF, z0*zF
movhlps xmm1, xmm0     ; xmm1 = DC, DC,   DC,   x0*xF
addps   xmm1, xmm0     ; xmm0 = DC, DC,   DC,
;                               x0*xF+z0*zF

movaps  xmm2, xmm1
shufps  xmm2, xmm2, 55h ; xmm2 = DC, DC,   DC,   y0*yF
addps   mm2, xmm1     ; xmm1 = DC, DC,   DC,
;                               x0*xF+y0*yF+z0*zF

; SoA code
;
; X = x0,x1,x2,x3
; Y = y0,y1,y2,y3
; Z = z0,z1,z2,z3

```

continued

Example 3-14 AoS and SoA Code Samples (continued)

```

; A = xF, xF, xF, xF
; B = yF, yF, yF, yF
; C = zF, zF, zF, zF
movaps xmm0, X      ; xmm0 = x0, x1, x2, x3
movaps xmm1, Y      ; xmm1 = y0, y1, y2, y3
movaps xmm2, Z      ; xmm2 = z0, z1, z2, z3
mulps  xmm0, A      ; xmm0 = x0*xF, x1*xF, x2*xF, x3*xF
mulps  xmm1, B      ; xmm1 = y0*yF, y1*yF, y2*yF, y3*yF
mulps  xmm2, C      ; xmm2 = z0*zF, z1*zF, z2*zF, z3*zF
addps  xmm0, xmm1
addps  xmm0, xmm2   ; xmm0 = (x0*xF+y0*yF+z0*zF), ...

```

Performing SIMD operations on the original AoS format can require more calculations and some of the operations do not take advantage of all of the SIMD elements available. Therefore, this option is generally less efficient.

The recommended way for computing data in AoS format is to swizzle each set of elements to SoA format before processing it using SIMD technologies. This swizzling can either be done dynamically during program execution or statically when the data structures are generated; see Chapters 4 and 5 for specific examples of swizzling code.

Performing the swizzle dynamically is usually better than using AoS, but is somewhat inefficient as there is the overhead of extra instructions during computation. Performing the swizzle statically, when the data structures are being laid out, is best as there is no runtime overhead.

As mentioned earlier, the SoA arrangement allows more efficient use of the parallelism of the SIMD technologies because the data is ready for computation in a more optimal vertical manner: multiplying components x_0, x_1, x_2, x_3 by x_F, x_F, x_F, x_F using 4 SIMD execution slots to produce 4 unique results. In contrast, computing directly on AoS

data can lead to horizontal operations that consume SIMD execution slots but produce only a single scalar result as shown by the many “don’t-care” (DC) slots in Example 3-14.

Use of the SoA format for data structures can also lead to more efficient use of caches and bandwidth. When the elements of the structure are not accessed with equal frequency, such as when element x , y , z are accessed ten times more often than the other entries, then SoA not only saves memory, but it also prevents fetching unnecessary data items a , b , and c .

Example 3-15 Hybrid SoA data structure

```

NumOfGroups = NumOfVertices/SIMDwidth
typedef struct{
    float x[SIMDwidth];
    float y[SIMDwidth];
    float z[SIMDwidth];
} VerticesCoordList;
typedef struct{
    int a[SIMDwidth];
    int b[SIMDwidth];
    int c[SIMDwidth];
    . . .
} VerticesColorList;
VerticesCoordList VerticesCoord [NumOfGroups];
VerticesColorList VerticesColor [NumOfGroups];

```

Note that SoA can have the disadvantage of requiring more independent memory stream references. A computation that uses arrays x , y , and z in Example 3-13 would require three separate data streams. This can require the use of more prefetches, additional address generation calculations, as well as having a greater impact on DRAM page access efficiency. An alternative, a hybrid SoA approach blends the two alternatives (see Example 3-15). In this case, only 2 separate address streams are generated and referenced: one which contains $xxxx, yyyy, zzzz, zzzz, \dots$ and the other which contains

aaaa,bbbb,cccc,aaaa,dddd, . . . This also prevents fetching unnecessary data, assuming the variables x , y , z are always used together; whereas the variables a , b , c would also be used together, but not at the same time as x , y , z . This hybrid SoA approach ensures:

- data is organized to enable more efficient vertical SIMD computation,
- simpler/less address generation than AoS,
- fewer streams, which reduces DRAM page misses,
- use of fewer prefetches, due to fewer streams,
- efficient cache line packing of data elements that are used concurrently.

With the advent of the SIMD technologies, the choice of data organization becomes more important and should be carefully based on the operations to be performed on the data. This will become increasingly important in the Pentium 4 processor and future processors. In some applications, traditional data arrangements may not lead to the maximum performance. Application developers are encouraged to explore different data arrangements and data segmentation policies for efficient computation. This may mean using a combination of AoS, SoA, and Hybrid SoA in a given application.

Strip Mining

Strip mining, also known as loop sectioning, is a loop transformation technique for enabling SIMD-encodings of loops, as well as providing a means of improving memory performance. First introduced for vectorizers, this technique consists of the generation of code when each vector operation is done for a size less than or equal to the maximum vector length on a given vector machine. By fragmenting a large loop into smaller segments or strips, this technique transforms the loop structure twofold:

- It increases the temporal and spatial locality in the data cache if the data are reusable in different passes of an algorithm.

- It reduces the number of iterations of the loop by a factor of the length of each “vector,” or number of operations being performed per SIMD operation. In the case of Streaming SIMD Extensions, this vector or strip-length is reduced by 4 times: four floating-point data items per single Streaming SIMD Extensions single-precision floating-point SIMD operation are processed. Consider Example 3-16.

Example 3-16 Pseudo-code Before Strip Mining

```
typedef struct _VERTEX {
    float x, y, z, nx, ny, nz, u, v;
} Vertex_rec;

main()
{
    Vertex_rec v[Num];
    ....
    for (i=0; i<Num; i++) {
        Transform(v[i]);
    }
    for (i=0; i<Num; i++) {
        Lighting(v[i]);
    }
    ....
}
```

The main loop consists of two functions: transformation and lighting. For each object, the main loop calls a transformation routine to update some data, then calls the lighting routine to further work on the data. If the size of array `v[Num]` is larger than the cache, then the coordinates for `v[i]` that were cached during `Transform(v[i])` will be evicted from

the cache by the time we do `Lighting(v[i])`. This means that `v[i]` will have to be fetched from main memory a second time, reducing performance.

Example 3-17 Strip Mined Code

```
main()
{
    Vertex_rec v[Num];
    ....
    for (i=0; i < Num; i+=strip_size) {
        for (j=i; j < min(Num, i+strip_size); j++) {
            Transform(v[j]);
        }
        for (j=i; j < min(Num, i+strip_size); j++) {
            Lighting(v[j]);
        }
    }
}
```

In Example 3-17, the computation has been strip-mined to a size `strip_size`. The value `strip_size` is chosen such that `strip_size` elements of array `v[Num]` fit into the cache hierarchy. By doing this, a given element `v[i]` brought into the cache by `Transform(v[i])` will still be in the cache when we perform `Lighting(v[i])`, and thus improve performance over the non-strip-mined code.

Loop Blocking

Loop blocking is another useful technique for memory performance optimization. The main purpose of loop blocking is also to eliminate as many cache misses as possible. This technique transforms the memory domain of a given problem into smaller chunks rather than sequentially traversing through the entire memory domain. Each chunk should be

small enough to fit all the data for a given computation into the cache, thereby maximizing data reuse. In fact, one can treat loop blocking as strip mining in two or more dimensions. Consider the code in Example 3-16 and access pattern in Figure 3-3. The two-dimensional array *A* is referenced in the *j* (column) direction and then referenced in the *i* (row) direction (column-major order); whereas array *B* is referenced in the opposite manner (row-major order). Assume the memory layout is in column-major order; therefore, the access strides of array *A* and *B* for the code in Example 3-18 would be 1 and *MAX*, respectively.

Example 3-18 Loop Blocking

A. Original Loop

```
float A[MAX, MAX], B[MAX, MAX]
for (i=0; i< MAX; i++) {
    for (j=0; j< MAX; j++) {
        A[i,j] = A[i,j] + B[j, i];
    }
}
```

B. Transformed Loop after Blocking

```
float A[MAX, MAX], B[MAX, MAX];
for (i=0; i< MAX; i+=block_size) {
    for (j=0; j< MAX; j+=block_size) {
        for (ii=i; ii<i+block_size; ii++) {
            for (jj=j; jj<j+block_size; jj++) {
                A[ii,jj] = A[ii,jj] + B[jj, ii];
            }
        }
    }
}
```

For the first iteration of the inner loop, each access to array `B` will generate a cache miss. If the size of one row of array `A`, that is, `A[2, 0:MAX-1]`, is large enough, by the time the second iteration starts, each access to array `B` will always generate a cache miss. For instance, on the first iteration, the cache line containing `B[0, 0:7]` will be brought in when `B[0, 0]` is referenced because the `float` type variable is four bytes and each cache line is 32 bytes. Due to the limitation of cache capacity, this line will be evicted due to conflict misses before the inner loop reaches the end. For the next iteration of the outer loop, another cache miss will be generated while referencing `B[0, 1]`. In this manner, a cache miss occurs when each element of array `B` is referenced, that is, there is no data reuse in the cache at all for array `B`.

This situation can be avoided if the loop is blocked with respect to the cache size. In Figure 3-3, `block_size` is selected as the loop blocking factor. Suppose that `block_size` is 8, then the blocked chunk of each array will be eight cache lines (32 bytes each). In the first iteration of the inner loop, `A[0, 0:7]` and `B[0, 0:7]` will be brought into the cache. `B[0, 0:7]` will be completely consumed by the first iteration of the outer loop. Consequently, `B[0, 0:7]` will only experience one cache miss after applying loop blocking optimization in lieu of eight misses for the original algorithm. As illustrated in Figure 3-3, arrays `A` and `B` are blocked into smaller rectangular chunks so that the total size of two blocked `A` and `B` chunks is smaller than the cache size. This allows maximum data reuse.

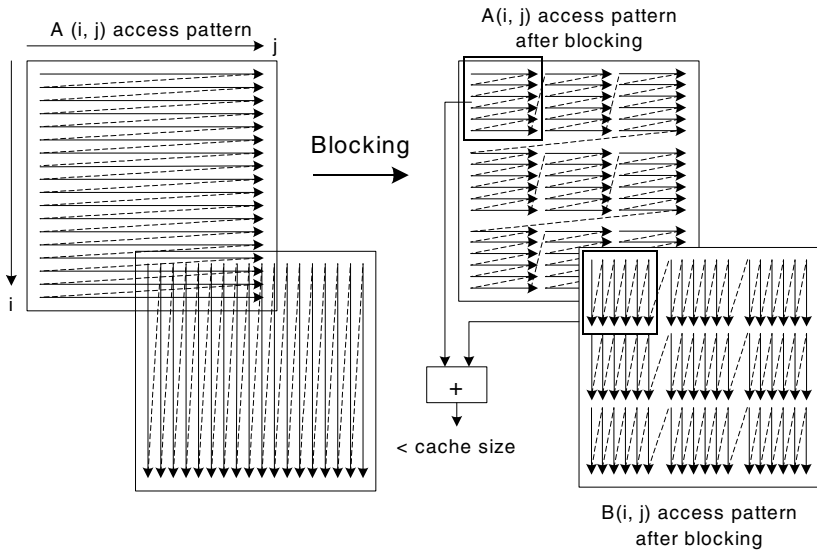
Figure 3-3 Loop Blocking Access Pattern

OM15158

As one can see, all the redundant cache misses can be eliminated by applying this loop blocking technique. If MAX is huge, loop blocking can also help reduce the penalty from DTLB (data translation look-aside buffer) misses. In addition to improving the cache/memory performance, this optimization technique also saves external bus bandwidth.

Instruction Selection

The following section gives some guidelines for choosing instructions to complete a task.

One barrier to SIMD computation can be the existence of data-dependent branches. Conditional moves can be used to eliminate data-dependent branches. Conditional moves can be emulated in SIMD computation by using masked compares and logicals, as shown in Example 3-19.

Example 3-19 Emulation of Conditional Moves

High-level code:

```
short A[MAX_ELEMENT], B[MAX_ELEMENT], C[MAX_ELEMENT],
D[MAX_ELEMENT], E[MAX_ELEMENT];
```

```
for (i=0; i<MAX_ELEMENT; i++) {
    if (A[i] > B[i]) {
        C[i] = D[i];
    } else {
        C[i] = E[i];
    }
}
```

Assembly code:

```
    xor     eax, eax
top_of_loop:
    movq   mm0, [A + eax]
    pcmpgtw mm0, [B + eax]; Create compare mask
    movq   mm1, [D + eax]
    pand   mm1, mm0; Drop elements where A<B
    pandn  mm0, [E + eax] ; Drop elements where A>B
    por    mm0, mm1; Create single word
    movq   [C + eax], mm0
    add    eax, 8
    cmp    eax, MAX_ELEMENT*2
    jle    top_of_loop
```

Note that this can be applied to both SIMD integer and SIMD floating-point code.

If there are multiple consumers of an instance of a register, group the consumers together as closely as possible. However, the consumers should not be scheduled near the producer.

Tuning the Final Application

The best way to tune your application once it is functioning correctly is to use a profiler that measures the application while it is running on a system. VTune analyzer can help you determine where to make changes in your application to improve performance. Using the VTune analyzer can help you with various phases required for optimized performance. See “Intel® VTune™ Performance Analyzer” in Appendix A for more details on how to use the VTune analyzer. After every effort to optimize, you should check the performance gains to see where you are making your major optimization gains.

Optimizing for SIMD Integer Applications

4

The SIMD integer instructions provide performance improvements in applications that are integer-intensive and can take advantage of the SIMD architecture of Pentium 4, Intel Xeon, and Pentium M processors.

The guidelines for using these instructions in addition to the guidelines described in Chapter 2, will help develop fast and efficient code that scales well across all processors with MMX technology, processors that use Streaming SIMD Extensions (SSE) SIMD integer instructions, as well as the Pentium 4 processor with the SIMD integer instructions in the Streaming SIMD Extensions 2 (SSE2).

For the sake of brevity, the collection of 64-bit and 128-bit SIMD integer instructions supported by MMX technology, SSE, and SSE2 shall be referred to as SIMD integer instructions.

Unless otherwise noted, the following sequences are written for the 64-bit integer registers. Note that they can easily be changed to use the 128-bit SIMD integer form available with SSE2 by replacing the references to `mm0-mm7` with references to `xmm0-xmm7`.

This chapter contains several simple examples that will help you to get started with coding your application. The goal is to provide simple, low-level operations that are frequently used. The examples use a minimum number of instructions necessary to achieve best performance on the current generation of IA-32 processors.

Each example includes a short description, sample code, and notes if necessary. These examples do not address scheduling as it is assumed the examples will be incorporated in longer code sequences.

For planning considerations of using the new SIMD integer instructions, refer to “Checking for Streaming SIMD Extensions 2 Support” in Chapter 3.

General Rules on SIMD Integer Code

The overall rules and suggestions are as follows:

- Do not intermix 64-bit SIMD integer instructions with x87 floating-point instructions. See “Using SIMD Integer with x87 Floating-point” section. Note that all of the SIMD integer instructions can be intermixed without penalty.
- When writing SSE2 code that works with both integer and floating-point data, use the subset of SIMD convert instructions or load/store instructions to ensure that the input operands in XMM registers contain properly defined data type to match the instruction. Code sequences containing cross-typed usage will produce the same result across different implementations, but will incur a significant performance penalty. Using SSE or SSE2 instructions to operate on type-mismatched SIMD data in the XMM register is strongly discouraged.
- Use the optimization rules and guidelines described in Chapters 2 and 3 that apply to the Pentium 4, Intel Xeon and Pentium M processors.
- Take advantage of hardware prefetcher where possible. Use prefetch instruction only when data access patterns are irregular and prefetch distance can be pre-determined. (for details, refer to Chapter 6, “Optimizing Cache Usage”).
- Emulate conditional moves by using masked compares and logicals instead of using conditional branches.

Using SIMD Integer with x87 Floating-point

All 64-bit SIMD integer instructions use the MMX registers, which share register state with the x87 floating-point stack. Because of this sharing, certain rules and considerations apply. Instructions which use the MMX registers cannot be freely intermixed with x87 floating-point registers. Care must be taken when switching between using 64-bit SIMD integer instructions and x87 floating-point instructions (see “Using the EMMS Instruction” section below).

The SIMD floating-point operations and 128-bit SIMD integer operations can be freely intermixed with either x87 floating-point operations or 64-bit SIMD integer operations. The SIMD floating-point operations and 128-bit SIMD integer operations use registers that are unrelated to the x87 FP / MMX registers. The `emms` instruction is not needed to transition to or from SIMD floating-point operations or 128-bit SIMD operations.

Using the EMMS Instruction

When generating 64-bit SIMD integer code, keep in mind that the eight MMX registers are aliased on the x87 floating-point registers. Switching from MMX instructions to x87 floating-point instructions incurs a finite delay, so it is the best to minimize switching between these instruction types. But when you need to switch, the `emms` instruction provides an efficient means to clear the x87 stack so that subsequent x87 code can operate properly on the x87 stack.

As soon as any instruction makes reference to an MMX register, all valid bits in the x87 floating-point tag word are set, which implies that all x87 registers contain valid values. In order for software to operate correctly, the x87 floating-point stack should be emptied when starting a series of x87 floating-point calculations after operating on the MMX registers

Using `emms` clears all of the valid bits, effectively emptying the x87 floating-point stack and making it ready for new x87 floating-point operations. The `emms` instruction ensures a clean transition between using operations on the MMX registers and using operations on the x87 floating-point stack. On the Pentium 4 processor, there is a finite overhead for using the `emms` instruction.

Failure to use the `emms` instruction (or the `_mm_empty()` intrinsic) between operations on the MMX registers and operations on the x87 floating-point registers may lead to unexpected results.



CAUTION. *Failure to reset the tag word for FP instructions after using an MMX instruction can result in faulty execution or poor performance.*

Guidelines for Using EMMS Instruction

When developing code with both x87 floating-point and 64-bit SIMD integer instructions, follow these steps:

1. Always call the `emms` instruction at the end of 64-bit SIMD integer code when the code transitions to x87 floating-point code.
2. Insert the `emms` instruction at the end of all 64-bit SIMD integer code segments to avoid an x87 floating-point stack overflow exception when an x87 floating-point instruction is executed.

When writing an application that uses both floating-point and 64-bit SIMD integer instructions, use the following guidelines to help you determine when to use `emms`:

- *If next instruction is x87 FP:* Use `_mm_empty()` after a 64-bit SIMD integer instruction if the next instruction is an x87 FP instruction; for example, before doing calculations on floats, doubles or long doubles.

- *Don't empty when already empty:* If the next instruction uses an MMX register, `_mm_empty()` incurs a cost with no benefit.
- *Group Instructions:* Try to partition regions that use x87 FP instructions from those that use 64-bit SIMD integer instructions. This eliminates needing an `emms` instruction within the body of a critical loop.
- *Runtime initialization:* Use `_mm_empty()` during runtime initialization of `__m64` and x87 FP data types. This ensures resetting the register between data type transitions. See Example 4-1 for coding usage.

Example 4-1 Resetting the Register between `__m64` and FP Data Types

Incorrect Usage	Correct Usage
<pre>__m64 x = _m_padd(y, z); float f = init();</pre>	<pre>__m64 x = _m_padd(y, z); float f = (_mm_empty(), init());</pre>

Further, you must be aware that your code generates an MMX instruction, which uses the MMX registers with the Intel C++ Compiler, in the following situations:

- when using a 64-bit SIMD integer intrinsic from MMX technology, SSE, or SSE2
- when using a 64-bit SIMD integer instruction from MMX technology, SSE, or SSE2 through inline assembly
- when referencing an `__m64` data type variable

Additional information on the x87 floating-point programming model can be found in the *IA-32 Intel® Architecture Software Developer's Manual*, Volume 1. For more documentation on `emms`, visit the <http://developer.intel.com> web site.

Data Alignment

Make sure that 64-bit SIMD integer data is 8-byte aligned and that 128-bit SIMD integer data is 16-byte aligned. Referencing unaligned 64-bit SIMD integer data can incur a performance penalty due to accesses that span 2 cache lines. Referencing unaligned 128-bit SIMD integer data will result in an exception unless the `movdqu` (move double-quadword unaligned) instruction is used. Using the `movdqu` instruction on unaligned data can result in lower performance than using 16-byte aligned references.

Refer to section “Stack and Data Alignment” in Chapter 3 for more information.

Data Movement Coding Techniques

In general, better performance can be achieved if the data is pre-arranged for SIMD computation (see the “Improving Memory Utilization” section of Chapter 3). However, this may not always be possible. This section covers techniques for gathering and re-arranging data for more efficient SIMD computation.

Unsigned Unpack

The MMX technology provides several instructions that are used to pack and unpack data in the MMX registers. The unpack instructions can be used to zero-extend an unsigned number. Example 4-2 assumes the source is a packed-word (16-bit) data type.

Example 4-2 Unsigned Unpack Instructions

```
; Input:
;           MM0           source value
;           MM7 0       a local variable can be used
;                       instead of the register MM7 if
;                       desired.
; Output:
;           MM0           two zero-extended 32-bit
;                       doublewords from two low-end
;                       words
;           MM1           two zero-extended 32-bit
;                       doublewords from two high-end
;                       words

movq       MM1, MM0      ; copy source
punpcklwd  MM0, MM7      ; unpack the 2 low-end words
;                       into two 32-bit doubleword
punpckhwd  MM1, MM7      ; unpack the 2 high-end words
;                       into two 32-bit doublewords
```

Signed Unpack

Signed numbers should be sign-extended when unpacking the values. This is similar to the zero-extend shown above except that the `psrad` instruction (packed shift right arithmetic) is used to effectively sign extend the values. Example 4-3 assumes the source is a packed-word (16-bit) data type.

Example 4-3 Signed Unpack Code

```
; Input :
;          MM0          source value
; Output :
;          MM0          two sign-extended 32-bit doublewords
;                   from the two low-end words
;          MM1          two sign-extended 32-bit doublewords
;                   from the two high-end words
;
movq      MM1, MM0    ; copy source
punpcklwd MM0, MM0    ; unpack the 2 low end words of the source
;                   ; into the second and fourth words of the
;                   ; destination
punpckhwd MM1, MM1    ; unpack the 2 high-end words of the source
;                   ; into the second and fourth words of the
;                   ; destination
psrad     MM0, 16     ; sign-extend the 2 low-end words of the
source                                     ; into two 32-bit signed doublewords
psrad     MM1, 16     ; sign-extend the 2 high-end words of the
; source into two 32-bit signed doublewords
```

Interleaved Pack with Saturation

The pack instructions pack two values into the destination register in a predetermined order. Specifically, the `packssdw` instruction packs two signed doublewords from the source operand and two signed doublewords from the destination operand into four signed words in the destination register as shown in Figure 4-1.

Figure 4-1 PACKSSDW mm, mm/mm64 Instruction Example

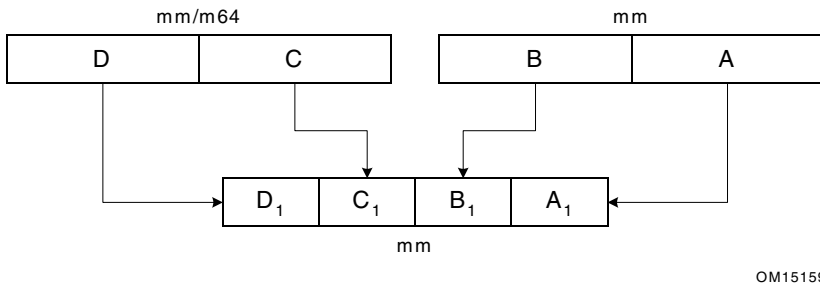
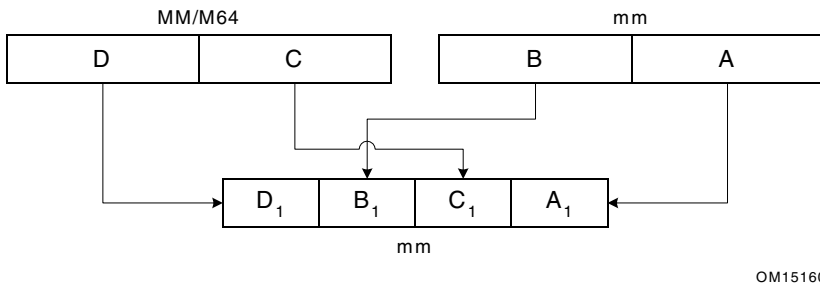

Figure 4-2 illustrates two values interleaved in the destination register, and Example 4-4 shows code that uses the operation. The two signed doublewords are used as source operands and the result is interleaved signed words. The pack instructions can be performed with or without saturation as needed.

Figure 4-2 Interleaved Pack with Saturation



Example 4-4 Interleaved Pack with Saturation

```
    ; Input :
    ;           MM0           signed source1 value
    ;           MM1           signed source2 value
    ; Output :
    ;           MM0           the first and third words contain
the                               signed-saturated doublewords from
    ;                               MM0 ,
    ;                               the second and fourth words contain
    ;                               signed-saturated doublewords from
MM1
    ;
packssdw   MM0, MM0   ; pack and sign saturate
packssdw   MM1, MM1   ; pack and sign saturate
punpcklwd  MM0, MM1   ; interleave the low-end 16-bit
                               ; values of the operands
```

The pack instructions always assume that the source operands are signed numbers. The result in the destination register is always defined by the pack instruction that performs the operation. For example, the `packssdw` instruction packs each of the two signed 32-bit values of the two sources into four saturated 16-bit signed values in the destination register. The `packuswb` instruction, on the other hand, packs each of the four signed 16-bit values of the two sources into eight saturated eight-bit unsigned values in the destination. A complete specification of the MMX instruction set can be found in the *Intel Architecture MMX Technology Programmer's Reference Manual*, order number 243007.

Interleaved Pack without Saturation

Example 4-5 is similar to Example 4-4 except that the resulting words are not saturated. In addition, in order to protect against overflow, only the low order 16 bits of each doubleword are used in this operation.

Example 4-5 Interleaved Pack without Saturation

```
; Input:
;   MM0      signed source value
;   MM1      signed source value
; Output:
;   MM0      the first and third words contain the
;             low 16-bits of the doublewords in MM0,
;             the second and fourth words contain the
;             low 16-bits of the doublewords in MM1

pslld  MM1, 16      ; shift the 16 LSB from each of the
                   ; doubleword values to the 16 MSB
                   ; position

pand   MM0, {0,ffff,0,ffff}
                   ; mask to zero the 16 MSB
                   ; of each doubleword value

por    MM0, MM1     ; merge the two operands
```

Non-Interleaved Unpack

The unpack instructions perform an interleave merge of the data elements of the destination and source operands into the destination register. The following example merges the two operands into the destination registers without interleaving. For example, take two adjacent elements of a packed-word data type in `source1` and place this value in the low 32 bits of the results. Then take two adjacent elements of a packed-word data type in `source2` and place this value in the high 32 bits of the results. One of the destination registers will have the combination illustrated in Figure 4-3.

Figure 4-3 Result of Non-Interleaved Unpack Low in MM0

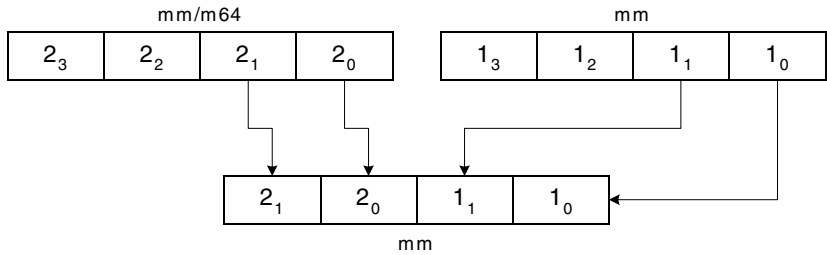

OM15161

The other destination register will contain the opposite combination illustrated in Figure 4-4.

Figure 4-4 Result of Non-Interleaved Unpack High in MM1

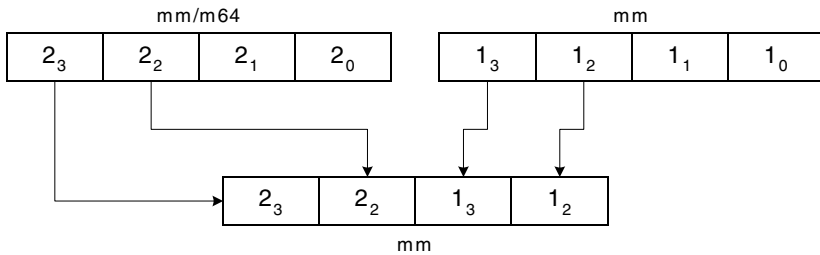

OM15162

Code in the Example 4-6 unpacks two packed-word sources in a non-interleaved way. The goal is to use the instruction which unpacks doublewords to a quadword, instead of using the instruction which unpacks words to doublewords.

Example 4-6 Unpacking Two Packed-word Sources in a Non-interleaved Way

```
; Input :
;          MM0          packed-word source value
;          MM1          packed-word source value
; Output :
;          MM0          contains the two low-end words of the
;                      original sources, non-interleaved
;          MM2          contains the two high end words of the
;                      original sources, non-interleaved.
movq      MM2, MM0      ; copy source1
punpckldq MM0, MM1      ; replace the two high-end words
;                      ; of MM0 with two low-end words of
;                      ; MM1; leave the two low-end words
;                      ; of MM0 in place
punpckhdq MM2, MM1      ; move two high-end words of MM2
;                      ; to the two low-end words of MM2;
;                      ; place the two high-end words of
;                      ; MM1 in two high-end words of MM2
```

Extract Word

The `pextrw` instruction takes the word in the designated MMX register selected by the two least significant bits of the immediate value and moves it to the lower half of a 32-bit integer register, see Figure 4-5 and Example 4-7.

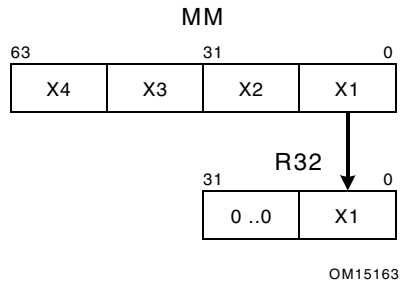
Figure 4-5 `pextrw` Instruction**Example 4-7** `pextrw` Instruction Code

```

; Input:
;     eax     source value
;           immediate value:"0"
; Output:
;     edx     32-bit integer register containing the
;           extracted word in the low-order bits &
;           the high-order bits zero-extended
movq    mm0, [eax]
pextrw  edx, mm0, 0

```

Insert Word

The `pinsrw` instruction loads a word from the lower half of a 32-bit integer register or from memory and inserts it in the MMX technology destination register at a position defined by the two least significant bits of the immediate constant. Insertion is done in such a way that the three other words from the destination register are left untouched, see Figure 4-6 and Example 4-8.

Figure 4-6 `pinsrw` Instruction

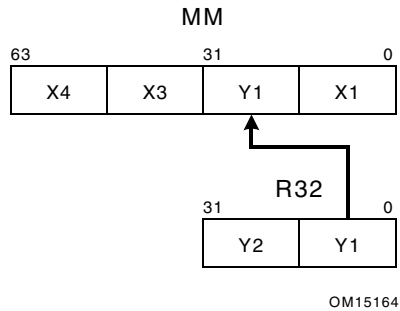

Example 4-8 `pinsrw` Instruction Code

```

; Input:
;     edx     pointer to source value
; Output:
;     mm0     register with new 16-bit value inserted
;
mov     eax, [edx]
pinsrw mm0, eax, 1
    
```

If all of the operands in a register are being replaced by a series of `pinsrw` instructions, it can be useful to clear the content and break the dependence chain by either using the `pxor` instruction or loading the register. See the “Clearing Registers” section in Chapter 2.

Example 4-9 Repeated pinsrw Instruction Code

```
; Input:
;         edx         pointer to structure containing source
;         values at offsets: of +0, +10, +13, and +24
;         immediate value: "1"
; Output:
;         MMX         register with new 16-bit value inserted
;
pxor     mm0, mm0    ; Breaks dependedncy on previous value of
mm0
mov      eax, [edx]
pinsrw  mm0, eax, 0
mov      eax, [edx+10]
pinsrw  mm0, eax, 1
mov      eax, [edx+13]
pinsrw  mm0, eax, 2
mov      eax, [edx+24]
pinsrw  mm0, eax, 3
```

Move Byte Mask to Integer

The `pmovmskb` instruction returns a bit mask formed from the most significant bits of each byte of its source operand. When used with the 64-bit MMX registers, this produces an 8-bit mask, zeroing out the upper 24 bits in the destination register. When used with the 128-bit XMM registers, it produces a 16-bit mask, zeroing out the upper 16 bits in the destination register. The 64-bit version is shown in Figure 4-7 and Example 4-10.

Figure 4-7 `pmovmskb` Instruction Example

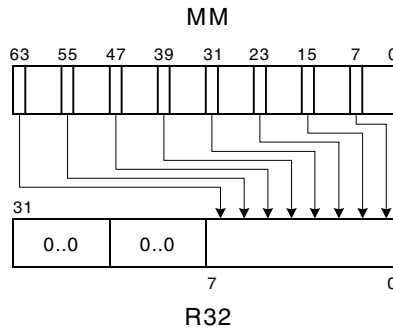

Example 4-10 `pmovmskb` Instruction Code

```

; Input:
;     source value
; Output:
;     32-bit register containing the byte mask in the
lower
;     eight bits
;
movq    mm0, [edi]
pmovmskb eax, mm0
    
```

Packed Shuffle Word for 64-bit Registers

The `pshuf` instruction (see Figure 4-8, Example 4-11) uses the immediate (`imm8`) operand to select between the four words in either two MMX registers or one MMX register and a 64-bit memory location. Bits 1 and 0 of the immediate value encode the source for destination word 0 in MMX register (`[15-0]`), and so on as shown in the table:

Bits	Word
1 - 0	0
3 - 2	1
5 - 4	2
7 - 6	3

Bits 7 and 6 encode for word 3 in MMX register (`[63-48]`). Similarly, the 2-bit encoding represents which source word is used, for example, binary encoding of 10 indicates that source word 2 in MMX register/memory (`mm/mem[47-32]`) is used, see Figure 4-8 and Example 4-11.

Figure 4-8 `pshuf` Instruction Example



OM15166

Example 4-11 pshuf Instruction Code

```

; Input:
;     edi          source value
; Output:
;     MM1          MM register containing re-arranged
words
movq   mm0, [edi]
pshufw mm1, mm0, 0x1b
    
```

Packed Shuffle Word for 128-bit Registers

The `pshufw/pshufhw` instruction performs a full shuffle of any source word field within the low/high 64 bits to any result word field in the low/high 64 bits, using an 8-bit immediate operand; the other high/low 64 bits are passed through from the source operand.

The `pshufd` instruction performs a full shuffle of any double-word field within the 128-bit source to any double-word field in the 128-bit result, using an 8-bit immediate operand.

No more than 3 instructions, using `pshufw/pshufhw/pshufd`, are required to implement some common data shuffling operations. Broadcast, Swap, and Reverse are illustrated in Example 4-12, Example 4-13, and Example 4-14, respectively.

Example 4-12 Broadcast Using 2 Instructions

```

/* Goal: Broadcast the value from word 5 to all words */
/* Instruction Result */
      | 7| 6| 5| 4| 3| 2| 1| 0|
PSHUFHW (3,2,1,1)| 7| 6| 5| 5| 3| 2| 1| 0|
PSHUFD (2,2,2,2)| 5| 5| 5| 5| 5| 5| 5| 5|
    
```

Example 4-13 Swap Using 3 Instructions

```
/* Goal: Swap the values in word 6 and word 1 */
/* Instruction Result */
    | 7| 6| 5| 4| 3| 2| 1| 0|

PSHUFD (3,0,1,2) | 7| 6| 1| 0| 3| 2| 5| 4|

PSHUFHW (3,1,2,0) | 7| 1| 6| 0| 3| 2| 5| 4|

PSHUFD (3,0,1,2) | 7| 1| 5| 4| 3| 2| 6| 0|
```

Example 4-14 Reverse Using 3 Instructions

```
/* Goal: Reverse the order of the words */
/* Instruction Result */
    | 7| 6| 5| 4| 3| 2| 1| 0|

PSHUFLW (0,1,2,3) | 7| 6| 5| 4| 0| 1| 2| 3|

PSHUFHW (0,1,2,3) | 4| 5| 6| 7| 0| 1| 2| 3|

PSHUFD (1,0,3,2) | 0| 1| 2| 3| 4| 5| 6| 7|
```

Unpacking/interleaving 64-bit Data in 128-bit Registers

The `punpcklqdq/punpchqdq` instructions interleave the low/high-order 64-bits of the source operand and the low/high-order 64-bits of the destination operand and writes them to the destination register. The high/low-order 64-bits of the source operands are ignored.

Data Movement

There are two additional instructions to enable data movement from the 64-bit SIMD integer registers to the 128-bit SIMD registers.

The `movq2dq` instruction moves the 64-bit integer data from an MMX register (source) to a 128-bit destination register. The high-order 64 bits of the destination register are zeroed-out.

The `movdq2q` instruction moves the low-order 64-bits of integer data from a 128-bit source register to an MMX register (destination).

Conversion Instructions

New instructions have been added to support 4-wide conversion of single-precision data to/from double-word integer data. Also, conversions between double-precision data and double-word integer data have been added.

Generating Constants

The SIMD integer instruction sets do not have instructions that will load immediate constants to the SIMD registers. The following code segments generate frequently used constants in the SIMD register. Of course, you can also put constants as local variables in memory, but when doing so be sure to duplicate the values in memory and load the values with a `movq`, `movdqa`, or `movdqu` instructions, see Example 4-15.

Example 4-15 Generating Constants

```
pxor    MM0, MM0    ; generate a zero register in MM0
pcmpeq  MM1, MM1    ; Generate all 1's in register MM1,
                    ; which is -1 in each of the packed
                    ; data type fields

pxor    MM0, MM0
pcmpeq  MM1, MM1
psubb   MM0, MM1 [psubw MM0, MM1] (psubd MM0, MM1)
                    ; three instructions above generate
                    ; the constant 1 in every
                    ; packed-byte [or packed-word]
                    ; (or packed-dword) field

pcmpeq  MM1, MM1
psrlw   MM1, 16-n (psrld MM1, 32-n)
                    ; two instructions above generate
                    ; the signed constant  $2^n-1$  in every
                    ; packed-word (or packed-dword) field

pcmpeq  MM1, MM1
psllw   MM1, n (pslld MM1, n)
                    ; two instructions above generate
                    ; the signed constant  $-2^n$  in every
                    ; packed-word (or packed-dword) field
```



NOTE. *Because the SIMD integer instruction sets do not support shift instructions for bytes, 2^n-1 and -2^n are relevant only for packed words and packed doublewords.*

Building Blocks

This section describes instructions and algorithms which implement common code building blocks efficiently.

Absolute Difference of Unsigned Numbers

Example 4-16 computes the absolute difference of two unsigned numbers. It assumes an unsigned packed-byte data type. Here, we make use of the subtract instruction with unsigned saturation. This instruction receives `UNSIGNED` operands and subtracts them with `UNSIGNED` saturation. This support exists only for packed bytes and packed words, not for packed doublewords.

Example 4-16 Absolute Difference of Two Unsigned Numbers

```
; Input:
;     MM0 source operand
;     MM1 source operand
; Output:
;     MM0 absolute difference of the unsigned
;           operands

movq   MM2, MM0    ; make a copy of MM0
psubusb MM0, MM1   ; compute difference one way
psubusb MM1, MM2   ; compute difference the other way
por    MM0, MM1    ; OR them together
```

This example will not work if the operands are signed.

Note that the `psadbw` instruction may also be used in some situations; see section “Packed Sum of Absolute Differences” for details.

Absolute Difference of Signed Numbers

Chapter 4 computes the absolute difference of two signed numbers.



NOTE. *There is no MMX™ technology subtract instruction that receives SIGNED operands and subtracts them with UNSIGNED saturation.*

The technique used here is to first sort the corresponding elements of the input operands into packed words of the maximum values, and packed words of the minimum values. Then the minimum values are subtracted from the maximum values to generate the required absolute difference. The key is a fast sorting technique that uses the fact that $B = \text{xor}(A, \text{xor}(A, B))$ and $A = \text{xor}(A, 0)$. Thus in a packed data type, having some elements being $\text{xor}(A, B)$ and some being 0, you could xor such an operand with A and receive in some places values of A and in some values of B . The following examples assume a packed-word data type, each element being a signed value.

Example 4-17 Absolute Difference of Signed Numbers

```

; Input:
;     MM0 signed source operand
;     MM1 signed source operand
; Output:
;     MM0 absolute difference of the unsigned
;         operands

movq    MM2, MM0    ; make a copy of source1 (A)
pcmpgtw MM0, MM1    ; create mask of
                    ; source1>source2 (A>B)

movq    MM4, MM2    ; make another copy of A
pxor    MM2, MM1    ; create the intermediate value of
                    ; the swap operation - xor(A,B)

pand    MM2, MM0    ; create a mask of 0s and xor(A,B)
                    ; elements. Where A>B there will
                    ; be a value xor(A,B) and where
                    ; A<=B there will be 0.

pxor    MM4, MM2    ; minima-xor(A, swap mask)
pxor    MM1, MM2    ; maxima-xor(B, swap mask)
psubw   MM1, MM4    ; absolute difference =
                    ; maxima-minima

```

Absolute Value

Use Example 4-18 to compute $|x|$, where x is signed. This example assumes signed words to be the operands.

Example 4-18 Computing Absolute Value

```
; Input:
;     MM0          signed source operand
; Output:
;     MM1          ABS(MM0)
pxor  MM1, MM1    ; set MM1 to all zeros
psubw MM1, MM0    ; make each MM1 word contain the
                  ; negative of each MM0 word
pmaxsw MM1, MM0   ; MM1 will contain only the positive
                  ; (larger) values - the absolute value
```



CAUTION. *The absolute value of the most negative number (that is, 8000 hex for 16-bit) cannot be represented using positive numbers. This algorithm will return the original value for the absolute value (8000 hex).*

Clipping to an Arbitrary Range [high, low]

This section explains how to clip a values to a range [high, low]. Specifically, if the value is less than low or greater than high, then clip to low or high, respectively. This technique uses the packed-add and packed-subtract instructions with saturation (signed or unsigned), which means that this technique can only be used on packed-byte and packed-word data types.

The examples in this section use the constants `packed_max` and `packed_min` and show operations on word values. For simplicity we use the following constants (corresponding constants are used in case the operation is done on byte values):

- `packed_max` equals `0x7fff7fff7fff7fff`

- `packed_min` equals `0x8000800080008000`
- `packed_low` contains the value `low` in all four words of the `packed-words` data type
- `packed_high` contains the value `high` in all four words of the `packed-words` data type
- `packed_usmax` all values equal `1`
- `high_us` adds the `high` value to all data elements (4 words) of `packed_min`
- `low_us` adds the `low` value to all data elements (4 words) of `packed_min`

Highly Efficient Clipping

For clipping signed words to an arbitrary range, the `pmaxsw` and `pminsw` instructions may be used. For clipping unsigned bytes to an arbitrary range, the `pmaxub` and `pminub` instructions may be used. Example 4-19 shows how to clip signed words to an arbitrary range; the code for clipping unsigned bytes is similar.

Example 4-19 Clipping to a Signed Range of Words [high, low]

```
; Input:
;      MM0      signed source operands
; Output:
;      MM0      signed words clipped to the signed
;               range [high, low]

pminsw MM0, packed_high
pmaxsw MM0, packed_low
```

Example 4-20 Clipping to an Arbitrary Signed Range [high, low]

```
; Input:
;     MM0             signed source operands
; Output:
;     MM1             signed operands clipped to the unsigned
;                     range [high, low]

paddw  MM0, packed_min ; add with no saturation
                          ; 0x8000 to convert to unsigned
paddusw MM0, (packed_usmax - high_us)
                          ; in effect this clips to high
psubusw MM0, (packed_usmax - high_us + low_us)
                          ; in effect this clips to low
paddw  MM0, packed_low  ; undo the previous two offsets
```

The code above converts values to unsigned numbers first and then clips them to an unsigned range. The last instruction converts the data back to signed data and places the data within the signed range. Conversion to unsigned data is required for correct results when $(high - low) < 0x8000$.

If $(high - low) \geq 0x8000$, the algorithm can be simplified as shown in Example 4-21.

Example 4-21 Simplified Clipping to an Arbitrary Signed Range

```
; Input:  MM0             signed source operands
; Output: MM1             signed operands clipped to the unsigned
;                     range [high, low]
paddssw  MM0, (packed_max - packed_high)
                          ; in effect this clips to high
psubssw  MM0, (packed_usmax - packed_high + packed_ow)
                          ; clips to low
paddw    MM0, low        ; undo the previous two offsets
```

This algorithm saves a cycle when it is known that $(high - low) \geq 0x8000$. The three-instruction algorithm does not work when $(high - low) < 0x8000$, because $0xffff$ minus any number $< 0x8000$ will yield a number greater in magnitude than $0x8000$, which is a negative number. When the second instruction, `psubssw MM0, (0xffff - high + low)`, in the three-step algorithm (Example 4-21) is executed, a negative number is subtracted. The result of this subtraction causes the values in `MM0` to be increased instead of decreased, as should be the case, and an incorrect answer is generated.

Clipping to an Arbitrary Unsigned Range [high, low]

The code in Chapter 4 clips an unsigned value to the unsigned range `[high, low]`. If the value is less than `low` or greater than `high`, then clip to `low` or `high`, respectively. This technique uses the packed-add and packed-subtract instructions with unsigned saturation, thus this technique can only be used on packed-bytes and packed-words data types.

The example illustrates the operation on word values.

Example 4-22 Clipping to an Arbitrary Unsigned Range [high, low]

```

; Input:
;           MM0      unsigned source operands
; Output:
;           MM1      unsigned operands clipped to the unsigned
;                   range [HIGH, LOW]
paddusw    MM0, 0xffff - high
           ; in effect this clips to high
psubusw    MM0, (0xffff - high + low)
           ; in effect this clips to low
paddw      MM0, low
           ; undo the previous two offsets
    
```

Packed Max/Min of Signed Word and Unsigned Byte

Signed Word

The `pmaxsw` instruction returns the maximum between the four signed words in either two SIMD registers, or one SIMD register and a memory location.

The `pminsw` instruction returns the minimum between the four signed words in either two SIMD registers, or one SIMD register and a memory location.

Unsigned Byte

The `pmaxub` instruction returns the maximum between the eight unsigned bytes in either two SIMD registers, or one SIMD register and a memory location.

The `pminub` instruction returns the minimum between the eight unsigned bytes in either two SIMD registers, or one SIMD register and a memory location.

Packed Multiply High Unsigned

The `pmulhuw` and `pmulhw` instruction multiplies the unsigned/signed words in the destination operand with the unsigned/signed words in the source operand. The high-order 16 bits of the 32-bit intermediate results are written to the destination operand.

Packed Sum of Absolute Differences

The `psadbw` instruction (see Figure 4-9) computes the absolute value of the difference of unsigned bytes for either two SIMD registers, or one SIMD register and a memory location. These differences are then summed to produce a word result in the lower 16-bit field, and the upper three words are set to zero.

Figure 4-9 PSADBW Instruction Example

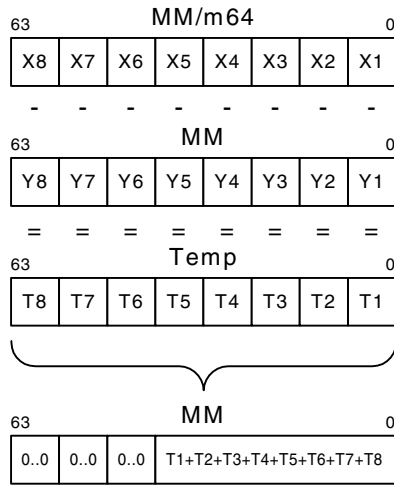

OM15167

The subtraction operation presented above is an absolute difference, that is, $t = \text{abs}(x - y)$. The byte values are stored in temporary space, all values are summed together, and the result is written into the lower word of the destination register.

Packed Average (Byte/Word)

The `pavgb` and `pavgw` instructions add the unsigned data elements of the source operand to the unsigned data elements of the destination register, along with a carry-in. The results of the addition are then each independently shifted to the right by one bit position. The high order bits of each element are filled with the carry bits of the corresponding sum.

The destination operand is an SIMD register. The source operand can either be an SIMD register or a memory operand.

The `PAVGB` instruction operates on packed unsigned bytes and the `PAVGW` instruction operates on packed unsigned words.

Complex Multiply by a Constant

Complex multiplication is an operation which requires four multiplications and two additions. This is exactly how the `pmaddwd` instruction operates. In order to use this instruction, you need to format the data into multiple 16-bit values. The real and imaginary components should be 16-bits each. Consider Example 4-23, which assumes that the 64-bit MMX registers are being used:

- Let the input data be D_r and D_i where D_r is real component of the data and D_i is imaginary component of the data.
- Format the constant complex coefficients in memory as four 16-bit values $[C_r \ -C_i \ C_i \ C_r]$. Remember to load the values into the MMX register using a `movq` instruction.
- The real component of the complex product is

$$P_r = D_r * C_r - D_i * C_i$$

and the imaginary component of the complex product is

$$P_i = D_r * C_i + D_i * C_r.$$

Example 4-23 Complex Multiply by a Constant

```
; Input:
;          MM0          complex value, Dr, Di
;          MM1          constant complex coefficient in the form
;                      [Cr -Ci Ci Cr]
; Output:
;          MM0          two 32-bit dwords containing [Pr Pi]
;
punpckldq  MM0, MM0    ; makes [Dr Di Dr Di]
pmaddwd   MM0, MM1    ; done, the result is
;                      [(Dr*Cr-Di*Ci) (Dr*Ci+Di*Cr)]
```

Note that the output is a packed doubleword. If needed, a pack instruction can be used to convert the result to 16-bit (thereby matching the format of the input).

Packed 32*32 Multiply

The `PMULUDQ` instruction performs an unsigned multiply on the lower pair of double-word operands within each 64-bit chunk from the two sources; the full 64-bit result from each multiplication is returned to the destination register. This instruction is added in both a 64-bit and 128-bit version; the latter performs 2 independent operations, on the low and high halves of a 128-bit register.

Packed 64-bit Add/Subtract

The `PADDQ/PSUBQ` instructions add/subtract quad-word operands within each 64-bit chunk from the two sources; the 64-bit result from each computation is written to the destination register. Like the integer `ADD/SUB` instruction, `PADDQ/PSUBQ` can operate on either unsigned or signed (two's complement notation) integer operands. When an individual result is too large to be represented in 64-bits, the lower 64-bits of the result are written to the destination operand and therefore the result wraps around. These instructions are added in both a 64-bit and 128-bit version; the latter performs 2 independent operations, on the low and high halves of a 128-bit register.

128-bit Shifts

The `PSLLDQ/PSRLDQ` instructions shift the first operand to the left/right by the amount of bytes specified by the immediate operand. The empty low/high-order bytes are cleared (set to zero). If the value specified by the immediate operand is greater than 15, then the destination is set to all zeros.

Memory Optimizations

You can improve memory accesses using the following techniques:

- Avoiding partial memory accesses
- Increasing the bandwidth of memory fills and video fills
- Prefetching data with Streaming SIMD Extensions (see Chapter 6, “Optimizing Cache Usage”).

The MMX registers and XMM registers allow you to move large quantities of data without stalling the processor. Instead of loading single array values that are 8, 16, or 32 bits long, consider loading the values in a single quadword or double quadword, then incrementing the structure or array pointer accordingly.

Any data that will be manipulated by SIMD integer instructions should be loaded using either:

- the SIMD integer instruction that loads a 64-bit or 128-bit operand (for example, `movq MM0, m64`)
- the register-memory form of any SIMD integer instruction that operates on a quadword or double quadword memory operand (for example, `pmaddw MM0, m64`).

All SIMD data should be stored using the SIMD integer instruction that stores a 64-bit or 128-bit operand (for example, `movq m64, MM0`)

The goal of these recommendations is twofold. First, the loading and storing of SIMD data is more efficient using the larger block sizes. Second, this helps to avoid the mixing of 8-, 16-, or 32-bit load and store operations with SIMD integer technology load and store operations to the same SIMD data. This, in turn, prevents situations in which small loads follow large stores to the same area of memory, or large loads follow small stores to the same area of memory. The Pentium II, Pentium III, and Pentium 4 processors stall in these situations; see Chapter 2, “General Optimization Guidelines” for more details.

Partial Memory Accesses

Consider a case with large load after a series of small stores to the same area of memory (beginning at memory address `mem`). The large load will stall in this case as shown in Example 4-24.

Example 4-24 A Large Load after a Series of Small Stores (Penalty)

```

mov    mem, eax        ; store dword to address "mem"
mov    mem + 4, ebx    ; store dword to address "mem + 4"
:
:
movq   mm0, mem        ; load qword at address "mem", stalls

```

The `movq` must wait for the stores to write memory before it can access all the data it requires. This stall can also occur with other data types (for example, when bytes or words are stored and then words or doublewords are read from the same area of memory). When you change the code sequence as shown in Example 4-25, the processor can access the data without delay.

Example 4-25 Accessing Data without Delay

```

movd   mm1, ebx        ; build data into a qword first
                                ; before storing it to memory

movd   mm2, eax
psllq  mm1, 32
por    mm1, mm2
movq   mem, mm1        ; store SIMD variable to "mem" as
                                ; a qword
:
:
movq   mm0, mem        ; load qword SIMD "mem", no stall

```

Let us now consider a case with a series of small loads after a large store to the same area of memory (beginning at memory address `mem`) as shown in Example 4-26. Most of the small loads will stall because they are not aligned with the store; see “Store Forwarding” in Chapter 2 for more details.

Example 4-26 A Series of Small Loads after a Large Store

```
movq    mem, mm0      ; store qword to address "mem"
      :
      :
mov     bx, mem + 2   ; load word at "mem + 2" stalls
mov     cx, mem + 4   ; load word at "mem + 4" stalls
```

The word loads must wait for the quadword store to write to memory before they can access the data they require. This stall can also occur with other data types (for example, when doublewords or words are stored and then words or bytes are read from the same area of memory). When you change the code sequence as shown in Example 4-27, the processor can access the data without delay.

Example 4-27 Eliminating Delay for a Series of Small Loads after a Large Store

```
movq    mem, mm0      ; store qword to address "mem"
      :
      :
movq    mm1, mem      ; load qword at address "mem"
movd    eax, mm1      ; transfer "mem + 2" to eax from
                        ; MMX register, not memory
psrlq   mm1, 32
shr     eax, 16
movd    ebx, mm1      ; transfer "mem + 4" to bx from
                        ; MMX register, not memory
and     ebx, 0ffffh
```

These transformations, in general, increase the number of instructions required to perform the desired operation. For Pentium II, Pentium III, and Pentium 4 processors, the benefit of avoiding forwarding problems outweighs the performance penalty due to the increased number of instructions, making the transformations worthwhile.

Increasing Bandwidth of Memory Fills and Video Fills

It is beneficial to understand how memory is accessed and filled. A memory-to-memory fill (for example a memory-to-video fill) is defined as a 64-byte (cache line) load from memory which is immediately stored back to memory (such as a video frame buffer). The following are guidelines for obtaining higher bandwidth and shorter latencies for sequential memory fills (video fills). These recommendations are relevant for all Intel architecture processors with MMX technology and refer to cases in which the loads and stores do not hit in the first- or second-level cache.

Increasing Memory Bandwidth Using the MOVDQ Instruction

Loading any size data operand will cause an entire cache line to be loaded into the cache hierarchy. Thus any size load looks more or less the same from a memory bandwidth perspective. However, using many smaller loads consumes more microarchitectural resources than fewer larger stores. Consuming too many of these resources can cause the processor to stall and reduce the bandwidth that the processor can request of the memory subsystem.

Using `movdq` to store the data back to UC memory (or WC memory in some cases) instead of using 32-bit stores (for example, `movd`) will reduce by three-quarters the number of stores per memory fill cycle. As a result, using the `movdq` instruction in memory fill cycles can achieve significantly higher effective bandwidth than using the `movd` instruction.

Increasing Memory Bandwidth by Loading and Storing to and from the Same DRAM Page

DRAM is divided into pages, which are not the same as operating system (OS) pages. The size of a DRAM page is a function of the total size of the DRAM and the organization of the DRAM. Page sizes of several Kilobytes are common. Like OS pages, DRAM pages are constructed of sequential addresses. Sequential memory accesses to the same DRAM page have shorter latencies than sequential accesses to different DRAM pages. In many systems the latency for a page miss (that is, an access to a different page instead of the page previously accessed) can be twice as large as the latency of a memory page hit (access to the same page as the previous access). Therefore, if the loads and stores of the memory fill cycle are to the same DRAM page, a significant increase in the bandwidth of the memory fill cycles can be achieved.

Increasing UC and WC Store Bandwidth by Using Aligned Stores

Using aligned stores to fill UC or WC memory will yield higher bandwidth than using unaligned stores. If a UC store or some WC stores cross a cache line boundary, a single store will result in two transactions on the bus, reducing the efficiency of the bus transactions. By aligning the stores to the size of the stores, you eliminate the possibility of crossing a cache line boundary, and the stores will not be split into separate transactions.

Converting from 64-bit to 128-bit SIMD Integer

The SSE2 define a superset of 128-bit integer instructions currently available in MMX technology; the operation of the extended instructions remains the same and simply operate on data that is twice as wide. This simplifies porting of current 64-bit integer applications. However, there are few additional considerations:

- Computation instructions which use a memory operand that may not be aligned to a 16-byte boundary must be replaced with an unaligned 128-bit load (`movdqu`) followed by the same computation operation that uses instead register operands. Use of 128-bit integer computation instructions with memory operands that are not 16-byte aligned will result in a General Protection fault. The unaligned 128-bit load and store is not as efficient as the corresponding aligned versions; this can reduce the performance gains when using the 128-bit SIMD integer extensions. The general guidelines on the alignment of memory operands are:
 - The greatest performance gains can be achieved when all memory streams are 16-byte aligned.
 - Reasonable performance gains are possible if roughly half of all memory streams are 16-byte aligned, and the other half are not.
 - Little or no performance gain may result if all memory streams are not aligned to 16-bytes; in this case, use of the 64-bit SIMD integer instructions may be preferable.
- Loop counters need to be updated because each 128-bit integer instruction operates on twice the amount of data as the 64-bit integer counterpart.
- Extension of the `pshufw` instruction (shuffle word across 64-bit integer operand) across a full 128-bit operand is emulated by a combination of the following instructions: `pshufhw`, `pshufw`, `pshufd`.
- Use of the 64-bit shift by bit instructions (`psrlq`, `psllq`) are extended to 128 bits in these ways:
 - use of `psrlq` and `psllq`, along with masking logic operations
 - code sequence is rewritten to use the `psrldq` and `pslldq` instructions (shift double quad-word operand by bytes).

Optimizing for SIMD Floating-point Applications

5

This chapter discusses general rules of optimizing for the single-instruction, multiple-data (SIMD) floating-point instructions available in Streaming SIMD Extensions (SSE) and Streaming SIMD Extensions 2 (SSE2). This chapter also provides examples that illustrate the optimization techniques for single-precision and double-precision SIMD floating-point applications.

General Rules for SIMD Floating-point Code

The rules and suggestions listed in this section help optimize floating-point code containing SIMD floating-point instructions. Generally, it is important to understand and balance port utilization to create efficient SIMD floating-point code. The basic rules and suggestions include the following:

- Follow all guidelines in Chapter 2 and Chapter 3.
- Exceptions: mask exceptions to achieve higher performance. When exceptions are unmasked, software performance is slower.
- Utilize the flush-to-zero mode for higher performance to avoid the penalty of dealing with denormals and underflows.
- Incorporate the prefetch instruction whenever possible (for details, refer to Chapter 6, “Optimizing Cache Usage”).
- Use MMX technology instructions and registers if the computations can be done in SIMD integer for shuffling data.
- Use MMX technology instructions and registers or for copying data that is not used later in SIMD floating-point computations.

- Use the reciprocal instructions followed by iteration for increased accuracy. These instructions yield reduced accuracy but execute much faster. Note the following:
 - If reduced accuracy is acceptable, use them with no iteration.
 - If near full accuracy is needed, use a Newton-Raphson iteration.
 - If full accuracy is needed, then use divide and square root which provide more accuracy, but slow down performance.

Planning Considerations

Whether adapting an existing application or creating a new one, using SIMD floating-point instructions to achieve optimum performance gain requires programmers to consider several issues. In general, when choosing candidates for optimization, look for code segments that are computationally intensive and floating-point intensive. Also consider efficient use of the cache architecture.

The sections that follow answer the questions that should be raised before implementation:

- Which part of the code benefits from SIMD floating-point instructions?
- Is the current algorithm the most appropriate for SIMD floating-point instructions?
- Is the code floating-point intensive?
- Do either single-precision floating-point or double-precision floating-point computations provide enough range and precision?
- Is the data arranged for efficient utilization of the SIMD floating-point registers?
- Is this application targeted for processors without SIMD floating-point instructions?

For more details, see the section on “Considerations for Code Conversion to SIMD Programming” in Chapter 3.

Detecting SIMD Floating-point Support

Applications must be able to determine if SSE are available. Please refer the section “Checking for Processor Support of SIMD Technologies” in Chapter 3 for the techniques to determine whether the processor and operating system support SSE.

Using SIMD Floating-point with x87 Floating-point

Because the XMM registers used for SIMD floating-point computations are separate registers and are not mapped onto the existing x87 floating-point stack, SIMD floating-point code can be mixed with either x87 floating-point or 64-bit SIMD integer code.

Scalar Floating-point Code

There are SIMD floating-point instructions that operate only on the least-significant operand in the SIMD register. These instructions are known as scalar instructions. They allow the XMM registers to be used for general-purpose floating-point computations.

In terms of performance, scalar floating-point code can be equivalent to or exceed x87 floating-point code, and has the following advantages:

- SIMD floating-point code uses a flat register model, whereas x87 floating-point code uses a stack model. Using scalar floating-point code eliminates the need to use `fxch` instructions, which has some performance limit on the Intel Pentium 4 processor.
- Mixing with MMX technology code without penalty.
- Flush-to-zero mode.
- Shorter latencies than x87 floating-point.

When using scalar floating-point instructions, it is not necessary to ensure that the data appears in vector form. However, all of the optimizations regarding alignment, scheduling, instruction selection, and other optimizations covered in Chapters 2 and 3 should be observed.

Data Alignment

SIMD floating-point data is 16-byte aligned. Referencing unaligned 128-bit SIMD floating-point data will result in an exception unless the `movups` or `movupd` (move unaligned packed single or unaligned packed double) instruction is used. The unaligned instructions used on aligned or unaligned data will also suffer a performance penalty relative to aligned accesses.

Refer to section “Stack and Data Alignment” in Chapter 3 for more information.

Data Arrangement

Because the SSE and SSE2 incorporate a SIMD architecture, arranging the data to fully use the SIMD registers produces optimum performance. This implies contiguous data for processing, which leads to fewer cache misses and can potentially quadruple the data throughput when using SSE, or twice the throughput when using SSE2. These performance gains can occur because four data element can be loaded with 128-bit load instructions into XMM registers using SSE (`movaps` – move aligned packed single precision). Similarly, two data element can loaded with 128-bit load instructions into XMM registers using SSE2 (`movapd` – move aligned packed double precision).

Refer to the “Stack and Data Alignment” in Chapter 3 for data arrangement recommendations. Duplicating and padding techniques overcome the misalignment problem that can occur in some data structures and arrangements. This increases the data space but avoids the expensive penalty for misaligned data access.

For some applications, the traditional data arrangement requires some changes to fully utilize the SIMD registers and parallel techniques. Traditionally, the data layout has been an array of structures (AoS). To fully utilize the SIMD registers, a new data layout has been proposed—a structure of arrays (SoA) resulting in more optimized performance.

Vertical versus Horizontal Computation

Traditionally, the AoS data structure is used in 3D geometry computations. SIMD technology can be applied to AoS data structure using a horizontal computation technique. This means that the x , y , z , and w components of a single vertex structure (that is, of a single vector simultaneously referred to as an xyz data representation, see the diagram below) are computed in parallel, and the array is updated one vertex at a time.



To optimally utilize the SIMD registers, the data structure can be organized in the SoA format. The SoA data structure enables a vertical computation technique, and is recommended over horizontal computation, for the following reasons:

- When computing on a single vector (xyz), it is common to use only a subset of the vector components; for example, in 3D graphics the w component is sometimes ignored. This means that for single-vector operations, 1 of 4 computation slots is not being utilized. This typically results in a 25% reduction of peak efficiency.
- It may become difficult to hide long latency operations. For instance, another common function in 3D graphics is normalization, which requires the computation of a reciprocal square root (that is, $1/\text{sqrt}$). Both the division and square root are long latency operations. With vertical computation (SoA), each of the 4 computation slots in a SIMD operation is producing a unique result,

so the net latency per slot is $L/4$ where L is the overall latency of the operation. However, for horizontal computation, the 4 computation slots each produce the same result, hence to produce 4 separate results requires a net latency per slot of L .

To utilize all 4 computation slots, the vertex data can be reorganized to allow computation on each component of 4 separate vertices, that is, processing multiple vectors simultaneously. This can also be referred to as an SoA form of representing vertices data shown in Table 5-1.

Table 5-1 SoA Form of Representing Vertices Data

Vx array	X1	X2	X3	X4	Xn
Vy array	Y1	Y2	Y3	Y4	Yn
Vz array	Z1	Z2	Z3	Y4	Zn
Vw array	W1	W2	W3	W4	Wn

Organizing data in this manner yields a unique result for each computational slot for each arithmetic operation.

Vertical computation takes advantage of the inherent parallelism in 3D geometry processing of vertices. It assigns the computation of four vertices to the four compute slots of the Pentium III processor, thereby eliminating the disadvantages of the horizontal approach described earlier. The dot product operation implements the SoA representation of vertices data. A schematic representation of dot product operation is shown in Figure 5-1.

Figure 5-1 Dot Product Operation

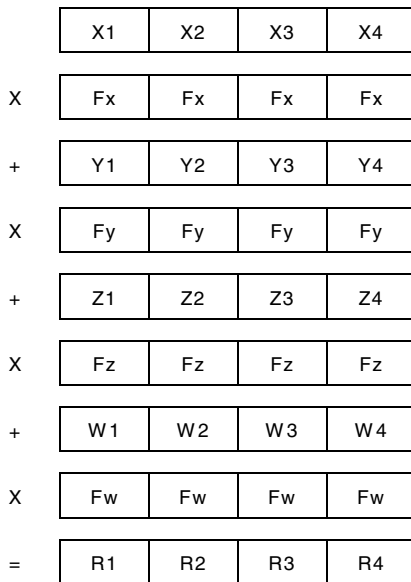

OM15168

Figure 5-1 shows how 1 result would be computed for 7 instructions if the data were organized as AoS: 4 results would require 28 instructions.

Example 5-1 Pseudocode for Horizontal (xyz, AoS) Computation

```
mulps      ; x*x', y*y', z*z'  
movaps     ; reg->reg move, since next steps overwrite  
shufps    ; get b,a,d,c from a,b,c,d  
addps     ; get a+b,a+b,c+d,c+d  
movaps     ; reg->reg move  
shufps    ; get c+d,c+d,a+b,a+b from prior addps  
addps     ; get a+b+c+d,a+b+c+d,a+b+c+d,a+b+c+d
```

Now consider the case when the data is organized as SoA. Example 5-2 demonstrates how 4 results are computed for 5 instructions.

Example 5-2 Pseudocode for Vertical (xxxx, yyyy, zzzz, SoA) Computation

```
mulps     ; x*x' for all 4 x-components of 4 vertices  
mulps     ; y*y' for all 4 y-components of 4 vertices  
mulps     ; z*z' for all 4 z-components of 4 vertices  
addps     ; x*x' + y*y'  
addps     ; x*x' + y*y' + z*z'
```

For the most efficient use of the four component-wide registers, reorganizing the data into the SoA format yields increased throughput and hence much better performance for the instructions used.

As can be seen from this simple example, vertical computation yielded 100% use of the available SIMD registers and produced 4 results. (The results may vary based on the application.) If the data structures must be in a format that is not “friendly” to vertical computation, it can be rearranged “on the fly” to achieve full utilization of the SIMD registers. This operation is referred to as “swizzling” operation and the reverse operation is referred to as “deswizzling.”

Data Swizzling

Swizzling data from one format to another is required in many algorithms. An example of this is AoS format, where the vertices come as *xyz* adjacent coordinates. Rearranging them into SoA format, *xxxx*, *yyyy*, *zzzz*, allows more efficient SIMD computations. For efficient data shuffling and swizzling use the following instructions:

- `movlps`, `movhps` load/store and move data on half sections of the registers
- `shufps`, `unpackhps`, and `unpacklps` unpack data

To gather data from 4 different memory locations on the fly, follow steps:

1. Identify the first half of the 128-bit memory location.
2. Group the different halves together using the `movlps` and `movhps` to form an *xyxy* layout in two registers.
3. From the 4 attached halves, get the *xxxx* by using one shuffle, the *yyyy* by using another shuffle.

The *zzzz* is derived the same way but only requires one shuffle.

Example 5-3 illustrates the swizzle function.

Example 5-3 Swizzling Data

```
typedef struct _VERTEX_AOS {
    float x, y, z, color;
} Vertex_aos;           // AoS structure declaration
typedef struct _VERTEX_SOA {
    float x[4], float y[4], float z[4];
    float color[4];
} Vertex_soa;          // SoA structure declaration
```

continued

Example 5-3 Swizzling Data (continued)

```

void swizzle_asm (Vertex_aos *in, Vertex_soa *out)
{
// in mem: x1y1z1w1-x2y2z2w2-x3y3z3w3-x4y4z4w4-
// SWIZZLE XYZW --> XXXX
asm {
    mov ecx, in                // get structure addresses
    mov edx, out

y1 x1
    movhps xmm7, [ecx+16]     // xmm7 = y2 x2 y1 x1
    movlps xmm0, [ecx+32]     // xmm0 = -- -- y3 x3
    movhps xmm0, [ecx+48]     // xmm0 = y4 x4 y3 x3
    movaps xmm6, xmm7         // xmm6 = y1 x1 y1 x1
    shufps xmm7, xmm0, 0x88   // xmm7 = x1 x2 x3 x4 => X
    shufps xmm6, xmm0, 0xDD   // xmm6 = y1 y2 y3 y4 => Y
    movlps xmm2, [ecx+8]      // xmm2 = -- -- w1 z1
    movhps xmm2, [ecx+24]     // xmm2 = w2 z2 u1 z1
    movlps xmm1, [ecx+40]     // xmm1 = -- -- s3 z3
    movhps xmm1, [ecx+56]     // xmm1 = w4 z4 w3 z3
    movaps xmm0, xmm2         // xmm0 = w1 z1 w1 z1
    shufps xmm2, xmm1, 0x88   // xmm2 = z1 z2 z3 z4 => Z
    movlps xmm7, [ecx]        // xmm7 = -- --shufps xmm0, xmm1,
    // 0xDD xmm6 = w1 w2 w3 w4 => W

```

continued

Example 5-3 Swizzling Data (continued)

```

movaps [edx], xmm7      // store X
movaps [edx+16], xmm6   // store Y
movaps [edx+32], xmm2   // store Z
movaps [edx+48], xmm0   // store W
                        // SWIZZLE XYZ -> XXX
    }
}
    
```

Example 5-4 shows the same data -swizzling algorithm encoded using the Intel® C++ Compiler's intrinsics for SSE.

Example 5-4 Swizzling Data Using Intrinsics

```

//Intrinsics version of data swizzle
void swizzle_intrin (Vertex_aos *in, Vertex_soa *out, int stride)
{
    __m128 x, y, z, w;
    __m128 tmp;
    x = _mm_loadl_pi(x, (__m64 *) (in));
    x = _mm_loadh_pi(x, (__m64 *) (stride + (char *) (in)));
    y = _mm_loadl_pi(y, (__m64 *) (2*stride+(char *) (in)));
    y = _mm_loadh_pi(y, (__m64 *) (3*stride+(char *) (in)));
    tmp = _mm_shuffle_ps( x, y, _MM_SHUFFLE( 2, 0, 2, 0));
    y = _mm_shuffle_ps( x, y, _MM_SHUFFLE( 3, 1, 3, 1));
    x = tmp;
    z = _mm_loadl_pi(z, (__m64 *) (8 + (char *) (in)));
    z = _mm_loadh_pi(z, (__m64 *) (stride+8+(char *) (in)));
    w = _mm_loadl_pi(w, (__m64 *) (2*stride+8+(char*) (in)));
    w = _mm_loadh_pi(w, (__m64 *) (3*stride+8+(char*) (in)));
}
    
```

continued

Example 5-4 Swizzling Data Using Intrinsics (continued)

```
tmp = _mm_shuffle_ps( z, w, _MM_SHUFFLE( 2, 0, 2, 0));
w = _mm_shuffle_ps( z, w, _MM_SHUFFLE( 3, 1, 3, 1));
z = tmp;
_mm_store_ps(&out->x[0], x);
_mm_store_ps(&out->y[0], y);
_mm_store_ps(&out->z[0], z);
_mm_store_ps(&out->w[0], w);
}
```



CAUTION. *Avoid creating a dependence chain from previous computations because the `movhps/movlps` instructions bypass one part of the register. The same issue can occur with the use of an exclusive-OR function within an inner loop in order to clear a register:*

```
xorps xmm0, xmm0 ; All 0's written to xmm0
```

Although the generated result of all zeros does not depend on the specific data contained in the source operand (that is, XOR of a register with itself always produces all zeros), the instruction cannot execute until the instruction that generates `xmm0` has completed. In the worst case, this creates a dependence chain that links successive iterations of the loop, even if those iterations are otherwise independent. The performance impact can be significant depending on how many other independent intra-loop computations are performed. Note that on the Pentium 4 processor, the SIMD integer `pxor` instructions, if used with the same register, do break the dependence chain, eliminating false dependencies when clearing registers.

The same situation can occur for the above `movhps/movlps/shufps` sequence. Since each `movhps/movlps` instruction bypasses part of the destination register, the instruction cannot execute until the prior instruction that generates this register has completed. As with the `xorps` example, in the worst case this dependence can prevent successive loop iterations from executing in parallel.

A solution is to include a 128-bit load (that is, from a dummy local variable, such as `tmp` in Example 5-4) to each register to be used with a `movhps/movlps` instruction. This action effectively breaks the dependence by performing an independent load from a memory or cached location.

Data Deswizzling

In the deswizzle operation, we want to arrange the SoA format back into AoS format so the `xxxx, yyyy, zzzz` are rearranged and stored in memory as `xyz`. To do this we can use the `unpcklps/unpckhps` instructions to regenerate the `xyxy` layout and then store each half (`xy`) into its corresponding memory location using `movlps/movhps` followed by another `movlps/movhps` to store the `z` component.

Example 5-5 illustrates the deswizzle function:

Example 5-5 Deswizzling Single-Precision SIMD Data

```
void deswizzle_asm(Vertex_soa *in, Vertex_aos *out)
{
    __asm {
        mov     ecx, in           // load structure addresses
        mov     edx, out
        movaps  xmm7, [ecx]      // load x1 x2 x3 x4 => xmm7
        movaps  xmm6, [ecx+16]   // load y1 y2 y3 y4 => xmm6
        movaps  xmm5, [ecx+32]   // load z1 z2 z3 z4 => xmm5
        movaps  xmm4, [ecx+48]   // load w1 w2 w3 w4 => xmm4
```

continued

Example 5-5 Deswizzling Single-Precision SIMD Data (continued)

```
// START THE DESWIZZLING HERE
    movaps    xmm0, xmm7        // xmm0= x1 x2 x3 x4
    unpkhps  xmm7, xmm6        // xmm7= x1 y1 x2 y2
    movlps   [edx], xmm7      // v1 = x1 y1 -- --
    movhps   [edx+16], xmm7    // v2 = x2 y2 -- --
    unpckhps xmm0, xmm6        // xmm0= x3 y3 x4 y4
    movlps   [edx+32], xmm0    // v3 = x3 y3 -- --
    movhps   [edx+48], xmm0    // v4 = x4 y4 -- --
    movaps   xmm0, xmm5        // xmm0= z1 z2 z3 z4
unpcklps  xmm5, xmm4          // xmm5= z1 w1 z2 w2
    unpckhps xmm0, xmm4        // xmm0= z3 w3 z4 w4
    movlps   [edx+8], xmm5     // v1 = x1 y1 z1 w1
    movhps   [edx+24], xmm5    // v2 = x2 y2 z2 w2
    movlps   [edx+40], xmm0    // v3 = x3 y3 z3 w3
    movhps   [edx+56], xmm0    // v4 = x4 y4 z4 w4
// DESWIZZLING ENDS HERE
    }
}
```

You may have to swizzle data in the registers, but not in memory. This occurs when two different functions need to process the data in different layout. In lighting, for example, data comes as `rrrr gggg bbbb aaaa`, and you must deswizzle them into `rgba` before converting into integers. In this case you use the `movlhps/movhlps` instructions to do the first part of the deswizzle followed by `shuffle` instructions, see Example 5-6 and Example 5-7.

Example 5-6 Deswizzling Data Using the movlhps and shuffle Instructions

```

void deswizzle_rgb(Vertex_soa *in, Vertex_aos *out)
{
    //---deswizzle rgb---
    // assume: xmm1=rrrr, xmm2=gggg, xmm3=bbbb, xmm4=aaaa
    __asm {
        mov     ecx, in           // load structure addresses
        mov     edx, out
        movaps xmm1, [ecx]       // load r1 r2 r3 r4 => xmm1
        movaps xmm2, [ecx+16]    // load g1 g2 g3 g4 => xmm2
        movaps xmm3, [ecx+32]    // load b1 b2 b3 b4 => xmm3
        movaps xmm4, [ecx+48]    // load a1 a2 a3 a4 => xmm4
    // Start deswizzling here
        movaps xmm7, xmm4        // xmm7= a1 a2 a3 a4
        movhps xmm7, xmm3        // xmm7= b3 b4 a3 a4
        movaps xmm6, xmm2        // xmm6= g1 g2 g3 g4
        movhps xmm3, xmm4        // xmm3= b1 b2 a1 a2
        movhps xmm2, xmm1        // xmm2= r3 r4 g3 g4
        movhps xmm1, xmm6        // xmm1= r1 r2 g1 g2
        movaps xmm6, xmm2        // xmm6= r3 r4 g3 g4
        movaps xmm5, xmm1        // xmm5= r1 r2 g1 g2
        shufps xmm2, xmm7, 0xDD // xmm2= r4 g4 b4 a4
        shufps xmm1, xmm3, 0x88 // xmm4= r1 g1 b1 a1
        shufps xmm5, xmm3, 0x88 // xmm5= r2 g2 b2 a2
        shufps xmm6, xmm7, 0xDD // xmm6= r3 g3 b3 a3
        movaps [edx], xmm4       // v1 = r1 g1 b1 a1
        movaps [edx+16], xmm5    // v2 = r2 g2 b2 a2
        movaps [edx+32], xmm6    // v3 = r3 g3 b3 a3
        movaps [edx+48], xmm2    // v4 = r4 g4 b4 a4
    // DESWIZZLING ENDS HERE
    }
}
    
```

Example 5-7 Deswizzling Data 64-bit Integer SIMD Data

```
void mmx_deswizzle(IVertex_soa *in, IVertex_aos *out)
{
    __asm {
        mov     ebx, in
        mov     edx, out
        movq   mm0, [ebx]           // mm0= u1 u2
        movq   mm1, [ebx+16]       // mm1= v1 v2
        movq   mm2, mm0           // mm2= u1 u2
        punpckhdq mm0, mm1       // mm0= u1 v1
        punpckldq mm2, mm1       // mm0= u2 v2
        movq   [edx], mm2         // store u1 v1
        movq   [edx+8], mm0       // store u2 v2
        movq   mm4, [ebx+8]       // mm0= u3 u4
        movq   mm5, [ebx+24]      // mm1= v3 v4
        movq   mm6, mm4           // mm2= u3 u4
        punpckhdq mm4, mm5       // mm0= u3 v3
        punpckldq mm6, mm5       // mm0= u4 v4
        movq   [edx+16], mm6      // store u3v3
        movq   [edx+24], mm4      // store u4v4
    }
}
```

Using MMX Technology Code for Copy or Shuffling Functions

If there are some parts in the code that are mainly copying, shuffling, or doing logical manipulations that do not require use of SSE code, consider performing these actions with MMX technology code. For example, if texture data is stored in memory as SoA (uuuu, vvvv) and they need only to be deswizzled into AoS layout (uv) for the graphic

cards to process, you can use either the SSE or MMX technology code. Using the MMX instructions allow you to conserve XMM registers for other computational tasks.

Example 5-8 illustrates how to use MMX technology code for copying or shuffling.

Example 5-8 Using MMX Technology Code for Copying or Shuffling

```

movq      mm0, [Uarray+ebx]      ; mm0= u1 u2
movq      mm1, [Varray+ebx]      ; mm1= v1 v2
movq      mm2, mm0               ; mm2= u1 u2
punpckhdq mm0, mm1              ; mm0= u1 v1
punpckldq mm2, mm1              ; mm2= u2 v2
movq      [Coords+edx], mm0      ; store u1 v1
movq      [Coords+8+edx], mm2    ; store u2 v2
movq      mm4, [Uarray+8+ebx]    ; mm4= u3 u4
movq      mm5, [Varray+8+ebx]    ; mm5= v3 v4
movq      mm6, mm4               ; mm6= u3 u4
punpckhdq mm4, mm5              ; mm4= u3 v3
punpckldq mm6, mm5              ; mm6= u4 v4
movq      [Coords+16+edx], mm4   ; store u3 v3
movq      [Coords+24+edx], mm6   ; store u4 v4

```

Horizontal ADD

Although vertical computations use the SIMD performance better than horizontal computations do, in some cases, the code must use a horizontal operation. The `movlhps/movhlps` and `shuffle` can be used to sum data horizontally. For example, starting with four 128-bit registers, to sum up each register horizontally while having the final results in one register, use the `movlhps/movhlps` instructions to align the upper and lower parts of each register. This allows you to use a vertical add. With the resulting partial horizontal summation, full summation follows

easily. Figure 5-2 schematically presents horizontal add using movhlps/movhlps, while Example 5-9 and Example 5-10 provide the code for this operation.

Figure 5-2 Horizontal Add Using movhlps/movhlps

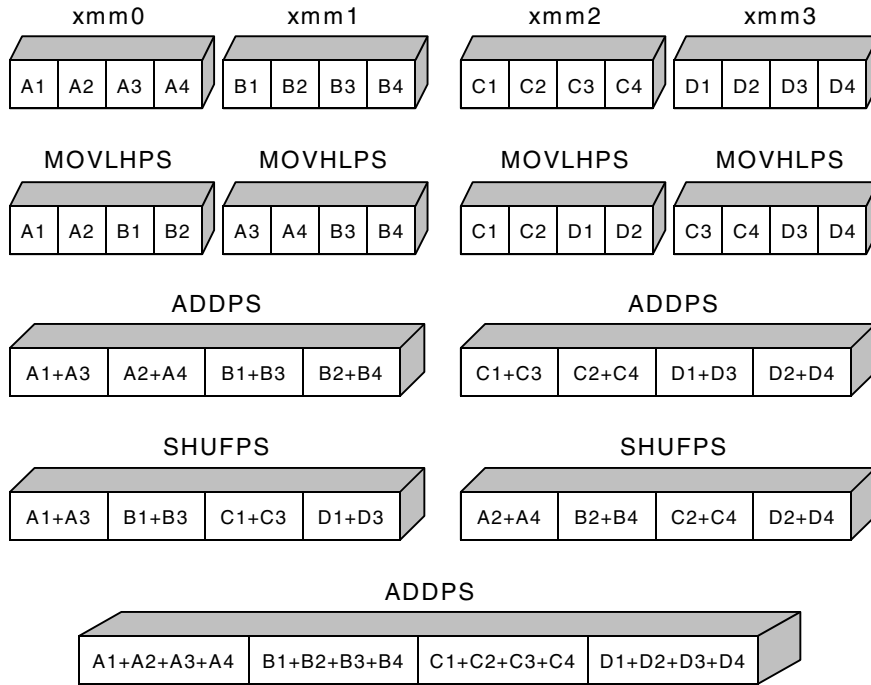

OM15169

Example 5-9 Horizontal Add Using movhlps/movlhps

```

void horiz_add(Vertex_soa *in, float *out) {
    __asm {
        mov     ecx, in           // load structure addresses
        mov     edx, out
        movaps  xmm0, [ecx]      // load A1 A2 A3 A4 => xmm0
        movaps  xmm1, [ecx+16]   // load B1 B2 B3 B4 => xmm1
        movaps  xmm2, [ecx+32]   // load C1 C2 C3 C4 => xmm2
        movaps  xmm3, [ecx+48]   // load D1 D2 D3 D4 => xmm3

        // START HORIZONTAL ADD
        movaps  xmm5, xmm0       // xmm5= A1,A2,A3,A4
        movlhps xmm5, xmm1       // xmm5= A1,A2,B1,B2
        movhlps xmm1, xmm0       // xmm1= A3,A4,B3,B4
        addps   xmm5, xmm1       // xmm5= A1+A3,A2+A4,B1+B3,B2+B4
        movaps  xmm4, xmm2
        movlhps xmm2, xmm3       // xmm2= C1,C2,D1,D2
        movhlps xmm3, xmm4       // xmm3= C3,C4,D3,D4
        addps   xmm3, xmm2       // xmm3= C1+C3,C2+C4,D1+D3,D2+D4
        movaps  xmm6, xmm3       // xmm6= C1+C3,C2+C4,D1+D3,D2+D4
        shufps  xmm3, xmm5, 0xDD //xmm6=A1+A3,B1+B3,C1+C3,D1+D3

        shufps  xmm5, xmm6, 0x88 // xmm5= A2+A4,B2+B4,C2+C4,D2+D4

        addps   xmm6, xmm5       // xmm6= D,C,B,A
    // END HORIZONTAL ADD
        movaps  [edx], xmm6
    }
}

```

Example 5-10 Horizontal Add Using Intrinsics with movhps/movlhps

```

void horiz_add_intrin(Vertex_soa *in, float *out)
{
    __m128 v1, v2, v3, v4;
    __m128 tmm0, tmm1, tmm2, tmm3, tmm4, tmm5, tmm6;
                                     // Temporary variables
    tmm0 = _mm_load_ps(in->x);        // tmm0 = A1 A2 A3 A4
tmm1 = _mm_load_ps(in->y);           // tmm1 = B1 B2 B3 B4
    tmm2 = _mm_load_ps(in->z);        // tmm2 = C1 C2 C3 C4
    tmm3 = _mm_load_ps(in->w);        // tmm3 = D1 D2 D3 D4
    tmm5 = tmm0;                     // tmm0 = A1 A2 A3 A4
    tmm5 = _mm_movehl_ps(tmm5, tmm1); // tmm5 = A1 A2 B1 B2
    tmm1 = _mm_movehl_ps(tmm1, tmm0); // tmm1 = A3 A4 B3 B4
    tmm5 = _mm_add_ps(tmm5, tmm1);    // tmm5 = A1+A3 A2+A4 B1+B3 B2+B4
    tmm4 = tmm2;
    tmm2 = _mm_movehl_ps(tmm2, tmm3); // tmm2 = C1 C2 D1 D2
    tmm3 = _mm_movehl_ps(tmm3, tmm4); // tmm3 = C3 C4 D3 D4
    tmm3 = _mm_add_ps(tmm3, tmm2);    // tmm3 = C1+C3 C2+C4 D1+D3 D2+D4
    tmm6 = tmm3;
    tmm6 = _mm_shuffle_ps(tmm3, tmm5, 0xDD); // tmm6 = A1+A3 B1+B3 C1+C3 D1+D3
    tmm5 = _mm_shuffle_ps(tmm5, tmm6, 0x88); // tmm5 = A2+A4 B2+B4 C2+C4 D2+D4
    tmm6 = _mm_add_ps(tmm6, tmm5);    // tmm6 = A1+A2+A3+A4 B1+B2+B3+B4
                                     // C1+C2+C3+C4 D1+D2+D3+D4
    _mm_store_ps(out, tmm6);
}

```

Use of `cvttps2pi/cvttss2si` Instructions

The `cvttps2pi` and `cvttss2si` instructions encode the truncate/chop rounding mode implicitly in the instruction, thereby taking precedence over the rounding mode specified in the `MXCSR` register. This behavior can eliminate the need to change the rounding mode from round-nearest, to truncate/chop, and then back to round-nearest to resume computation. Frequent changes to the `MXCSR` register should be avoided since there is a penalty associated with writing this register; typically, through the use of the `cvttps2pi` and `cvttss2si` instructions, the rounding control in `MXCSR` can always be set to round-nearest.

Flush-to-Zero Mode

Activating the flush-to-zero mode has the following effects during underflow situations:

- Precision and underflow exception flags are set to 1
- Zero result is returned

The IEEE mandated response to underflow is to deliver the denormalized result (that is, gradual underflow); consequently, the flush-to-zero mode is not compatible with IEEE Standard 754. It is provided to improve performance for applications where underflow is common and where the generation of a denormalized result is not necessary. Underflow for flush-to-zero mode occurs when the exponent for a computed result falls in the denormal range, regardless of whether a loss of accuracy has occurred.

Unmasking the underflow exception takes precedence over flush-to-zero mode. For a SSE instruction that generates an underflow condition an exception handler is invoked.

Optimizing Cache Usage

Over the past decade, processor speed has increased more than ten times. Memory access speed has increased at a slower pace. The resulting disparity has made it important to tune applications so that a majority of the data accesses are fulfilled in the processor caches. The performance of most applications can be considerably improved if the data they require can be fetched from the processor caches rather than from main memory.

Standard techniques to bring data into the processor before it is needed involves additional programming which can be difficult to implement and may require special steps to prevent performance degradation. The Streaming SIMD Extensions addressed these issues by providing the various prefetch instructions. The Intel Pentium 4 and Pentium M processors extend prefetching support via an automatic hardware data prefetch, a new mechanism for data prefetching based on current data access patterns that does not require programmer intervention.

Streaming SIMD Extensions also introduced the various non-temporal store instructions. Streaming SIMD Extensions 2 extend this support to the new data types, and also introduces non-temporal store support for the 32-bit integer registers.

This chapter focuses on two major subjects:

- Prefetch and Cacheability Instructions: discussion about the instructions that allow you to affect data caching in an application.
- Memory Optimization Using Prefetch and Cacheability Instructions: discussion and examples of various techniques for implementing memory optimizations using these instructions.



NOTE. *In a number of cases presented in this chapter, the prefetching and cache utilization are Pentium 4 processor platform-specific and may change for the future processors.*

General Prefetch Coding Guidelines

The following guidelines will help you optimize the usage of prefetches in your code (specific details will be discussed in subsequent sections):

- Take advantage of the hardware prefetcher's ability to prefetch data that are accessed in linear patterns, either forward or backward direction.
- Use a current-generation compiler, such as the Intel C++ Compiler that supports C++ language-level features for the Streaming SIMD Extensions. The Streaming SIMD Extensions and MMX technology instructions provide intrinsics that allow you to optimize cache utilization. The examples of such Intel compiler intrinsics are `_mm_prefetch`, `_mm_stream` and `_mm_load`, `_mm_sfence`. For more details on these intrinsics, refer to the *Intel C++ Compiler User's Guide*, doc. number 718195.
- Facilitate compiler optimization:
 - Minimize use of global variables and pointers.
 - Minimize use of complex control flow.
 - Use the `const` modifier, avoid `register` modifier.
 - Choose data types carefully (see below) and avoid type casting.
- Optimize prefetch scheduling distance –
 - Far ahead enough to allow interim computation to overlap memory access time.
 - Near enough that the prefetched data is not replaced from the data cache.

- Use prefetch concatenation:
 - Arrange prefetches to avoid unnecessary prefetches at the end of an inner loop and to prefetch the first few iterations of the inner loop inside the next outer loop.
- Minimize the number of prefetches:
 - Prefetch instructions are not completely free in terms of bus cycles, machine cycles and resources. Excessive usage of prefetches can adversely impact application performance.
- Interleave prefetch with computation instructions:
 - For best performance, prefetch instructions must be interspersed with other computational instructions in the instruction sequence rather than clustered together.
- Use cache blocking techniques (for example, strip mining):
 - Improve cache hit rate by using cache blocking techniques such as strip-mining (one dimensional arrays) or loop blocking (two dimensional arrays)
- Balance single-pass versus multi-pass execution:
 - An algorithm can use single- or multi-pass execution defined as follows: single-pass, or unlayered execution passes a single data element through an entire computation pipeline. Multi-pass, or layered execution performs a single stage of the pipeline on a batch of data elements before passing the entire batch on to the next stage.
 - General guideline: if your algorithm is single pass, use `prefetchnta`; if your algorithm is multi-pass use `prefetcht0`.
- Resolve memory bank conflict issues:
 - Minimize memory bank conflicts by applying array grouping to group contiguously used data together or allocating data within 4 KB memory pages.

- Resolve cache management issues:
 - Minimize disturbance of temporal data held within the processor's caches by using streaming store instructions, as appropriate

Hardware Data Prefetch

The Pentium 4, Intel Xeon, and Pentium M processors implement an automatic data prefetcher which monitors application data access patterns and prefetches data automatically. This behavior is automatic and does not require programmer's intervention.

Characteristics of the hardware data prefetcher for the Pentium 4 and Intel Xeon processors are:

- Attempts to stay 256 bytes ahead of current data access locations
- Follows only one stream per 4K page (load or store)
- Can prefetch up to 8 simultaneous independent streams from eight different 4K regions
- Does not prefetch across 4K boundary; note that this is independent of paging modes
- Fetches data into second/third-level cache
- Does not prefetch UC or WC memory types
- Follows load and store streams. Issues Read For Ownership (RFO) transactions for store streams and Data Reads for load streams.

The hardware prefetcher implemented in the Pentium M processor fetches data to the second level cache. It can track 12 independent streams in the forward direction and 4 independent streams in the backward direction.

Prefetch and Cacheability Instructions

The prefetch instruction, inserted by the programmers or compilers, accesses a minimum of two cache line of data on the Pentium 4 processor (one cache line of data on the Pentium M processor) prior to that data actually being needed. This hides the latency for data access in the time required to process data already resident in the cache. Many algorithms can provide information in advance about the data that is to be required soon. In cases where the memory accesses are in long, regular data patterns, the automatic hardware prefetcher should be favored over software prefetches.

The cacheability control instructions allow you to control data caching strategy in order to increase cache efficiency and minimize cache pollution.

Data reference patterns can be classified as follows:

Temporal	data will be used again soon
Spatial	data will be used in adjacent locations, for example, same cache line
Non-temporal	data which is referenced once and not reused in the immediate future; for example, some multimedia data types, such as the vertex buffer in a 3D graphics application.

These data characteristics are used in the discussions that follow.

Prefetch

This section discusses the mechanics of the software prefetch instructions and the automatic hardware prefetcher.

Software Data Prefetch

The `prefetch` instruction can hide the latency of data access in performance-critical sections of application code by allowing data to be fetched in advance of its actual usage. The `prefetch` instructions do not change the user-visible semantics of a program, although they may affect the program's performance. The `prefetch` instructions merely provide a hint to the hardware and generally will not generate exceptions or faults.

The `prefetch` instructions load either non-temporal data or temporal data in the specified cache level. This data access type and the cache level are specified as a hint. Depending on the implementation, the instruction fetches 32 or more aligned bytes, including the specified address byte, into the instruction-specified cache levels.

The `prefetch` instruction is implementation-specific; applications need to be tuned to each implementation to maximize performance.



NOTE. *Using the `prefetch` instructions is recommended only if data does not fit in cache.*

The `prefetch` instructions merely provide a hint to the hardware, and they will not generate exceptions or faults except for a few special cases (see the “Prefetch and Load Instructions” section). However, excessive use of prefetch instructions may waste memory bandwidth and result in performance penalty due to resource constraints.

Nevertheless, the prefetch instructions can lessen the overhead of memory transactions by preventing cache pollution and by using the caches and memory efficiently. This is particularly important for applications that share critical system resources, such as the memory bus. See an example in the “Video Encoder” section.

The `prefetch` instructions are mainly designed to improve application performance by hiding memory latency in the background. If segments of an application access data in a predictable manner, for example, using arrays with known strides, then they are good candidates for using `prefetch` to improve performance.

Use the `prefetch` instructions in:

- predictable memory access patterns
- time-consuming innermost loops
- locations where the execution pipeline may stall if data is not available

The Prefetch Instructions – Pentium 4 Processor Implementation

Streaming SIMD Extensions include four flavors of `prefetch` instructions, one non-temporal, and three temporal. They correspond to two types of operations, temporal and non-temporal.



NOTE. *At the time of `prefetch`, if the data is already found in a cache level that is closer to the processor than the cache level specified by the instruction, no data movement occurs.*

The non-temporal instruction is

`prefetchnta` Fetch the data into the second-level cache, minimizing cache pollution.

The temporal instructions are

`prefetcht0` Fetch the data into all cache levels, that is, to the second-level cache for the Pentium 4 processor.

`prefetcht1` Identical to `prefetcht0`

`prefetcht2` Identical to `prefetcht0`

Table 6-1 lists the prefetch implementation differences between the Pentium III and Pentium 4 processors.

Table 6-1 Prefetch Implementation: Pentium III and Pentium 4 Processors

Prefetch Type	Pentium III processor	Pentium 4 processor
Prefetch NTA	Fetch 32 bytes Fetch into 1st- level cache Do not fetch into 2nd-level cache	Fetch 128 bytes Do not fetch into 1st-level cache Fetch into 1 way of 2nd-level cache
PrefetchT0	Fetch 32 bytes Fetch into 1st- level cache Fetch into 2nd- level cache	Fetch 128 bytes Do not fetch into 1st-level cache Fetch into 2nd- level cache
PrefetchT1, PrefetchT2	Fetch 32 bytes Fetch into 2nd- level cache only Do not fetch into 1st-level cache	Fetch 128 bytes Do not fetch into 1st-level cache Fetch into 2nd- level cache only

Prefetch and Load Instructions

The Pentium 4 processor has a decoupled execution and memory architecture that allows instructions to be executed independently with memory accesses if there are no data and resource dependencies. Programs or compilers can use dummy load instructions to imitate prefetch functionality, but preloading is not completely equivalent to prefetch instructions. Prefetch instructions provide a greater performance than preloading.

Currently, the `prefetch` instruction provides a greater performance gain than preloading because it:

- has no destination register, it only updates cache lines.
- does not stall the normal instruction retirement.
- does not affect the functional behavior of the program.

- has no cache line split accesses.
- does not cause exceptions except when `LOCK` prefix is used; the `LOCK` prefix is not a valid prefix for use with the `prefetch` instructions and should not be used.
- does not complete its own execution if that would cause a fault.

The current advantages of the `prefetch` over preloading instructions are processor-specific. The nature and extent of the advantages may change in the future.

In addition there are a few cases where a `prefetch` instruction will not perform the data prefetch if:

- the `prefetch` causes a DTLB (Data Translation Lookaside Buffer) miss.
- an access to the specified address causes a fault/exception.
- the memory subsystem runs out of request buffers between the first-level cache and the second-level cache.
- the `prefetch` targets an uncacheable memory region, for example, USWC and UC.
- a `LOCK` prefix is used. This causes an invalid opcode exception.

Cacheability Control

This section covers the mechanics of the cacheability control instructions.

The Non-temporal Store Instructions

This section describes the behavior of streaming stores and reiterates some of the information presented in the previous section. In Streaming SIMD Extensions, the `movntps`, `movntpd`, `movntq`, `movntdq`, `movnti`, `maskmovq` and `maskmovdqu` instructions are streaming, non-temporal stores. With regard to memory characteristics and ordering, they are similar mostly to the Write-Combining (`wc`) memory type:

- Write combining – successive writes to the same cache line are combined
- Write collapsing – successive writes to the same byte(s) result in only the last write being visible
- Weakly ordered – no ordering is preserved between `wc` stores, or between `wc` stores and other loads or stores
- Uncacheable and not write-allocating – stored data is written around the cache and will not generate a read-for-ownership bus request for the corresponding cache line

Fencing

Because streaming stores are weakly ordered, a fencing operation is required to ensure that the stored data is flushed from the processor to memory. Failure to use an appropriate fence may result in data being “trapped” within the processor and will prevent visibility of this data by other processors or system agents. `WC` stores require software to ensure coherence of data by performing the fencing operation; see “The fence Instructions” section for more information.

Streaming Non-temporal Stores

Streaming stores can improve performance in the following ways:

- Increase store bandwidth if 64 bytes that fit within a cache line are written consecutively, since they do not require read-for-ownership bus requests and 64 bytes are combined into a single bus write transaction.
- Reduce disturbance of frequently used cached (temporal) data, since they write around the processor caches.

Streaming stores allow cross-aliasing of memory types for a given memory region. For instance, a region may be mapped as write-back (`WB`) via the page attribute tables (`PAT`) or memory type range registers (`MTRRS`) and yet is written using a streaming store.

Memory Type and Non-temporal Stores

The memory type can take precedence over the non-temporal hint, leading to the following considerations:

- If the programmer specifies a non-temporal store to strongly-ordered uncacheable memory, for example, the Uncacheable (UC) or Write-Protect (WP) memory types, then the store behaves like an uncacheable store; the non-temporal hint is ignored and the memory type for the region is retained.
- If the programmer specifies the weakly-ordered uncacheable memory type of Write-Combining (WC), then the non-temporal store and the region have the same semantics, and there is no conflict.
- If the programmer specifies a non-temporal store to cacheable memory, for example, Write-Back (WB) or Write-Through (WT) memory types, two cases may result:
 1. If the data is present in the cache hierarchy, the instruction will ensure consistency. A particular processor may choose different ways to implement this. The following approaches are probable:
 - (a) updating data in-place in the cache hierarchy while preserving the memory type semantics assigned to that region,
 - or (b) evicting the data from the caches and writing the new non-temporal data to memory (with WC semantics). Pentium III processor implements a combination of both approaches.

If the streaming store hits a line that is present in the first-level cache, the store data will be combined in place within the first-level cache. If the streaming store hits a line present in the second-level, the line and stored data will be flushed from the second-level to system memory. Note that the approaches, separate or combined, can be different for future processors. Pentium 4 processor implements the latter policy, of evicting the data from all processor caches.

2. If the data is not present in the cache hierarchy, and the destination region is mapped as `WB` or `WT`, the transaction will be weakly ordered, and is subject to all `wc` memory semantics. The non-temporal store will not write-allocate. Different implementations may choose to collapse and combine these stores.

Write-Combining

Generally, `wc` semantics require software to ensure coherence, with respect to other processors and other system agents (such as graphics cards). Appropriate use of synchronization and a fencing operation (see “The fence Instructions” later in this chapter) must be performed for producer-consumer usage models. Fencing ensures that all system agents have global visibility of the stored data; for instance, failure to fence may result in a written cache line staying within a processor, and the line would not be visible to other agents.

For processors which implement non-temporal stores by updating data in-place that already resides in the cache hierarchy, the destination region should also be mapped as `wc`. Otherwise if mapped as `WB` or `WT`, there is a potential for speculative processor reads to bring the data into the caches; in this case, non-temporal stores would then update in place, and data would not be flushed from the processor by a subsequent fencing operation.

The memory type visible on the bus in the presence of memory type aliasing is implementation-specific. As one possible example, the memory type written to the bus may reflect the memory type for the first store to this line, as seen in program order; other alternatives are possible. This behavior should be considered reserved, and dependence on the behavior of any particular implementation risks future incompatibility.

Streaming Store Usage Models

The two primary usage domains for streaming store are coherent requests and non-coherent requests.

Coherent Requests

Coherent requests are normal loads and stores to system memory, which may also hit cache lines present in another processor in a multi-processor environment. With coherent requests, a streaming store can be used in the same way as a regular store that has been mapped with a `WC` memory type (`PAT` or `MTRR`). An `sfence` instruction must be used within a producer-consumer usage model in order to ensure coherency and visibility of data between processors.

Within a single-processor system, the CPU can also re-read the same memory location and be assured of coherence (that is, a single, consistent view of this memory location): the same is true for a multi-processor (MP) system, assuming an accepted MP software producer-consumer synchronization policy is employed.

Non-coherent requests

Non-coherent requests arise from an I/O device, such as an AGP graphics card, that reads or writes system memory using non-coherent requests, which are not reflected on the processor bus and thus will not query the processor's caches. An `sfence` instruction must be used within a producer-consumer usage model in order to ensure coherency and visibility of data between processors. In this case, if the processor is writing data to the I/O device, a streaming store can be used with a processor with any behavior of approach (a), page 6-11, above, only if the region has also been mapped with a `WC` memory type (`PAT`, `MTRR`).



CAUTION. *Failure to map the region as `WC` may allow the line to be speculatively read into the processor caches, that is, via the wrong path of a mispredicted branch.*

In case the region is not mapped as `WC`, the streaming might update in-place in the cache and a subsequent `sfence` would not result in the data being written to system memory. Explicitly mapping the region as `WC` in this case ensures that any data read from this region will not be placed in the processor's caches. A read of this memory location by a non-coherent I/O device would return incorrect/out-of-date results. For a processor which solely implements approach (b), page 6-11, above, a streaming store can be used in this non-coherent domain without requiring the memory region to also be mapped as `WB`, since any cached data will be flushed to memory by the streaming store.

Streaming Store Instruction Descriptions

The `movntq/movntdq` (non-temporal store of packed integer in an MMX technology or Streaming SIMD Extensions register) instructions store data from a register to memory. The instruction is implicitly weakly-ordered, does no write-allocate, and so minimizes cache pollution.

The `movntps` (non-temporal store of packed single precision floating point) instruction is similar to `movntq`. It stores data from a Streaming SIMD Extensions register to memory in 16-byte granularity. Unlike `movntq`, the memory address must be aligned to a 16-byte boundary or a general protection exception will occur. The instruction is implicitly weakly-ordered, does not write-allocate, and thus minimizes cache pollution.

The `maskmovq/maskmovdqu` (non-temporal byte mask store of packed integer in an MMX technology or Streaming SIMD Extensions register) instructions store data from a register to the location specified by the `edi` register. The most significant bit in each byte of the second mask register is used to selectively write the data of the first register on a per-byte basis. The instruction is implicitly weakly-ordered (that is, successive stores may not write memory in original program-order), does not write-allocate, and thus minimizes cache pollution.

The `fence` Instructions

The following fence instructions are available: `sfence`, `lfence`, and `mfence`.

The `sfence` Instruction

The `sfence` (store fence) instruction makes it possible for every `store` instruction that precedes the `sfence` instruction in program order to be globally visible before any `store` instruction that follows the `sfence`. The `sfence` instruction provides an efficient way of ensuring ordering between routines that produce weakly-ordered results.

The use of weakly-ordered memory types can be important under certain data sharing relationships, such as a producer-consumer relationship. Using weakly-ordered memory can make assembling the data more efficient, but care must be taken to ensure that the consumer obtains the data that the producer intended to see. Some common usage models may be affected in this way by weakly-ordered stores. Examples are:

- library functions, which use weakly-ordered memory to write results
- compiler-generated code, which also benefits from writing weakly-ordered results
- hand-crafted code

The degree to which a consumer of data knows that the data is weakly-ordered can vary for these cases. As a result, the `sfence` instruction should be used to ensure ordering between routines that produce weakly-ordered data and routines that consume this data. The `sfence` instruction provides a performance-efficient way by ensuring the ordering when every `store` instruction that precedes the `store fence` instruction in program order is globally visible before any `store` instruction which follows the `fence`.

The `lfence` Instruction

The `lfence` (load fence) instruction makes it possible for every `load` instruction that precedes the `lfence` instruction in program order to be globally visible before any `load` instruction that follows the `lfence`. The `lfence` instruction provides a means of segregating certain load instructions from other loads.

The `mfence` Instruction

The `mfence` (memory fence) instruction makes it possible for every `load` and `store` instruction that precedes the `mfence` instruction in program order to be globally visible before any other `load` or `store` instruction that follows the `mfence`. The `mfence` instruction provides a means of segregating certain memory instructions from other memory references.

Note that the use of a `lfence` and `sfence` is not equivalent to the use of a `mfence` since the load and store fences are not ordered with respect to each other. In other words, the load fence can be executed before prior stores, and the store fence can be executed before prior loads. The `mfence` instruction should be used whenever the cache line flush instruction (`clflush`) is used to ensure that speculative memory references generated by the processor do not interfere with the flush; see “The `clflush` Instruction” for more information.

The `clflush` Instruction

The cache line associated with the linear address specified by the value of byte address is invalidated from all levels of the processor cache hierarchy (data and instruction). The invalidation is broadcast throughout the coherence domain. If, at any level of the cache hierarchy, the line is inconsistent with memory (dirty) it is written to memory before invalidation. Other characteristics include:

- The data size affected is the cache coherency size, which is 64 bytes on Pentium 4 processor.
- The memory attribute of the page containing the affected line has no effect on the behavior of this instruction.
- The `clflush` instruction can be used at all privilege levels and is subject to all permission checking and faults associated with a byte load.

`clflush` is an unordered operation with respect to other memory traffic including other `clflush` instructions. Software should use a `mfence`, memory fence for cases where ordering is a concern.

As an example, consider a video usage model, wherein a video capture device is using non-coherent AGP accesses to write a capture stream directly to system memory. Since these non-coherent writes are not broadcast on the processor bus, they will not flush any copies of the same locations that reside in the processor caches. As a result, before the processor re-reads the capture buffer, it should use `clflush` to ensure that any stale copies of the capture buffer are flushed from the processor caches. Due to speculative reads that may be generated by the processor, it is important to observe appropriate fencing, using `mfence`.

Example 6-1 illustrates the pseudo-code for the recommended usage of `clflush`.

Example 6-1 Pseudo-code for Using cflush

```
while (!buffer_ready) {}  
mfence  
    for(i=0;i<num_cachelines;i+=cacheline_size) {  
        cflush (char *)((unsigned int)buffer + i)  
    }  
mfence  
    prefnta buffer[0];  
    VAR = buffer[0];
```

Memory Optimization Using Prefetch

The Pentium 4 processor has two mechanisms for data prefetch: software-controlled prefetch and an automatic hardware prefetch.

Software-controlled Prefetch

The software-controlled prefetch is enabled using the four prefetch instructions introduced with Streaming SIMD Extensions instructions. These instructions are hints to bring a cache line of data in to various levels and modes in the cache hierarchy. The software-controlled prefetch is not intended for prefetching code. Using it can incur significant penalties on a multiprocessor system when code is shared.

Software prefetching has the following characteristics:

- Can handle irregular access patterns, which do not trigger the hardware prefetcher.
- Can use less bus bandwidth than hardware prefetching; see below.
- Software prefetches must be added to new code, and do not benefit existing applications.

Hardware Prefetch

The automatic hardware prefetch, can bring lines into the unified first-level cache based on prior data misses. The automatic hardware prefetcher will attempt to prefetch two cache lines ahead of the prefetch stream. This feature is introduced with the Pentium 4 processor.

There are different strengths and weaknesses to software and hardware prefetching of the Pentium 4 processor. The characteristics of the hardware prefetching are as follows (compare with the software prefetching features listed above):

- Works with existing applications.
- Requires regular access patterns.
- Start-up penalty before hardware prefetcher triggers and extra fetches after array finishes. For short arrays this overhead can reduce effectiveness of the hardware prefetcher.
 - The hardware prefetcher requires a couple misses before it starts operating.
 - Hardware prefetching will generate a request for data beyond the end of an array, which will not be utilized. This behavior wastes bus bandwidth. In addition this behavior results in a start-up penalty when fetching the beginning of the next array; this occurs because the wasted prefetch should have been used instead to hide the latency for the initial data in the next array. Software prefetching can recognize and handle these cases.
- Will not prefetch across a 4K page boundary; i.e., the program would have to initiate demand loads for the new page before the hardware prefetcher will start prefetching from the new page.

Example of Latency Hiding with S/W Prefetch Instruction

Achieving the highest level of memory optimization using prefetch instructions requires an understanding of the microarchitecture and system architecture of a given machine. This section translates the key architectural implications into several simple guidelines for programmers to use.

Figure 6-1 and Figure 6-2 show two scenarios of a simplified 3D geometry pipeline as an example. A 3D-geometry pipeline typically fetches one vertex record at a time and then performs transformation and lighting functions on it. Both figures show two separate pipelines, an execution pipeline, and a memory pipeline (front-side bus).

Since the Pentium 4 processor, similarly to the Pentium II and Pentium III processors, completely decouples the functionality of execution and memory access, these two pipelines can function concurrently. Figure 6-1 shows “bubbles” in both the execution and memory pipelines. When loads are issued for accessing vertex data, the execution units sit idle and wait until data is returned. On the other hand, the memory bus sits idle while the execution units are processing vertices. This scenario severely decreases the advantage of having a decoupled architecture.

Figure 6-1 Memory Access Latency and Execution Without Prefetch

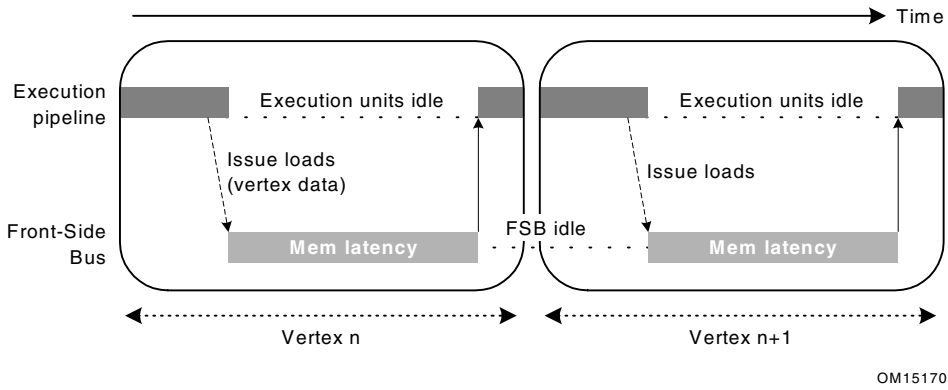
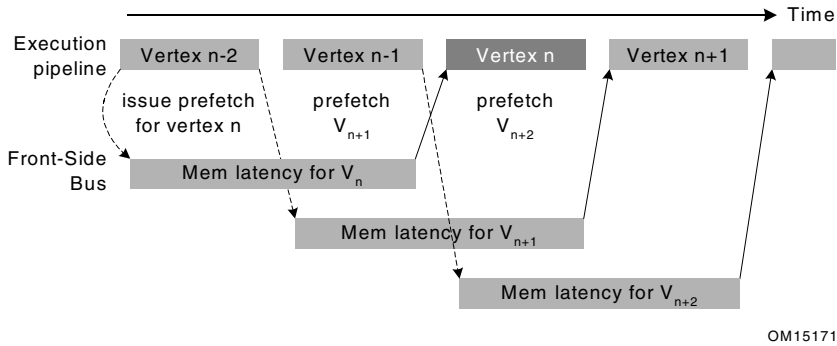

Figure 6-2 Memory Access Latency and Execution With Prefetch



The performance loss caused by poor utilization of resources can be completely eliminated by correctly scheduling the prefetch instructions appropriately. As shown in Figure 6-2, prefetch instructions are issued

two vertex iterations ahead. This assumes that only one vertex gets processed in one iteration and a new data cache line is needed for each iteration. As a result, when iteration n , vertex V_n , is being processed, the requested data is already brought into cache. In the meantime, the front-side bus is transferring the data needed for iteration $n+1$, vertex V_{n+1} . Because there is no dependence between V_{n+1} data and the execution of V_n , the latency for data access of V_{n+1} can be entirely hidden behind the execution of V_n . Under such circumstances, no “bubbles” are present in the pipelines and thus the best possible performance can be achieved.

Prefetching is useful for inner loops that have heavy computations, or are close to the boundary between being compute-bound and memory-bandwidth-bound.

The prefetch is probably not very useful for loops which are predominately memory bandwidth-bound.

When data is already located in the first level cache, prefetching can be useless and could even slow down the performance because the extra μ ops either back up waiting for outstanding memory accesses or may be dropped altogether. This behavior is platform-specific and may change in the future.

Prefetching Usage Checklist

The following checklist covers issues that need to be addressed and/or resolved to use the prefetch instruction properly:

- Determine prefetch scheduling distance
- Use prefetch concatenation
- Minimize the number of prefetches
- Mix prefetch with computation instructions
- Use cache blocking techniques (for example, strip mining)
- Balance single-pass versus multi-pass execution

- Resolve memory bank conflict issues
- Resolve cache management issues

The subsequent sections discuss all the above items.

Prefetch Scheduling Distance

Determining the ideal prefetch placement in the code depends on many architectural parameters, including the amount of memory to be prefetched, cache lookup latency, system memory latency, and estimate of computation cycle. The ideal distance for prefetching data is processor- and platform-dependent. If the distance is too short, the prefetch will not hide any portion of the latency of the fetch behind computation. If the prefetch is too far ahead, the prefetched data may be flushed out of the cache by the time it is actually required.

Since prefetch distance is not a well-defined metric, for this discussion, we define a new term, prefetch scheduling distance (PSD), which is represented by the number of iterations. For large loops, prefetch scheduling distance can be set to 1, that is, schedule prefetch instructions one iteration ahead. For small loop bodies, that is, loop iterations with little computation, the prefetch scheduling distance must be more than one iteration.

A simplified equation to compute PSD is deduced from the mathematical model. For a simplified equation, complete mathematical model, and methodology of prefetch distance determination, refer to Appendix E, “Mathematics of Prefetch Scheduling Distance”.

Example 6-2 illustrates the use of a prefetch within the loop body. The prefetch scheduling distance is set to 3, `esi` is effectively the pointer to a line, `edx` is the address of the data being referenced and `xmm1-xmm4` are the data used in computation. Example 6-3 uses two independent cache

lines of data per iteration. The PSD would need to be increased/decreased if more/less than two cache lines are used per iteration.

Example 6-2 Prefetch Scheduling Distance

```
top_loop:
    prefetchnta [edx + esi + 128*3]
    prefetchnta [edx*4 + esi + 128*3]
    . . . . .
    movaps xmm1, [edx + esi]
    movaps xmm2, [edx*4 + esi]
    movaps xmm3, [edx + esi + 16]
    movaps xmm4, [edx*4 + esi + 16]
    . . . . .
    . . . . .
    add     esi, 128
    cmp    esi, ecx
    jl     top_loop
```

Prefetch Concatenation

Maximum performance can be achieved when execution pipeline is at maximum throughput, without incurring any memory latency penalties. This can be achieved by prefetching data to be used in successive iterations in a loop. De-pipelining memory generates bubbles in the execution pipeline. To explain this performance issue, a 3D geometry pipeline that processes 3D vertices in strip format is used as an example. A strip contains a list of vertices whose predefined vertex order forms contiguous triangles. It can be easily observed that the memory pipe is de-pipelined on the strip boundary due to ineffective prefetch arrangement. The execution pipeline is stalled for the first two iterations for each strip. As a result, the average latency for completing an

iteration will be 165(FIX) clocks. (See Appendix E, “Mathematics of Prefetch Scheduling Distance”, for a detailed memory pipeline description.)

This memory de-pipelining creates inefficiency in both the memory pipeline and execution pipeline. This de-pipelining effect can be removed by applying a technique called prefetch concatenation. With this technique, the memory access and execution can be fully pipelined and fully utilized.

For nested loops, memory de-pipelining could occur during the interval between the last iteration of an inner loop and the next iteration of its associated outer loop. Without paying special attention to prefetch insertion, the loads from the first iteration of an inner loop can miss the cache and stall the execution pipeline waiting for data returned, thus degrading the performance.

In the code of Example 6-3, the cache line containing `a[ii][0]` is not prefetched at all and always misses the cache. This assumes that no array `a[][]` footprint resides in the cache. The penalty of memory de-pipelining stalls can be amortized across the inner loop iterations. However, it may become very harmful when the inner loop is short. In addition, the last prefetch in the last PSD iterations are wasted and consume machine resources. Prefetch concatenation is introduced here in order to eliminate the performance issue of memory de-pipelining.

Example 6-3 Using Prefetch Concatenation

```
for (ii = 0; ii < 100; ii++) {
    for (jj = 0; jj < 32; jj+=8) {
        prefetch a[ii][jj+8]
        computation a[ii][jj]
    }
}
```

Prefetch concatenation can bridge the execution pipeline bubbles between the boundary of an inner loop and its associated outer loop. Simply by unrolling the last iteration out of the inner loop and specifying the effective prefetch address for data used in the following iteration, the performance loss of memory de-pipelining can be completely removed. Example 6-4 gives the rewritten code.

Example 6-4 Concatenation and Unrolling the Last Iteration of Inner Loop

```
for (ii = 0; ii < 100; ii++) {
    for (jj = 0; jj < 24; jj+=8) { /* N-1 iterations */
        prefetch a[ii][jj+8]
        computation a[ii][jj]
    }
    prefetch a[ii+1][0]
    computation a[ii][jj]/* Last iteration */
}
```

This code segment for data prefetching is improved and only the first iteration of the outer loop suffers any memory access latency penalty, assuming the computation time is larger than the memory latency. Inserting a prefetch of the first data element needed prior to entering the nested loop computation would eliminate or reduce the start-up penalty for the very first iteration of the outer loop. This uncomplicated high-level code optimization can improve memory performance significantly.

Minimize Number of Prefetches

Prefetch instructions are not completely free in terms of bus cycles, machine cycles and resources, even though they require minimal clocks and memory bandwidth.

Excessive prefetching may lead to performance penalties because issue penalties in the front-end of the machine and/or resource contention in the memory sub-system. This effect may be severe in cases where the target loops are small and/or cases where the target loop is issue-bound

One approach to solve the excessive prefetching issue is to unroll and/or software-pipeline the loops to reduce the number of prefetches required. Figure 6-3 presents a code example which implements prefetch and unrolls the loop to remove the redundant prefetch instructions whose prefetch addresses hit the previously issued prefetch instructions. In this particular example, unrolling the original loop once saves six prefetch instructions and nine instructions for conditional jumps in every other iteration.

Figure 6-3 Prefetch and Loop Unrolling

<pre> top_loop: prefetchnta [edx+esi+32] prefetchnta [edx*4+esi+32] movaps xmm1, [edx+esi] movaps xmm2, [edx*4+esi] add esi, 16 cmp esi, ecx jl top_loop </pre>	<div style="border-left: 1px solid black; border-right: 1px solid black; border-bottom: 1px solid black; width: 20px; height: 20px; margin: 0 auto;"></div> <p style="text-align: center;">unrolled iteration</p> <div style="border-left: 1px solid black; border-right: 1px solid black; border-bottom: 1px solid black; width: 20px; height: 20px; margin: 0 auto;"></div>	<pre> top_loop: prefetchnta [edx+esi+128] prefetchnta [edx*4+esi+128] movaps xmm1, [edx+esi] movaps xmm2, [edx*4+esi] movaps xmm1, [edx+esi+16] movaps xmm2, [edx*4+esi+16] movaps xmm1, [edx+esi+96] movaps xmm2, [edx*4+esi+96] add esi, 128 cmp esi, ecx jl top_loop </pre>
---	---	--

OM15172

Figure 6-4 demonstrates the effectiveness of software prefetches in latency hiding. The X axis indicates the number of computation clocks per loop (each iteration is independent). The Y axis indicates the execution time measured in clocks per loop. The secondary Y axis indicates the percentage of bus bandwidth utilization. The tests vary by the following parameters:

1. The number of load/store streams. Each load and store stream accesses one 128-byte cache line each, per iteration.
2. The amount of computation per loop. This is varied by increasing the number of dependent arithmetic operations executed.
3. The number of the software prefetches per loop. (for example, one every 16 bytes, 32 bytes, 64 bytes, 128 bytes).

As expected, the leftmost portion of each of the graphs in Figure 6-4 shows that when there is not enough computation to overlap the latency of memory access, prefetch does not help and that the execution is essentially memory-bound. The graphs also illustrate that redundant prefetches do not increase performance.

Figure 6-4 Memory Access Latency and Execution With Prefetch

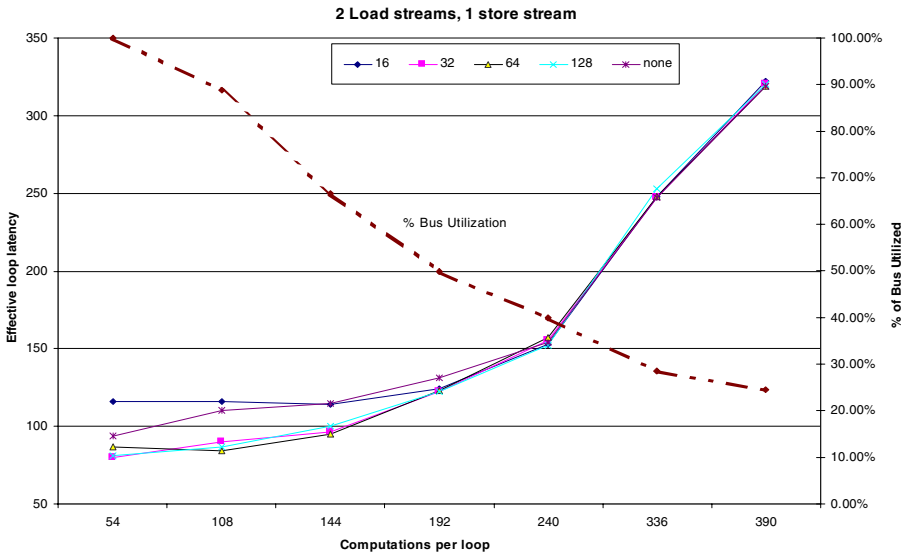
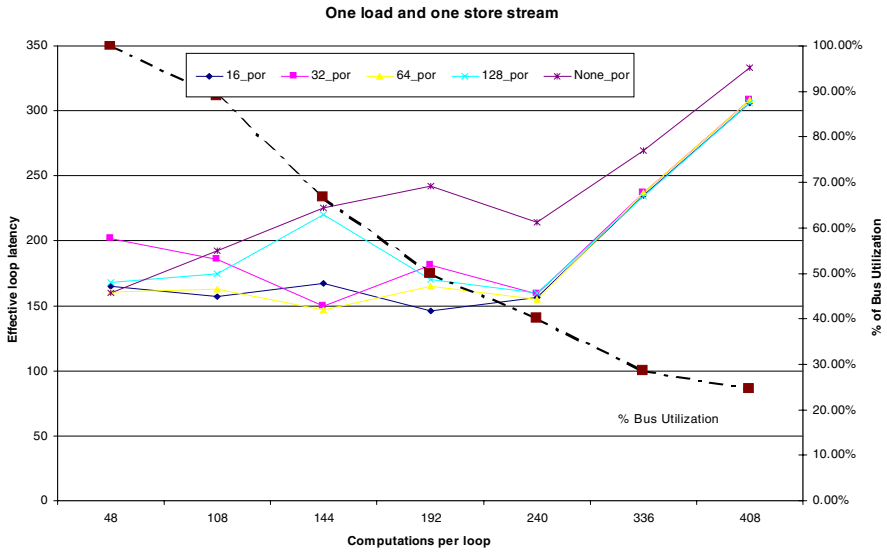

Mix Prefetch with Computation Instructions

It may seem convenient to cluster all of the prefetch instructions at the beginning of a loop body or before a loop, but this can lead to severe performance degradation. In order to achieve best possible performance, prefetch instructions must be interspersed with other computational instructions in the instruction sequence rather than clustered together. If possible, they should also be placed apart from loads. This improves the instruction level parallelism and reduces the potential instruction resource stalls. In addition, this mixing reduces the pressure on the memory access resources and in turn reduces the possibility of the prefetch retiring without fetching data.

Example 6-5 illustrates distributing prefetch instructions. A simple and useful heuristic of prefetch spreading for a Pentium 4 processor is to insert a prefetch instruction every 20 to 25 clocks. Rearranging prefetch instructions could yield a noticeable speedup for the code which stresses the cache resource.

Example 6-5 Spread Prefetch Instructions

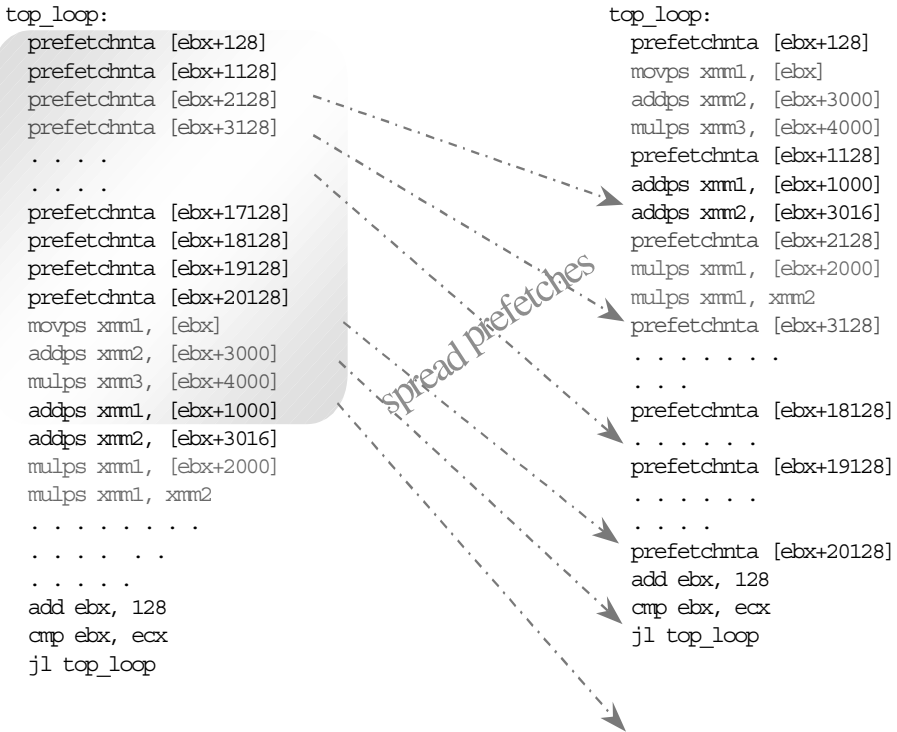

NOTE. To avoid instruction execution stalls due to the over-utilization of the resource, prefetch instructions must be interspersed with computational instructions.

Prefetch and Cache Blocking Techniques

Cache blocking techniques, such as strip-mining, are used to improve temporal locality, and thereby cache hit rate. Strip-mining is a one-dimensional temporal locality optimization for memory. When two-dimensional arrays are used in programs, loop blocking technique (similar to strip-mining but in two dimensions) can be applied for a better memory performance.

If an application uses a large data set that can be reused across multiple passes of a loop, it will benefit from strip mining: data sets larger than the cache will be processed in groups small enough to fit into cache. This allows temporal data to reside in the cache longer, reducing bus traffic.

Data set size and temporal locality (data characteristics) fundamentally affect how prefetch instructions are applied to strip-mined code. Figure 6-5 shows two simplified scenarios for temporally-adjacent data and temporally-non-adjacent data.

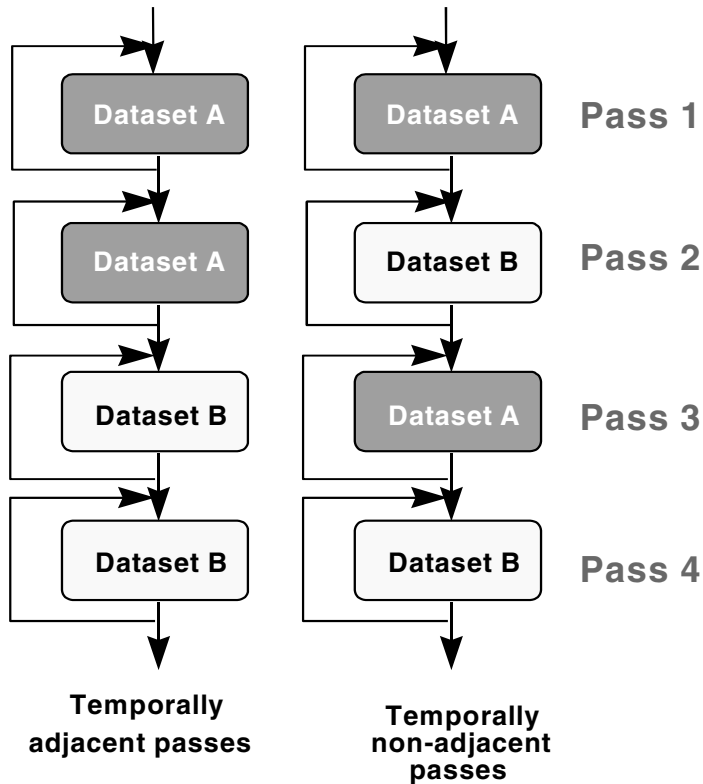
Figure 6-5 Cache Blocking – Temporally Adjacent and Non-adjacent Passes

In the temporally-adjacent scenario, subsequent passes use the same data and find it already in second-level cache. Prefetch issues aside, this is the preferred situation. In the temporally non-adjacent scenario, data used in pass m is displaced by pass $(m+1)$, requiring data *re-fetch* into the first level cache and perhaps the second level cache if a later pass reuses the data. If both data sets fit into the second-level cache, load operations in passes 3 and 4 become less expensive.

Figure 6-6 shows how prefetch instructions and strip-mining can be applied to increase performance in both of these scenarios.

Figure 6-6 Examples of Prefetch and Strip-mining for Temporally Adjacent and Non-Adjacent Passes Loops

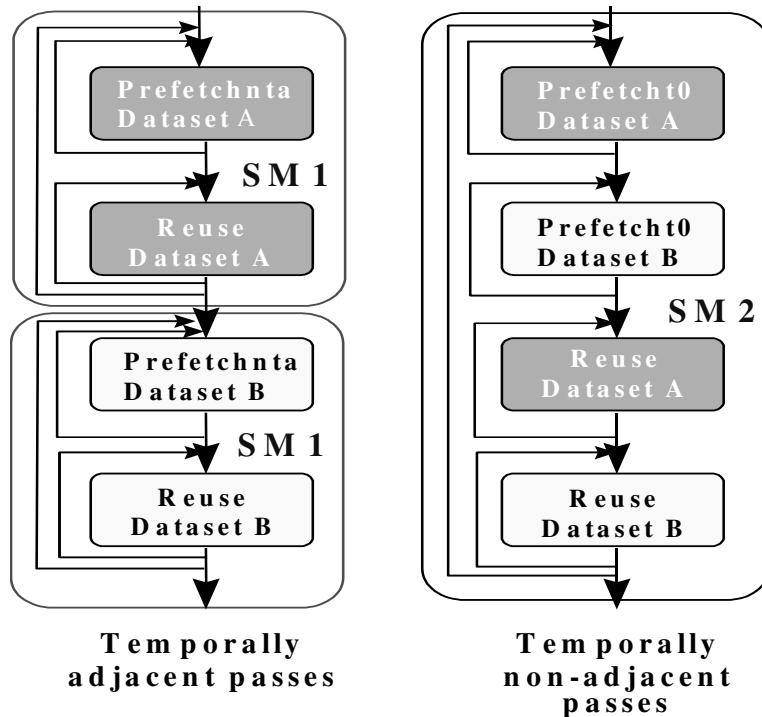

For Pentium 4 processors, the left scenario shows a graphical implementation of using `prefetchnta` to prefetch data into selected ways of the second-level cache *only* (SM1 denotes strip mine one way of second-level), minimizing second-level cache pollution. Use `prefetchnta` if the data is only touched once during the entire execution pass in order to minimize cache pollution in the higher level caches. This provides instant availability, assuming the prefetch was issued far ahead enough, when the read access is issued.

In scenario to the right, in Figure 6-6, keeping the data in one way of the second-level cache does not improve cache locality. Therefore, use `prefetcht0` to prefetch the data. This hides the latency of the memory references in passes 1 and 2, and keeps a copy of the data in second-level cache, which reduces memory traffic and latencies for passes 3 and 4. To further reduce the latency, it might be worth considering extra `prefetchnta` instructions prior to the memory references in passes 3 and 4.

In Example 6-6, consider the data access patterns of a 3D geometry engine first without strip-mining and then incorporating strip-mining. Note that 4-wide SIMD instructions of Pentium III processor can process 4 vertices per every iteration.

Example 6-6 Data Access of a 3D Geometry Engine without Strip-mining

```
while (nvtx < MAX_NUM_VTX) {
    prefetchnta vertexi data // v = [x, y, z, nx, ny, nz, tu, tv]
    prefetchnta vertexi+1 data
    prefetchnta vertexi+2 data
    prefetchnta vertexi+3 data
    TRANSFORMATION code // use only x, y, z, tu, tv of a vertex
    nvtx+=4
}

while (nvtx < MAX_NUM_VTX) {
    prefetchnta vertexi data // v = [x, y, z, nx, ny, nz, tu, tv]
                                // x, y, z fetched again

    prefetchnta vertexi+1 data
    prefetchnta vertexi+2 data
    prefetchnta vertexi+3 data
    compute the light vectors // use only x, y, z
    LOCAL LIGHTING code // use only nx, ny, nz
    nvtx+=4
}
```

Without strip-mining, all the x,y,z coordinates for the four vertices must be re-fetched from memory in the second pass, that is, the lighting loop. This causes under-utilization of cache lines fetched during transformation loop as well as bandwidth wasted in the lighting loop.

Now consider the code in Example 6-7 where strip-mining has been incorporated into the loops.

Example 6-7 Data Access of a 3D Geometry Engine with Strip-mining

```
while (nstrip < NUM_STRIP) {
/* Strip-mine the loop to fit data into one way of the second-level
   cache */
  while (nvtx < MAX_NUM_VTX_PER_STRIP) {
    prefetchnta vertexi data          // v=[x,y,z,nx,ny,nz,tu,tv]
    prefetchnta vertexi+1 data
    prefetchnta vertexi+2 data
    prefetchnta vertexi+3 data
    TRANSFORMATION code
    nvtx+=4
  }
  while (nvtx < MAX_NUM_VTX_PER_STRIP) {
    /* x y z coordinates are in the second-level cache, no prefetch
       is
       required */
    compute the light vectors
    POINT LIGHTING code
    nvtx+=4
  }
}
```

With strip-mining, all the vertex data can be kept in the cache (for example, one way of second-level cache) during the strip-mined transformation loop and reused in the lighting loop. Keeping data in the cache reduces both bus traffic and the number of prefetches used.

Figure 6-7 summarizes the steps of the basic usage model that incorporates prefetch with strip-mining. The steps are:

- Do strip-mining: partition loops so that the dataset fits into second-level cache.
- Use `prefetchnta` if the data is only used once or the dataset fits into 32K (one way of second-level cache). Use `prefetcht0` if the dataset exceeds 32K.

The above steps are platform-specific and provide an implementation example. The variables `NUM_STRIP` and `MAX_NUM_VX_PER_STRIP` can be heuristically determined for peak performance for specific application on a specific platform.

Figure 6-7 Incorporating Prefetch into Strip-mining Code

Use Once	Use Multiple Times	
	Adjacent Passes	Non-Adjacent Passes
Prefetchnta	Prefetch0, SM1	Prefetch0, SM1 (2 nd Level Pollution)

Single-pass versus Multi-pass Execution

An algorithm can use single- or multi-pass execution defined as follows:

- Single-pass, or unlayered execution passes a single data element through an entire computation pipeline.

- Multi-pass, or layered execution performs a single stage of the pipeline on a batch of data elements, before passing the batch on to the next stage.

A characteristic feature of both single-pass and multi-pass execution is that a specific trade-off exists depending on an algorithm's implementation and use of a single-pass or multiple-pass execution, see Figure 6-8.

Multi-pass execution is often easier to use when implementing a general purpose API, where the choice of code paths that can be taken depends on the specific combination of features selected by the application (for example, for 3D graphics, this might include the type of vertex primitives used and the number and type of light sources).

With such a broad range of permutations possible, a single-pass approach would be complicated, in terms of code size and validation. In such cases, each possible permutation would require a separate code sequence. For example, an object with features A, B, C, D can have a subset of features enabled, say, A, B, D. This stage would use one code path; another combination of enabled features would have a different code path. It makes more sense to perform each pipeline stage as a separate pass, with conditional clauses to select different features that are implemented within each stage. By using strip-mining, the number of vertices processed by each stage (for example, the batch size) can be selected to ensure that the batch stays within the processor caches through all passes. An intermediate cached buffer is used to pass the batch of vertices from one stage or pass to the next one.

Single-pass execution can be better suited to applications which limit the number of features that may be used at a given time. A single-pass approach can reduce the amount of data copying that can occur with a multi-pass engine, see Figure 6-8.

Figure 6-8 Single-Pass Vs. Multi-Pass 3D Geometry Engines

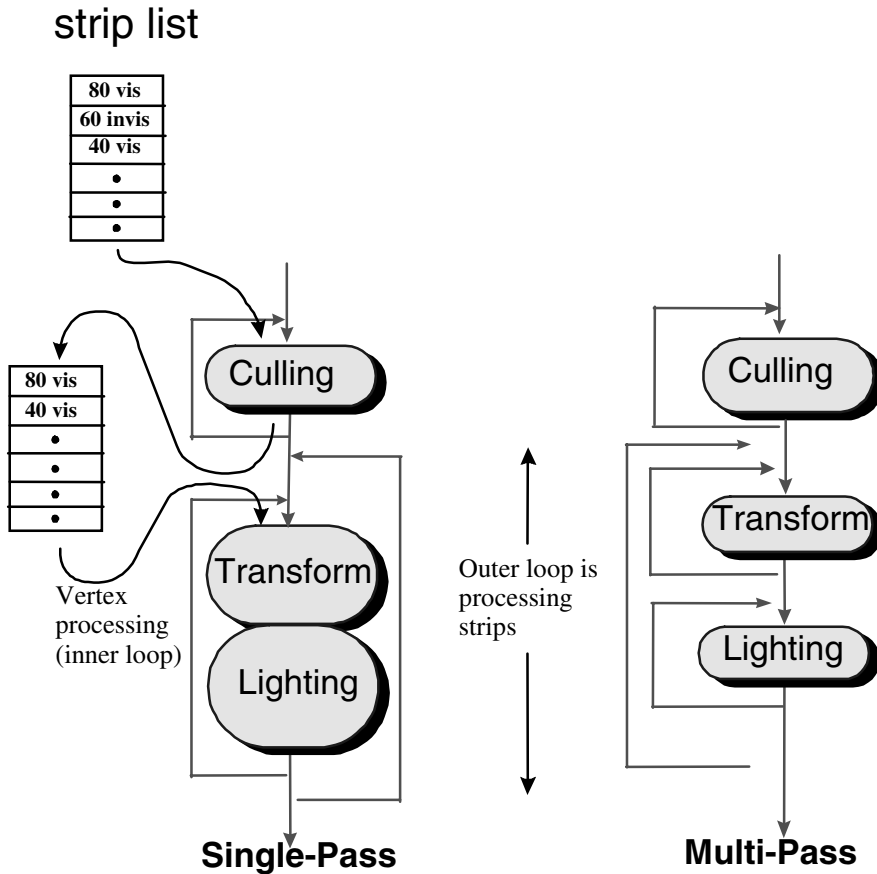

The choice of single-pass or multi-pass can have a number of performance implications. For instance, in a multi-pass pipeline, stages that are limited by bandwidth (either input or output) will reflect more of this performance limitation in overall execution time. In contrast, for a single-pass approach, bandwidth-limitations can be distributed/

amortized across other computation-intensive stages. Also, the choice of which prefetch hints to use are also impacted by whether a single-pass or multi-pass approach is used (see “Hardware Data Prefetch”).

Memory Optimization using Non-Temporal Stores

The non-temporal stores can also be used to manage data retention in the cache. Uses for the non-temporal stores include:

- To combine many writes without disturbing the cache hierarchy
- To manage which data structures remain in the cache and which are transient.

Detailed implementations of these usage models are covered in the following sections.

Non-temporal Stores and Software Write-Combining

Use non-temporal stores in the cases when the data to be stored is:

- write-once (non-temporal)
- too large and thus cause cache thrashing.

Non-temporal stores do not invoke a cache line allocation, which means they are not write-allocate. As a result, caches are not polluted and no dirty writeback is generated to compete with useful data bandwidth. Without using non-temporal stores, bus bandwidth will suffer when caches start to be thrashed because of dirty writebacks.

In Streaming SIMD Extensions implementation, when non-temporal stores are written into writeback or write-combining memory regions, these stores are weakly-ordered and will be combined internally inside the processor’s write-combining buffer and be written out to memory as a line burst transaction. To achieve the best possible performance, it is recommended to align data along the cache line boundary and write them consecutively in a cache line size while using non-temporal stores.

If the consecutive writes are prohibitive due to programming constraints, then software write-combining (swwc) buffers can be used to enable line burst transaction.

You can declare small swwc buffers (a cache line for each buffer) in your application to enable explicit write-combining operations. Instead of writing to non-temporal memory space immediately, the program writes data into swwc buffers and combines them inside these buffers. The program only writes a swwc buffer out using non-temporal stores when the buffer is filled up, that is, a cache line (128 bytes for the Pentium 4 processor). Although the swwc method requires explicit instructions for performing temporary writes and reads, this ensures that the transaction on the front-side bus causes line transaction rather than several partial transactions. Application performance gains considerably from implementing this technique. These SWWC buffers can be maintained in the second-level and re-used throughout the program.

Cache Management

The streaming instructions (`prefetch` and `stores`) can be used to manage data and minimize disturbance of temporal data held within the processor's caches.

In addition, the Pentium 4 processor takes advantage of the Intel C++ Compiler that supports C++ language-level features for the Streaming SIMD Extensions. The Streaming SIMD Extensions and MMX technology instructions provide intrinsics that allow you to optimize cache utilization. The examples of such Intel compiler intrinsics are `_mm_prefetch`, `_mm_stream`, `_mm_load`, `_mm_sfence`. For more details on these intrinsics, refer to the *Intel C++ Compiler User's Guide*, order number 718195.

The following examples of using prefetching instructions in the operation of video encoder and decoder as well as in simple 8-byte memory copy, illustrate performance gain from using the prefetching instructions for efficient cache management.

Video Encoder

In a video encoder example, some of the data used during the encoding process is kept in the processor's second-level cache, to minimize the number of reference streams that must be re-read from system memory. To ensure that other writes do not disturb the data in the second-level cache, streaming stores (`movntq`) are used to write around all processor caches.

The prefetching cache management implemented for the video encoder reduces the memory traffic. The second-level cache pollution reduction is ensured by preventing single-use video frame data from entering the second-level cache. Using a non-temporal prefetch (`prefetchnta`) instruction brings data into only one way of the second-level cache, thus reducing pollution of the second-level cache. If the data brought directly to second-level cache is not re-used, then there is a performance gain from the non-temporal prefetch over a temporal prefetch. The encoder uses non-temporal prefetches to avoid pollution of the second-level cache, increasing the number of second-level cache hits and decreasing the number of polluting write-backs to memory. The performance gain results from the more efficient use of the second-level cache, not only from the prefetch itself.

Video Decoder

In the video decoder example, completed frame data is written to local memory of the graphics card, which is mapped to `wc` (Write-combining) memory type. A copy of reference data is stored to the `wb` memory at a later time by the processor in order to generate future data. The assumption is that the size of the reference data is too large to fit in the processor's caches. A streaming store is used to write the data around the cache, to avoid displaying other temporal data held in the caches. Later, the processor re-reads the data using `prefetchnta`, which ensures maximum bandwidth, yet minimizes disturbance of other cached temporal data by using the non-temporal (NTA) version of prefetch.

Conclusions from Video Encoder and Decoder Implementation

These two examples indicate that by using an appropriate combination of non-temporal prefetches and non-temporal stores, an application can be designed to lessen the overhead of memory transactions by preventing second-level cache pollution, keeping useful data in the second-level cache and reducing costly write-back transactions. Even if an application does not gain performance significantly from having data ready from prefetches, it can improve from more efficient use of the second-level cache and memory. Such design reduces the encoder's demand for such critical resource as the memory bus. This makes the system more balanced, resulting in higher performance.

Using Prefetch and Streaming-store for a Simple Memory Copy

Consider a memory copy task to transfer a large array of 8-byte data elements from one memory location to another. Example 6-8 presents the basic algorithm of the simple memory copy. This task can be sped up greatly using prefetch and streaming store instructions. The techniques are discussed in the following paragraph and a code example is shown in Example 6-9.

Example 6-8 Basic Algorithm of a Simple Memory Copy

```
#define N 512000
double a[N], b[N];
for (i = 0; i < N; i++) {
    b[i] = a[i];
}
```

The memory copy algorithm can be optimized using the Streaming SIMD Extensions and these considerations:

- alignment of data
- proper layout of pages in memory

- cache size
- interaction of the transaction lookaside buffer (TLB) with memory accesses
- combining prefetch and streaming-store instructions.

The guidelines discussed in this chapter come into play in this simple example. TLB priming is required for the Pentium 4 processor just as it is for the Pentium III processor, since software prefetch instructions will not initiate page table walks on either processor.

TLB Priming

The TLB is a fast memory buffer that is used to improve performance of the translation of a virtual memory address to a physical memory address by providing fast access to page table entries. If memory pages are accessed and the page table entry is not resident in the TLB, a TLB miss results and the page table must be read from memory.

The TLB miss results in a performance degradation since another memory access must be performed (assuming that the translation is not already present in the processor caches) to update the TLB. The TLB can be preloaded with the page table entry for the next desired page by accessing (or touching) an address in that page. This is similar to prefetch, but instead of a data cache line the page table entry is being loaded in advance of its use. This helps to ensure that the page table entry is resident in the TLB and that the prefetch happens as requested subsequently.

Optimizing the 8-byte Memory Copy

Example 6-9 presents the copy algorithm that uses second level cache. The algorithm performs the following steps:

1. uses blocking technique to transfer 8-byte data from memory into second-level cache using the `_mm_prefetch` intrinsic, 128 bytes at a time to fill a block. The size of a block should be less than one half of the size of the second-level cache, but large enough to amortize the cost of the loop.
2. loads the data into an `xmm` register using the `_mm_load_ps` intrinsic.
3. transfers the 8-byte data to a different memory location via the `_mm_stream` intrinsics, bypassing the cache. For this operation, it is important to ensure that the page table entry prefetched for the memory is preloaded in the TLB.

Example 6-9 An Optimized 8-byte Memory Copy

```
#define PAGESIZE 4096;
#define NUMPERPAGE 512           // # of elements to fit a page

double a[N], b[N], temp;
for (kk=0; kk<N; kk+=NUMPERPAGE) {
    temp = a[kk+NUMPERPAGE];      // TLB priming
    // use block size = page size,
    // prefetch entire block, one cache line per loop
    for (j=kk+16; j<kk+NUMPERPAGE; j+=16) {
        _mm_prefetch((char*)&a[j], _MM_HINT_NTA);
    }
    // copy 128 byte per loop
    for (j=kk; j<kk+NUMPERPAGE; j+=16) {
        _mm_stream_ps((float*)&b[j],
            _mm_load_ps((float*)&a[j]));
        _mm_stream_ps((float*)&b[j+2],
            _mm_load_ps((float*)&a[j+2]));
        _mm_stream_ps((float*)&b[j+4],
            _mm_load_ps((float*)&a[j+4]));
        _mm_stream_ps((float*)&b[j+6],
            _mm_load_ps((float*)&a[j+6]));
    }
}
```

continued

Example 6-9 An Optimized 8-byte Memory Copy (continued)

```
    _mm_stream_ps((float*)&b[j+8],
                 _mm_load_ps((float*)&a[j+8]));
    _mm_stream_ps((float*)&b[j+10],
                 _mm_load_ps((float*)&a[j+10]));
    _mm_stream_ps((float*)&b[j+12],
                 _mm_load_ps((float*)&a[j+12]));
    _mm_stream_ps((float*)&b[j+14],
                 _mm_load_ps((float*)&a[j+14]));
} // finished copying one block
} // finished copying N elements
_mm_sfence();
```

In Example 6-9, eight `_mm_load_ps` and `_mm_stream_ps` intrinsics are used so that all of the data prefetched (a 128-byte cache line) is written back. The prefetch and streaming-stores are executed in separate loops to minimize the number of transitions between reading and writing data. This significantly improves the bandwidth of the memory accesses.

The instruction, `temp = a[kk+CACHESIZE]`, is used to ensure the page table entry for array, and `a` is entered in the TLB prior to prefetching. This is essentially a prefetch itself, as a cache line is filled from that memory location with this instruction. Hence, the prefetching starts from `kk+4` in this loop.

This example assumes that the destination of the copy is not temporally adjacent to the code. If the copied data is destined to be reused in the near future, then the streaming store instructions should be replaced with regular 128 bit stores (`_mm_store_ps`). This is required because the implementation of streaming stores on Pentium 4 processor writes data directly to memory, maintaining cache coherency.

Multiprocessor and Hyper-Threading Technology

7

This chapter describes software optimization techniques for multithreaded applications running on multiprocessor (MP) systems. The multiprocessor systems covered here include traditional systems using discrete microprocessors¹ and those using IA-32 processors with Hyper-Threading Technology².

Hyper-Threading Technology is discussed in Chapter 1. An IA-32 processor with Hyper-Threading Technology appears to software as two logical processors in one physical package. The performance gain using two discrete processors is greater than that gained using two logical processors in the same physical processor package. Nevertheless, there are many similarities in the performance characteristics between Hyper-Threading Technology and traditional MP systems. The programming models and optimization techniques for multi-threaded applications to take advantage of Hyper-Threading Technology and traditional MP system are also similar.

This chapter covers

- Performance characteristics and usage models,

1. Each processor is contained in a separate physical package.
2. The presence of Hyper-Threading Technology in IA-32 processors can be detected by reading the CPUID feature flag bit 28. A return value of 1 in bit 28 and at least two logical processors per package indicates that Hyper-Threading Technology is present in the processor. The number of logical processors supported in each package can also be obtained from CPUID. The application must also check how many logical processors are provided under the operating system by making the appropriate operating system calls. See the application notes “*Intel Processor Identification and the CPUID Instruction*” and “*Detecting Support for Hyper-Threading Technology Enabled Processors*” for more information.

- Programming models for multithreaded applications,
- Software optimization techniques in five specific areas.

Performance and Usage Models

The performance gains of using multiple processors or Hyper-Threading Technology are greatly affected by the usage model and the amount of parallelism in the control flow of the workload. Two common usage models are:

- multithreaded applications
- multitasking using single-threaded applications

Multithreading

When an application employs multi-threading to exploit task-level parallelism in a workload, the control flow of the multi-threaded software can be divided into two parts: parallel tasks and sequential tasks.

Amdahl's law describes an application's performance gain as it relates to the degree of parallelism in the control flow. It is a useful guide for selecting the code modules, functions, or instruction sequences that are most likely to realize the most gains from transforming sequential tasks and control flows into parallel code to take advantage MP systems and Hyper-Threading Technology.

Figure 7-1 illustrates how performance gains can be realized for any workload according to Amdahl's law. The bar in Figure 7-1 represents an individual task unit or the collective workload of an entire application.

In general, the speed-up of running multiple threads on an MP systems with N physical processors, over single-threaded execution, can be expressed as:

$$RelativeResponse = \frac{T_{sequential}}{T_{parallel}} = \left(1 - P + \frac{P}{N} + O\right)$$

where P is the fraction of workload that can be parallelized, and O represents the overhead of multithreading and may vary between different operating systems. In this case, performance gain is the inverse of the relative response.

Figure 7-1 Amdahl's Law and MP Speed-up

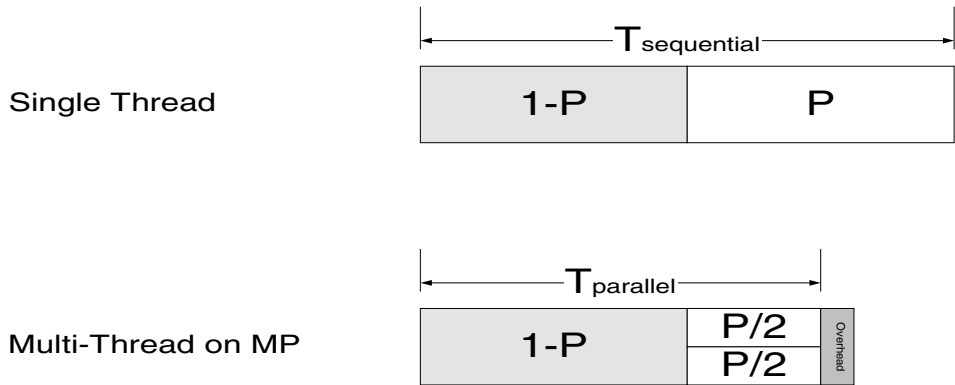

When optimizing application performance in a multithreaded environment, control flow parallelism is likely to have the largest impact on performance scaling with respect to the number of physical processors and to the number of logical processors per physical processor.

If the control flow of a multi-threaded application contains a workload in which only 50% can be executed in parallel, the maximum performance gain using two physical processors is only 33%, compared to using a single processor. Using four processors can deliver no more than a 60% speed-up over a single processor! Thus, it is critical to maximize the portion of control flow that can take advantage of parallelism. Improper implementation of thread synchronization can significantly increase the proportion of serial control flow and further reduce the application's performance scaling.

In addition to maximizing the parallelism of control flows, multithreaded applications should ensure each thread has good frequency scaling.

Excessive cache misses are one cause of poor performance scaling. In a multithreaded execution environment, they can occur from:

- aliased stack accesses by different threads in the same process
- thread contentions resulting in cache line evictions
- false-sharing of cache lines between different processors

Techniques that address each of these situations (and many other areas) are described in sections in this chapter.

Multitasking Environment

Hyper-Threading Technology can exploit task-level parallelism when a workload consists of several single-threaded applications and these applications are scheduled to run concurrently under an MP-aware operating system. In this environment, Hyper-Threading Technology can deliver higher throughput for the workload, although it does not increase the performance of an application (in terms of time of completion of each application).

For development purposes, several popular operating systems (for example Microsoft Windows* XP Professional and Home, Linux* distributions using kernel 2.4.19 or later³) include OS kernel code that can manage the task scheduling and the balancing of shared execution resources within each physical processor to maximize the throughput.

Because applications run independently under a multi-tasking environment, thread synchronization issues are less likely to limit the scaling of throughput. This is because the control flow of the workload is likely to be 100% parallel⁴ (if no inter-processor communication is taking place and if there are no system bus constraints).

3. This code is included in Red Hat* Linux Enterprise AS 2.1.

With a multi-tasking workload, however, bus activities and cache access patterns are likely to affect the scaling of the throughput. Running two copies of the same application or same suite of applications in a lock-step can expose an artifact in performance measuring methodology. This is because an access pattern to the 1st level data cache can lead to excessive cache misses and produce skewed performance results. Fix this problem by:

1. including a per-instance offset at the start-up of an application
2. introducing heterogeneity in the workload by using different datasets with each instance of the application
3. randomizing the sequence of start-up of applications when running multiple copies of the same suite

When two applications are employed as part of a multi-tasking workload, there is little synchronization overhead between these two processes. It is also important to ensure each application has minimal synchronization overhead within itself.

An application that uses lengthy spin loops for intra-process synchronization is less likely to benefit from Hyper-Threading Technology in a multi-tasking workload. This is because critical resources will be consumed by the long spin loops.

Programming Models and Multithreading

Parallelism is the most important concept in designing a multithreaded application and realizing optimal performance scaling with multiple processors. An optimized multithreaded application is characterized by large degrees of parallelism or minimal dependencies in the following areas:

- workload
4. A software tool that attempts to measure the throughput of a multi-tasking workload is likely to introduce additional control flows that are not parallel. For example, see Example 7-2 for coding pitfalls using spin-wait loop. Thus, thread synchronization issues must be considered as an integral part of its performance measuring methodology.

- thread interaction
- hardware utilization

The key to maximizing workload parallelism is to identify multiple tasks that have minimal inter-dependencies within an application and to create separate threads for parallel execution of those tasks.

Concurrent execution of independent threads is the essence of deploying a multithreaded application on a multiprocessing system. Managing the interaction between threads to minimize the cost of thread synchronization is also critical to achieving optimal performance scaling with multiple processors.

Efficient use of hardware resources between concurrent threads requires optimization techniques in specific areas to prevent contentions of hardware resources. Coding techniques for optimizing thread synchronization and managing other hardware resources are discussed in subsequent sections.

Parallel programming models are discussed next.

Parallel Programming Models

Two common programming models for transforming independent task requirements into application threads are:

- domain decomposition
- functional decomposition

Domain Decomposition

Usually large compute-intensive tasks use data sets that can be divided into a number of small subsets, each having a large degree of computational independence. Examples include:

- computation of a discrete cosine transformation (DCT) on two-dimensional data by dividing the two-dimensional data into several subsets and creating threads to compute the transform on each subset

- matrix multiplication; here, threads can be created to handle the multiplication of half of matrix with the multiplier matrix

Domain Decomposition is a programming model based on creating identical or similar threads to process smaller pieces of data independently. This model can take advantage of duplicated execution resources present in a traditional multiprocessor system. It can also take advantage of shared execution resources between two logical processors in Hyper-Threading Technology. This is because a data domain thread typically consumes only a fraction of the available on-chip execution resources.

The section “Key Practices of Execution Resource Optimization” discusses additional guidelines that can help data domain threads use shared execution resources cooperatively and avoid the pitfalls creating contentions of hardware resources between two threads.

Functional Decomposition

Applications usually process a wide variety of tasks with diverse functions and many unrelated data sets. For example, a video codec needs several different processing functions. These include DCT, motion estimation and color conversion. Using a functional threading model, applications can program separate threads to do motion estimation, color conversion, and other functional tasks.

Functional decomposition will achieve more flexible thread-level parallelism if it is less dependent on the duplication of hardware resources. For example, a thread executing a sorting algorithm and a thread executing a matrix multiplication routine are not likely to require the same execution unit at the same time. A design recognizing this could advantage of traditional multiprocessor systems as well as multiprocessor systems using IA-32 processor with Hyper-Threading Technology.

Tools for Creating Multithreaded Applications

Programming directly to a multithreading application programming interface (API) is not the only method for creating multithreaded applications. New tools such as the Intel® Compiler have become available with capabilities that make the challenge of creating multithreaded application easier.

Two features available in the latest Intel Compilers are:

- generating multithreaded code using OpenMP* directives⁵
- generating multithreaded code automatically from unmodified high-level code⁶

Programming with OpenMP Directives. OpenMP provides a standardized, non-proprietary, portable set of Fortran and C++ compiler directives supporting shared memory parallelism in applications. OpenMP supports directive-based processing. This uses special preprocessors or modified compilers to interpret parallelism expressed in Fortran comments or C/C++ pragmas. Benefits of directive-based processing include:

- The original source can be compiled unmodified.
- It is possible to make incremental code changes. This preserves algorithms in the original code and enables rapid debugging.
- Incremental code changes help programmers maintain serial consistency. When the code is run on one processor, it gives the same result as the unmodified source code.

Automatic Parallelization of Code. While OpenMP directives allow programmers to quickly transform serial applications into parallel applications, programmers must identify specific portions of the application code that contain parallelism and add compiler directives. Intel Compiler 6.0 supports a new (`-Qparallel`) option, which can identify loop structures that contain parallelism. During program

5. Intel Compiler 5.0 and later supports OpenMP directives. Visit <http://developer.intel.com/software/products> for details.
6. Intel Compiler 6.0 supports auto-parallelization.

compilation, the compiler automatically attempts to decompose the parallelism into threads for parallel processing. No other intervention or programmer is needed.

Supporting Development Tools. The Intel® Threading Tools include Intel® Thread Checker and Thread Profiler.

Intel® Thread Checker. Use Intel Thread Checker to find threading errors and reduce the amount of time spent debugging threaded applications.

Intel Thread Checker product is an Intel VTune Performance Analyzer plug-in data collector that executes a program and automatically locates threading errors. As the program runs, Intel Thread Checker monitors memory accesses and other events and automatically detects situations which could cause unpredictable threading-related results.

Thread Profiler. Thread Profiler is a plug-in data collector for the Intel VTune Performance Analyzer. Use it to analyze threading performance and identify parallel performance bottlenecks. It graphically illustrates what each OpenMP* thread is doing at various levels of detail using a hierarchical summary. Data is collapsed into relevant summaries, sorted to identify parallel regions or loops that require attention.

Optimization Guidelines

This section summarizes optimization guidelines for tuning multithreaded applications. Five areas are listed (in order of importance):

- thread synchronization
- bus utilization
- memory optimization
- front end optimization
- execution resource optimization

Practices associated with each area are listed in this section. Guidelines for each area are discussed in greater depth in sections that follow.

Most of the coding recommendations improve performance scaling with physical processors and scaling due to Hyper-Threading Technology. Techniques that apply to only one environment are noted.

Key Practices of Thread Synchronization

Key practices for minimizing the cost of thread synchronization are summarized below:

- Insert the `PAUSE` instruction in fast spin loops and keep the number of loop repetitions to a minimum to improve overall system performance.
- Replace a spin lock that may be acquired by multiple threads with pipelined locks such that no more than two threads have write accesses to one lock. If only one thread needs to write to a variable shared by two threads, there is no need to acquire a lock.
- Use a thread-blocking API in a long idle loop to free up the processor.
- Prevent “false-sharing” of per-thread-data between two threads.
- Place each synchronization variable alone, separated by 128 bytes or in a separate cache line.

See “Thread Synchronization” for more details.

Key Practices of System Bus Optimization

Managing bus traffic can significantly impact the overall performance of multithreaded software and MP systems. Key practices of system bus optimization for achieving high data throughput and quick response are:

- Improve data and code locality to conserve bus command bandwidth.

- Avoid excessive use of software prefetch instructions and allow the automatic hardware prefetcher to work. Excessive use of software prefetches can significantly and unnecessarily increase bus utilization if used inappropriately.
- Consider using overlapping multiple back-to-back memory reads to improve effective cache miss latencies.
- Use full write transactions to achieve higher data throughput.

See “System Bus Optimization” for more details.

Key Practices of Memory Optimization

Key practices for optimizing memory operations are summarized below:

- Use cache blocking to improve locality of data access. Target one quarter to one half of cache size when targeting IA-32 processors with Hyper-Threading Technology.
- Minimize the sharing of data between threads that execute on different physical processors sharing a common bus.
- Minimize data access patterns that are offset by multiples of 64 KB in each thread.
- Adjust the private stack of each thread in an application so the spacing between these stacks is not offset by multiples of 64 KB or 1 MB (prevents unnecessary cache line evictions) when targeting IA-32 processors with Hyper-Threading Technology.
- Add a per-instance stack offset when two instances of the same application are executing in lock steps to avoid memory accesses that are offset by multiples of 64 KB or 1 MB when targeting IA-32 processors with Hyper-Threading Technology.

See “Memory Optimization” for more details.

Key Practices of Front-end Optimization

Key practices for front-end optimization are:

- Avoid Excessive Loop Unrolling to ensure the Trace Cache is operating efficiently.
- Optimize code size to improve locality of Trace Cache and increase delivered trace length.

See “Front-end Optimization” for more details.

Key Practices of Execution Resource Optimization

Each physical processor has dedicated execution resources. Logical processors in physical processors supporting Hyper-Threading Technology share specific on-chip execution resources. Key practices for execution resource optimization include:

- Optimize each thread to achieve optimal frequency scaling first.
- Optimize multithreaded applications to achieve optimal scaling with respect to the number of physical processors.
- Use on-chip execution resources cooperatively if two threads are sharing the execution resources in the same physical processor package.
- For each processor with Hyper-Threading Technology, consider adding functionally uncorrelated threads to increase the hardware resource utilization of each physical processor package.

See “Execution Resource Optimization” for more details.

Generality and Performance Impact

The next five sections cover the optimization techniques in detail. Recommendations discussed in each section are ranked by importance in terms of estimated local impact and generality.

Rankings are subjective and approximate. They can vary depending on coding style, application and threading domain. The purpose of including high, medium and low impact ranking with each recommendation is to provide a relative indicator as to the degree of performance gain that can be expected when a recommendation is implemented.

It is not possible to predict the frequency of a code instance in an applications, so an impact ranking cannot be directly correlated to application-level performance gain. The ranking on generality is also subjective and approximate.

Coding recommendations that do not impact all three scaling factors are typically categorized as medium or lower.

Thread Synchronization

Applications with multiple threads use synchronization techniques in order to ensure correct operation. However, thread synchronization that are improperly implemented can significantly reduce performance.

Several coding techniques and operating system (OS) calls that are frequently used for thread synchronization. These include spin-wait loops, spin-locks, critical sections, to name a few. Choosing the optimal OS calls for the circumstance and implementing synchronization code with parallelism in mind are critical in minimizing the cost of handling thread synchronization.

Synchronization for Short Periods

The frequency and duration that a thread needs to synchronize with other threads depends application characteristics. When a synchronization loop needs very fast response, applications may use a spin-wait loop.

A spin-wait loop is typically used when one thread needs to wait a short amount of time for another thread to reach a point of synchronization. A spin-wait loop consists of a loop that compares a synchronization variable with some pre-defined value [see Example 7-1(a)].

On a modern microprocessor with a superscalar speculative execution engine, a loop like this results in the issue of multiple simultaneous read requests from the spinning thread. These requests usually execute out-of-order with each read request being allocated a buffer resource. On detection of a write by a worker thread to a load that is in progress, the processor must guarantee no violations of memory order occur. The necessity of maintaining the order of outstanding memory operations inevitably costs the processor a severe penalty that impacts all threads.

This penalty occurs on the Pentium Pro processor, the Pentium II processor and the Pentium III processor. However, the penalty on these processors is small compared with penalties suffered on the Pentium 4 and Intel Xeon processors. There the performance penalty for exiting the loop is about 25 times more severe.

On a processor with Hyper-Threading Technology, spin-wait loops can consume a significant portion of the execution bandwidth of the processor. One logical processor executing a spin-wait loop can severely impact the performance of the other logical processor.

Example 7-1 Spin-wait Loop and PAUSE Instructions

(a) An un-optimized spin-wait loop experiences performance penalty when exiting the loop. It consumes execution resources without contributing computational work.

```
do {  
    // this loop can run faster than the speed of memory access,  
    // other worker threads cannot finish modifying sync_var until  
    // outstanding loads from the spinning loops are resolved.  
} while( sync_var != constant_value)
```

(b) Inserting the PAUSE instruction in a fast spin-wait loop prevents performance-penalty to the spinning thread and the worker thread

```
do {  
    _asm    pause  
    // ensure this loop is de-pipelined, i.e. preventing more than  
one  
    // load request to sync_var to be outstanding,  
    // avoiding performance penalty when the worker thread updates  
    // sync_var and the spinning thread exiting the loop  
}  
while( sync_var != constant_value)
```

continued

Example 7-1 Spin-wait Loop and PAUSE Instructions (continued)

(c) A spin-wait loop using a “test, test-and-set” technique to determine the availability of the synchronization variable. This technique is recommended when writing spin-wait loops to run on IA-32 architecture processors.

Spin_Lock:

```
CMP lockvar, 0 ; Check if lock is free
JE  Get_lock
    PAUSE                ; Short delay
    JMP Spin_Lock
```

Get_Lock:

```
MOV EAX, 1
XCHG EAX, lockvar ; Try to get lock
CMP EAX, 0 ; Test if successful
JNE Spin_Lock
```

Critical_Section:

```
<critical section code>
MOV lockvar, 0 ; Release lock
```

User/Source Coding Rule 20. (M impact, H generality) *Insert the PAUSE instruction in fast spin loops and keep the number of loop repetitions to a minimum to improve overall system performance.*

On IA-32 processors that use the Intel NetBurst microarchitecture core, the penalty of exiting from a spin-wait loop can be avoided by inserting a PAUSE instruction in the loop. In spite of the name, the PAUSE instruction improves performance by introducing a slight delay in the loop and effectively causing the memory read requests to be issued at a rate that allows immediate detection of any store to the synchronization variable. This prevents the occurrence of a long delay due to memory order violation.

One example of inserting the `PAUSE` instruction in a simplified spin-wait loop is shown in Example 7-1(b). The `PAUSE` instruction is compatible with all IA-32 processors. On IA-32 processors prior to Intel NetBurst microarchitecture, the `PAUSE` instruction is essentially a `NOP` instruction. Additional examples of optimizing spin-wait loops using the `PAUSE` instruction are available in Application Note AP-949 “Using Spin-Loops on Intel Pentium 4 Processor and Intel Xeon Processor.”

Inserting the `PAUSE` instruction has the added benefit of significantly reducing the power consumed during the spin-wait because fewer system resources are used.

Optimization with Spin-Locks

Spin-locks are typically used when several threads need to modify a synchronization variable and the synchronization variable must be protected by a lock to prevent un-intentional overwrites. When the lock is released, however, several threads may compete to acquire it at once. Such thread contention significantly reduces performance scaling with respect to frequency, number of discrete processors, and Hyper-Threading Technology.

To reduce the performance penalty, one approach is to reduce the likelihood of many threads competing to acquire the same lock. Apply a software pipelining technique to handle data that must be shared between multiple threads.

Instead of allowing multiple threads to compete for a given lock, no more than two threads should have write access to a given lock. If an application must use spin-locks, include the `PAUSE` instruction in the wait loop. Example 7-1 (c) shows an example of the “test, test-and-set” technique for determining the availability of the lock in a spin-wait loop.

User/Source Coding Rule 21. (M impact, L generality) *Replace a spin lock that may be acquired by multiple threads with pipelined locks such that no more than two threads have write accesses to one lock. If only one thread needs to write to a variable shared by two threads, there is no need to use a lock,*

Synchronization for Longer Periods

When using a spin-wait loop not expected to be released quickly, an application should follow these guidelines:

- Keep the duration of the spin-wait loop to a minimum number of repetitions.
- Applications should use an OS service to block the waiting thread; this can release the processor so that other runnable threads can make use of the processor or available execution resources.

On processors supporting Hyper-Threading Technology, operating systems should use the HLT instruction if one logical processor is active and the other is not. HLT will allow an idle logical processor to transition to a halted state; this allows the active logical processor to use all the hardware resources in the physical package. An operating system that does not use this technique must still execute instructions on the idle logical processor that repeatedly check for work. This “idle loop” consumes execution resources that could otherwise be used to make progress on the other active logical processor.

If an application thread must remain idle for a long time, the application should use a thread blocking API or other method to release the idle processor. The techniques discussed here apply to traditional MP system, but they have an even higher impact on IA-32 processors that support Hyper-Threading Technology.

Typically, an operating system provides timing services, for example `Sleep(dwMilliseconds)`⁷; such variables can be used to prevent frequent checking of a synchronization variable.

Another technique to synchronize between worker threads and a control loop is to use a thread-blocking API provided by the OS. Using a thread-blocking API allows the control thread to use less processor

7. The `Sleep()` API is not thread-blocking, because it does not guarantee the processor will be released.
Example 7-2 (a) shows an example of using `Sleep(0)`, which does not always realize the processor to another thread.

cycles for spinning and waiting. This gives the OS more time quanta to schedule the worker threads on available processors. Furthermore, using a thread-blocking API also benefits from the system idle loop optimization that OS implements using the HLT instruction.

User/Source Coding Rule 22. (H impact, M generality) *Use a thread-blocking API in a long idle loop to free up the processor.*

Using a spin-wait loop in a traditional MP system may be less of an issue when the number of runnable threads is less than the number of processors in the system. If the number of threads in an application is expected to be greater than the number of processors (either one processor or multiple processors), use a thread-blocking API to free up processor resources. A multithreaded application adopting one control thread to synchronize multiple worker threads may consider limiting worker threads to the number of processors in a system and use thread-blocking APIs in the control thread.

Avoid Coding Pitfalls in Thread Synchronization

Synchronization between multiple threads must be designed and implemented with care to achieve good performance scaling with respect to the number of discrete processors and the number of logical processor per physical processor. No single technique is a universal solution for every synchronization situation.

The pseudo-code example in Example 7-2 (a) illustrates a polling loop implementation of a control thread. If there is only one runnable worker thread, an attempt to call a timing service API, such as Sleep(0), may be ineffective in minimizing the cost of thread synchronization. Because the control thread still behaves like a fast spinning loop, the only runnable worker thread must share execution resources with the spin-wait loop if both are running on the same physical processor that supports Hyper-Threading Technology. If there are more than one runnable worker threads, then calling a thread blocking API, such as Sleep(0), could still release the processor running the spin-wait loop, allowing the processor to be used by another worker thread instead of the spinning loop.

Example 7-2 Coding Pitfall using Spin Wait Loop

(a) A spin-wait loop attempts to release the processor incorrectly. It experiences a performance penalty if the only worker thread and the control thread runs on the same physical processor package.

```
// Only one worker thread is running,  
// the control loop waits for the worker thread to complete  
ResumeWorkThread(thread_handle);  
While (!task_not_done ) {  
    Sleep(0)    // Returns immediately back to spin loop  
    ...  
}
```

(b) A polling loop frees up the processor correctly.

```
// Let a worker thread run and wait for completion  
ResumeWorkThread(thread_handle);  
While (!task_not_done ) {  
    Sleep(FIVE_MILLISEC)  
    // This processor is released for some duration, the processor can  
    be  
    // used by other threads  
    ...  
}
```

A control thread waiting for the completion of worker threads can usually implement thread synchronization using a thread-blocking API or a timing service, if the worker threads require significant time to complete. Example 7-2 (b) shows an example that reduces the overhead of the control thread in its thread synchronization.

In general, OS function calls should be used with care when synchronizing threads. When using OS-supported thread synchronization objects (critical section, mutex, or semaphore), preference should be given to the OS service that has the least synchronization overhead, such as a critical section.

Prevent False-Sharing of Data

When two threads must share data, it is important to avoid false sharing. False sharing applies to data used by one thread that happens to reside on the same cache line as different data used by another thread.

An example of false sharing is when thread-private data and a thread synchronization variable are located within the line size boundary (64 bytes) or sector boundary (128 bytes). When one thread modifies the synchronization variable, the “dirty” cache line must be written out to memory and updated for each physical processor sharing the bus. Subsequently, data is fetched into each target processor 128 bytes at a time, causing previously cached data to be evicted from its cache on each target processor. False-sharing incurs a performance penalty, when two threads run on different physical processors or on two logical processors in the physical processor package. In the first case, the performance penalty is due to cache evictions to maintain cache coherency. In the latter case, performance penalty is due to memory order machine clear conditions.

User/Source Coding Rule 23. (H impact, M generality) *Beware of false sharing within a cache line (64 bytes on Intel Pentium 4, Intel Xeon and Pentium M processors), and within a sector (128 bytes on Pentium 4 and Intel Xeon processors).*

When a common block of parameters is passed from a parent thread to several worker threads, it is desirable for each work thread to create a private copy of frequently accessed data in the parameter block.

Placement of Shared Synchronization Variable

Because bus reads typically fetch 128 bytes into a cache, the optimal spacing to minimize eviction of cached data is 128 bytes. To prevent false-sharing, synchronization variables and system objects (such as a critical section) should be allocated to reside alone in a 128-byte region and aligned to a 128-byte boundary. Example 7-3 shows a way to minimize the bus traffic required to maintain cache coherency in MP systems. This technique is also applicable to MP systems using IA-32 processors with or without Hyper-Threading Technology.

User/Source Coding Rule 24. (M impact, ML generality) *Place each synchronization variable alone, separated by 128 bytes or in a separate cache line.*

User/Source Coding Rule 25. (H impact, L generality) *Do not place any spin lock variable to span a cache line boundary (64 bytes on Intel Pentium 4 and Intel Xeon processors).*

Example 7-3 Placement of Synchronization and Regular Variables

```
int regVar;  
int padding[32];  
int SynVar[32*NUM_SYNC_VARS];  
int AnotherVar;
```

System Bus Optimization

The system bus supports a maximum data rate of 3.2 Gigabytes per second (GB/S) at 400 MHz, or 4.2 GB/s at 533 MHz. The bus has a line size of 64 bytes and can fetch two lines. This means that 128 bytes of data can be fetched from memory as the result of a cache miss. The high data rate is achieved only when bus transactions use the full capacity of each line. While read and prefetch transactions across the bus are conducted at 64-byte line size or 128 bytes at a time, write transactions can occur in full or various partial line sizes. Conducting partial write transactions not only reduces the effective data rate of the system bus,

but each request for a partial write transaction also consumes the finite command bandwidth of the system bus. When both logical processors in an IA-32 processor that supports Hyper-Threading Technology are active, each logical processor is an agent that can initiate requests for bus transactions.

Conserve Bus Command Bandwidth

In an N-way MP system with IA-32 processors supporting Hyper-Threading Technology, there are twice as many agents that can issue bus transaction requests. Preserving the bus command bandwidth can help each bus agent achieve higher performance.

One way for conserving available bus command bandwidth is to improve the locality of code and data. Improving the locality of data reduces the number of cache line evictions and requests to fetch data. This technique also reduces the number of instruction fetches from system memory.

User/Source Coding Rule 26. (M impact, H generality) *Improve data and code locality to conserve bus command bandwidth.*

Using a compiler that supports profiler-guided optimization can improve code locality by keeping frequently used code paths in the cache. This reduces instruction fetches. Loop blocking can also improve the data locality.

Avoid Excessive Software Prefetches

Pentium 4 and Intel Xeon Processors have an automatic hardware prefetcher. It can bring data and instructions into the unified second-level cache based on prior reference patterns. In most situations, the hardware prefetcher is likely to reduce system memory latency without explicit intervention from software prefetches. Using software prefetch instructions excessively or indiscriminately will inevitably

cause performance penalties. This is because excessively or indiscriminately using software prefetch instructions wastes the command and data bandwidth of the system bus.

Using software prefetches delays the hardware prefetcher from starting to fetch data needed by the processor core. It also consumes critical execution resources and can result in stalled execution. The guidelines for using software prefetch instructions are described in Chapter 2. The calculation of prefetch-ahead distance is discussed in Chapter 6.

User/Source Coding Rule 27. (M impact, L generality) *Avoid excessive use of software prefetch instructions and allow automatic hardware prefetcher to work. Excessive use of software prefetches can significantly and unnecessarily increase bus utilization if used inappropriately.*

Improve Effective Latency of Cache Misses

System memory access latency due to cache misses is affected by bus traffic. This is because bus read requests must be arbitrated along with other requests for bus transactions. Reducing the number of outstanding bus transactions helps improve effective memory access latency.

One technique to improve effective latency of memory read transactions is to use multiple overlapping bus reads to reduce the latency of sparse reads. In situations where there is little locality of data or when memory reads need to be arbitrated with other bus transactions, the effective latency of scattered memory reads can be improved by issuing multiple memory reads back-to-back to overlap multiple outstanding memory read transactions. The average latency of back-to-back bus reads is likely to be lower than the average latency of scattered reads interspersed with other bus transactions. This is because only the first memory read needs to wait for the full delay of a cache miss.

User/Source Coding Rule 28. (M impact, M generality) *Consider using overlapping multiple back-to-back memory reads to improve effective cache miss latencies.*

Use Full Write Transactions to Achieve Higher Data Rate

Write transactions across the bus can result in write to physical memory either using the full line size of 64 bytes or less than the full line size. The latter is referred to as a partial write. Typically, writes to writeback (WB) memory addresses are full-size and writes to write-combine (WC) or uncacheable (UC) type memory addresses result in partial writes. Both cached WB store operations and WC store operations utilize a set of six WC buffers (64 bytes wide) to manage the traffic of write transactions. When competing traffic closes a WC buffer before all writes to the buffer are finished, this results in a series of 8-byte partial bus transactions rather than a single 64-byte write transaction.

User/Source Coding Rule 29. (M impact, M generality) *Use full write transactions to achieve higher data throughput.*

Frequently, multiple partial writes to WC memory can be combined into full-sized writes using a software write-combining technique to separate WC store operations from competing with WB store traffic. To implement software write-combining, uncacheable writes to memory with the WC attribute are written to a small, temporary buffer (WB type) that fits in the first level data cache. When the temporary buffer is full, the application copies the content of the temporary buffer to the final WC destination.

When partial-writes are transacted on the bus, the effective data rate to system memory is reduced to only 1/8 of the system bus bandwidth.

Memory Optimization

Efficient operation of caches is the most important aspect of memory optimization. Efficient operation of caches by:

- cache blocking
- shared memory optimization
- eliminating 64-K-Aliased data accesses
- preventing excessive evictions in first-level cache

Cache Blocking Technique

Loop blocking is useful for reducing cache misses and improving memory access performance. The selection of a suitable block size is critical when applying the loop blocking technique. Loop blocking is applicable to single-threaded applications as well as to multithreaded applications running on processors with or without Hyper-Threading Technology. The technique transforms the memory access pattern into blocks that efficiently fit in the target cache size.

When targeting IA-32 processors with Hyper-Threading Technology, the loop blocking technique should select a block size that is no more than one half of the target cache size. The upper limit of the block size for loop blocking should be determined by dividing the target cache size by the number of logical processors available in a physical processor package. Typically, some cache lines are needed to access data that are not part of the source or destination buffers used in cache blocking, so the block size can be chosen between one quarter to one half of the target cache (see also, Chapter 3).

User/Source Coding Rule 30. (H impact, H generality) *Use cache blocking to improve locality of data access. Target one quarter to one half of the cache size when targeting IA-32 processors with Hyper-Threading Technology.*

Shared-Memory Optimization

Maintaining cache coherency between discrete processors frequently involves moving data across a bus that operates at a clock rate substantially slower than the processor frequency.

Minimize Sharing of Data between Physical Processors

When two threads are executing on two physical processors and sharing data, reading from or writing to shared data usually involves several bus transactions (including snooping, request for ownership changes, and

sometimes fetching data across the bus). A thread accessing a large amount of shared memory is not likely to scale with processor clock rates.

User/Source Coding Rule 31. (H impact, M generality) *Minimize the sharing of data between threads that execute on different physical processors sharing a common bus.*

One technique to minimize sharing of data is to copy data to local stack variables if it is to be accessed repeatedly over an extended period. If necessary, results from multiple threads can be combined later by writing them back to a shared memory location. This approach can also minimize time spent to synchronize access to shared data.

Eliminate 64-K-Aliased Data Accesses

The 64 KB aliasing condition is discussed in Chapter 2. Memory accesses that satisfy the 64 KB aliasing condition can cause excessive evictions of the first-level data cache. Eliminating 64-KB-aliased data accesses originating from each thread helps improve frequency scaling in general. Furthermore, it enables the first-level data cache to perform efficiently when Hyper-Threading Technology is fully utilized by software applications.

User/Source Coding Rule 32. (H impact, H generality) *Minimize data access patterns that are offset by multiples of 64 KB in each thread.*

The presence of 64-KB-aliased data access can be detected using Pentium 4 processor performance monitoring events. Appendix B includes an updated list of Pentium 4 processor performance metrics. These metrics are based on events accessed using the Intel VTune performance analyzer.

Performance penalties associated with 64 KB aliasing are applicable mainly to current processor implementations of Hyper-Threading Technology or Intel NetBurst microarchitecture. The next section

discusses a memory optimization techniques that are applicable only to multithreaded applications running on processors with Hyper-Threading Technology.

Preventing Excessive Evictions in First-Level Data Cache

Cached data in a first-level data cache are indexed to linear addresses but physically tagged. Data in second-level and third-level caches are tagged and indexed to physical addresses. While two logical processors in the same physical processor package execute in separate linear address space, the same processors can reference data at the same linear address in two address spaces but mapped to different physical addresses. When such competing accesses occur simultaneously, they can cause repeated evictions and allocations of cache lines in the first-level data cache. Preventing unnecessary evictions in the first-level data cache by two competing threads improves the temporal locality of the first-level data cache.

Multithreaded applications need to prevent unnecessary evictions in the first-level data cache when:

- Multiple threads within an application try to access private data on their stack, some data access patterns can cause excessive evictions of cache lines. Within the same software process, multiple threads have their respective stacks, and these stacks are located at different linear addresses. Frequently the linear addresses of these stacks are spaced apart by some fixed distance that increases the likelihood of a cache line being used by multiple threads.
- Two instances of the same application run concurrently and are executing in lock steps (for example, corresponding data in each instance are accessed more or less synchronously), accessing data on the stack (and sometimes accessing data on the heap) by these two processes can also cause excessive evictions of cache lines because of address conflicts.

Per-thread Stack Offset

To prevent private stack accesses in concurrent threads from thrashing the first-level data cache, an application can use a per-thread stack offset for each of its threads. The size of these offsets should be multiples of a common base offset. The optimum choice of this common base offset may depend on the memory access characteristics of the threads; but it should be multiples of 128 bytes.

One effective technique for choosing a per-thread stack offset in an application is to add an equal amount of stack offset each time a new thread is created in a thread pool.⁸ Example 7-4 shows a code fragment that implements per-thread stack offset for three threads using a reference offset of 1024 bytes.

User/Source Coding Rule 33. (H impact, M generality) *Adjust the private stack of each thread in an application so that the spacing between these stacks is not offset by multiples of 64 KB or 1 MB to prevent unnecessary cache line evictions, when using IA-32 processors with Hyper-Threading Technology.*

8. For parallel applications written to run with OpenMP, the OpenMP runtime library in Intel KAP/Pro Toolset automatically provides the stack offset adjustment for each thread.

Example 7-4 Adding an Offset to the Stack Pointer of Three Threads

```
Void Func_thread_entry(DWORD *pArg)
{DWORD StackOffset = *pArg;
DWORD var1; // The local variable at this scope may not benefit
DWORD var2; // from the adjustment of the stack pointer that ensue

// call runtime library routine to offset stack pointer
_alloca(StackOffset) ;
}
// Managing per-thread stack offset to create three threads:
// * Code for the thread function
// * Stack accesses within descendant functions (do_foo1, do_foo2)
are // less likely to cause data cache evictions because of the
stack
// offset.
do_foo1();
do_foo2();
}
main ()
{ DWORD Stack_offset, ID_Thread1, ID_Thread2, ID_Thread3;
Stack_offset = 1024;
    // stack offset between parent thread and the first child thread
ID_Thread1 = CreateThread(Func_thread_entry, &Stack_offset);
    // call OS thread API
Stack_offset = 2048;
ID_Thread2 = CreateThread(Func_thread_entry, &Stack_offset);
Stack_offset = 3072;
ID_Thread3 = CreateThread(Func_thread_entry, &Stack_offset);
}
```

Example 7-5 Adding an Offset to the Stack Pointer of Three Threads

```
{ DWORD Stack_offset, ID_Thread1, ID_Thread2, ID_Thread3;
Stack_offset = 1024;
    // stack offset between parent thread and the first child thread
ID_Thread1 = CreateThread(Func_thread_entry, &Stack_offset);
    // call OS thread API
Stack_offset = 2048;
ID_Thread2 = CreateThread(Func_thread_entry, &Stack_offset);
Stack_offset = 3072;
ID_Thread3 = CreateThread(Func_thread_entry, &Stack_offset);
}
```

Per-instance Stack Offset

Each instance an application runs in its own linear address space; but the address layout of data for stack segments is identical for the both instances. When the instances are running in lock step, stack accesses are likely to cause excessive evictions of cache lines in the first-level data cache for some implementations of Hyper-Threading Technology in IA-32 processors.

Although this situation (two copies of an application running in lock step) is seldom an objective for multithreaded software or a multiprocessor platform, it can happen by an end-user's direction. One solution is to allow application instance to add a suitable linear address-offset for its stack. Once this offset is added at start-up, a buffer of linear addresses is established even when two copies of the same application are executing using two logical processors in the same physical processor package. The space has negligible impact on running dissimilar applications and on executing multiple copies of the same application.

However, the buffer space does enable the first-level data cache to be shared cooperatively when two copies of the same application are executing on the two logical processors in a physical processor package.

To establish a suitable stack offset for two instances of the same application running on two logical processors in the same physical processor package, the stack pointer can be adjusted in the entry function of the application using the technique shown in Example 7-5. The size of stack offsets should also be a multiple of a reference offset that may depend on the characteristics of the application's data access pattern. One way to determine the per-instance value of the stack offsets is to choose a pseudo-random number that is also a multiple of the reference offset or 128 bytes. Usually, this per-instance pseudo-random offset can be less than 7 KB. Example 7-5 provides a code fragment for adjusting the stack pointer in an application entry function.

User/Source Coding Rule 34. (M impact, L generality) *Add per-instance stack offset when two instances of the same application are executing in lock steps to avoid memory accesses that are offset by multiples of 64 KB or 1 MB, when targeting IA-32 processors with Hyper-Threading Technology.*

Example 7-6 Adding a Pseudo-random Offset to the Stack Pointer in the Entry Function

```
void main()
{char * pPrivate = NULL;
long myOffset = GetMod7Krandom128X()
    ; a pseudo-random number that is a multiple
    ; of 128 and less than 7K
    //      ; use runtime library routine to reposition
    _alloca(myOffset); // the stack pointer
}
// the rest of application code below, stack accesses in descendant
// functions (e.g. do_foo) are less likely to cause data cache
// evictions because of the stack offsets.
do_foo();
}
```

Front-end Optimization

In the Intel NetBurst microarchitecture family of processors, the instructions are decoded into micro-ops (μ ops) and sequences of μ ops (called traces) are stored in the Execution Trace Cache. The Trace Cache is the primary sub-system in the front end of the processor that delivers μ op traces to the execution engine. Optimization guidelines for front-end operation in single-threaded applications are discussed in Chapter 2.

This section discusses guidelines for optimizing the operation of the Execution Trace Cache on IA-32 processors with Hyper-Threading Technology.

Avoid Excessive Loop Unrolling

Unrolling loops can reduce the number of branches and improve the branch predictability of application code. Loop unrolling is discussed in detail in Chapter 2. Loop unrolling must be used judiciously. Be sure to consider the benefit of improved branch predictability and the cost of increased code size relative to the Trace Cache.

User/Source Coding Rule 35. (M impact, L generality) *Avoid excessive loop unrolling to ensure the Trace cache is operating efficiently.*

On Hyper-Threading-Technology-enabled processors, excessive loop unrolling is likely to reduce the Trace Cache's ability to deliver high bandwidth μ op streams to the execution engine.

Optimization for Code Size

When the Trace Cache is continuously and repeatedly delivering μ op traces that are pre-built, the scheduler in the execution engine can dispatch μ ops for execution at a high rate and maximize the utilization of available execution resources. Optimizing application code size by

organizing code sequences that are repeatedly executed into sections, each with a footprint that can fit into the Trace Cache, can improve application performance greatly.

On Hyper-Threading-Technology-enabled processors, multithreaded applications should improve code locality of frequently executed sections and target one half of the size of Trace Cache for each application thread when considering code size optimization. If code size becomes an issue affecting the efficiency of the front end, this may be detected by evaluating performance metrics discussed in the previous sub-section with respect to loop unrolling.

User/Source Coding Rule 36. (L impact, L generality) *Optimize code size to improve locality of Trace cache and increase delivered trace length.*

Execution Resource Optimization

For applications based on the domain decomposition threading model, optimization techniques with respect to execution resources are essentially the same as single-threaded applications in the absence of Hyper-Threading Technology. Each thread should be optimized to achieved optimal frequency scaling first. Then, optimization in an area such as thread synchronization can improve MP scaling to supplement good frequency scaling.

Hyper-Threading Technology enables several threads to run simultaneously on a physical processor while sharing on-chip execution resources. There may be instances where one thread has a high resource utilization rate, which may be indicated by a low cycle per instruction (CPI) value. In these special situations, additional domain decomposition threads may not be able to take advantage of Hyper-Threading Technology to increase application performance. However, for the majority of applications, the average utilization rate of execution resources is low compared to the processor's peak execution bandwidth.

To help multithreaded applications utilize shared execution resources effectively, this section describes guidelines to deal with common situations as well as those limited situations where execution resource utilization between threads may impact overall performance of the application in a multiprocessor system with Hyper-Threading Technology.

Optimization Priorities

There are three aspects of performance scaling:

- frequency scaling
- scaling to the number of discrete processors
- scaling to the number of logical processor per physical processor package

These three factors can be largely orthogonal in most cases, if code-tuning efforts follow the order of priorities listed below:

Tuning Suggestion 3. (H Impact, H Generality) *Optimize single threaded code to achieve optimal frequency scaling first.*

Most applications only use about 20-30% of peak execution resources when running on modern high-end processors. Execution of a single thread can scale well with processor frequency while leaving substantial execution bandwidth and issue bandwidth unused. For example, most applications that scale well with frequency seldom use the issue bandwidth of 3 μ ops per cycle in the Pentium 4 and Intel Xeon processors. Optimizing single-threaded code for frequency scaling builds the foundation for multithreaded applications to take advantage of the frequency headroom in Intel NetBurst microarchitecture.

Tuning Suggestion 4. (M Impact, M Generality) *The next priority (after tuning for frequency scaling) is to optimize multithreaded applications to achieve optimal scaling with respect to the number of physical processors.*

Following the guidelines for thread synchronization and conserving bus bandwidth can increase the degree of task-level parallelism and improve MP scaling. Highly parallel application threads can utilize the performance potential of multiple discrete processors much more effectively than applications with less parallelism. Application code with high degree of MP scaling is also more likely to take advantage of the performance potential of Hyper-Threading Technology.

Tuning Suggestion 5. (M Impact, L Generality) *Use on-chip execution resources cooperatively if two threads are sharing the execution resources in the same physical processor package.*

Using functional threading model, a multithreaded application can add additional threads and use the execution resources within a physical processors effectively. The concept of functional threading model may also be extended to multithreaded applications based on the domain threading model to form a heterogeneous domain-decomposition model, when targeted to run on MP systems with multiple physical processors. When two domain threads are both highly optimized to rely on a specific type of execution unit, a multithreaded application should consider adding additional functional threads (or other heterogeneous domain threads that are less dependent on the same execution unit) to use available processors.

Continuing the domain threading model to decompose one finite task into finer threading granularity, while attempting to use all of the available processors is less likely to deliver optimal overall performance scaling with respect to MP and Hyper-Threading Technology. Because of the well-known Amdahl's law: as the finite amount of total task is divided between increasing number of data-domain threads, the speed-up of these parallel threads represent a smaller percentage of the total time of execution. Increasing the

degree of task-level parallelism in the workload also increases the opportunity to create additional threads based on the relevant threading models.

User/Source Coding Rule 37. (M impact, L generality) *Consider using thread affinity so that two highly-optimized data domain threads are executing on separate physical processors.*

In many situations, data domain threads can scale well with frequency and effectively use logical processors sharing execution resources within a physical processor. In selected cases where an individual thread needs a specific type of execution resource dedicated to it, consider scheduling such a pair of data-domain threads to run on different physical processors in an MP system.

Managing Heavily-Used Execution Resources

One way to measure the degree of overall resource utilization by a single thread is to use performance-monitoring events to count the clock cycles that a logical processor is executing code and compare that number to the number of instructions executed to completion. Such performance metrics are described in Appendix B and can be accessed using the Intel VTune Performance Analyzer.

An event ratio like non-halted cycles per instructions retired (non-halted CPI) and non-sleep CPI can be useful in directing code-tuning efforts. The non-sleep CPI metric can be interpreted as the inverse of the overall throughput of a physical processor package. The non-halted CPI metric can be interpreted as the inverse of the throughput of a logical processor⁹.

When a single thread is executing and all on-chip execution resources are available to it, non-halted CPI can indicate the unused execution bandwidth available in the physical processor package. If the value of a

9. Non-halted CPI can correlate to the resource utilization of an application thread, if the application thread is affinity to a fixed logical processor.

non-halted CPI is significantly higher than unity and overall on-chip execution resource utilization is low, a multithreaded application can direct tuning efforts to encompass the factors discussed earlier.

An optimized single thread with exclusive use of on-chip execution resources may exhibit a non-halted CPI in the neighborhood of unity¹⁰. Because most frequently used instructions typically decode into a single micro-op and have throughput of no more than two cycles, an optimized thread that retires one micro-op per cycle is only consuming about one third of peak retirement bandwidth. Significant portions of the issue port bandwidth are left unused. Thus, optimizing single-thread performance usually can be complementary with optimizing a multithreaded application to take advantage of the benefits of Hyper-Threading Technology.

On a processor with Hyper-Threading Technology, it is possible that an execution unit with lower throughput than one issue every two cycles may find itself in contention from two threads implemented using a data decomposition threading model. In one scenario, this can happen when the inner loop of both threads rely on executing a low-throughput instruction, such as `fdiv`, and the execution time of the inner loop is bound by the throughput of `fdiv`.

Using a function decomposition threading model, a multithreaded application can pair up a thread with critical dependence on a low-throughput resource with other threads that do not have the same dependency.

User/Source Coding Rule 38. (M impact, L generality) *If a single thread consumes half of the peak bandwidth of a specific execution unit (e.g. `fdiv`), consider adding a thread that seldom or rarely relies on that execution unit, when tuning for Hyper-Threading Technology.*

10. In current implementations of processors based on Intel NetBurst microarchitecture, the theoretical lower bound for either non-halted CPI or non-sleep CPI is 1/3. Practical applications rarely achieve any value close to the lower bound.

To ensure execution resources are shared cooperatively and efficiently between two logical processors, it is important to reduce stall conditions, especially those conditions causing the machine to flush its pipeline.

The primary indicator of a Pentium 4 processor pipeline stall condition is called Machine Clear. The metric is available from the VTune Analyzer's event sampling capability. When the machine clear condition occurs, all instructions that are in flight (at various stages of processing in the pipeline) must be resolved and then they are either retired or cancelled. While the pipeline is being cleared, no new instructions can be fed into the pipeline for execution. Before a machine clear condition is de-asserted, execution resources are idle.

Reducing the machine clear condition benefits single-thread performance because it increases the frequency scaling of each thread. The impact is even higher with Hyper-Threading Technology, because a machine clear condition caused by one thread can impact other threads executing simultaneously.

Several performance metrics can be used to detect situations that may cause a pipeline to be cleared. The primary metric is the Machine Clear Count: it indicates the total number of times a machine clear condition is asserted due to any cause. Possible causes include memory order violations and self-modifying code. Assists while executing x87 or SSE instructions have a similar effect on the processor's pipeline and should be reduced to a minimum.

Write-combining buffers are another example of execution resources shared between two logical processors. With two threads running simultaneously on a processor with Hyper-Threading Technology, the writes of both threads count toward the limit of four write-combining buffers. For example: if an inner loop that writes to three separate areas of memory per iteration is run by two threads simultaneously, the total number of cache lines written could be six. This being true, the code

would lose the benefits of write-combining. Loop-fission applied to this situation creates two loops, neither of which would be allowed to write to more than two cache lines per iteration.

Intel offers an array of application performance tools that are optimized to take advantage of the Intel architecture (IA)-based processors. This appendix introduces these tools and explains their capabilities for developing the most efficient programs without having to write assembly code.

The following performance tools are available:

- Intel C++ Compiler and Intel® Fortran Compiler

The Intel compilers generate highly optimized executable code and provide unique features such as profile-guided optimizations and high-level language support. This includes vectorization for MMX technology, the Streaming SIMD Extensions (SSE), and the Streaming SIMD Extensions 2 (SSE2).

- Enhanced Debugger

The Enhanced Debugger (EDB) enables you to debug C++, Fortran or mixed language programs. It allows you to view the XMM registers in a variety of formats corresponding to the data types supported by SSE and SSE2. These registers can also be viewed using the debugger supplied with Microsoft Visual C++* version 6.0, service pack 4 or later.

- VTune Performance Analyzer

The VTune analyzer collects, analyzes, and provides Intel architecture-specific software performance data from the system-wide view down to a specific module, function, and instruction in your code.

- Intel Performance Libraries

The Intel Performance Library family consists of a set of software libraries optimized for Intel architecture processors. The library family includes the following:

 - Intel® Math Kernel Library (MKL)
 - Intel® Integrated Performance Primitives (IPP)
- Intel Threading Tools. The Intel Threading Tools consist of the following:
 - Intel Thread Checker
 - Thread Profiler

Intel® Compilers¹

Intel C++ compilers can deliver significant application performance improvements for Microsoft Windows as well as Linux operating system environments. In Windows environment, the Intel C++ compiler is compatible with Microsoft Visual* C++ and plugs into the Microsoft Developer Studio IDE. The Intel Fortran Compiler can be run out of the Microsoft Developer Studio IDE by using the Fortran Build Tool that plugs into it. The Fortran compiler offers substantial source compatibility with Compaq* Visual Fortran. In Linux environment, the Intel Compilers are compatible with widely used Linux software development utilities.

Both compilers allow you to optimize your code by using special optimization options described in this section. There are several coding methods and optimizations, described here and other sections in this manual, targeted specifically for enabling software developers to optimize applications for the Pentium III and Intel Pentium 4 processors.

1. The compiler options shown in this section use syntax specific to the Microsoft Windows-based compiler. Equivalent options, which may have slightly different syntax, exist for the Linux-based compiler. See your compiler documentation for a complete listing and description of the various options available.

Vectorization, processor dispatch, inter-procedural optimization, and profile-guided optimization are all supported by the Intel compilers and can significantly aid the performance of an application.

The most general optimization options are `-O1` and `-O2`. Each of them enables a number of specific optimization options. In most cases, `-O2` is recommended over `-O1` because the `-O2` option enables inline expansion, which helps programs that have many function calls. The `-O2` option is on by default.

The `-O1` and `-O2` options enable specific options as follows:

- | | |
|------------------|--|
| <code>-O1</code> | Enables options <code>-Og</code> , <code>-Oi</code> , <code>-Os</code> , <code>-Oy</code> , <code>-Ob1</code> , <code>-Gf</code> , <code>-Gs</code> , and <code>-Gy</code> . However, <code>-O1</code> disables a few options that increase code size. |
| <code>-O2</code> | Enables options <code>-Og</code> , <code>-Oi</code> , <code>-Ot</code> , <code>-Oy</code> , <code>-Ob1</code> , <code>-Gf</code> , <code>-Gs</code> , and <code>-Gy</code> . Confines optimizations to the procedural level. |

The `-Od` option disables all optimizations.

All the command-line options are described in the *Intel C++ Compiler User's Guide*.

Code Optimization Options

This section describes the options used to optimize your code and improve the performance of your application.

Targeting a Processor (`-Gn`)

Use `-Gn` to target an application to run on a specific processor for maximum performance. Any of the `-Gn` suboptions you choose results in your binary being optimized for corresponding Intel architecture 32-bit processors. `-G6` is the default, and targets optimization for the Pentium II and Pentium III processors. `-G7` targets the Intel Pentium 4 processor. Code produced will run on any Intel architecture 32-bit processor, but will be optimized specifically for the targeted processor.

Automatic Processor Dispatch Support (`-Qx[extensions]` and `-Qax[extensions]`)

The `-Qx[extensions]` and `-Qax[extensions]` options provide support to generate code that is specific to processor-instruction extensions.

- `-Qx[extensions]` generates specialized code to run exclusively on the processors indicated by the extension(s).
- `-Qax[extensions]` generates code specialized to processors which support the specified extensions, but also generates generic IA-32 code. The generic code usually executes slower than the specialized version. A runtime check for the processor type is made to determine which code executes.

You can specify the same extensions for either option as follows:

- `i` Pentium II and Pentium III processors, which use the `CMOV` and `FCMOV` instructions
- `M` Pentium processor with MMX technology, Pentium II, and Pentium III processors
- `K` Streaming SIMD Extensions. Includes the `i` and `M` extensions.
- `W` Streaming SIMD Extensions 2. Includes the `i`, `M`, and `K` extensions.



CAUTION. *When you use `-Qax[extensions]` in conjunction with `-Qx[extensions]`, the extensions specified by `-Qx[extensions]` can be used unconditionally by the compiler, and the resulting program will require the processor extensions to execute properly.*

Vectorizer Switch Options

The Intel C++ and Fortran Compiler can vectorize your code using the vectorizer switch options. The options that enable the vectorizer are the `-Qx [M, K, W]` and `-Qax [M, K, W]` described above. The compiler provides a number of other vectorizer switch options that allow you to control vectorization. All vectorization switches require the `-Qx [M, K, W]` or `-Qax [M, K, W]` switch to be on. The default is off.

In addition to the `-Qx [M, K, W]` or `-Qax [M, K, W]` switches, the compiler provides the following vectorization control switch options:

- | | |
|-------------------------------|--|
| <code>-Qvec_report [n]</code> | Controls the vectorizer's diagnostic levels, where <code>n</code> is either 0, 1, 2, or 3. |
| <code>-Qrestrict</code> | Enables pointer disambiguation with the <code>restrict</code> qualifier. |

Prefetching

The compilers, with the `-Qx [M, K, W]` and `-Qax [M, K, W]` switches on, insert prefetch instructions, where appropriate, for the Pentium III and Pentium 4 processors.

Loop Unrolling

The compilers automatically unroll loops with the `-Qx [M, K, W]` and `-Qax [M, K, W]` switches.

To disable loop unrolling, specify `-Qunroll0`.

Multithreading with OpenMP

Both the Intel C++ and Fortran Compilers support shared memory parallelism via OpenMP compiler directives, library functions and environment variables. OpenMP directives are activated by the compiler switch `-Qopenmp`. The available directives are described in the Compiler User's Guides available with the Intel C++ and Fortran Compilers, version 5.0 and higher. Further information about the OpenMP standard is available at <http://www.openmp.org>.

Inline Expansion of Library Functions (-O1, -O1-)

The compiler inlines a number of standard C, C++, and math library functions by default. This usually results in faster execution of your program. Sometimes, however, inline expansion of library functions can cause unexpected results. For explanation, see the *Intel® C++ Compiler User's Guide*.

Floating-point Arithmetic Precision (-Op, -Op-, -Qprec, -Qprec_div, -Qpc, -Qlong_double)

These options provide optimizations with varying degrees of precision in floating-point arithmetic.

Rounding Control Option (-Qrcd)

The compiler uses the `-Qrcd` option to improve the performance of code that requires floating-point calculations. The optimization is obtained by controlling the change of the rounding mode.

The `-Qrcd` option disables the change to truncation of the rounding mode in floating-point-to-integer conversions.

For complete details on all of the code optimization options, refer to the *Intel C++ Compiler User's Guide*.

Interprocedural and Profile-Guided Optimizations

The following are two methods to improve the performance of your code based on its unique profile and procedural dependencies:

Interprocedural Optimization (IPO)

Use the `-Qip` option to analyze your code and apply optimizations between procedures within each source file. Use multifile IPO with `-Qipo` to enable the optimizations between procedures in separate source files.

Profile-Guided Optimization (PGO)

Creates an instrumented program from your source code and special code from the compiler. Each time this instrumented code is executed, the compiler generates a dynamic information file. When you compile a second time, the dynamic information files are merged into a summary file. Using the profile information in this file, the compiler attempts to optimize the execution of the most heavily travelled paths in the program.

Profile-guided optimization is particularly beneficial for the Pentium 4 processor. It greatly enhances the optimization decisions the compiler makes regarding instruction cache utilization and memory paging. Also, because PGO uses execution-time information to guide the optimizations, branch-prediction can be significantly enhanced by reordering branches and basic blocks to keep the most commonly used paths in the microarchitecture pipeline, as well as generating the appropriate branch-hints for the processor.

When you use PGO, consider the following guidelines:

- Minimize the changes to your program after instrumented execution and before feedback compilation. During feedback compilation, the compiler ignores dynamic information for functions modified after that information was generated.



NOTE. *The compiler issues a warning that the dynamic information corresponds to a modified function.*

- Repeat the instrumentation compilation if you make many changes to your source files after execution and before feedback compilation.

For complete details on the interprocedural and profile-guided optimizations, refer to the *Intel C++ Compiler User's Guide With Support for the Streaming SIMD Extensions 2* (Doc. number 718195-2001).

Intel® VTune™ Performance Analyzer

The Intel VTune Performance Analyzer is a powerful software-profiling tool for Microsoft Windows and Linux. The VTune analyzer helps you understand the performance characteristics of your software at all levels: the system, application, microarchitecture.

The sections that follow describe the major features of the VTune analyzer and briefly explain how to use them. For more details on these features, run the VTune analyzer and see the online help or the built in Getting Started Guide.

All these features are available for Microsoft Windows. However, sampling is the only profiling tool currently available on Linux.

Sampling

Sampling allows you to profile all active software on your system, including operating system, device driver, and application software. It works by occasionally interrupting the processor and collecting the instruction address, process ID, and thread ID. After the sampling activity completes, the VTune analyzer displays the data by process, thread, software module, function, relative virtual address, or line of source. There are two methods for generating samples: Time-based sampling and Event-based sampling.

Time-based Sampling

- Time-based sampling (TBS) uses an operating system's (OS) timer to periodically interrupt the processor to collect samples. The sampling interval is user definable. TBS is useful for identifying the software on your computer that is taking the most CPU time.

Figure A-1 provides an example of a hotspots report by location.

Figure A-1 Sampling Analysis of Hotspots by Location

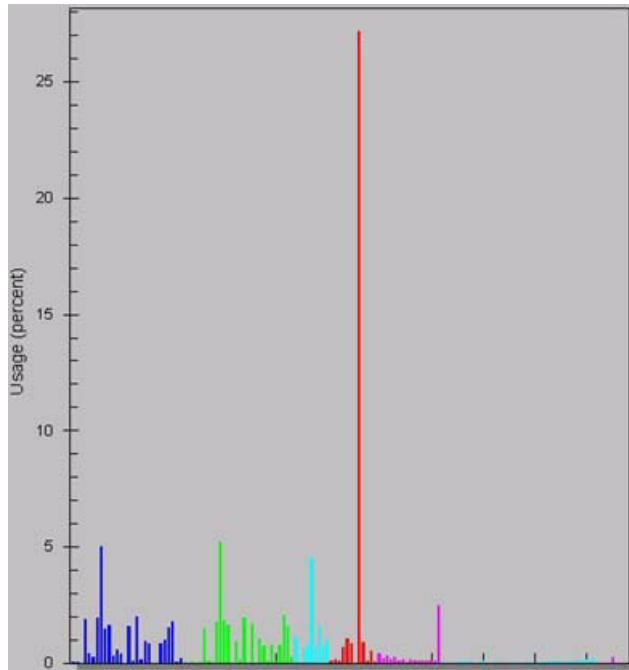

Event-based Sampling

Event-based sampling (EBS) profiles all software on your computer based on the occurrence of processor events, such as cache misses and branch mispredictions. The VTune analyzer indicates where micro architectural events, specific to the Pentium 4, Pentium III and Pentium II processors, occur the most often. On Pentium III and Pentium II processors, the VTune analyzer can collect two different events at a time. The number of the events that the VTune analyzer can collect at once on the Pentium 4 processor depends on the events selected.

Event-based samples are collected after a specific number of processor events have occurred. Like TBS, the samples can then be attributed to the different processes, threads, and software modules running on the system. You identify where the events are occurring from the system level down to the source level.

EBS can be used to provide detailed information on the behavior of the microprocessor as it executes software. Some of the events that can be sampled include clockticks, instructions retired, mispredicted branches retired, and L1 cache load misses retired. All the different events are described in the VTune analyzer's on-line help.

Call Graph

Call graph helps you understand the relationships between the functions in your application by providing timing and caller / callee (functions called) information. Call graph works by instrumenting the functions in your application. Instrumentation is the process of modifying a function so that information can be captured when the function is executed.

Instrumentation does not change the functionality of the program.

However, it can reduce performance. The VTune analyzer can detect modules as they are loaded by the operating system, and instrument them at run-time. Call graph can be used to profile Win32*, Java*, and Microsoft.NET* applications. Call graph only works for ring 3 software.

Call graph profiling provides the following information on the functions called by your application: total time, self-time, wait time, self wait time, callers, callees, and the number of calls. This data is displayed using three different views: function summary, call graph, and call list. These views are all synchronized.

The Function Summary View can be used to focus the data displayed in the call graph and call list views. This view displays all the information about the functions called by your application in a table format.

However, it does not provide callee and caller information. It just provides timing information and number of times a function is called.

The Call Graph View graphically depicts the caller / callee relationships. Each thread in the application is the root of a call tree. Each node (box) in the call tree represents a function. Each edge (line with an arrow) connecting two nodes represents the call from the parent to the child function. If the mouse pointer is hovered over a node, a tool tip will pop up displaying the function's timing information.

The Call List View is useful for analyzing programs with large, complex call trees. This view displays only the caller and callee information for the single function that you select in the Function Summary View. The data is displayed in a table format.

Counter Monitor

Counter monitor helps you identify system level performance hold-ups. It periodically polls software and hardware performance counters. The performance counter data can help you understand the cause-and-effect relationship between the computer's subsystems and your application. Counter monitor data can be displayed in real-time and logged to a file. You can also develop application specific performance counters using Performance DLLs (for more information see the VTune analyzer on-line help). The VTune analyzer can also correlate performance counter data with sampling data.

Intel® Tuning Assistant

The Intel Tuning Assistant can generate tuning advice based on counter monitor and sampling data. It can also analyze C, C++, Fortran, Java*, and assembly source code, and generate source level optimization advice. You can invoke the Intel Tuning Assistant from the source, counter monitor, or sampling views by clicking on the Intel Tuning Assistant icon.

When analyzing source code, the Intel Tuning Assistant examines the entire block of code or function you select and searches for optimization opportunities. Typically, a compiler is restricted by pointer semantics

when optimizing code. The Intel Tuning Assistant can suggest source-level modifications to overcome these and other restrictions. It also recognizes commonly used code patterns in your code and suggests how they can be modified to improve performance. You can double-click on any advice in the Intel Tuning Assistant window to display context-sensitive help with examples of the original and optimized code.

Intel Performance Libraries

The Intel Performance Library family contains a variety of specialized libraries which has been optimized for performance on Intel processors. These optimizations take advantage of appropriate architectural features, including MMX technology, Streaming SIMD Extensions (SSE) and Streaming SIMD Extensions 2 (SSE2). The library set includes:

- The Intel Math Kernel Library (Intel MKL) is composed of highly optimized mathematical functions for engineering, scientific and financial applications requiring high performance on Intel platforms. The functional areas of the library include linear algebra consisting of LAPACK and BLAS, Fast Fourier Transforms (FFT) and vector transcendental functions (vector math library/VML). Intel MKL is optimized for the latest features and capabilities of the Intel Pentium 4 processor, Intel Xeon processors and Intel® Itanium® architecture.
- Intel® Integrated Performance Primitives (IPP) is a cross-platform software library which provides a range of library functions for multimedia, audio codecs, video codecs (for example H.263, MPEG-4), image processing (JPEG), signal processing, speech compression (that is, G.723.1) plus computer vision as well as math support routines for such processing capabilities. Intel IPP is optimized for the broad range of Intel microprocessors: Intel Pentium 4 processor, the Intel Itanium architecture, Intel Xeon processors, Intel® SA-1110 and Intel® PCA application processors

based on the Intel® XScale™ microarchitecture. With a single API across the range of platforms, the users can have platform compatibility and reduced cost of development.

Benefits Summary

The overall benefits the libraries provide to the application developers are as follows:

- Low-level building block functions that support rapid application development, improving time to market
- Highly-optimized routines with a C interface that give Assembly-level performance in a C/C++ development environment (MKL also supports a Fortran interface)
- Processor-specific optimizations that yield the best performance for each Intel processor
- Processor detection and DLL dispatching that loads the appropriate code for the current processor
- Built-in error handling facility that improves productivity in the development cycle

The MKL and IPP libraries are optimized for all Intel architecture-based processors, including the Pentium, Pentium II, Pentium III, Pentium 4, Intel Xeon and Itanium processors. IPP is also optimized for the Intel® StrongARM* SA1110 processor.

Libraries Architecture

Intel Performance Libraries are designed for performance, productivity and ease of use. The Math Kernel Library (MKL) is designed for scientific, engineering and financial applications and supports both Fortran and C calling conventions. Its high-performance math functions include full Linear Algebra PACKage (LAPACK), Basic Linear Algebra Subprograms (BLAS) and fast Fourier transforms (FFTs) threaded to run on multiprocessor systems. No change of the code is required for

multiprocessor support. The library, including the parts which are not threaded, such as VML (the vector transcendental functions, Vector Math Library), is threadsafe. All libraries employ sophisticated memory management schemes and processor detection.

The Intel Integrated Performance Primitives (IPP) functions are light weight kernels without the predefined data structures of other libraries. They are designed for use as building blocks for efficiently constructing and optimizing more complex functions. Latest additions to IPP also include basic functions for operations on small matrices and fixed-accuracy vector arithmetic functions, as well as more sophisticated primitives for construction of audio, video and speech codecs such as MP3, MPEG-4, JPEG, G.723 and GSM-AMR. With the level of optimization provided by IPP, application developers are urged to investigate and utilize IPP to the full extent possible.

Optimizations with the Intel Performance Libraries

The Intel Performance Libraries implement a number of optimizations that are discussed throughout this manual. Examples include architecture-specific tuning such as loop unrolling, instruction pairing and scheduling; and memory management with explicit and implicit data prefetching and cache tuning.

The Libraries take advantage of the parallelism in the SIMD instructions using MMX technology, Streaming SIMD Extensions (SSE), and Streaming SIMD Extensions 2 (SSE2). These techniques improve the performance of computationally intensive algorithms and deliver hand coded performance in a high level language development environment.

For performance sensitive applications, the Intel Performance Libraries free the application developer from the time consuming task of assembly-level programming for a multitude of frequently used functions. The time required for prototyping and implementing new application features is substantially reduced and most important, the time to market is substantially improved. Finally, applications

developed with the Intel Performance Libraries benefit from new architectural features of future generations of Intel processors simply by relinking the application with upgraded versions of the libraries.

Enhanced Debugger (EDB)

The Enhanced Debugger (EDB) enables you to debug C++, Fortran or mixed language programs running under Windows NT* or Windows 2000 (not Windows 98). It allows you to display in a separate window the contents of the eight registers, XMM0 through XMM7, used by the Streaming SIMD Extensions and Streaming SIMD Extensions 2. You may select one of five formats for the register fields: byte (16 bytes); word (8 words); double word (4 double words); single precision (4 single precision floating point); and double precision (2 double precision floating point). When a register is updated, the new value appears in red. The corresponding Streaming SIMD Extensions or Streaming SIMD Extensions 2 instruction can be seen in the disassembly window. For further detail on the features and use of the Enhanced Debugger, refer to the online help.

Intel® Threading Tools²

The Intel® Threading Tools consist of the The Intel Thread Checker and Thread Profiler.

Intel Thread Checker

The Intel Thread Checker locates programming errors in threaded applications. Use the Intel Thread Checker to find threading errors and reduce the amount of time you spend debugging your threaded application.

2. For additional threading resources, visit <http://www.intel.com/software/products/threadtool.htm>.

The Intel Thread Checker product is an Intel VTune Performance Analyzer plug-in data collector that executes your program and automatically locates threading errors. As your program runs, the Intel Thread Checker monitors memory accesses and other events and automatically detects situations which could cause unpredictable threading-related results. The Intel Thread Checker detects thread deadlocks, stalls, data race conditions and more.

Thread Profiler

The thread profiler is a plug-in data collector for the Intel VTune Performance Analyzer. Use it to analyze threading performance and identify parallel performance problems. The thread profiler graphically illustrates what each OpenMP thread is doing at various levels of detail using a hierarchical summary. Mountains of data are collapsed into relevant summaries, sorted to identify parallel regions or loops that require attention. Its intuitive, color-coded displays make it easy to assess your application's performance.

Intel® Software College

The Intel® Software College is a valuable resource for classes on Streaming SIMD Extensions 2 (SSE2), Threading and the IA-32 Intel Architecture. For online training on how to use the SSE2 and Hyper-Threading Technology, refer to the IA-32 Architecture Training - Online Training at <http://developer.intel.com/software/college/CourseCatalog.asp?CatID=web-based>. For key algorithms and their optimization examples for the Pentium 4 processor, refer to the application notes. You can find additional information on classroom training from the Intel Software College Web site at <http://developer.intel.com/software/college>, and general information for developers from Intel Developer Services at <http://www.intel.com/ids>.

Intel Pentium 4 Processor Performance Metrics

B

The Intel Pentium 4 processor performance metrics are a set of quantities that are useful for tuning software performance when running applications on the Pentium 4 and Intel Xeon processors. The metrics are derived from the Pentium 4 and Intel Xeon processor performance monitoring events, which are described in Chapter 15 and Appendix A of the *IA-32 Intel Architecture Software Developer's Manual*, Volume 3: "System Programming."

The descriptions of the Intel Pentium 4 processor performance metrics use terminology that are specific to the Intel NetBurst microarchitecture and to the implementation in the Pentium 4 and Intel Xeon processors. The following sections explain the terminology specific to Pentium 4 and Intel Xeon processors, usage notes that apply to counting clock cycles, and notes for using some of the performance metrics dealing with bus, memory and Hyper-Threading Technology. The performance metrics are listed in Tables B-1 through B-6.

Pentium 4 Processor-Specific Terminology

Bogus, Non-bogus, Retire

Branch mispredictions incur a large penalty on microprocessors with deep pipelines. In general, the direction of branches can be predicted with a high degree of accuracy by the front end of the Intel Pentium 4 processor, such that most computations can be performed along the predicted path while waiting for the resolution of the branch.

In the event of a misprediction, instructions and micro-ops (μ ops) that were scheduled to execute along the mispredicted path must be cancelled. These instructions and μ ops are referred to as *bogus* instructions and *bogus* μ ops. A number of Pentium 4 processor performance monitoring events, for example, `instruction_retired` and `mops_retired`, can count instructions or μ ops that are retired based on the characterization of bogus versus non-bogus.

In the event descriptions in Table B-1, the term “bogus” refers to instructions or micro-ops that must be cancelled because they are on a path taken from a mispredicted branch. The terms “retired” and “non-bogus” refer to instructions or micro-ops along the path that results in committed architectural state changes as required by the program execution. Thus instructions and μ ops are either bogus or non-bogus, but not both.

Bus Ratio

Bus Ratio is the ratio of the processor clock to the bus clock. In the Bus Utilization metric, it is the `Bus_ratio`.

Replay

In order to maximize performance for the common case, the Intel NetBurst microarchitecture sometimes aggressively schedules μ ops for execution before all the conditions for correct execution are guaranteed to be satisfied. In the event that all of these conditions are not satisfied, μ ops must be reissued. This mechanism is called replay.

Some occurrences of replays are caused by cache misses, dependence violations (for example, store forwarding problems), and unforeseen resource constraints. In normal operation, some number of replays are common and unavoidable. An excessive number of replays indicate that there is a performance problem.

Assist

When the hardware needs the assistance of microcode to deal with some event, the machine takes an *assist*. One example of such situation is an underflow condition in the input operands of a floating-point operation. The hardware must internally modify the format of the operands in order to perform the computation. Assists clear the entire machine of μ ops before they begin to accumulate, and are costly. The assist mechanism on the Pentium 4 processor is similar in principle to that on the Pentium II processors, which also have an assist event.

Tagging

Tagging is a means of marking μ ops to be counted at retirement. See Appendix A of the *IA-32 Intel Architecture Software Developer's Manual*, Volume 3: "System Programming" for the description of the tagging mechanisms. The same event can happen more than once per μ op. The tagging mechanisms allow a μ op to be tagged once during its lifetime. The retired suffix is used for metrics that increment a count once per μ op, rather than once per event. For example, a μ op may encounter a cache miss more than once during its life time, but a Misses Retired metric (for example, 1st-Level Cache Misses Retired) will increment only once for that μ op.

Counting Clocks

The count of cycles, also known as clock ticks, forms a fundamental basis for measuring how long a program takes to execute, and as part of efficiency ratios like cycles per instruction (CPI). Some processor clocks may stop "ticking" under certain circumstances:

- The processor is halted, e.g. during I/O, there may be nothing for the CPU to do while servicing a disk read request, and the processor may halt to save power. When Hyper-Threading Technology is enabled, both logical processors must be halted for performance-monitoring-related counters to be powered down.

- The processor is asleep, either as a result of being halted for a while, or as part of a power-management scheme. Note that there are different levels of sleep, and in the deeper sleep levels, the timestamp counter stops counting.

This section describes three mechanisms to count processor clock cycles for monitoring performance. They are:

- **Non-Halted Clockticks:** clocks when the specified logical processor is not halted nor in any power-saving states. These can be measured on a per-logical-processor basis, when Hyper-Threading Technology is enabled.
- **Non-Sleep Clockticks:** clocks when the physical processor is not in any of the sleep modes, nor power-saving states. These **cannot** be measured on a per-logical-processor basis
- **Timestamp Counter:** clocks when the physical processor is not in deep sleep. These **cannot** be measured on a per-logical-processor basis.

The first two metrics use performance counters, and thus can be used to cause interrupt upon overflow for sampling. They may also be useful for those cases where it is easier for a tool to read a performance counter instead of the time stamp counter. The timestamp counter is accessed via an instruction, RDTSC.

For applications with a significant amount of I/O, there may be two ratios of interest:

- **Non-halted CPI:** non-halted clockticks/instructions retired measures the CPI for the phases where the CPU was being used. This ratio can be measured on a per-logical-processor basis, when Hyper-Threading Technology is enabled.
- **Nominal CPI:** timestamp counter ticks/instructions retired measures the CPI over the entire duration of the program, including those periods the machine is halted while waiting for I/O.

The distinction between these two CPI is important for processors that support Hyper-Threading Technology. Non-halted CPI should use the “Non-Halted clockticks” performance metric as the numerator. Nominal CPI can use “Non-Sleep clockticks” in the numerator. “Non-sleep clockticks” is the same as the “clockticks” metric in previous editions of this manual.

Non-Halted Clockticks

Non-halted clockticks can be obtained by programming the appropriate ESCR and CCCR following the recipe in the general metrics category in Table B-1. Additionally, the desired T0_OS/T0_USR/T1_OS/T1_USR bits may be specified to qualify a specific logical processor and/or kernel vs. user mode.

Non-Sleep Clockticks

The performance monitoring counters can also be configured to count clocks whenever the performance monitoring hardware is not powered-down. To count “non-sleep clockticks” with a performance-monitoring counter, do the following:

- Select any one of the 18 counters.
- Select any of the possible ESCRs whose events the selected counter can count, and set its event select to anything other than `no_event`. This may not seem necessary, but the counter may be disabled in some cases if this is not done.
- Turn threshold comparison on in the CCCR by setting the compare bit to 1.
- Set the threshold to 15 and the complement to 1 in the CCCR. Since no event can ever exceed this threshold, the threshold condition is met every cycle, and hence the counter counts every cycle. Note that this overrides any qualification (e.g. by CPL) specified in the ESCR.
- Enable counting in the CCCR for that counter by setting the enable bit.

The counts produced by the Non-halted and Non-sleep metrics are equivalent in most cases if each physical package supports one logical processor and is not in any power-saving states. An operating system may execute the HLT instruction and place a physical processor in a power-saving state.

On processors that support Hyper-Threading Technology, each physical package can support two or more logical processors. Current implementation of Hyper-Threading Technology provides two logical processors for each physical processor.

While both logical processors can execute two threads simultaneously, one logical processor may be halted to allow the other logical processor to execute without sharing execution resources between two logical processors. “Non-halted clockticks” can be qualified to count the number of processor clock cycles for each logical processor whenever that logical processor is not halted (it may include some portion of the clock cycles for that logical processor to complete a transition into a halted state). A physical processor that supports Hyper-Threading Technology enters into a power-saving state if all logical processors are halted.

“Non-sleep clockticks” use is based on the filtering mechanism in the CCCR: it will continue to increment as long as one logical processor is not halted, nor is it in any power-saving states. An application may indirectly cause a processor to enter into a power-saving state via an OS service that transfers control into the operating system's idle loop. The system idle loop may place the processor into a power-saving state after an implementation-dependent period if there is no work for the processor to do.

Time Stamp Counter

The time stamp counter increments whenever the sleep pin is not asserted or when the clock signal on the system bus is active. It can be read with the RDTSC instruction. The difference in values between two reads (modulo $2^{*}64$) gives the number of processor clocks between those reads.

The time stamp counter and “Non-sleep clockticks” counts should agree in practically all cases if the physical processor is not in any power-saving states. However, it is possible to have both logical processors in a physical package halted, which results in most of the chip (including the performance monitoring hardware) being powered down. In this situation, it is possible for the time stamp counter to continue incrementing because the clock signal on the system bus is still active, but “non-sleep clockticks” will no longer increment because the performance monitoring hardware is powered down in power-saving states.

Microarchitecture Notes

Trace Cache Events

The trace cache is not directly comparable to an instruction cache. The two are organized very differently. For example, a trace can span many lines' worth of instruction-cache data. As with most micro-architectural elements, trace cache performance is only an issue if something else is not a bigger bottleneck. If an application is bus bandwidth bound, the bandwidth that the front end is getting uops to the core may be irrelevant. When front-end bandwidth is an issue, the trace cache, in deliver mode, can issue uops to the core faster than either the decoder (build mode) or the microcode store (the MS ROM). Thus the percent of time in trace cache deliver mode, or similarly, the percentage of all bogus and non-bogus uops from the trace cache can be a useful metric for determining front-end performance.

The metric that is most analogous to an instruction cache miss is a trace cache miss. An unsuccessful lookup of the trace cache (colloquially, a miss) is not interesting, per se, if we are in build mode and don't find a trace available; we just keep building traces. The only "penalty" in that case is that we continue to have a lower front-end bandwidth. The trace cache miss metric that is currently used is not just any TC miss, but rather one that is incurred while the machine is already in deliver mode; i.e., when a 15-20 cycle penalty is paid. Again, care must be exercised: a small average number of TC misses per instruction does not indicate good front-end performance if the percentage of time in deliver mode is also low.

Bus and Memory Metrics

In order to correctly interpret the observed counts of performance metrics related to bus events, it is helpful to understand transaction sizes, when entries are allocated in different queues, and how sectoring and prefetching affect counts.

There is a simplified block diagram below of the sub-systems connected to the IOQ unit in the front side bus sub-system and the BSQ unit that interface to the IOQ. A two-way SMP configuration is illustrated. 1st-level cache misses and writebacks (also called core references) result in references to the 2nd-level cache. The Bus Sequence Queue (BSQ) holds requests from the processor core or prefetcher that are to be serviced on the front side bus (FSB), or in the local XAPIC. If a 3rd-level cache is present on-die, the BSQ also holds writeback requests (dirty, evicted data) from the 2nd-level cache. The FSB's IOQ holds requests that have gone out onto the front side bus.

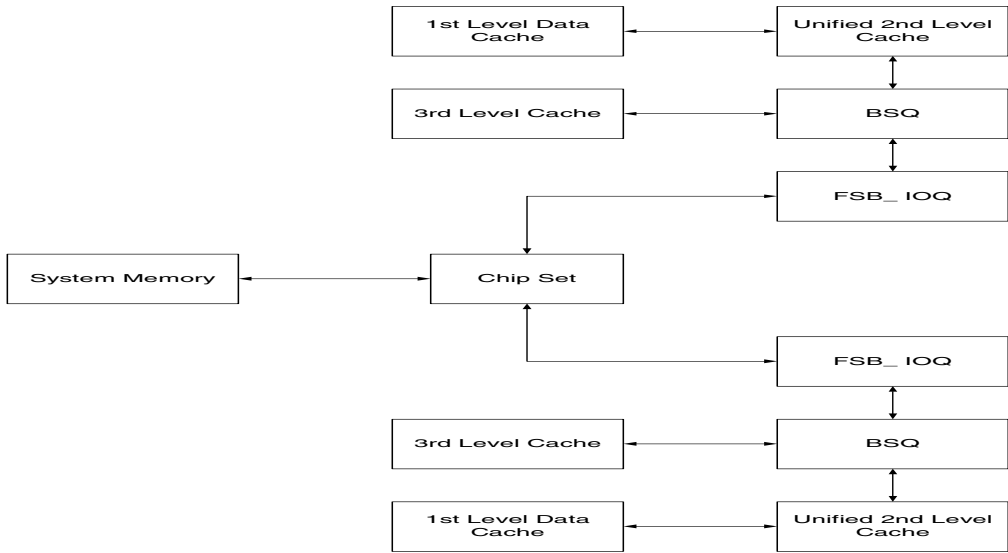
Figure B-1 Relationships Between the Cache Hierarchy, IOQ, BSQ and Front Side Bus

Core references are nominally 64 bytes, the size of a 1st-level cache line. Smaller sizes are called partials, e.g., uncacheable and write combining reads, uncacheable, write-through and write-protect writes, and all I/O. Writeback locks, streaming stores and write combining stores may be full line or partials. Partial references are not relevant for cache references, since they are associated with non-cached data. Likewise, writebacks (due to the eviction of dirty data) and RFOs (reads for ownership due to program stores) are not relevant for non-cached data.

The granularity at which the core references are counted by different bus and memory metrics listed in Table B-1 varies, depending on the underlying performance-monitoring events that these bus and memory metrics are derived from. The granularities of core references are listed below, according to the performance monitoring events that are documented in Appendix A of the *IA-32 Intel Architecture Software Developer's Manual*, Volume 3: "System Programming".

Reads due to program loads

- BSQ_cache_reference: 128 bytes for misses (on current implementations), 64 bytes for hits
- BSQ_allocation: 128 bytes for hits or misses (on current implementations), smaller for partials' hits or misses
- BSQ_active_entries: 64 bytes for hits or misses, smaller for partials' hits or misses
- IOQ_allocation, IOQ_active_entries: 64 bytes, smaller for partials' hits or misses.

Reads due to program writes (RFOs)

- BSQ_cache_reference: 64 bytes for hits or misses
- BSQ_allocation: 64 bytes for hits or misses (the granularity for misses may change in future implementations of BSQ_allocation), smaller for partials' hits or misses
- BSQ_active_entries: 64 bytes for hits or misses, smaller for partials' hits or misses
- IOQ_allocation, IOQ_active_entries: 64 bytes for hits or misses, smaller for partials' hits or misses.

Writebacks (dirty evictions)

- BSQ_cache_reference: 64 bytes
- BSQ_allocation: 64 bytes
- BSQ_active_entries: 64 bytes
- IOQ_allocation, IOQ_active_entries: 64 bytes.

The count of IOQ allocations may exceed the count of corresponding BSQ allocations on current implementations for several reasons, including:

- **Partials:**

In the FSB IOQ, any transaction smaller than 64 bytes is broken up into one to eight partials, each being counted separately as a or one to eight-byte chunks. In the BSQ, allocations of partials get a count of one. Future implementations will count each partial individually.

- **Different transaction sizes:**

The allocations of non-partial programmatic load requests get a count of one per 128 bytes in the BSQ on current implementations, and a count of one per 64 bytes in the FSB IOQ. The allocations of RFOs get a count of 1 per 64 bytes for earlier processors and for the FSB IOQ (This granularity may change in future implementations).

- **Retries:**

If the chipset requests a retry, the FSB IOQ allocations get one count per retry.

There are two noteworthy cases where there may be BSQ allocations without FSB IOQ allocations. The first is UC reads and writes to the local XAPIC registers. Second, if a cache line is evicted from the 2nd-level cache but it hits in the on-die 3rd-level cache, then a BSQ entry is allocated but no FSB transaction is necessary, and there will be no allocation in the FSB IOQ. The difference in the number of write transactions of the writeback (WB) memory type for the FSB IOQ and the BSQ can be an indication of how often this happens. It is less likely to occur for applications with poor locality of writes to the 3rd-level cache, and of course cannot happen when no 3rd-level cache is present.

Usage Notes for Specific Metrics

The difference between the metrics “Read from the processor” and “Reads non-prefetch from the processor” is nominally the number of hardware prefetches.

The paragraphs below cover several performance metrics that are based on the Pentium 4 processor performance-monitoring event “BSQ_cache_reference”. The metrics are:

- 2nd-Level Cache Read Misses
- 2nd-Level Cache Read References
- 3rd-Level Cache Read Misses
- 3rd-Level Cache Read References
- 2nd-Level Cache Reads Hit Shared
- 2nd-Level Cache Reads Hit Modified
- 2nd-Level Cache Reads Hit Exclusive
- 3rd-Level Cache Reads Hit Shared
- 3rd-Level Cache Reads Hit Modified
- 3rd-Level Cache Reads Hit Exclusive.

These metrics based on BSQ_cache_reference may be useful as an indicator of the relative effectiveness of the 2nd-level cache, and the 3rd-level cache if present. But due to the current implementation of BSQ_cache_reference in Pentium 4 and Intel Xeon processors, they should not be used to calculate cache hit rates or cache miss rates. The following three paragraphs describe some of the issues related to BSQ_cache_reference, so that its results can be better interpreted.

Current implementations of the BSQ_cache_reference event do not distinguish between programmatic read and write misses.

Programmatic writes that miss must get the rest of the cache line and merge the new data. Such a request is called a read for ownership (RFO). To the “BSQ_cache_reference” hardware, both a programmatic read and an RFO look like a data bus read, and are counted as such. Further distinction between programmatic reads and RFOs may be provided in future implementations.

Current implementations of the BSQ_cache_reference event can suffer from perceived over- or under-counting. References are based on BSQ allocations, as described above. Consequently, read misses are

generally counted once per 128-byte line BSQ allocation (whether one or both sectors are referenced), but read and write (RFO) hits and most write (RFO) misses are counted once per 64-byte line, the size of a core reference. This makes the event counts for read misses appear to have a 2-times overcounting with respect to read and write (RFO) hits and write (RFO) misses. This granularity mismatch cannot always be corrected for, making it difficult to correlate to the number of programmatic misses and hits. If the user knows that both sectors in a 128 -byte line are always referenced soon after each other, then the number of read misses can be multiplied by two to adjust miss counts to a 64-byte granularity.

Prefetches themselves are not counted as either hits or misses, as of Pentium 4 and Intel Xeon processors with a CPUID signature of 0xf21. However, in Pentium 4 Processor implementations with a CPUID signature of 0xf07 and earlier have the problem that reads to lines that are already being prefetched are counted as hits in addition to misses, thus overcounting hits.

The number of “Reads Non-prefetch from the Processor” is a good approximation of the number of outermost cache misses due to loads or RFOs, for the writeback memory type.

Usage Notes on Bus Activities

A number of performance metrics in Table B-1 are based on IOQ_active_entries and BSQ_active entries. The next three paragraphs provide information of various bus transaction underway metrics. These metrics nominally measure the end-to-end latency of transactions entering the BSQ; i.e., the aggregate sum of the allocation-to-deallocation durations for the BSQ entries used for all individual transaction in the processor. They can be divided by the corresponding number-of-transactions metrics (i.e., those that measure allocations) to approximate an average latency per transaction. However, that approximation can be significantly higher than the number of cycles it takes to get the first chunk of data for the demand fetch (e.g., load),

because the entire transaction must be completed before deallocation. That latency includes deallocation overheads, and the time to get the other half of the 128-byte line, which is called an adjacent-sector prefetch. Since adjacent-sector prefetches have lower priority than demand fetches, there is a high probability on a heavily utilized system that the adjacent-sector prefetch will have to wait until the next bus arbitration cycle from that processor. Note also that on current implementations, the granularities at which `BSQ_allocation` and `BSQ_active_entries` count can differ, leading to a possible 2-times overcounting of latencies for non-partial programmatic loads.

Users of the bus transaction underway metrics would be best served by employing them for relative comparisons across BSQ latencies of all transactions. Users that want to do cycle-by-cycle or type-by-type analysis should be aware that this event is known to be inaccurate for “UC Reads Chunk Underway” and “Write WC partial underway” metrics. Relative changes to the average of all BSQ latencies should be viewed as an indication that overall memory performance has changed. That memory performance change may or may not be reflected in the measured FSB latencies.

Also note that for Pentium 4 and Intel Xeon Processor implementations with an integrated 3rd-level cache, BSQ entries are allocated for all 2nd-level writebacks (replaced lines), not just those that become bus accesses (i.e., are also 3rd-level misses). This can decrease the average measured BSQ latencies for workloads that frequently thrash (miss or prefetch a lot into) the 2nd-level cache but hit in the 3rd-level cache. This effect may be less of a factor for workloads that miss all on-chip caches, since all BSQ entries due to such references will become bus transactions.

Metrics Descriptions and Categories

The Performance metrics for Intel Pentium 4 and Intel Xeon processors are listed in Table B-1. These performance metrics consist of recipes to program specific Pentium 4 and Intel Xeon processor performance

monitoring events to obtain event counts that represent one of the following: number of instructions, cycles, or occurrences. Table B-1 also includes a few ratios that are derived from counts of other performance metrics.

On IA-32 processors that support Hyper-Threading Technology, the performance counters and associated model specific registers (MSRs) are extended to support Hyper-Threading Technology. A subset of the performance monitoring events allow the event counts to be qualified by logical processors. The programming interface for qualification of performance monitoring events by logical processors is documented in *IA-32 Intel Architecture Software Developer's Manual, Volume 3: "System Programming."* Other performance monitoring events produce counts that are independent of which logical processor is associated with the microarchitectural events. The qualification of the performance metrics on IA-32 processors that support Hyper-Threading Technology is listed in Table B-5 and B-6.

In Table B-1, the recipe for programming the performance metrics using performance-monitoring event is arranged as follows:

- Column 1 specifies performance metrics. This may be a single-event metric; for example, the metric Instructions Retired is based on the counts of the performance monitoring event `instr_retired`, using a specific set of event mask bits. Or it can be an expression built up from other metrics; for example, IPC is derived from two single-event metrics.
- Column 2 provides a description of the metric in column 1. Please refer to the previous section, "Pentium 4 Processor-Specific Terminology" for various terms that are specific to the Pentium 4 processor's performance monitoring capabilities.
- Column 3 specifies the performance monitoring event(s) or an algebraic expression(s) that form(s) the metric. There are several metrics that require yet another sub-event in addition to the counting event. The additional sub-event information is included in column 3 as various tags, which are described in "Performance Metrics and

Tagging Mechanisms”. For event names that appear in this column, refer to the *IA-32 Intel Architecture Software Developer’s Manual*, Volume 3: “System Programming.”

- Column 4 specifies the event mask bit that is needed to use the counting event. The addresses of various model-specific registers (MSR), the event mask bits in Event Select Control registers (ESCR), the bit fields in Counter Configuration Control registers (CCCR) are described in *IA-32 Intel Architecture Software Developer’s Manual*, Volume 3: “System Programming.”

The metrics listed in Table B-1 are grouped into several categories:

General	Operation not specific to any sub-system of the microarchitecture
Branching	Branching activities
Trace Cache and Front End	Front end activities and trace cache operation modes
Memory	Memory operation related to the cache hierarch
Bus	Activities related to Front-Side Bus (FSB)
Characterization	Operations specific to the processor core

Table B-1 Pentium 4 Processor Performance Metrics

Metric	Description	Event Name or Metric Expression	Event Mask value required
General metrics			
Non-Sleep Clockticks	The number of clockticks while a processor is not in any sleep modes.	See explanation on how to count clocks in section "Counting Clocks".	
Non-Halted Clockticks	The number of clockticks that the processor is in not halted nor in sleep.	Global_power_events	RUNNING
Instructions Retired	Non-bogus IA-32 instructions executed to completion. May count more than once for some instructions with complex uop flow and were interrupted before retirement. The count may vary depending on the microarchitectural states when counting begins.	Instr_retired	NBOGUSNTAG NBOGUSTAG
Non-Sleep CPI	Cycles per instruction for a physical processor package.	$(\text{Non-Sleep Clockticks}) / (\text{Instructions Retired})$	
Non-Halted CPI	Cycles per instruction for a logical processor.	$(\text{Non-Halted Clockticks}) / (\text{Instructions Retired})$	
μops Retired	Non-bogus μops executed to completion	uops_retired	NBOGUS
UPC	μop per cycle for a logical processor	$\mu\text{ops Retired} / \text{Non-Halted Clockticks}$	

continued

Table B-1 Pentium 4 Processor Performance Metrics (continued)

Metric	Description	Event Name or Metric Expression	Event Mask value required
Speculative Uops Retired	Number of uops retired (include both instructions executed to completion and speculatively executed in the path of branch mispredictions).	uops_retired	NBOGUS BOGUS
Branching metrics			
Branches Retired	All branch instructions executed to completion	Branch_retired	MMTM MMNM MMTP MMNP
Mispredicted Branches Retired	Mispredicted branch instructions executed to completion. This stat is often used in a per-instruction ratio.	Mispred_branch_retired	NBOGUS
Misprediction Ratio	Misprediction rate per branch	(Mispredicted Branches Retired) / (Branches Retired)	
All returns	The number of return branches	retired_branch_type	RETURN
All indirect branches	All returns and indirect calls and indirect jumps	retired_branch_type	INDIRECT
All calls	All direct and indirect calls	retired_branch_type	CALL
All conditionals	The number of branches that are conditional jumps (may overcount if the branch is from build mode or there is a machine clear near the branch)	retired_branch_type	CONDITIONAL

continued

Table B-1 Pentium 4 Processor Performance Metrics (continued)

Metric	Description	Event Name or Metric Expression	Event Mask value required
Mispredicted returns	The number of mispredicted returns including all causes.	retired_mispred_branch_type	RETURN
Mispredicted indirect branches	All Mispredicted returns and indirect calls and indirect jumps	retired_mispred_branch_type	INDIRECT
Mispredicted calls	All Mispredicted indirect calls	retired_branch_type	CALL
Mispredicted conditionals	The number of mispredicted branches that are conditional jumps	retired_mispred_branch_type	CONDITIONAL
Trace Cache (TC) and front end metrics			
Page Walk Miss ITLB	The number of page walk requests due to ITLB misses.	page_walk_type	ITMISS
ITLB Misses	The number of ITLB lookups that resulted in a miss. Page Walk Miss ITLB is less speculative than ITLB Misses and is the recommended alternative.	ITLB_reference	MISS

continued

Table B-1 Pentium 4 Processor Performance Metrics (continued)

Metric	Description	Event Name or Metric Expression	Event Mask value required
Logical Processor 0 Deliver Mode	The number of cycles that the trace and delivery engine (TDE) is delivering traces associated with logical processor 0, regardless of the operating modes of the TDE for traces associated with logical processor 1. If a physical processor supports only one logical processor, all traces are associated with logical processor 0. This is the formerly known as “Trace Cache Deliver Mode“	TC_deliver_mode	SS SB SI

continued

Table B-1 Pentium 4 Processor Performance Metrics (continued)

Metric	Description	Event Name or Metric Expression	Event Mask value required
Logical Processor 1 Deliver Mode	The number of cycles that the trace and delivery engine (TDE) is delivering traces associated with logical processor 1, regardless of the operating modes of the TDE for traces associated with logical processor 0. This metric is applicable only if a physical processor supports Hyper-Threading Technology and have two logical processors per package.	TC_deliver_mode	SS BS IS
% Logical Processor N In Deliver Mode	Fraction of all non-halted cycles that the trace cache is delivering μ ops associated with a given logical processor.	(Logical Processor N Deliver Mode)*100/(Non-Halted Clockticks)	

continued

Table B-1 Pentium 4 Processor Performance Metrics (continued)

Metric	Description	Event Name or Metric Expression	Event Mask value required
Logical Processor 0 Build Mode	The number of cycles that the trace and delivery engine (TDE) is building traces associated with logical processor 0, regardless of the operating modes of the TDE for traces associated with logical processor 1. If a physical processor supports only one logical processor, all traces are associated with logical processor 0.	TC_deliver_mode	BB BS BI
Logical Processor 1 Build Mode	The number of cycles that the trace and delivery engine (TDE) is building traces associated with logical processor 1, regardless of the operating modes of the TDE for traces associated with logical processor 0. This metric is applicable only if a physical processor supports Hyper-Threading Technology and have two logical processors per package.	TC_deliver_mode	BB SB IB

continued

Table B-1 Pentium 4 Processor Performance Metrics (continued)

Metric	Description	Event Name or Metric Expression	Event Mask value required
Trace Cache Misses	The number of times that significant delays occurred in order to decode instructions and build a trace because of a TC miss.	BPU_fetch_request	TCMISS
TC to ROM Transfers	Twice the number of times that the ROM microcode is accessed to decode complex IA-32 instructions instead of building/delivering traces. (Divide the count by 2 to get the number of occurrence.)	tc_ms_xfer	CISC
Speculative TC-Built Uops	The number of speculative uops originating when the TC is in build mode.	uop_queue_writes	FROM_TC_BUILD
Speculative TC-Delivered Uops	The number of speculative uops originating when the TC is in deliver mode.	uop_queue_writes	FROM_TC_DELIVER
Speculative Microcode Uops	The number of speculative uops originating from the microcode ROM (Not all uops of an instruction from the microcode ROM will be included).	uop_queue_writes	FROM_ROM

continued

Table B-1 Pentium 4 Processor Performance Metrics (continued)

Metric	Description	Event Name or Metric Expression	Event Mask value required
Memory metrics			
Page Walk DTLB All Misses	The number of page walk requests due to DTLB misses from either load or store.	page_walk_type	DTMISS
1 st -Level Cache Load Misses Retired	The number of retired μ ops that experienced 1 st -Level cache load misses. This stat is often used in a per-instruction ratio.	Replay_event; set the following replay tag: 1stL_cache_load_miss_retired	NBOGUS
2 nd -Level Cache Load Misses Retired	The number of retired load μ ops that experienced 2 nd -Level cache misses. This stat is known to undercount when loads are spaced apart.	Replay_event; set the following replay tag: 2ndL_cache_load_miss_retired	NBOGUS
DTLB Load Misses Retired	The number of retired load μ ops that experienced DTLB misses.	Replay_event; set the following replay tag: DTLB_load_miss_retired	NBOGUS
DTLB Store Misses Retired	The number of retired store μ ops that experienced DTLB misses.	Replay_event; set the following replay tag: DTLB_store_miss_retired	NBOGUS
DTLB Load and Store Misses Retired	The number of retired load or μ ops that experienced DTLB misses.	Replay_event; set the following replay tag: DTLB_all_miss_retired	NBOGUS

continued

Table B-1 Pentium 4 Processor Performance Metrics (continued)

Metric	Description	Event Name or Metric Expression	Event Mask value required
64K Aliasing Conflicts ¹	The number of 64K aliasing conflicts. A memory reference causing 64K aliasing conflict can be counted more than once in this stat. The performance penalty resulted from 64K-aliasing conflict can vary from being unnoticeable to considerable. Some implementations of the Pentium 4 processor family can incur significant penalties for loads that alias to preceding stores.	Memory_cancel	64K_CONF
Split Load Replays	The number of load references to data that spanned two cache lines.	Memory_complete	LSC
Split Loads Retired	The number of retired load μ ops that spanned two cache lines.	Replay_event; set the following replay tag: Split_load_retired.	NBOGUS
Split Store Replays	The number of store references that spans across cache line boundary.	Memory_complete	SSC
Split Stores Retired	The number of retired store μ ops that spanned two cache lines.	Replay_event; set the following replay tag: Split_store_retired.	NBOGUS

continued

Table B-1 Pentium 4 Processor Performance Metrics (continued)

Metric	Description	Event Name or Metric Expression	Event Mask value required
MOB Load Replays	The number of replayed loads related to the Memory Order Buffer (MOB). This metric counts only the case where the store-forwarding data is not an aligned subset of the stored data.	MOB_load_replay	PARTIAL_DATA, UNALGN_ADDR
2 nd -Level Cache Read Misses ²	The number of 2 nd -level cache read misses (load and RFO misses). Beware of granularity differences.	BSQ_cache_reference	RD_2ndL_MISS
2 nd -Level Cache Read References ²	The number of 2 nd -level cache read references (loads and RFOs). Beware of granularity differences.	BSQ_cache_reference	RD_2ndL_HITS, RD_2ndL_HITE, RD_2ndL_HITM, RD_2ndL_MISS
3 rd -Level Cache Read Misses ²	The number of 3 rd -level cache read misses (load and RFOs misses). Beware of granularity differences.	BSQ_cache_reference	RD_3rdL_MISS
3 rd -Level Cache Read References ²	The number of 3 rd -level cache read references (loads and RFOs). Beware of granularity differences.	BSQ_cache_reference	RD_3rdL_HITS, RD_3rdL_HITE, RD_3rdL_HITM, RD_3rdL_MISS

continued

Table B-1 Pentium 4 Processor Performance Metrics (continued)

Metric	Description	Event Name or Metric Expression	Event Mask value required
2nd-Level Cache Reads Hit Shared	The number of 2nd-level cache read references (loads and RFOs) that hit the cache line in shared state. Beware of granularity differences.	BSQ_cache_reference	RD_2ndL_HITS
2nd-Level Cache Reads Hit Modified	The number of 2nd-level cache read references (loads and RFOs) that hit the cache line in modified state. Beware of granularity differences.	BSQ_cache_reference	RD_2ndL_HITM
2nd-Level Cache Reads Hit Exclusive	The number of 2nd-level cache read references (loads and RFOs) that hit the cache line in exclusive state. Beware of granularity differences.	BSQ_cache_reference	RD_2ndL_HITE
3rd-Level Cache Reads Hit Shared	The number of 3rd-level cache read references (loads and RFOs) that hit the cache line in shared state. Beware of granularity differences.	BSQ_cache_reference	RD_3rdL_HITS

continued

Table B-1 Pentium 4 Processor Performance Metrics (continued)

Metric	Description	Event Name or Metric Expression	Event Mask value required
3rd-Level Cache Reads Hit Modified	The number of 3rd-level cache read references (loads and RFOs) that hit the cache line in modified state. Beware of granularity differences.	BSQ_cache_reference	RD_3rdL_HITM
3rd-Level Cache Reads Hit Exclusive	The number of 3rd-level cache read references (loads and RFOs) that hit the cache line in exclusive state. Beware of granularity differences.	BSQ_cache_reference	RD_3rdL_HITE
MOB Load Replays Retired	The number of retired load μ ops that experienced replays related to the MOB.	Replay_event; set the following replay tag: MOB_load_replay_retired	NBOGUS
Loads Retired	The number of retired load operations that were tagged at the front end.	Front_end_event; set the following front end tag: Memory_loads	NBOGUS
Stores Retired	The number of retired stored operations that were tagged at the front end. This stat is often used in a per-instruction ratio.	Front_end_event; set the following front end tag: Memory_stores	NBOGUS

continued

Table B-1 Pentium 4 Processor Performance Metrics (continued)

Metric	Description	Event Name or Metric Expression	Event Mask value required
All WCB Evictions	The number of times a WC buffer eviction occurred due to any causes (This can be used to distinguish 64K aliasing cases that contribute more significantly to performance penalty, e.g., stores that are 64K aliased. A high count of this metric when there is no significant contribution due to write combining buffer full condition may indicate such a situation.)	WC_buffer	WCB_EVICTS
WCB Full Evictions	The number of times a WC buffer eviction occurred when all of the WC buffers are already allocated.	WC_buffer	WCB_FULL_EVICT
Bus metrics			

continued

Table B-1 Pentium 4 Processor Performance Metrics (continued)

Metric	Description	Event Name or Metric Expression	Event Mask value required
Bus Accesses from the Processor	The number of all bus transactions that were allocated in the IO Queue from this processor. Beware of granularity issues with this event. Also Beware of different recipes in mask bits for Pentium 4 and Intel Xeon processors between CPUID model field value of 2 and model value less than 2.	IOQ_allocation	<p>1a. ReqA0, ALL_READ, ALL_WRITE, OWN, PREFETCH (CPUID model < 2);</p> <p>1b. ReqA0, ALL_READ, ALL_WRITE, MEM_WB, MEM_WT, MEM_WP, MEM_WC, MEM_UC, OWN, PREFETCH (CPUID model >= 2).</p> <p>2. Enable edge filtering⁶ in the CCCR.</p>
Non-prefetch Bus Accesses from the Processor	The number of all bus transactions that were allocated in the IO Queue from this processor excluding prefetched sectors. Beware of granularity issues with this event. Also Beware of different recipes in mask bits for Pentium 4 and Intel Xeon processors between CPUID model field value of 2 and model value less than 2.	IOQ_allocation	<p>1a. ReqA0, ALL_READ, ALL_WRITE, OWN (CPUID model < 2);</p> <p>1b. ReqA0, ALL_READ, ALL_WRITE, MEM_WB, MEM_WT, MEM_WP, MEM_WC, MEM_UC, OWN (CPUID model < 2).</p> <p>2. Enable edge filtering⁶ in the CCCR.</p>

continued

Table B-1 Pentium 4 Processor Performance Metrics (continued)

Metric	Description	Event Name or Metric Expression	Event Mask value required
Prefetch Ratio	Fraction of all bus transactions (including retires) that were for HW or SW prefetching.	(Bus Accesses – Nonprefetch Bus Accesses)/ (Bus Accesses)	
FSB Data Ready	The number of front-side bus clocks that the bus is transmitting data driven by this processor (includes full readswrites and partial readswrites and implicit writebacks).	FSB_data_activity	1. DRDY_OWN, DRDY_DRV 2. Enable edge filtering ⁶ in the CCCR.
Bus Utilization	The % of time that the bus is actually occupied	(FSB Data Ready) *Bus_ratio*100/ Non-Sleep Clockticks	
Reads from the Processor	The number of all read (includes RFOs) transactions on the bus that were allocated in IO Queue from this processor (includes prefetches). Beware of granularity issues with this event. Also Beware of different recipes in mask bits for Pentium 4 and Intel Xeon processors between CPUID model field value of 2 and model value less than 2.	IOQ_allocation	1a. ReqA0, ALL_READ, OWN, PREFETCH (CPUID model < 2); 1b. ReqA0, ALL_READ, MEM_WB, MEM_WT, MEM_WP, MEM_WC, MEM_UC, OWN, PREFETCH (CPUID model >= 2); 2. Enable edge filtering ⁶ in the CCCR.

continued

Table B-1 Pentium 4 Processor Performance Metrics (continued)

Metric	Description	Event Name or Metric Expression	Event Mask value required
Writes from the Processor	The number of all write transactions on the bus that were allocated in IO Queue from this processor (excludes RFOs). Beware of granularity issues with this event. Also Beware of different recipes in mask bits for Pentium 4 and Intel Xeon processors between CPUID model field value of 2 and model value less than 2.	IOQ_allocation	1a. ReqA0, ALL_WRITE, OWN (CPUID model < 2); 1b. ReqA0, ALL_WRITE, MEM_WB, MEM_WT, MEM_WP, MEM_WC, MEM_UC, OWN (CPUID model >= 2). 2. Enable edge filtering ⁶ in the CCCR.
Reads Non-prefetch from the Processor	The number of all read transactions (includes RFOs but excludes prefetches) on the bus that originated from this processor. Beware of granularity issues with this event. Also Beware of different recipes in mask bits for Pentium 4 and Intel Xeon processors between CPUID model field value of 2 and model value less than 2.	IOQ_allocation	1a. ReqA0, ALL_READ, OWN (CPUID model < 2); 1b. ReqA0, ALL_READ, MEM_WB, MEM_WT, MEM_WP, MEM_WC, MEM_UC, OWN (CPUID model >= 2). 2. Enable edge filtering ⁶ in the CCCR.

continued

Table B-1 Pentium 4 Processor Performance Metrics (continued)

Metric	Description	Event Name or Metric Expression	Event Mask value required
All WC from the Processor	The number of Write Combining memory transactions on the bus that originated from this processor. Beware of granularity issues with this event. Also Beware of different recipes in mask bits for Pentium 4 and Intel Xeon processors between CPUID model field value of 2 and model value less than 2.	IOQ_allocation	1a. ReqA0, MEM_WC, OWN (CPUID model < 2); 1a. ReqA0,ALL_READ, ALL_WRITE, MEM_WC, OWN (CPUID model >= 2) 2. Enable edge filtering ⁶ in the CCCR.
All UC from the Processor	The number of UC (Uncacheable) memory transactions on the bus that originated from this processor. User Note: Beware of granularity issues. e.g. a store of dqword to UC memory requires two entries in IOQ allocation. Also Beware of different recipes in mask bits for Pentium 4 and Intel Xeon processors between CPUID model field value of 2 and model value less than 2.	IOQ_allocation	1a. ReqA0, MEM_UC, OWN (CPUID model < 2); 1a. ReqA0,ALL_READ, ALL_WRITE, MEM_UC, OWN (CPUID model >= 2) 2. Enable edge filtering ⁶ in the CCCR.

continued

Table B-1 Pentium 4 Processor Performance Metrics (continued)

Metric	Description	Event Name or Metric Expression	Event Mask value required
Bus Accesses from All Agents	The number of all bus transactions that were allocated in the IO Queue by all agents. Beware of granularity issues with this event. Also Beware of different recipes in mask bits for Pentium 4 and Intel Xeon processors between CPUID model field value of 2 and model value less than 2.	IOQ_allocation	1a. ReqA0, ALL_READ, ALL_WRITE, OWN, OTHER, PREFETCH (CPUID model < 2); 1b.ReqA0, ALL_READ, ALL_WRITE, MEM_WB, MEM_WT, MEM_WP, MEM_WC, MEM_UC, OWN, OTHER, PREFETCH (CPUID model >= 2). 2. Enable edge filtering ⁶ in the CCCR.
Bus Accesses Underway from the processor ⁷	This is an accrued sum of the durations of all bus transactions by this processor. Divide by “Bus Accesses from the processor” to get bus request latency. Also Beware of different recipes in mask bits for Pentium 4 and Intel Xeon processors between CPUID model field value of 2 and model value less than 2.	IOQ_active_entries	1a. ReqA0, ALL_READ, ALL_WRITE, OWN, PREFETCH (CPUID model < 2); 1b.ReqA0, ALL_READ, ALL_WRITE, MEM_WB, MEM_WT, MEM_WP, MEM_WC, MEM_UC, OWN, PREFETCH (CPUID model >= 2).

continued

Table B-1 Pentium 4 Processor Performance Metrics (continued)

Metric	Description	Event Name or Metric Expression	Event Mask value required
Bus Reads Underway from the processor ⁷	This is an accrued sum of the durations of all read (includes RFOs) transactions by this processor. Divide by "Reads from the Processor" to get bus read request latency. Also Beware of different recipes in mask bits for Pentium 4 and Intel Xeon processors between CPUID model field value of 2 and model value less than 2.	IOQ_active_entries	1a. ReqA0, ALL_READ, OWN, PREFETCH (CPUID model < 2); 1b. ReqA0, ALL_READ, MEM_WB, MEM_WT, MEM_WP, MEM_WC, MEM_UC, OWN, PREFETCH (CPUID model >= 2);

continued

Table B-1 Pentium 4 Processor Performance Metrics (continued)

Metric	Description	Event Name or Metric Expression	Event Mask value required
Non-prefetch Reads Underway from the processor ⁷	This is an accrued sum of the durations of read (includes RFOs but excludes prefetches) transactions that originate from this processor. Divide by “Reads Non-prefetch from the processor” to get Non-prefetch read request latency. Also Beware of different recipes in mask bits for Pentium 4 and Intel Xeon processors between CPUID model field value of 2 and model value less than 2.	IOQ_active_entries	1a. ReqA0, ALL_READ, OWN (CPUID model < 2); 1b. ReqA0, ALL_READ, MEM_WB, MEM_WT, MEM_WP, MEM_WC, MEM_UC, OWN (CPUID model >= 2).
All UC Underway from the processor ⁷	This is an accrued sum of the durations of all UC transactions by this processor. Divide by “All UC from the processor” to get UC request latency. Also Beware of different recipes in mask bits for Pentium 4 and Intel Xeon processors between CPUID model field value of 2 and model value less than 2.	IOQ_active_entries	1a. ReqA0, MEM_UC, OWN (CPUID model < 2); 1a. ReqA0, ALL_READ, ALL_WRITE, MEM_UC, OWN (CPUID model >= 2)

continued

Table B-1 Pentium 4 Processor Performance Metrics (continued)

Metric	Description	Event Name or Metric Expression	Event Mask value required
All WC Underway from the processor ⁷	This is an accrued sum of the durations of all WC transactions by this processor. Divide by “All WC from the processor” to get WC request latency. Also Beware of different recipes in mask bits for Pentium 4 and Intel Xeon processors between CPUID model field value of 2 and model value less than 2.	IOQ_active_entries	1a. ReqA0, MEM_WC, OWN (CPUID model < 2); 1a. ReqA0, ALL_READ, ALL_WRITE, MEM_WC, OWN (CPUID model >= 2)
Bus Writes Underway from the processor ⁷	This is an accrued sum of the durations of all write transactions by this processor. Divide by “Writes from the Processor” to get bus write request latency. Also Beware of different recipes in mask bits for Pentium 4 and Intel Xeon processors between CPUID model field value of 2 and model value less than 2.	IOQ_active_entries	1a. ReqA0, ALL_WRITE, OWN (CPUID model < 2); 1b. ReqA0, ALL_WRITE, MEM_WB, MEM_WT, MEM_WP, MEM_WC, MEM_UC, OWN (CPUID model >= 2).

continued

Table B-1 Pentium 4 Processor Performance Metrics (continued)

Metric	Description	Event Name or Metric Expression	Event Mask value required
Bus Accesses Underway from All Agents ⁷	This is an accrued sum of the durations of entries by all agents on the bus. Divide by “Bus Accesses from All Agents” to get bus request latency. Also Beware of different recipes in mask bits for Pentium 4 and Intel Xeon processors between CUID model field value of 2 and model value less than 2.	IOQ_active_entries	1a. ReqA0, ALL_READ, ALL_WRITE, OWN, OTHER, PREFETCH (CUID model < 2); 1b.ReqA0, ALL_READ, ALL_WRITE, MEM_WB, MEM_WT, MEM_WP, MEM_WC, MEM_UC, OWN, OTHER, PREFETCH (CUID model >= 2).
Write WC Full (BSQ)	The number of write (but neither writeback nor RFO) transactions to WC-type memory.	BSQ_allocation	1. REQ_TYPE1 REQ_LEN0 REQ_LEN1 MEM_TYPE0 REQ_DEM_TYPE 2. Enable edge filtering ⁶ in the CCCR.
Write WC Partial (BSQ)	The number of partial write transactions to WC-type memory. User note: This event may undercount WC partials that originate from DWord operands.	BSQ_allocation	1. REQ_TYPE1 REQ_LEN0 MEM_TYPE0 REQ_DEM_TYPE 2. Enable edge filtering ⁶ in the CCCR.

continued

Table B-1 Pentium 4 Processor Performance Metrics (continued)

Metric	Description	Event Name or Metric Expression	Event Mask value required
Writes WB Full (BSQ)	The number of writeback (evicted from cache) transactions to WB-type memory. Note: These writebacks may not have a corresponding FSB IOQ transaction if 3rd level cache is present.	BSQ_allocation	1. REQ_TYPE0 REQ_TYPE1 REQ_LEN0 REQ_LEN1 MEM_TYPE1 MEM_TYPE2 REQ_CACHE_TYPE REQ_DEM_TYPE 2. Enable edge filtering ⁶ in the CCCR.
Reads Non-prefetch Full (BSQ)	The number of read (excludes RFOs and HWISW prefetches) transactions to WB-type memory. Beware of granularity issues with this event.	BSQ_allocation	1. REQ_LEN0 REQ_LEN1 MEM_TYPE1 MEM_TYPE2 REQ_CACHE_TYPE REQ_DEM_TYPE 2. Enable edge filtering ⁶ in the CCCR.
Reads Invalidate Full-RFO (BSQ)	The number of read invalidate (RFO) transactions to WB-type memory	BSQ_allocation	1. REQ_TYPE0 REQ_LEN0 REQ_LEN1 MEM_TYPE1 MEM_TYPE2 REQ_CACHE_TYPE REQ_ORDER_TYPE REQ_DEM_TYPE 2. Enable edge filtering ⁶ in the CCCR.

continued

Table B-1 Pentium 4 Processor Performance Metrics (continued)

Metric	Description	Event Name or Metric Expression	Event Mask value required
UC Reads Chunk (BSQ)	The number of 8-byte aligned UC read transactions. User note: Read requests associated with 16 byte operands may under-count.	BSQ_allocation	1. REQ_LEN0 REQ_ORD_TYPE REQ_DEM_TYPE 2. Enable edge filtering ⁶ in the CCCR.
UC Reads Chunk Split (BSQ)	The number of UC read transactions that span an 8-byte boundary. User note: Read requests may under-count if the data chunk straddles 64-byte boundary.	BSQ_allocation	1. REQ_LEN0 REQ_SPLIT_TYPE REQ_ORD_TYPE REQ_DEM_TYPE 2. Enable edge filtering ⁶ in the CCCR.
UC Write Partial (BSQ)	The number of UC write transactions. Beware of granularity issues between BSQ and FSB IOQ events.	BSQ_allocation	1. REQ_TYPE0 REQ_LEN0 REQ_SPLIT_TYPE REQ_ORD_TYPE REQ_DEM_TYPE 2. Enable edge filtering ⁶ in the CCCR.
IO Reads Chunk (BSQ)	The number of 8-byte aligned IO port read transactions.	BSQ_allocation	1. REQ_LEN0 REQ_ORD_TYPE REQ_IO_TYPE REQ_DEM_TYPE 2. Enable edge filtering ⁶ in the CCCR.

continued

Table B-1 Pentium 4 Processor Performance Metrics (continued)

Metric	Description	Event Name or Metric Expression	Event Mask value required
IO Writes Chunk (BSQ)	The number of IO port write transactions.	BSQ_allocation	1. REQ_TYPE0 REQ_LEN0 REQ_ORD_TYPE REQ_IO_TYPE REQ_DEM_TYPE 2. Enable edge filtering ⁶ in the CCCR.
WB Writes Full Underway (BSQ) ⁸	This is an accrued sum of the durations of writeback (evicted from cache) transactions to WB-type memory. Divide by Writes WB Full (BSQ) to estimate average request latency. User note: Beware of effects of writebacks from 2nd-level cache that are quickly satisfied from the 3rd-level cache (if present).	BSQ_active_entries	1. REQ_TYPE0 REQ_TYPE1 REQ_LEN0 REQ_LEN1 MEM_TYPE1 MEM_TYPE2 REQ_CACHE_TYPE REQ_DEM_TYPE
UC Reads Chunk Underway (BSQ) ⁸	This is an accrued sum of the durations of UC read transactions. Divide by UC Reads Chunk (BSQ) to estimate average request latency. User note: Estimated latency may be affected by undercount in allocated entries.	BSQ_active_entries	1. REQ_LEN0 REQ_ORD_TYPE REQ_DEM_TYPE 2. Enable edge filtering ⁶ in the CCCR.

continued

Table B-1 Pentium 4 Processor Performance Metrics (continued)

Metric	Description	Event Name or Metric Expression	Event Mask value required
Write WC Partial Underway (BSQ) ⁸	This is an accrued sum of the durations of partial write transactions to WC-type memory. Divide by Write WC Partial (BSQ) to estimate average request latency. User note: Allocated entries of WC partials that originate from DWord operands are not included.	BSQ_active_entries	1. REQ_TYPE1 REQ_LEN0 MEM_TYPE0 REQ_DEM_TYPER 2. Enable edge filtering ⁶ in the CCCR.
Characterization metrics			
x87 Input Assists	The number of occurrences of x87 input operands needing assistance to handle an exception condition. This stat is often used in a per-instruction ratio.	X87_assists	PREA
x87 Output Assists	The number of occurrences of x87 operations needing assistance to handle an exception condition.	X87_assists	POAO, POAU

continued

Table B-1 Pentium 4 Processor Performance Metrics (continued)

Metric	Description	Event Name or Metric Expression	Event Mask value required
SSE Input Assists	The number of occurrences of SSE/SSE2 floating-point operations needing assistance to handle an exception condition. The number of occurrences includes speculative counts.	SSE_input_assist	ALL
Packed SP Retired ³	Non-bogus packed single-precision instructions retired.	Execution_event; set this execution tag: Packed_SP_retired	NONBOGUS0
Packed DP Retired ³	Non-bogus packed double-precision instructions retired.	Execution_event; set this execution tag: Packed_DP_retired	NONBOGUS0
Scalar SP Retired ³	Non-bogus scalar single-precision instructions retired.	Execution_event; set this execution tag: Scalar_SP_retired	NONBOGUS0
Scalar DP Retired ³	Non-bogus scalar double-precision instructions retired.	Execution_event; set this execution tag: Scalar_DP_retired	NONBOGUS0
64-bit MMX Instructions Retired ³	Non-bogus 64-bit integer SIMD instruction (MMX instructions) retired.	Execution_event; set the following execution tag: 64_bit_MMX_retired	NONBOGUS0
128-bit MMX Instructions Retired ³	Non-bogus 128-bit integer SIMD instructions retired.	Execution_event; set this execution tag: 128_bit_MMX_retired	NONBOGUS0
X87 Retired ⁴	Non-bogus x87 floating-point instructions retired.	Execution_event; set this execution tag: X87_FP_retired	NONBOGUS0

continued

Table B-1 Pentium 4 Processor Performance Metrics (continued)

Metric	Description	Event Name or Metric Expression	Event Mask value required
Stalled Cycles of Store Buffer Resources (non-standard ⁵)	The duration of stalls due to lack of store buffers.	Resource_stall	SBFULL
Machine clear metrics			
Machine Clear Count	The number of cycles that the entire pipeline of the machine is cleared for all causes.	Machine_clear	CLEAR (Also Set the following CCCR bits: Compare=1; Edge=1; Threshold=0)
Memory Order Machine Clear	The number of times that the entire pipeline of the machine is cleared due to memory-ordering issues.	Machine_clear	MOCLEAR
Self-modifying Code Clear	The number of times the entire pipeline of the machine is cleared due to self-modifying code issues.	Machine_clear	SMCCLEAR

1. A memory reference causing 64K aliasing conflict can be counted more than once in this stat. The resulting performance penalty can vary from unnoticeable to considerable. Some implementations of the Pentium 4 processor family can incur significant penalties from loads that alias to preceding stores.
2. Currently, bugs in this event can cause both overcounting and undercounting by as much as a factor of 2.
3. Most MMX technology instructions, Streaming SIMD Extensions and Streaming SIMD Extensions 2 decode into a single μ op. There are some instructions that decode into several μ ops; in these limited cases, the metrics count the number of μ ops that are actually tagged.
4. Most commonly used x87 instructions (e.g., `fmul`, `fadd`, `fdiv`, `fsqrt`, `fstp`, etc.) decode into a single μ op. However, transcendental and some x87 instructions decode into several μ ops; in these limited cases, the metrics will count the number of μ ops that are actually tagged.
5. This metric may not be supported in all models of the Pentium 4 processor family.
6. Set the following CCCR bits to make edge triggered: Compare=1; Edge=1; Threshold=0
7. Must program both MSR_FSB_ESCR0 and MSR_FSB_ESCR1.
8. Must program both MSR_BSU_ESCR0 and MSR_BSU_ESCR1.

Performance Metrics and Tagging Mechanisms

A number of metrics require more tags to be specified in addition to programming a counting event; for example, the metric Split Loads Retired requires specifying a `split_load_retired` tag in addition to programming the `replay_event` to count at retirement. This section describes three sets of tags that are used in conjunction with three at-retirement counting events: `front_end_event`, `replay_event`, and `execution_event`. Please refer to Appendix A of the “*IA-32 Intel® Architecture Software Developer’s Manual, Volume 3: System Programming*” for the description of the at-retirement events.

Tags for `replay_event`

Table B-2 provides a list of the tags that are used by various metrics in Table B-1. These tags enable you to mark μ ops at earlier stage of execution and count the μ ops at retirement using the `replay_event`. These tags require at least two MSR’s (see Table B-2, column 2 and column 3) to tag the μ ops so they can be detected at retirement. Some tags require additional MSR (see Table B-2, column 4) to select the event types for these tagged μ ops. The event names referenced in column 4 are those from the Pentium 4 processor performance monitoring events.

Table B-2 Metrics That Utilize Replay Tagging Mechanism

Replay Metric Tags ¹	Bit field to set: IA32_PEBS_ENABLE	Bit field to set: MSR_PEBS_MATRIX_VERT	Additional MSR	See Event Mask Parameter for Replay_event
1stL_cache_load_miss_retired	Bit 0, BIT 24, BIT 25	Bit 0	None	NBOGUS
2ndL_cache_load_miss_retired	Bit 1, BIT 24, BIT 25	Bit 0	None	NBOGUS
				continued

Table B-2 Metrics That Utilize Replay Tagging Mechanism (continued)

DTLB_load_miss_retired	Bit 2, BIT 24, BIT 25	Bit 0	None	NBOGUS
DTLB_store_miss_retired	Bit 2, BIT 24, BIT 25	Bit 1	None	NBOGUS
DTLB_all_miss_retired	Bit 2, BIT 24, BIT 25	Bit 0, Bit 1	None	NBOGUS
MOB_load_replay_retired	Bit 9, BIT 24, BIT 25	Bit 0	Select MOB_load_replay and set the PARTIAL_DATA and UNALGN_ADDR bits	NBOGUS
Split_load_retired	Bit 10, BIT 24, BIT 25	Bit 0	Select Load_port_replay event on SAAT_CR_ESCR1 and set SPLIT_LD bit	NBOGUS
Split_store_retired	Bit 10, BIT 24, BIT 25	Bit 1	Select Store_port_replay event on SAAT_CR_ESCR0 and set SPLIT_ST bit	NBOGUS

1. Certain kinds of μ ops cannot be tagged. These include I/O operations, UC and locked accesses, returns, and far transfers.

Tags for front_end_event

Table B-3 provides a list of the tags that are used by various metrics derived from the `front_end_event`. The event names referenced in column 2 can be found from the Pentium 4 processor performance monitoring events.

Table B-3 Table 3 Metrics That Utilize the Front-end Tagging Mechanism

Front-end MetricTags ¹	Additional MSR	See Event Mask Parameter for Front_end_event
Memory_loads	Set the TAGLOADS bit in Uop_Type	NBOGUS
Memory_stores	Set the TAGSTORES bit in Uop_Type	NBOGUS

1. There may be some undercounting of front end events when there is an overflow or underflow of the floating point stack.

Tags for execution_event

Table B-4 provides a list of the tags that are used by various metrics derived from the `execution_event`. These tags require programming an upstream ESCR to select event mask with its `TagUop` and `TagValue` bit fields. The event mask for the downstream ESCR is specified in column 4. The event names referenced in column 4 can be found in the Pentium 4 processor performance monitoring events.

Table B-4 Metrics That Utilize the Execution Tagging Mechanism

Execution Metric Tags	Upstream ESCR	Tag Value in Upstream ESCR	See Event Mask Parameter for Execution_ event
Packed_SP_retired	Set the ALL bit in the event mask and the TagUop bit in the ESCR of packed_SP_uop.	1	NBOGUS0
Scalar_SP_retired	Set the ALL bit in the event mask and the TagUop bit in the ESCR of scalar_SP_uop.	1	NBOGUS0
Scalar_DP_retired	Set the ALL bit in the event mask and the TagUop bit in the ESCR of scalar_DP_uop.	1	NBOGUS0
128_bit_MMX_retired	Set the ALL bit in the event mask and the TagUop bit in the ESCR of 128_bit_MMX_uop.	1	NBOGUS0
64_bit_MMX_retired	Set the ALL bit in the event mask and the TagUop bit in the ESCR of 64_bit_MMX_uop.	1	NBOGUS0
X87_FP_retired	Set the ALL bit in the event mask and the TagUop bit in the ESCR of x87_FP_uop.	1	NBOGUS0
X87_SIMD_memory_moves_retired	Set the ALLP0 and ALLP2 bits in event mask and the TagUop bit in the ESCR of X87_SIMD_moves_uop.	1	NBOGUS0

Using Performance Metrics with Hyper-Threading Technology

On Intel Xeon processors that support Hyper-Threading Technology, the performance metrics listed in Table B-1 may be qualified to associate the counts with a specific logical processor, provided the relevant performance monitoring events supports qualification by logical processor. Within the subset of those performance metrics that support qualification by logical processors, some of them can be programmed with parallel ESCRs and CCCRs to collect separate counts for each logical processor simultaneously. For some metrics, qualification by logical processor is supported but there is not sufficient number of MSRs for simultaneous counting of the same metric on both logical processors. In both cases, it is also possible to program the relevant ESCR for a performance metric that supports qualification by logical processor to produce counts that are, typically, the sum of contributions from both logical processors.

A number of performance metrics are based on performance monitoring events that do not support qualification by logical processor. Any attempts to program the relevant ESCRs to qualify counts by logical processor will not produce different results. The results obtained in this manner should not be summed together.

The performance metrics listed in Table B-1 fall into three categories:

- Logical processor specific and supporting parallel counting
- Logical processor specific but constrained by ESCR limitations
- Logical processor independent and not supporting parallel counting.

Table B-5 lists performance metrics in the first and second category.

Table B-6 lists performance metrics in the third category.

There are four specific performance metrics related to the trace cache that are exceptions to the three categories above. They are:

- Logical Processor 0 Deliver Mode
- Logical Processor 1 Deliver Mode

- Logical Processor 0 Build Mode
- Logical Processor 0 Build Mode.

Each of these four metrics cannot be qualified by programming bit 0 to 4 in the respective ESCR. However, it is possible and useful to collect two of these four metrics simultaneously.

Table B-5 Metrics That Support Qualification by Logical Processor and Parallel Counting

General Metrics	Uops Retired
	Instructions Retired
	Non-Halted Clockticks
	Speculative Uops Retired
Branching Metrics	Branches Retired
	Mispredicted Branches Retired
	All returns
	All indirect branches
	All calls
	All conditionals
	Mispredicted returns
	Mispredicted indirect branches
	Mispredicted calls
	Mispredicted conditionals
TC and Front End Metrics	Trace Cache Misses
	ITLB Misses
	TC to ROM Transfers
	Speculative TC-Built Uops
	Speculative TC-Delivered Uops
	Speculative Microcode Uops

continued

Table B-5 Metrics That Support Qualification by Logical Processor and Parallel Counting (continued)

Memory Metrics	Split Load Replays ¹ Split Store Replays ¹ MOB Load Replays ¹ 64k Aliasing Conflicts 1st-Level Cache Load Misses Retired 2nd-Level Cache Load Misses Retired DTLB Load Misses Retired Split Loads Retired ¹ Split Stores Retired ¹ MOB Load Replays Retired Loads Retired Stores Retired DTLB Store Misses Retired DTLB Load and Store Misses Retired 2nd-Level Cache Read Misses 2nd-Level Cache Read References 3rd-Level Cache Read Misses 3rd-Level Cache Read References 2nd-Level Cache Reads Hit Shared 2nd-Level Cache Reads Hit Modified 2nd-Level Cache Reads Hit Exclusive 3rd-Level Cache Reads Hit Shared 3rd-Level Cache Reads Hit Modified 3rd-Level Cache Reads Hit Exclusive
-----------------------	---

continued

Table B-5 Metrics That Support Qualification by Logical Processor and Parallel Counting (continued)

Bus Metrics	
	Bus Accesses from the Processor ¹
	Non-prefetch Bus Accesses from the Processor ¹
	Reads from the Processor ¹
	Writes from the Processor ¹
	Reads Non-prefetch from the Processor ¹
	All WC from the Processor ¹
	All UC from the Processor ¹
	Bus Accesses from All Agents ¹
	Bus Accesses Underway from the processor ¹
	Bus Reads Underway from the processor ¹
	Non-prefetch Reads Underway from the processor ¹
	All UC Underway from the processor ¹
	All WC Underway from the processor ¹
	Bus Writes Underway from the processor ¹
	Bus Accesses Underway from All Agents ¹
	Write WC Full (BSQ) ¹
	Write WC Partial (BSQ) ¹
	Writes WB Full (BSQ) ¹
	Reads Non-prefetch Full (BSQ) ¹
	Reads Invalidate Full- RFO (BSQ) ¹
	UC Reads Chunk (BSQ) ¹
	UC Reads Chunk Split (BSQ) ¹
	UC Write Partial (BSQ) ¹
	IO Reads Chunk (BSQ) ¹
	IO Writes Chunk (BSQ) ¹
	WB Writes Full Underway (BSQ) ¹
	UC Reads Chunk Underway (BSQ) ¹
	Write WC Partial Underway(BSQ) ¹

continued

Table B-5 Metrics That Support Qualification by Logical Processor and Parallel Counting (continued)

Characterization Metrics	x87 Input Assists x87 Output Assists Machine Clear Count Memory Order Machine Clear Self-Modifying Code Clear Scalar DP Retired Scalar SP Retired Packed DP Retired Packed SP Retired 128-bit MMX Instructions Retired 64-bit MMX Instructions Retired x87 Instructions Retired Stalled Cycles of Store Buffer Resources
---------------------------------	--

¹ Parallel counting is not supported due to ESCR restrictions.

Table B-6 Metrics That Are Independent of Logical Processors

General Metrics	Non-Sleep Clockticks
TC and Front End Metrics	Page Walk Miss ITLB
Memory Metrics	Page Walk DTLB All Misses All WCB Evictions WCB Full Evictions
Bus Metrics	Bus Data Ready from the Processor
Characterization Metrics	SSE Input Assists

IA-32 Instruction Latency and Throughput

C

This appendix contains tables of the latency, throughput and execution units that are associated with IA-32 instructions. The instruction timing data varies within the IA-32 family of processors. Only data specific to the Intel Pentium 4, Intel Xeon processors and Intel Pentium M processor are provided. The relevance of instruction throughput and latency information for code tuning is discussed in Chapter 1 and Chapter 2, see “Execution Core Detail” in Chapter 1 and “Floating Point/SIMD Operands” in Chapter 2.

This appendix contains the following sections:

- “Overview” – an overview of issues related to instruction selection and scheduling.
- “Definitions” – the definitions for the primary information presented in the tables in section “Latency and Throughput.”
- “Latency and Throughput of Pentium 4 and Intel Xeon processors” – the listings of IA-32 instruction throughput, latency and execution units associated with commonly-used instruction.

Overview

The current generation of IA-32 family of processors use out-of-order execution with dynamic scheduling and buffering to tolerate poor instruction selection and scheduling that may occur in legacy code. It can reorder μ ops to cover latency delays and to avoid resource conflicts. In some cases, the microarchitecture’s ability to avoid such delays can

be enhanced by arranging IA-32 instructions. While reordering IA-32 instructions may help, the execution core determines the final schedule of μ ops.

This appendix provides information to assembly language programmers and compiler writers, to aid in selecting the sequence of instructions which minimizes dependency chain latency, and to arrange instructions in an order which assists the hardware in processing instructions efficiently while avoiding resource conflicts. The performance impact of applying the information presented in this appendix has been shown to be on the order of several percent, for applications which are not completely dominated by other performance factors, such as:

- cache miss latencies
- bus bandwidth
- I/O bandwidth

Instruction selection and scheduling matters when the compiler or assembly programmer has already addressed the performance issues discussed in Chapter 2:

- observe store forwarding restrictions
- avoid cache line and memory order buffer splits
- do not inhibit branch prediction
- minimize the use of `xchg` instructions on memory locations

While several items on the above list involve selecting the right instruction, this appendix focuses on the following issues. These are listed in an expected priority order, though which item contributes most to performance will vary by application.

- Maximize the flow of μ ops into the execution core. IA-32 instructions which consist of more than four μ ops require additional steps from microcode ROM. These instructions with longer μ op flows incur a delay in the front end and reduce the supply of μ ops to the execution core. In Pentium 4 and Intel Xeon processors, transfers to microcode ROM often reduce how efficiently μ ops can be packed into the trace cache. Where possible, it is advisable to

select instructions with four or fewer μ ops. For example, a 32-bit integer multiply with a memory operand fits in the trace cache without going to microcode, while a 16-bit integer multiply to memory does not.

- Avoid resource conflicts. Interleaving instructions so that they don't compete for the same port or execution unit can increase throughput. For example, alternating `PADDQ` and `PMULUDQ`, each have a throughput of one issue per two clock cycles. When interleaved, they can achieve an effective throughput of one instruction per cycle because they use the same port but different execution units. Selecting instructions with fast throughput also helps to preserve issue port bandwidth, hide latency and allows for higher software performance.
- Minimize the latency of dependency chains that are on the critical path. For example, an operation to shift left by two bits executes faster when encoded as two adds than when it is encoded as a shift. If latency is not an issue, the shift results in a denser byte encoding.

In addition to the general and specific rules, coding guidelines and the instruction data provided in this manual, you can take advantage of the software performance analysis and tuning toolset available at <http://developer.intel.com/software/products/index.htm>. The tools include the VTune Performance Analyzer, with its performance-monitoring capabilities.

Definitions

The IA-32 instruction performance data are listed in several tables. The tables contain the following information:

Instruction Name: The assembly mnemonic of each instruction.

Latency: The number of clock cycles that are required for the execution core to complete the execution of all of the μ ops that form a IA-32 instruction.

- Throughput:** The number of clock cycles required to wait before the issue ports are free to accept the same instruction again. For many IA-32 instructions, the throughput of an instruction can be significantly less than its latency.
- Execution units:** The names of the execution units in the execution core that are utilized to execute the μ ops for each instruction. This information is provided only for IA-32 instructions that are decoded into no more than 4 μ ops. μ ops for instructions that decode into more than 4 μ ops are supplied by microcode ROM. Note that several execution units may share the same port, such as FP_ADD, FP_MUL, or MMX_SHFT in the FP_EXECUTE cluster (see Figure 1-4).

Latency and Throughput

This section presents the latency and throughput information for the IA-32 instruction set including the Streaming SIMD Extensions 2, Streaming SIMD Extensions, MMX technology, and most of the frequently used general-purpose integer and x87 floating-point instructions.

Due to the complexity of dynamic execution and out-of-order nature of the execution core, the instruction latency data may not be sufficient to accurately predict realistic performance of actual code sequences based on adding instruction latency data.

- The instruction latency data are useful when tuning a dependency chain. However, dependency chains limit the out-of-order core's ability to execute micro-ops in parallel. The instruction throughput data are useful when tuning parallel code unencumbered by dependency chains.
- All numeric data in the tables are:
 - approximate and are subject to change in future implementations of the Intel NetBurst microarchitecture or the Pentium M processor microarchitecture.

- not meant to be used as reference numbers for comparisons of instruction-level performance benchmarks. Comparison of instruction-level performance of microprocessors that are based on different microarchitecture is a complex subject that requires additional information that is beyond the scope of this manual.

Comparisons of latency and throughput data between the Pentium 4 processor and the Pentium M processor can be misleading, because one cycle in the Pentium 4 processor is NOT equal to one cycle in the Pentium M processor. The Pentium 4 processor is designed to operate at higher clock frequencies than the Pentium M processor. Many IA-32 instructions can operate with either registers as their operands or with a combination of register/memory address as their operands. The performance of a given instruction between these two types is different.

The section that follows, “Latency and Throughput with Register Operands”, gives the latency and throughput data for the register-to-register instruction type. Section “Latency and Throughput with Memory Operands” discusses how to adjust latency and throughput specifications for the register-to-memory and memory-to-register instructions.

In some cases, the latency or throughput figures given are just one half of a clock. This occurs only for the double-speed ALUs.

Latency and Throughput with Register Operands

The IA-32 instruction latency and throughput data are presented in Table C-1 through Table C-7. The tables include the Streaming SIMD Extension 2, Streaming SIMD Extension, MMX technology and most of the commonly used IA-32 instructions. Instruction latency and throughput of the Pentium 4 processor and of the Pentium M processor are given in separate columns. Pentium 4 processor instruction timing data are shown in the columns represented by CPUID signature 0xF2n. Pentium M processor instruction timing data are shown in the columns represented by CPUID signature 0x69n.

Table C-1 Streaming SIMD Extension 2 128-bit Integer Instructions

Instruction	Latency ¹			Throughput		Execution Unit ²
	CPUID	0F2n	0x69n	0F2n	0x69n	0F2n
CVTDQ2PS ³ xmm, xmm		5		2		FP_ADD
CVTPS2DQ ³ xmm, xmm		5	3+1	2	2	FP_ADD
CVTTPS2DQ ³ xmm, xmm		5	3+1	2	2	FP_ADD
MOVD xmm, r32		6	1	2	2	MMX_MISC,MMX_SHFT
MOVD r32, xmm		10	1+1	1	2	FP_MOVE,FP_MIS C
MOVDQA xmm, xmm		6	1	1	1	FP_MOVE
MOVDQU xmm, xmm		6	1	1	1	FP_MOVE
MOVDQ2Q mm, xmm		8	1	2	1	FP_MOVE,MMX_A LU
MOVQ2DQ xmm, mm		8	1	2	1	FP_MOVE,MMX_S HFT
MOVQ xmm, xmm		2	1	2	1	MMX_SHFT
PACKSSWB/PACKSSDW/ PACKUSWB xmm, xmm		4	2+1	2	2	MMX_SHFT
PADDB/PADDW/PADDD xmm, xmm		2	1	2	1	MMX_ALU
PADDSB/PADDSW/ PADDUSB/PADDUSW xmm, xmm		2	1	2	1	MMX_ALU
PADDQ mm, mm		2	2	1	1	FP_MISC
PSUBQ mm, mm		2	2+1	1	2	FP_MISC
PADDQ/ PSUBQ ³ xmm, xmm		6	2+1	2	2	FP_MISC
PAND xmm, xmm		2	1	2	1	MMX_ALU
PANDN xmm, xmm		2	1	2	1	MMX_ALU
PAVGB/PAVGW xmm, xmm		2		2		MMX_ALU
PCMPEQB/PCMPEQD/ PCMPEQW xmm, xmm		2	1	2	1	MMX_ALU

continued

Table C-1 Streaming SIMD Extension 2 128-bit Integer Instructions (continued)

Instruction	Latency ¹		Throughput		Execution Unit ²
PCMPGTB/PCMPGTD/PCMPGTW xmm, xmm	2	1	2	1	MMX_ALU
PEXTRW r32, xmm, imm8	7	3	2	2	MMX_SHFT,FP_MISC
PINSRW xmm, r32, imm8	4	1+1	2	2	MMX_SHFT,MMX_MISC
PMADDWD xmm, xmm	8	3+1	2	2	FP_MUL
PMAX xmm, xmm	2		2		MMX_ALU
PMIN xmm, xmm	2		2		MMX_ALU
PMOVMSKB ³ r32, xmm	7		2		FP_MISC
PMULHUW/PMULHW/PMULLW ³ xmm, xmm	8	3+1	2	2	FP_MUL
PMULUDQ mm, mm	8	6	1	2	FP_MUL
PMULUDQ xmm, xmm	8	6+2	2	4	FP_MUL
POR xmm, xmm	2	1	2	1	MMX_ALU
PSADBW xmm, xmm	4	5+2	2	4	MMX_ALU
PSHUFD xmm, xmm, imm8	4	2+1	2	2	MMX_SHFT
PSHUFW xmm, xmm, imm8	2	1	2	1	MMX_SHFT
PSHUFLW xmm, xmm, imm8	2	1	2	1	MMX_SHFT
PSLLDQ xmm, imm8	4	4	2	4	MMX_SHFT
PSLLW/PSLLD/PSLLQ xmm, xmm/imm8	2	1+1	2	2	MMX_SHFT
PSRAW/PSRAD xmm, xmm/imm8	2	1+1	2	2	MMX_SHFT
PSRLDQ xmm, imm8	4	4	2	4	MMX_SHFT
PSRLW/PSRLD/PSRLQ xmm, xmm/imm8	2	1+1	2	2	MMX_SHFT
PSUBB/PSUBW/PSUBD xmm, xmm	2	1	2	1	MMX_ALU
PSUBSB/PSUBSW/PSUBUSB/PSUBUSW xmm, xmm	2	1	2	1	MMX_ALU

continued

Table C-1 Streaming SIMD Extension 2 128-bit Integer Instructions (continued)

Instruction	Latency ¹		Throughput		Execution Unit ²
	CPUID	0F2n	0F2n	0x69n	
PUNPCKHBW/PUNPCKHWD/ PUNPCKHDQ xmm, xmm	4	1+1	2	2	MMX_SHFT
PUNPCKHQDQ xmm, xmm	4	1_1	2	2	MMX_SHFT
PUNPCKLBW/PUNPCKLWD/P UNPCKLDQ xmm, xmm	2	2	2	2	MMX_SHFT
PUNPCKLQDQ ³ xmm, xmm	4	1	1	1	FP_MISC
PXOR xmm, xmm	2	1	2	1	MMX_ALU

See “Table Footnotes”

Table C-2 Streaming SIMD Extension 2 Double-precision Floating-point Instructions

Instruction	Latency ¹		Throughput		Execution Unit ²
	CPUID	0F2n	0F2n	0x69n	
ADDPD xmm, xmm	4	4	2	2	FP_ADD
ADDSD xmm, xmm	4	3	2	1	FP_ADD
ANDNPD ³ xmm, xmm	4	1	2	1	MMX_ALU
ANDPD ³ xmm, xmm	4	1	2	1	MMX_ALU
CMPPD xmm, xmm, imm8	4	4	2	2	FP_ADD
CMPSD xmm, xmm, imm8	4	3	2	1	FP_ADD
COMISD xmm, xmm	6	1	2	1	FP_ADD, FP_MISC
CVTDQ2PD xmm, xmm	8	4+1	3	4	FP_ADD, MMX_SHFT
CVTPD2PI mm, xmm	11	5	3	3	FP_ADD, MMX_SHFT,MMX_ALU
CVTPD2DQ xmm, xmm	9	5	2	3	FP_ADD, MMX_SHFT
CVTPD2PS ³ xmm, xmm	10		2		FP_ADD, MMX_SHFT
CVTPI2PD xmm, mm	11	4+1	4	4	FP_ADD, MMX_SHFT,MMX_ALU

continued

Table C-2 Streaming SIMD Extension 2 Double-precision Floating-point Instructions (continued)

Instruction	Latency ¹		Throughput		Execution Unit ²
CVTSP2PD ³ xmm, xmm	2	2+1	2	3	FP_ADD, MMX_SHFT,MMX_ALU
CVTSD2SI r32, xmm	8		2		FP_ADD, FP_MISC
CVTSD2SS ³ xmm, xmm	16	4	4	1	FP_ADD, MMX_SHFT
CVTSI2SD ³ xmm, r32	15	4	3	1	FP_ADD, MMX_SHFT, MMX_MISC
CVTSS2SD ³ xmm, xmm	8	2	2	2	
CVTTPD2PI mm, xmm	11	5	3	3	FP_ADD, MMX_SHFT,MMX_ALU
CVTTPD2DQ xmm, xmm	9		2		FP_ADD, MMX_SHFT
CVTTSD2SI r32, xmm	8		2		FP_ADD, FP_MISC
DIVPD xmm, xmm	69	32+31	69	62	FP_DIV
DIVSD xmm, xmm	38	32	38	31	FP_DIV
MAXPD xmm, xmm	4	4	2	2	FP_ADD
MAXSD xmm, xmm	4	3	2	1	FP_ADD
MINPD xmm, xmm	4	4	2	2	FP_ADD
MINSD xmm, xmm	4	3	2	1	FP_ADD
MOVAPD xmm, xmm	6		1		FP_MOVE
MOVMSKPD r32, xmm	6		2		FP_MISC
MOVSD xmm, xmm	6		2		MMX_SHFT
MOVUPD xmm, xmm	6		1		FP_MOVE
MULPD xmm, xmm	6		2		FP_MUL
MULSS xmm, xmm	6		2		FP_MUL
ORPD ³ xmm, xmm	4		2		MMX_ALU
SHUFPD ³ xmm, xmm, imm8	6		2		MMX_SHFT
SQRTPD xmm, xmm	69	58+57	69	114	FP_DIV
SQRTSD xmm, xmm	38	58	38	57	FP_DIV
SUBPD xmm, xmm	4	4	2	2	FP_ADD

continued

Table C-2 Streaming SIMD Extension 2 Double-precision Floating-point Instructions (continued)

Instruction	Latency ¹		Throughput		Execution Unit ²
	CPUID	0F2n	0F2n	0x69n	
SUBSD xmm, xmm	4	3	2	1	FP_ADD
UCOMISD xmm, xmm	6	1	2	1	FP_ADD, FP_MISC
UNPCKHPD ³ xmm, xmm	6	1	2	1	MMX_SHFT
UNPCKLPD ³ xmm, xmm	4	1	2	1	MMX_SHFT
XORPD ³ xmm, xmm	4	1	2	1	MMX_ALU

See “Table Footnotes”

Table C-3 Streaming SIMD Extension Single-precision Floating-point Instructions

Instruction	Latency ¹		Throughput		Execution Unit ²
	CPUID	0F2n	0F2n	0x69n	
ADDPS xmm, xmm	4	4	2	2	FP_ADD
ADDSS xmm, xmm	4	3	2	1	FP_ADD
ANDNPS ³ xmm, xmm	4	2	2	2	MMX_ALU
ANDPS ³ xmm, xmm	4	2	2	2	MMX_ALU
CMPPS xmm, xmm	4	4	2	2	FP_ADD
CMPSS xmm, xmm	4	3	2	1	FP_ADD
COMISS xmm, xmm	6	1	2	1	FP_ADD,FP_MISC
CVTPI2PS xmm, mm	11	3	4	1	MMX_ALU,FP_ADD,MMX_SHFT
CVTPS2PI mm, xmm	7	3	2	1	FP_ADD,MMX_ALU
CVTSI2SS ³ xmm, r32	11	4	2	2	FP_ADD,MMX_SHFT,MMX_MISC
CVTSS2SI r32, xmm	8	4	2	1	FP_ADD,FP_MISC
CVTTPS2PI mm, xmm	7	3	2	1	FP_ADD,MMX_ALU
CVTTSS2SI r32, xmm	8	4	2	1	FP_ADD,FP_MISC
DIVPS xmm, xmm	39	18+17	39	36	FP_DIV
DIVSS xmm, xmm	23		23		FP_DIV

continued

Table C-3 Streaming SIMD Extension Single-precision Floating-point Instructions (continued)

Instruction	Latency¹		Throughput		Execution Unit²
MAXPS xmm, xmm	4		2		FP_ADD
MAXSS xmm, xmm	4		2		FP_ADD
MINPS xmm, xmm	4		2		FP_ADD
MINSS xmm, xmm	4		2		FP_ADD
MOVAPS xmm, xmm	6		1		FP_MOVE
MOVHLPS ³ xmm, xmm	6		2		MMX_SHFT
MOVLHPS ³ xmm, xmm	4		2		MMX_SHFT
MOVMSKPS r32, xmm	6		2		FP_MISC
MOVSS xmm, xmm	4		2		MMX_SHFT
MOVUPS xmm, xmm	6		1		FP_MOVE
MULPS xmm, xmm	6	4+1	2	2	FP_MUL
MULSS xmm, xmm	6		2		FP_MUL
ORPS ³ xmm, xmm	4	2	2	2	MMX_ALU
RCPPS ³ xmm, xmm	6	2	4	2	MMX_MISC
RCPSS ³ xmm, xmm	6	1	2	1	MMX_MISC,MMX_SHFT
RSQRTPS ³ xmm, xmm	6	2	4	2	MMX_MISC
RSQRTSS ³ xmm, xmm	6		4	1	MMX_MISC,MMX_SHFT
SHUFPS ³ xmm, xmm, imm8	6	2	2	2	MMX_SHFT
SQRTPS xmm, xmm	39	29+28	39	58	FP_DIV
SQRTSS xmm, xmm	23	30	23	29	FP_DIV
SUBPS xmm, xmm	4	4	2	2	FP_ADD
SUBSS xmm, xmm	4	3	2	1	FP_ADD
UCOMISS xmm, xmm	6	1	2	1	FP_ADD, FP_MISC
UNPCKHPS ³ xmm, xmm	6	3	2	2	MMX_SHFT

continued

Table C-3 Streaming SIMD Extension Single-precision Floating-point Instructions (continued)

Instruction	Latency ¹		Throughput		Execution Unit ²
	CPUID	0F2n	0F2n	0x69n	
UNPCKLPS ³ xmm, xmm	4	3	2	2	MMX_SHFT
XORPS ³ xmm, xmm	4	2	2	2	MMX_ALU
FXRSTOR	150				
FXSAVE	100				

See “Table Footnotes”

Table C-4 Streaming SIMD Extension 64-bit Integer Instructions

Instruction	Latency ¹			Throughput		Execution Unit
	CPUID	0F2n	0x69n	0F2n	0x69n	
PAVGB/PAVGW mm, mm	2			1		MMX_ALU
PEXTRW r32, mm, imm8	7	2		2	1	MMX_SHFT,FP_MISC
PINSRW mm, r32, imm8	4	1		1	1	MMX_SHFT,MMX_MISC
PMAX mm, mm	2			1		MMX_ALU
PMIN mm, mm	2			1		MMX_ALU
PMOVMSKB ³ r32, mm	7	1		2	1	FP_MISC
PMULHUW ³ mm, mm	8			1		FP_MUL
PSADBW mm, mm	4	5		1	2	MMX_ALU
PSHUFW mm, mm, imm8	2	1		1	1	MMX_SHFT

See “Table Footnotes”

Table C-5 MMX Technology 64-bit Instructions

Instruction	Latency ¹			Throughput		Execution Unit ²
	CPUID	0F2n	0x69n	0F2n	0x69n	
MOVD mm, r32		2		1		MMX_ALU
MOVD ³ r32, mm		5		1		FP_MISC
MOVQ mm, mm		6		1		FP_MOV
PACKSSWB/PACKSSDW/PACKUSWB mm, mm		2		1		MMX_SHFT

continued

Table C-5 MMX Technology 64-bit Instructions (continued)

Instruction	Latency¹	Throughput	Execution Unit²
PADDB/PADDW/PADDD mm, mm	2	1	MMX_ALU
PADDSB/PADDSW /PADDUSB/PADDUSW mm, mm	2	1	MMX_ALU
PAND mm, mm	2	1	MMX_ALU
PANDN mm, mm	2	1	MMX_ALU
PCMPEQB/PCMPEQD PCMPEQW mm, mm	2	1	MMX_ALU
PCMPGTB/PCMPGTD/ PCMPGTW mm, mm	2	1	MMX_ALU
PMADDWD ³ mm, mm	8	1	FP_MUL
PMULHW/PMULLW ³ mm, mm	8	1	FP_MUL
POR mm, mm	2	1	MMX_ALU
PSLLQ/PSLLW/ PSLLD mm, mm/imm8	2	1	MMX_SHFT
PSRAW/PSRAD mm, mm/imm8	2	1	MMX_SHFT
PSRLQ/PSRLW/PSRLD mm, mm/imm8	2	1	MMX_SHFT
PSUBB/PSUBW/PSUBD mm, mm	2	1	MMX_ALU
PSUBSB/PSUBSW/PSUBUSB/PS UBUSW mm, mm	2	1	MMX_ALU
PUNPCKHBW/PUNPCKHWD/PU NPCKHDQ mm, mm	2	1	MMX_SHFT
PUNPCKLBW/PUNPCKLWD/PUN PCKLDQ mm, mm	2	1	MMX_SHFT
PXOR mm, mm	2	1	MMX_ALU
EMMS ¹	12	12	

See "Table Footnotes"

Table C-6 IA-32 x87 Floating-point Instructions

Instruction	Latency ¹			Throughput		Execution Unit ²
	CPUID	0F2n	0x69n	0F2n	0x69n	0F2n
FABS		2		1		FP_MISC
FADD		5		1		FP_ADD
FSUB		5		1		FP_ADD
FMUL		7		2		FP_MUL
FCOM		2		1		FP_MISC
FCHS		2		1		FP_MISC
FDIV Single Precision		23		23		FP_DIV
FDIV Double Precision		38		38		FP_DIV
FDIV Extended Precision		43		43		FP_DIV
FSQRT SP		23		23		FP_DIV
FSQRT DP		38		38		FP_DIV
FSQRT EP		43		43		FP_DIV
F2XM1 ⁴		90- 150		60		
FCOS ⁴		190- 240		130		
FPATAN ⁴		150- 300		140		
FPTAN ⁴		225- 250		170		
FSIN ⁴		160- 180		130		
FSINCOS ⁴		160- 220		140		
FYL2X ⁴		140- 190		85		
FYL2XP1 ⁴		140- 190		85		
FSCALE ⁴		60		7		
FRNDINT ⁴		30		11		

continued

Table C-6 IA-32 x87 Floating-point Instructions (continued)

Instruction	Latency ¹		Throughput		Execution Unit ²
	CPUID	0F2n	0F2n	0x69n	
FXCH ⁵		0	1		FP_MOVE
FLDZ ⁶		0			
FINCSTP/FDECSTP ⁶		0			

See “Table Footnotes”

Table C-7 IA-32 General Purpose Instructions

Instruction	Latency ¹		Throughput		Execution Unit ²
	CPUID	0F2n	0F2n	0x69n	
ADC/SBB reg, reg		8	3		
ADC/SBB reg, imm		6	2		ALU
ADD/SUB		0.5	0.5		ALU
AND/OR/XOR		0.5	0.5		ALU
BSWAP		7	1		ALU
CLI			26		
CMP/TEST		0.5	0.5		ALU
DEC/INC		1	0.5		ALU
IMUL r32		14	4	3	FP_MUL
IMUL imm32		14	4	3	FP_MUL
IMUL		15-18	4	5	
IDIV		56-70		23	
IN/OUT ¹		<225		40	
Jcc ⁷		Not Applic able		0.5	ALU
LOOP		8		1.5	ALU
MOV		0.5		0.5	ALU
MOVSB/MOVSX		0.5		0.5	ALU
MOVZB/MOVZX		0.5		0.5	ALU

continued

Table C-7 IA-32 General Purpose Instructions (continued)

Instruction	Latency ¹	Throughput	Execution Unit ²
NEG/NOT/NOP	0.5	0.5	ALU
POP r32	1.5	1	MEM_LOAD,ALU
PUSH	1.5	1	MEM_STORE,ALU
RCL/RCR reg, 1 ⁸	4	1	
RCL/RCR reg, 1 ⁸	4	1	
ROL/ROR	4	1	
RET	8	1	MEM_LOAD,ALU
SAHF	0.5	0.5	ALU
SAL/SAR/SHL/SHR	4	1	1
SCAS	4	1.5	ALU, MEM_LOAD
SETcc	5	1.5	ALU
continued			
STI		36	
STOSB	5	2	ALU, MEM_STORE
XCHG	1.5	1	ALU
CALL	5	1	ALU, MEM_STORE
MUL	14-18	5	
DIV	56-70	23	

See “Table Footnotes”

Table Footnotes

The following footnotes refer to all tables in this appendix.

1. Latency information for many of instructions that are complex (> 4 μ ops) are estimates based on conservative and worst-case estimates. Actual performance of these instructions by the

out-of-order core execution unit can range from somewhat faster to significantly faster than the nominal latency data shown in these tables.

2. The names of execution units apply to processor implementations of the Intel NetBurst microarchitecture only. They include: ALU, FP_EXECUTE, FPMOVE, MEM_LOAD, MEM_STORE. See Figure 1-4 for execution units and ports in the out-of-order core. Note the following:
 - The FP_EXECUTE unit is actually a cluster of execution units, roughly consisting of seven separate execution units.
 - The FP_ADD unit handles x87 and SIMD floating-point add and subtract operation.
 - The FP_MUL unit handles x87 and SIMD floating-point multiply operation.
 - The FP_DIV unit handles x87 and SIMD floating-point divide square-root operations.
 - The MMX_SHFT unit handles shift and rotate operations.
 - The MMX_ALU unit handles SIMD integer ALU operations.
 - The MMX_MISC unit handles reciprocal MMX computations and some integer operations.
 - The FP_MISC designates other execution units in port 1 that are separated from the six units listed above.
3. It may be possible to construct repetitive calls to some IA-32 instructions in code sequences to achieve latency that is one or two clock cycles faster than the more realistic number listed in this table.
4. Latency and Throughput of transcendental instructions can vary substantially in a dynamic execution environment. Only an approximate value or a range of values are given for these instructions.
5. The FXCH instruction has 0 latency in code sequences. However, it is limited to an issue rate of one instruction per clock cycle.

6. The load constant instructions, FINCSTP, and FDECSTP have 0 latency in code sequences.
7. Selection of conditional jump instructions should be based on the recommendation of section “Branch Prediction” to improve the predictability of branches. When branches are predicted successfully, the latency of jcc is effectively zero.
8. RCL/RCR with shift count of 1 are optimized. Using RCL/RCR with shift count other than 1 will be executed more slowly. This applies to the Pentium 4 and Intel Xeon processors.

Latency and Throughput with Memory Operands

The discussion of this section applies to the Intel Pentium 4 and Intel Xeon processors. Typically, instructions with a memory address as the source operand, add one more μop to the “reg, reg” instructions type listed in Table C-1 through C-7. However, the throughput in most cases remains the same because the load operation utilizes port 2 without affecting port 0 or port 1.

Many IA-32 instructions accept a memory address as either the source operand or as the destination operand. The former is commonly referred to as a load operation, while the latter a store operation.

The latency for IA-32 instructions that perform either a load or a store operation are typically longer than the latency of corresponding register-to-register type of the IA-32 instructions. This is because load or store operations require access to the cache hierarchy and, in some cases, the memory sub-system.

For the sake of simplicity, all data being requested is assumed to reside in the first level data cache (cache hit). In general, IA-32 instructions with load operations that execute in the integer ALU units require two more clock cycles than the corresponding register-to-register flavor of the same instruction. Throughput of these instructions with load operation remains the same with the register-to-register flavor of the instructions.

Floating-point, MMX technology, Streaming SIMD Extensions and Streaming SIMD Extension 2 instructions with load operations require 6 more clocks in latency than the register-only version of the instructions, but throughput remains the same.

When store operations are on the critical path, their results can generally be forwarded to a dependent load in as few as zero cycles. Thus, the latency to complete and store isn't relevant here.

Stack Alignment



This appendix details on the alignment of the stacks of data for Streaming SIMD Extensions and Streaming SIMD Extensions 2.

Stack Frames

This section describes the stack alignment conventions for both `esp`-based (normal), and `ebp`-based (debug) stack frames. A stack frame is a contiguous block of memory allocated to a function for its local memory needs. It contains space for the function's parameters, return address, local variables, register spills, parameters needing to be passed to other functions that a stack frame may call, and possibly others. It is typically delineated in memory by a stack frame pointer (`esp`) that points to the base of the frame for the function and from which all data are referenced via appropriate offsets. The convention on IA-32 is to use the `esp` register as the stack frame pointer for normal optimized code, and to use `ebp` in place of `esp` when debug information must be kept. Debuggers use the `ebp` register to find the information about the function via the stack frame.

It is important to ensure that the stack frame is aligned to a 16-byte boundary upon function entry to keep local `__m128` data, parameters, and `xmm` register spill locations aligned throughout a function invocation. The Intel C++ Compiler for Win32* Systems supports conventions presented here help to prevent memory references from incurring penalties due to misaligned data by keeping them aligned to 16-byte boundaries. In addition, this scheme supports improved

alignment for `__m64` and `double` type data by enforcing that these 64-bit data items are at least eight-byte aligned (they will now be 16-byte aligned).

For variables allocated in the stack frame, the compiler cannot guarantee the base of the variable is aligned unless it also ensures that the stack frame itself is 16-byte aligned. Previous IA-32 software conventions, as implemented in most compilers, only ensure that individual stack frames are 4-byte aligned. Therefore, a function called from a Microsoft-compiled function, for example, can only assume that the frame pointer it used is 4-byte aligned.

Earlier versions of the Intel C++ Compiler for Win32 Systems have attempted to provide 8-byte aligned stack frames by dynamically adjusting the stack frame pointer in the prologue of `main` and preserving 8-byte alignment of the functions it compiles. This technique is limited in its applicability for the following reasons:

- The `main` function must be compiled by the Intel C++ Compiler.
- There may be no functions in the call tree compiled by some other compiler (as might be the case for routines registered as callbacks).
- Support is not provided for proper alignment of parameters.

The solution to this problem is to have the function's entry point assume only 4-byte alignment. If the function has a need for 8-byte or 16-byte alignment, then code can be inserted to dynamically align the stack appropriately, resulting in one of the stack frames shown in Figure D-1.

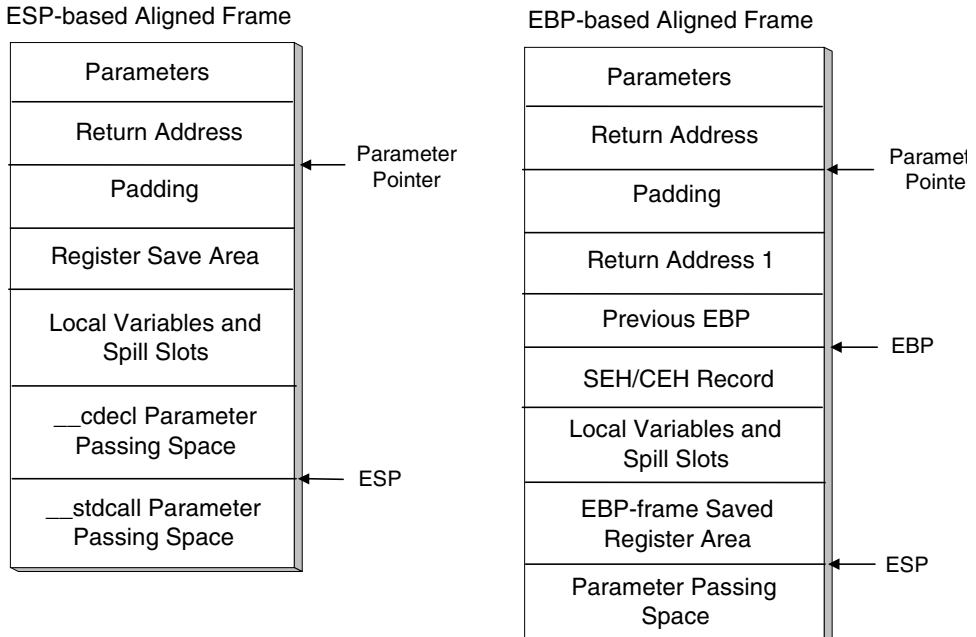
Figure D-1 Stack Frames Based on Alignment Type

As an optimization, an alternate entry point can be created that can be called when proper stack alignment is provided by the caller. Using call graph profiling of the VTune analyzer, calls to the normal (unaligned) entry point can be optimized into calls to the (alternate) aligned entry point when the stack can be proven to be properly aligned. Furthermore, a function alignment requirement attribute can be modified throughout the call graph so as to cause the least number of calls to unaligned entry points. As an example of this, suppose function F has only a stack alignment requirement of 4, but it calls function G at many call sites, and in a loop. If G's alignment requirement is 16, then by promoting F's alignment requirement to 16, and making all calls to G go to its aligned entry point, the compiler can minimize the number of times that control passes through the unaligned entry points. Example D-1 and

Example D-1 in the following sections illustrate this technique. Note the entry points `foo` and `foo.aligned`, the latter is the alternate aligned entry point.

Aligned `esp`-Based Stack Frames

This section discusses data and parameter alignment and the `declspec(align)` extended attribute, which can be used to request alignment in C and C++ code. In creating `esp`-based stack frames, the compiler adds padding between the return address and the register save area as shown in Example 3-9. This frame can be used only when debug information is not requested, there is no need for exception handling support, inlined assembly is not used, and there are no calls to `alloca` within the function.

If the above conditions are not met, an aligned `ebp`-based frame must be used. When using this type of frame, the sum of the sizes of the return address, saved registers, local variables, register spill slots, and parameter space must be a multiple of 16 bytes. This causes the base of the parameter space to be 16-byte aligned. In addition, any space reserved for passing parameters for `stdcall` functions also must be a multiple of 16 bytes. This means that the caller needs to clean up some of the stack space when the size of the parameters pushed for a call to a `stdcall` function is not a multiple of 16. If the caller does not do this, the stack pointer is not restored to its pre-call value.

In Example D-1, we have 12 bytes on the stack after the point of alignment from the caller: the return pointer, `ebx` and `edx`. Thus, we need to add four more to the stack pointer to achieve alignment. Assuming 16 bytes of stack space are needed for local variables, the compiler adds $16 + 4 = 20$ bytes to `esp`, making `esp` aligned to a 0 mod 16 address.

Example D-1 Aligned esp-Based Stack Frames

```
void _cdecl foo (int k)
{
    int j;
    foo:                                // See Note A
        push    ebx
        mov     ebx, esp
        sub     esp, 0x00000008
        and     esp, 0xffffffff0
        add     esp, 0x00000008
        jmp     common
foo.aligned:
        push    ebx
        mov     ebx, esp

common:                                // See Note B
        push    edx
        sub     esp, 20
        j = k;
        mov     edx, [ebx + 8]
        mov     [esp + 16], edx
foo(5);
        mov     [esp], 5
        call   foo.aligned
return j;
        mov     eax, [esp + 16]
        add     esp, 20
        pop    edx
        mov     esp, ebx
        pop    ebx
        ret
```



NOTE. *A. Aligned entry points assume that parameter block beginnings are aligned. This places the stack pointer at a $12 \bmod 16$ boundary, as the return pointer has been pushed. Thus, the unaligned entry point must force the stack pointer to this boundary.*

B. The code at the common label assumes the stack is at an $8 \bmod 16$ boundary, and adds sufficient space to the stack so that the stack pointer is aligned to a $0 \bmod 16$ boundary.

Aligned `ebp`-Based Stack Frames

In `ebp`-based frames, padding is also inserted immediately before the return address. However, this frame is slightly unusual in that the return address may actually reside in two different places in the stack. This occurs whenever padding must be added and exception handling is in effect for the function. Example D-2 shows the code generated for this type of frame. The stack location of the return address is aligned $12 \bmod 16$. This means that the value of `ebp` always satisfies the condition $(\text{ebp} \& 0x0f) == 0x08$. In this case, the sum of the sizes of the return address, the previous `ebp`, the exception handling record, the local variables, and the spill area must be a multiple of 16 bytes. In addition, the parameter passing space must be a multiple of 16 bytes. For a call to a `stdcall` function, it is necessary for the caller to reserve some stack space if the size of the parameter block being pushed is not a multiple of 16.

Example D-2 Aligned ebp-based Stack Frames

```
void _stdcall foo (int k)
{
    int j;
    foo:
        push    ebx
        mov     ebx, esp
        sub     esp, 0x00000008
        and     esp, 0xffffffff0
        add     esp, 0x00000008           // esp is (8 mod 16)
after add
        jmp     common
    foo.aligned:
        push    ebx                       // esp is (8 mod 16)
after push
        mov     ebx, esp
    common:
        push    ebp                       // this slot will be
used for                                 // duplicate return pt
                                           // esp is (0 mod 16)
        push    ebp                       // (rtn,ebx,ebp,ebp)
after push
                                           // fetch return pointer
        mov     ebp, [ebx + 4]
and store
        mov     [esp + 4], ebp           // relative to ebp
                                           // (rtn,ebx,rtn,ebp)
        mov     ebp, esp                 // ebp is (0 mod 16)
        sub     esp, 28                  // esp is (4 mod 16)
                                           //see Note A
        push    edx                       // esp is (0 mod 16)
after push
```

continued

Example D-2 Aligned ebp-based Stack Frames (continued)

```

// the goal is to make
esp and ebp
// (0 mod 16) here
j = k;
    mov     edx, [ebx + 8]    // k is (0 mod 16) if
caller aligned              // its stack
    mov     [ebp - 16], edx  // J is (0 mod 16)
foo(5);
    add     esp, -4          // normal call sequence
to                            // unaligned entry
    mov     [esp], 5
    call    foo              // for stdcall, callee
                                // cleans up stack
foo.aligned(5);
    add     esp, -16        // aligned entry, this
should                        // be a multiple of 16
    mov     [esp], 5
    call    foo.aligned
    add     esp, 12         // see Note B
return j;
    mov     eax, [ebp-16]
    pop     edx
    mov     esp, ebp
    pop     ebp
    mov     esp, ebx
    pop     ebx
ret 4
}
```



NOTE. A. *Here we allow for local variables. However, this value should be adjusted so that, after pushing the saved registers, esp is $0 \bmod 16$.*

B. *Just prior to the call, esp is $0 \bmod 16$. To maintain alignment, esp should be adjusted by 16. When a callee uses the `stdcall` calling sequence, the stack pointer is restored by the callee. The final addition of 12 compensates for the fact that only 4 bytes were passed, rather than 16, and thus the caller must account for the remaining adjustment.*

Stack Frame Optimizations

The Intel C++ Compiler provides certain optimizations that may improve the way aligned frames are set up and used. These optimizations are as follows:

- If a procedure is defined to leave the stack frame 16-byte-aligned and it calls another procedure that requires 16-byte alignment, then the callee's aligned entry point is called, bypassing all of the unnecessary aligning code.
- If a static function requires 16-byte alignment, and it can be proven to be called only by other functions that require 16-byte alignment, then that function will not have any alignment code in it. That is, the compiler will not use `ebx` to point to the argument block and it will not have alternate entry points, because this function will never be entered with an unaligned frame.

Inlined Assembly and `ebx`

When using aligned frames, the `ebx` register generally should not be modified in inlined assembly blocks since `ebx` is used to keep track of the argument block. Programmers may modify `ebx` only if they do not need to access the arguments and provided they save `ebx` and restore it before the end of the function (since `esp` is restored relative to `ebx` in the function's epilog).

For additional information on the use of `ebx` in inline assembly code and other related issues, see relevant application notes in the Intel Architecture Performance Training Center.



CAUTION. *Do not use the `ebx` register in inline assembly functions that use dynamic stack alignment for `double`, `__m64`, and `__m128` local variables unless you save and restore `ebx` each time you use it. The Intel C++ Compiler uses the `ebx` register to control alignment of variables of these types, so the use of `ebx`, without preserving it, will cause unexpected program execution.*

Mathematics of Prefetch Scheduling Distance



This appendix discusses how far away to insert prefetch instructions. It presents a mathematical model allowing you to deduce a simplified equation which you can use for determining the prefetch scheduling distance (PSD) for your application.

For your convenience, the first section presents this simplified equation; the second section provides the background for this equation: the mathematical model of the calculation.

Simplified Equation

A simplified equation to compute PSD is as follows:

$$psd = \left\lceil \frac{N_{lookup} + N_{xfer} \cdot (N_{pref} + N_{st})}{CPI \cdot N_{inst}} \right\rceil$$

where

- | | |
|-------------------------|--|
| psd | is prefetch scheduling distance. |
| N_{lookup} | is the number of clocks for lookup latency. This parameter is system-dependent. The type of memory used and the chipset implementation affect its value. |
| N_{xfer} | is the number of clocks to transfer a cache-line. This parameter is implementation-dependent. |
| N_{pref} and N_{st} | are the numbers of cache lines to be prefetched and stored. |
| CPI | is the number of clocks per instruction. This parameter is implementation-dependent. |

N_{inst} is the number of instructions in the scope of one loop iteration.

Consider the following example of a heuristic equation assuming that parameters have the values as indicated:

$$psd = \left\lceil \frac{60 + 25 \cdot (N_{pref} + N_{st})}{1.5 \cdot N_{inst}} \right\rceil$$

where 60 corresponds to N_{lookup} , 25 to N_{xfer} , and 1.5 to CPI .

The values of the parameters in the equation can be derived from the documentation for memory components and chipsets as well as from vendor datasheets.



CAUTION. *The values in this example are for illustration only and do not represent the actual values for these parameters. The example is provided as a “starting point approximation” of calculating the prefetch scheduling distance using the above formula. Experimenting with the instruction around the “starting point approximation” may be required to achieve the best possible performance.*

Mathematical Model for PSD

The parameters used in the mathematics discussed are as follows:

psd	prefetch scheduling distance (measured in number of iterations)
il	iteration latency
T_c	computation latency per iteration with prefetch caches
T_l	memory leadoff latency including cache miss latency, chip set latency, bus arbitration, etc.

T_b data transfer latency which is equal to number of lines per iteration * line burst latency

Note that the potential effects of μ op reordering are not factored into the estimations discussed.

Examine Example E-1 that uses the `prefetchnta` instruction with a prefetch scheduling distance of 3, that is, $psd = 3$. The data prefetched in iteration i , will actually be used in iteration $i+3$. T_c represents the cycles needed to execute `top_loop` - assuming all the memory accesses hit L1 while `il` (iteration latency) represents the cycles needed to execute this loop with actually run-time memory footprint. T_c can be determined by computing the critical path latency of the code dependency graph. This work is quite arduous without help from special performance characterization tools or compilers. A simple heuristic for estimating the T_c value is to count the number of instructions in the critical path and multiply the number with an artificial CPI. A reasonable CPI value would be somewhere between 1.0 and 1.5 depending on the quality of code scheduling.

Example E-1 Calculating Insertion for Scheduling Distance of 3



```

top_loop:
    prefetchnta [edx+esi+32*3]
    prefetchnta [edx*4+esi+32*3]
    . . . . .
    movaps xmm1, [edx+esi]
    movaps xmm2, [edx*4+esi]
    movaps xmm3, [edx+esi+16]
    movaps xmm4, [edx*4+esi+16]
    . . . . .
    . . .
    add esi, 32
    cmp esi, ecx
    jl top_loop
    
```

Memory access plays a pivotal role in prefetch scheduling. For more understanding of a memory subsystem, consider Streaming SIMD Extensions and Streaming SIMD Extensions 2 memory pipeline depicted in Figure E-1.

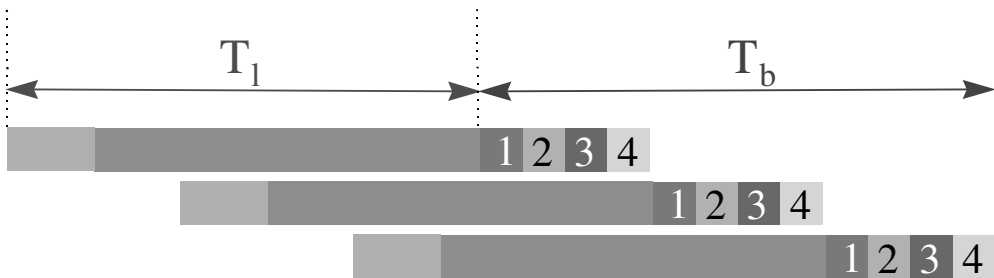
Figure E-1 Pentium II, Pentium III and Pentium 4 Processors Memory Pipeline Sketch



-  : L2 lookup miss latency
 -  : Memory page access leadoff latency
 -  : Latency for 4 chunks returned per line
-

Assume that three cache lines are accessed per iteration and four chunks of data are returned per iteration for each cache line. Also assume these 3 accesses are pipelined in memory subsystem. Based on these assumptions,

$$T_b = 3 * 4 = 12 \text{ FSB cycles.}$$

T_1 varies dynamically and is also system hardware-dependent. The static variants include the core-to-front-side-bus ratio, memory manufacturer and memory controller (chipset). The dynamic variants include the memory page open/miss occasions, memory accesses sequence, different memory types, and so on.

To determine the proper prefetch scheduling distance, follow these steps and formulae:

- Optimize T_c as much as possible
- Use the following set of formulae to calculate the proper prefetch scheduling distance:

$$\begin{array}{lll}
 T_c \geq T_l + T_b & psd = 1 & il = T_c \\
 T_l + T_b > T_c > T_b & psd = \left\lceil \frac{T_l + T_b}{T_c} \right\rceil & il = T_c \\
 T_b \geq T_c & psd = 1 + \left\lceil \frac{T_l}{T_b} \right\rceil & il = T_b
 \end{array}$$

- Schedule the prefetch instructions according to the computed prefetch scheduling distance.
- For optimized memory performance, apply techniques described in “Memory Optimization Using Prefetch” in Chapter 6.

The following sections explain and illustrate the architectural considerations involved in the prefetch scheduling distance formulae above.

No Preloading or Prefetch

The traditional programming approach does not perform data preloading or prefetch. It is sequential in nature and will experience stalls because the memory is unable to provide the data immediately when the execution pipeline requires it. Examine Figure E-2.

Figure E-2 Execution Pipeline, No Preloading or Prefetch

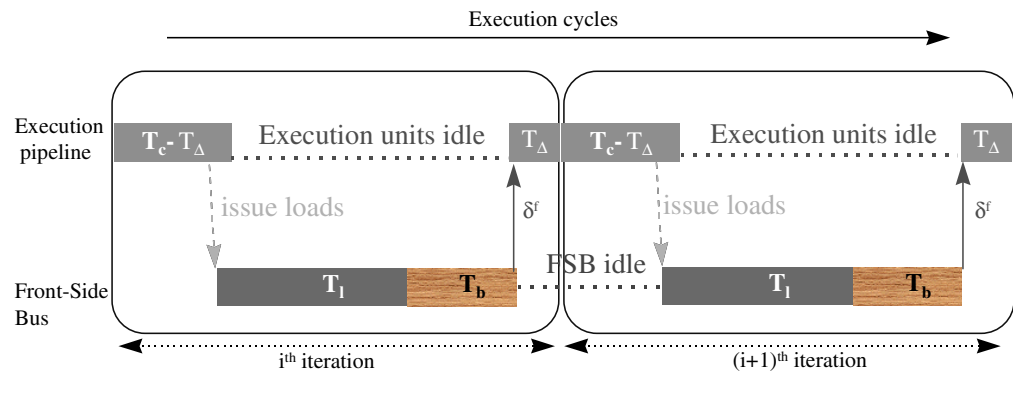

As you can see from Figure E-2, the execution pipeline is stalled while waiting for data to be returned from memory. On the other hand, the front side bus is idle during the computation portion of the loop. The memory access latencies could be hidden behind execution if data could be fetched earlier during the bus idle time.

Further analyzing Figure E-2,

- assume execution cannot continue till last chunk returned and
- δ^f indicates flow data dependency that stalls the execution pipelines

With these two things in mind the iteration latency (il) is computed as follows:

$$il \cong T_c + T_l + T_b$$

The iteration latency is approximately equal to the computation latency plus the memory leadoff latency (includes cache miss latency, chipset latency, bus arbitration, and so on.) plus the data transfer latency where transfer latency= number of lines per iteration * line burst latency.

This means that the decoupled memory and execution are ineffective to explore the parallelism because of flow dependency. That is the case where prefetch can be useful by removing the bubbles in either the execution pipeline or the memory pipeline.

With an ideal placement of the data prefetching, the iteration latency should be either bound by execution latency or memory latency, that is

$$il = \text{maximum}(T_c, T_b).$$

Compute Bound (Case: $T_c \geq T_l + T_b$)

Figure E-3 represents the case when the compute latency is greater than or equal to the memory leadoff latency plus the data transfer latency. In this case, the prefetch scheduling distance is exactly 1; i.e., prefetch data one iteration ahead is good enough. The data for loop iteration i can be prefetched during loop iteration $i-1$, the δ^f symbol between front-side bus and execution pipeline indicates the data flow dependency.

Figure E-3 Compute Bound Execution Pipeline

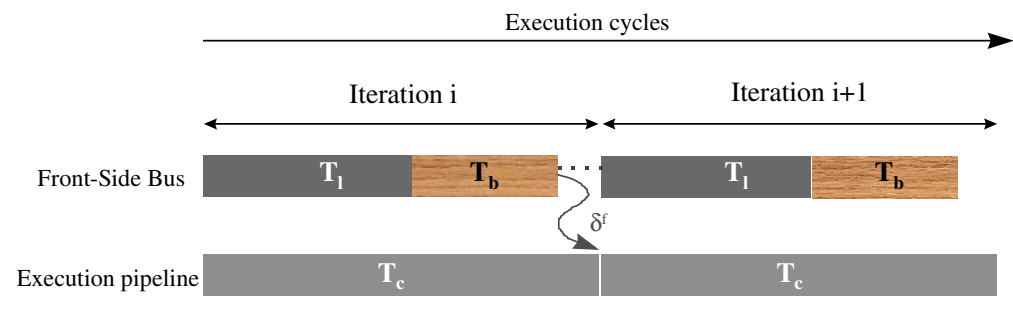

The following formula shows the relationship among the parameters:

$$psd = \left\lceil \frac{T_l + T_b}{T_c} \right\rceil \equiv 1 \quad \text{if } T_c = T_l + T_b$$

It can be seen from this relationship that the iteration latency is equal to the computation latency, which means the memory accesses are executed in background and their latencies are completely hidden.

Compute Bound (Case: $T_l + T_b > T_c > T_b$)

Now consider the next case by first examining Figure E-4.

Figure E-4 Another Compute Bound Execution Pipeline

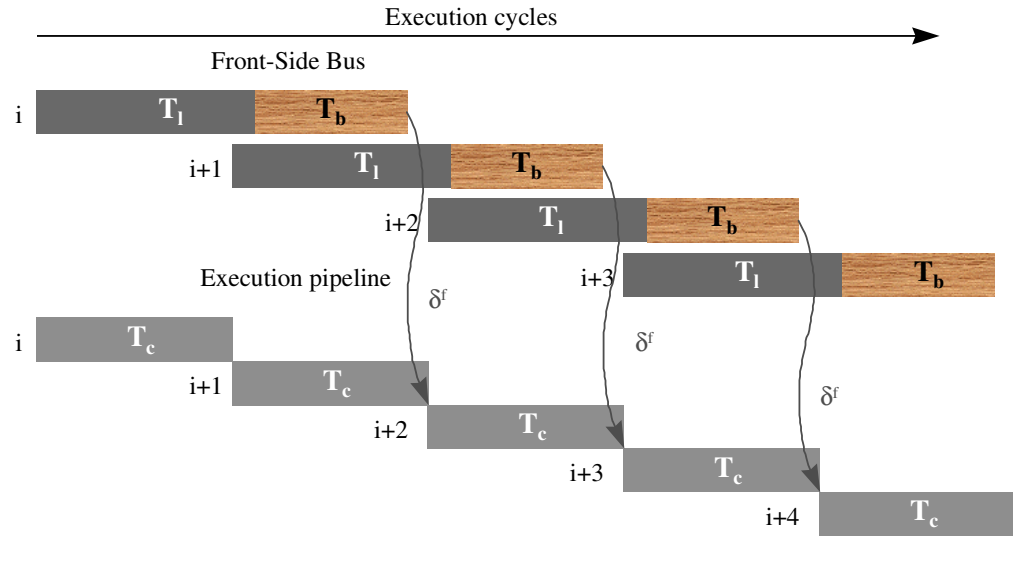

For this particular example the prefetch scheduling distance is greater than 1. Data being prefetched for iteration i will be consumed in iteration $i+2$.

Figure E-4 represents the case when the leadoff latency plus data transfer latency is greater than the compute latency, which is greater than the data transfer latency. The following relationship can be used to compute the prefetch scheduling distance.

$$psd = \left\lceil \frac{T_i + T_b}{T_c} \right\rceil > 1 \quad il = T_c$$

In consequence, the iteration latency is also equal to the computation latency, that is, compute bound program.

Memory Throughput Bound (Case: $T_b \geq T_c$)

When the application or loop is memory throughput bound, the memory latency is no way to be hidden. Under such circumstances, the burst latency is always greater than the compute latency. Examine Figure E-5.

Figure E-5 Memory Throughput Bound Pipeline

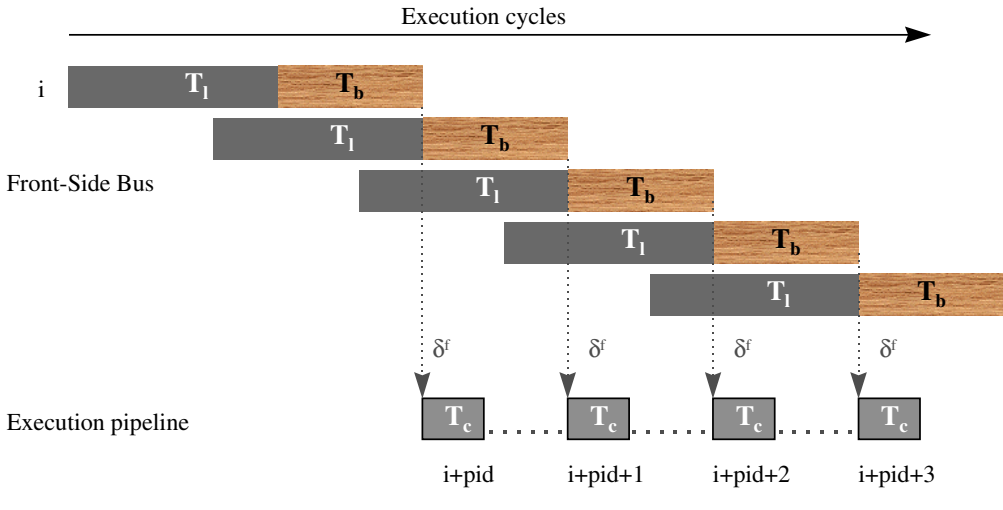

The following relationship calculates the prefetch scheduling distance (or prefetch iteration distance) for the case when memory throughput latency is greater than the compute latency.

$$psd = \left\lceil \frac{T_l + T_b}{T_b} \right\rceil = 1 + \left\lceil \frac{T_l}{T_b} \right\rceil > 1 \quad \text{if } T_l > T_b$$

Apparently, the iteration latency is dominant by the memory throughput and you cannot do much about it. Typically, data copy from one space to another space, for example, graphics driver moving data from writeback memory to you cannot do much about it. Typically, data copy from one space to another space, for example, graphics driver moving data from writeback memory to write-combining memory, belongs to this category, where performance advantage from prefetch instructions will be marginal.

Example

As an example of the previous cases consider the following conditions for computation latency and the memory throughput latencies. Assume $T_l = 18$ and $T_b = 8$ (in front side bus cycles).

$$\text{if } T_c \geq 26 \Rightarrow psd = \left\lceil \frac{18+8}{T_c} \right\rceil = 1$$

$$\text{if } 26 > T_c > 8 \Rightarrow 2 \leq psd = \left\lceil \frac{18+8}{T_c} \right\rceil \leq 3$$

$$\text{if } T_c \leq 8 \Rightarrow psd = 1 + \left\lceil \frac{18}{8} \right\rceil = 4$$

Now for the case $T_l = 18$, $T_b = 8$ (2 cache lines are needed per iteration) examine the following graph. Consider the graph of accesses per iteration in example 1, Figure E-6.

Figure E-6 Accesses per Iteration, Example 1

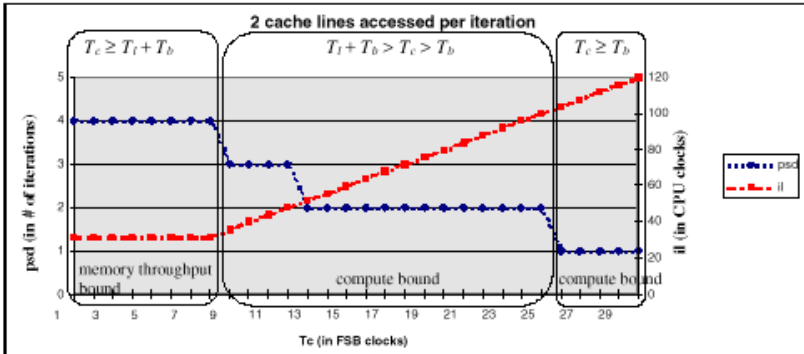

The prefetch scheduling distance is a step function of T_c , the computation latency. The steady state iteration latency (il) is either memory-bound or compute-bound depending on T_c if prefetches are scheduled effectively.

The graph in example 2 of accesses per iteration in Figure E-7 shows the results for prefetching multiple cache lines per iteration. The cases shown are for 2, 4, and 6 cache lines per iteration, resulting in differing burst latencies. ($T_l=18$, $T_b=8, 16, 24$).

Figure E-7 Accesses per Iteration, Example 2

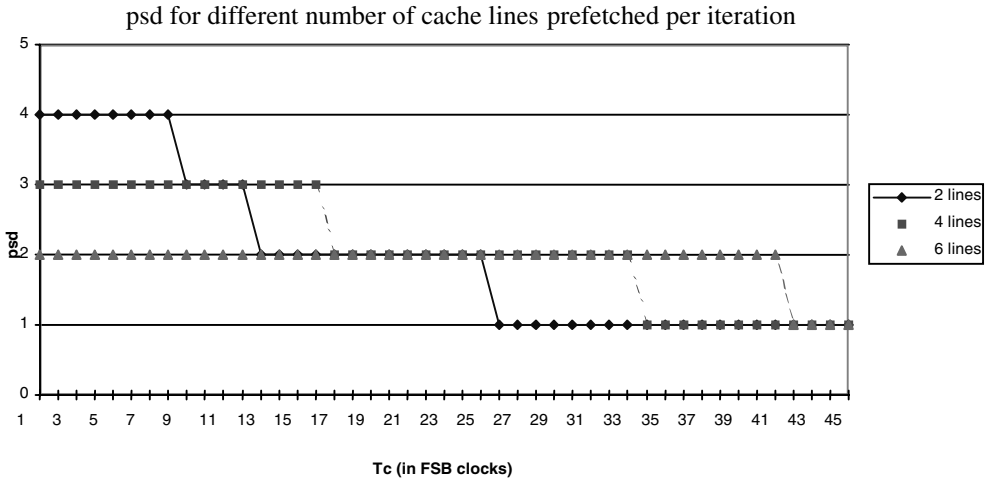

In reality, the front-side bus (FSB) pipelining depth is limited, that is, only four transactions are allowed at a time in the Pentium III and Pentium 4 processors. Hence a transaction bubble or gap, T_g , (gap due to idle bus or imperfect front side bus pipelining) will be observed on FSB activities. This leads to consideration of the transaction gap in computing the prefetch scheduling distance. The transaction gap, T_g , must be factored into the burst cycles, T_b , for the calculation of prefetch scheduling distance.

The following relationship shows computation of the transaction gap.

$$T_g = \max(T_l - c * (n - 1), 0)$$

where T_l is the memory leadoff latency, c is the number of chunks per cache line and n is the FSB pipelining depth.

Index

A

- absolute difference of signed numbers, 4-24
- absolute difference of unsigned numbers, 4-23
- absolute value, 4-25
- accesses per iteration, E-11, E-12
- algorithm to avoid changing the rounding mode, 2-63
- aligned ebp-based frame, D-4, D-6
- aligned esp-based stack frames, D-4
- Alignment
 - stack, 2-42
- alignment, 2-28
 - coe, 2-54
- AoS format, 3-28
- application performance tools, A-1
- Arrays
 - Aligning, 2-39
- automatic processor dispatch support, A-4
- automatic vectorization, 3-16, 3-17

B - C

- Branch Prediction, 2-4, 2-13
- .cache blocking techniques, 6-32
- cache level, 6-6
- cache management
 - simple memory copy, 6-43
 - video decoder, 6-42
 - video encoder, 6-42
- calculating insertion for scheduling distance, E-3
- call graph profiling, A-10
- changing the rounding mode, 2-62
- checking for MMX technology support, 3-2
- checking for Streaming SIMD Extensions support, 3-3
- classes (C/C++), 3-15
- clipping to an arbitrary signed range, 4-26
- clipping to an arbitrary unsigned range, 4-29
- code optimization options, A-3
- Code segment
 - Data in, 2-46
- coding methodologies, 3-11
- coding techniques, 3-10
 - absolute difference of signed numbers, 4-24
 - absolute difference of unsigned numbers, 4-23
 - absolute value, 4-25
 - clipping to an arbitrary signed range, 4-26
 - clipping to an arbitrary unsigned range, 4-29
 - generating constants, 4-21
 - interleaved pack with saturation, 4-8
 - interleaved pack without saturation, 4-10
 - non-interleaved unpack, 4-11
 - signed unpack, 4-7
 - simplified clipping to an arbitrary signed range, 4-28
 - unsigned unpack, 4-6
- coherent requests, 6-13

- command-line options, A-2
 - automatic processor dispatch support, A-4
 - floating-point arithmetic precision, A-6
 - inline expansion of library functions, A-6
 - loop unrolling, A-5
 - rounding control, A-6
 - targeting a processor, A-3
 - vectorizer switch, A-5
- comparing register values, 2-76
- compiler intrinsics
 - `_mm_load`, 6-2, 6-41
 - `_mm_prefetch`, 6-2, 6-41
 - `_mm_stream`, 6-2, 6-41
- compiler plug-in, A-2
- compiler-supported alignment, 3-22
- complex instructions, 2-70
- computation latency, E-8
- computation-intensive code, 3-9
- compute bound, E-7, E-8
- converting code to MMX technology, 3-6
- CPUID instruction, 3-2

D

- Data
 - Code segment and, 2-46
- data alignment, 3-18
- data arrangement, 5-4
- data copy, E-10
- data deswizzling, 5-13, 5-14
- Data structures
 - Access pattern versus alignment, 2-40
 - Aligning, 2-39
- data swizzling, 5-9
- data swizzling using intrinsics, 5-11
- decoupled memory, E-7
- divide instructions, 2-72

E

- eliminating branches, 2-13, 2-16
- EMMS instruction, 4-3, 4-4
- extract word instruction, 4-13

F

- fist instruction, 2-61
- `fildw` instruction, 2-62
- floating-point applications, 2-55
- floating-point arithmetic precision options, A-6
- floating-point code
 - improving parallelism, 2-65
 - loop unrolling, 2-25
 - memory access stall information, 2-36
 - memory operands, 2-67
 - operations with integer operands, 2-68
 - optimizing, 2-55
 - transcendental functions, 2-69
- floating-point operations with integer operands, 2-68
- floating-point stalls, 2-68
- flow dependency, E-7
- flush to zero, 5-21
- FXCH instruction, 2-67

G

- general optimization techniques, 2-1
 - branch prediction, 2-13
 - static prediction, 2-17
- generating constants, 4-21

H

- horizontal computations, 5-17
- hotspots, 3-8
- Hyper-Threading Technology, 7-1
 - avoid excessive software prefetches, 7-23
 - cache blocking technique, 7-26

- conserve bus command bandwidth, 7-23
- eliminate 64-K-aliased data accesses, 7-27
- Front-end Optimization, 7-33
- front-end optimization, 7-33
- full write transactions, 7-25
- functional decomposition, 7-7
- improve effective latency of cache misses, 7-24
- managing heavily-used execution Resources, 7-37
- memory optimization, 7-25
- minimize data sharing between physical processors, 7-26
- Multitasking Environment, 7-4
- optimization guidelines, 7-9
- optimization with spin-locks, 7-17
- parallel programming models, 7-6
- per-instance stack offset, 7-31
- per-thread stack offset, 7-29
- placement of shared synchronization variable, 7-22
- prevent false-sharing of data, 7-21
- preventing excessive evictions in first-level data cache, 7-28
- shared-memory optimization, 7-26
- synchronization for longer periods, 7-18
- synchronization for short periods, 7-13
- system bus optimization, 7-22
- thread synchronization, 7-13
- tools for creating multithreaded applications, 7-8

I

- increasing bandwidth of memory fills, 4-37
- increasing bandwidth of video fills, 4-37
- indirect branch, 2-22
- inline assembly, 4-5
- inline expansion of library functions option, A-6
- inlined assembly blocks, D-10
- inlined-asm, 3-13

- insert word instruction, 4-14
- instruction scheduling, 2-46, 4-38
- instruction selection, 2-69
- integer and floating-point multiply, 2-72
- integer divide, 2-72
- integer-intensive application, 4-1
- Intel Performance Library Suite, A-2
- interleaved pack with saturation, 4-8
- interleaved pack without saturation, 4-10
- interprocedural optimization, A-6
- IPO. See interprocedural optimization

L

- large load stalls, 2-37
- latency, 2-68, 6-5
- lea instruction, 2-70
- loading and storing to and from the same DRAM page, 4-38
- loop blocking, 3-32
- loop unrolling, 2-25
- loop unrolling option, A-5

M

- memory bank conflicts, 6-3
- memory O=optimization U=using P=prefetch, 6-18
- memory operands, 2-67
- memory optimization, 4-34
- memory optimizations
 - loading and storing to and from the same DRAM page, 4-38
 - partial memory accesses, 4-35
 - using aligned stores, 4-38
- memory performance, 3-25
- memory reference instructions, 2-75
- memory throughput bound, E-9
- minimizing prefetches number, 6-26

- misaligned data access, 3-18
- misalignment in the FIR filter, 3-19
- move byte mask to integer, 4-16
- MOVQ Instruction, 4-37

N

- new SIMD-integer instructions
 - extract word, 4-13
 - insert word, 4-14
 - move byte mask to integer, 4-16
 - packed average byte or word), 4-31
 - packed multiply high unsigned, 4-30
 - packed shuffle word, 4-18
 - packed signed integer word maximum, 4-30
 - packed sum of absolute differences, 4-30
- Newton-Raphson iteration, 5-2
- non-coherent requests, 6-13
- non-interleaved unpack, 4-11
- non-temporal stores, 6-40
- NOPs, 2-84
 - To align instructions, 2-84
 - XCHG EAX,EAX
 - Special hardware support for, 2-84
- numeric exceptions
 - flush to zero, 5-21

O

- optimizing cache utilization
 - cache management, 6-41
 - examples, 6-15
 - non-temporal store instructions, 6-9
 - prefetch and load, 6-8
 - prefetch Instructions, 6-7
 - prefetching, 6-6
 - SFENCE instruction, 6-15, 6-16
 - streaming, non-temporal stores, 6-9
- optimizing floating-point applications
 - copying, shuffling, 5-16
 - data arrangement, 5-4

- data deswizzling, 5-13
- data swizzling using intrinsics, 5-11
- horizontal ADD, 5-17
- planning considerations, 5-2
- rules and suggestions, 5-1
- scalar code, 5-3
- vertical versus horizontal computation, 5-5

- optimizing floating-point code, 2-55

P

- pack instruction, 4-10
- pack instructions, 4-8
- packed average byte or word), 4-31
- packed multiply high unsigned, 4-30
- packed shuffle word, 4-18
- packed signed integer word maximum, 4-30
- packed sum of absolute differences, 4-30
- parallelism, 3-10, E-7
- parameter alignment, D-4
- partial memory accesses, 4-35
- PAVGB instruction, 4-31
- PAVGW instruction, 4-31
- Performance and Usage Models
 - Multithreading, 7-2
 - Performance and Usage Models, 7-2
- Performance Library Suite, A-12
 - architecture, A-13
 - optimizations, A-14
- PEXTRW instruction, 4-13
- PGO. See profile-guided optimization
- PINSRW instruction, 4-14
- PMINSW instruction, 4-30
- PMINUB instruction, 4-30
- PMOVMASKB instruction, 4-16
- PMULHUW instruction, 4-30
- predictable memory access patterns, 6-7
- prefetch and cacheability Instructions, 6-4
- prefetch and load Instructions, 6-8

prefetch concatenation, 6-24, 6-25
 prefetch instruction, 6-1
 prefetch instruction considerations, 6-22

- cache blocking techniques, 6-32
- concatenation, 6-24
- minimizing prefetches number, 6-26
- no preloading or prefetch, E-6
- prefetch scheduling distance, E-5
- scheduling distance, 6-23
- single-pass execution, 6-3, 6-37
- spread prefetch with computatin instructions, 6-30
- strip-mining, 6-35

 prefetch instructions, 6-7
 prefetch scheduling distance, 6-23, E-5, E-7, E-10
 prefetch use

- predictable memory access patterns, 6-7
- time-consuming innermost loops, 6-7

 prefetching, A-5
 prefetching concept, 6-6
 prefetchnta instruction, 6-34
 profile-guided optimization, A-7
 prolog sequences, 2-79
 PSADBW instruction, 4-30
 PSHUF instruction, 4-18

R

reciprocal instructions, 5-2
 rounding control option, A-6

S

sampling

- event-based, A-9

 Self-modifying code, 2-46
 SFENCE Instruction, 6-15, 6-16
 signed unpack, 4-7
 SIMD integer code, 4-2

SIMD-floating-point code, 5-1
 simple memory copy, 6-43
 simplified 3D geometry pipeline, 6-20
 simplified clipping to an arbitrary signed range, 4-28
 single-pass versus multi-pass execution, 6-37
 SoA format, 3-28
 software write-combining, 6-40
 spread prefetch, 6-31
 Stack Alignment

- Example of dynamic, 2-43

 Stack alignment, 2-42
 stack alignment, 3-20
 stack frame, D-2
 stack frame optimization, D-9
 static branch prediction algorithm, 2-18
 static prediction, 2-17
 static prediction algorithm, 2-17
 streaming store, 6-43
 streaming stores

- coherent requests, 6-13
- non-coherent requests, 6-13

 strip mining, 3-30, 3-33
 strip-mining, 6-35, 6-36
 Structs

- Aligning, 2-39

 swizzling data. See data swizzling.
 System Bus Optimization, 7-22

T

targeting a processor option, A-3
 time-based sampling, A-8
 time-consuming innermost loops, 6-7
 TLB. See transaction lookaside buffer
 transaction lookaside buffer, 6-44
 transcendental functions, 2-69
 transfer latency, E-7, E-9

U

- unpack instructions, 4-11
- unsigned unpack, 4-6
- using MMX code for copy or shuffling functions, 5-16

V

- vector class library, 3-15
- vectorization, 3-10
- vectorized code, 3-16
- vectorizer switch options, A-5
- vertical versus horizontal computation, 5-5
- VTune analyzer, 3-8, A-1
- VTune Performance Analyzer, 3-8

W

- write-combining buffer, 6-40
- write-combining memory, 6-40



INTEL SALES OFFICES

ASIA PACIFIC

Australia
Intel Corp.
Level 2
448 St Kilda Road
Melbourne VIC
3004
Australia
Fax:613-9862 5599

China

Intel Corp.
Rm 709, Shaanxi
Zhongda Int'l Bldg
No.30 Nandajie Street
Xian AX710002
China
Fax:(86 29) 7203356

Intel Corp.
Rm 2710, Metropolitan
Tower
68 Zourong Rd
Chongqing CQ
400015
China

Intel Corp.
C1, 15 Flr, Fujian
Oriental Hotel
No. 96 East Street
Fuzhou FJ
350001
China

Intel Corp.
Rm 5803 CITIC Plaza
233 Tianhe Rd
Guangzhou GD
510613
China

Intel Corp.
Rm 1003, Orient Plaza
No. 235 Huayuan Street
Nangang District
Harbin HL
150001
China

Intel Corp.
Rm 1751 World Trade
Center, No 2
Han Zhong Rd
Nanjing JS
210009
China

Intel Corp.
Hua Xin International
Tower
215 Qing Nian St.
ShenYang LN
110015
China

Intel Corp.
Suite 1128 CITIC Plaza
Jinan
150 Yuan St.
Jinan SN
China

Intel Corp.
Suite 412, Holiday Inn
Crowne Plaza
31, Zong Fu Street
Chengdu SU
610041
China
Fax:86-28-6785965

Intel Corp.
Room 0724, White Rose
Hotel
No 750, MinZhu Road
WuChang District
Wuhan UB
430071
China

India

Intel Corp.
Paharpur Business
Centre
21 Nehru Place
New Delhi DH
110019
India

Intel Corp.
Hotel Rang Sharda, 6th
Floor
Bandra Reclamation
Mumbai MH
400050
India
Fax:91-22-6415578

Intel Corp.
DBS Corporate Club
31A Cathedral Garden
Road
Chennai TD
600034
India

Intel Corp.
DBS Corporate Club
2nd Floor, 8 A.A.C. Bose
Road
Calcutta WB
700017
India

Japan

Intel Corp.
Kokusai Bldg 5F, 3-1-1,
Marunouchi
Chiyoda-Ku, Tokyo
1000005
Japan

Intel Corp.
2-4-1 Terauchi
Toyonaka-Shi
Osaka
5600872
Japan

Malaysia

Intel Corp.
Lot 102 1/F Block A
Wisma Semantan
12 Jalan Gelenggang
Damansara Heights
Kuala Lumpur SL
50490
Malaysia

Thailand

Intel Corp.
87 M. Thai Tower, 9th Fl.
All Seasons Place,
Wireless Road
Lumpini, Patumwan
Bangkok
10330
Thailand

Viet Nam

Intel Corp.
Hanoi Tung Shing
Square, Ste #1106
2 Ngo Quyen St
Hoan Kiem District
Hanoi
Viet Nam

EUROPE & AFRICA

Belgium
Intel Corp.
Woluwelaan 158
Diegem
1831
Belgium

Czech Rep

Intel Corp.
Nahorní 14
Brno
61600
Czech Rep

Denmark

Intel Corp.
Soelodden 13
Maaloev
DK2760
Denmark

Germany

Intel Corp.
Sandstrasse 4
Aicher
86551
Germany

Intel Corp.
Dr Weyerstrasse 2
Juelich
52428
Germany

Intel Corp.
Buchenweg 4
Wildberg
72218
Germany

Intel Corp.
Kemnader Strasse 137
Bochum
44797
Germany

Intel Corp.
Klaus-Schaefer Strasse
16-18
Erfstadt NW
50374
Germany

Intel Corp.
Heldmanskamp 37
Lemgo NW
32657
Germany

Italy

Intel Corp Italia Spa
Milanofiori Palazzo E/4
Assago
Milan
20094
Italy
Fax:39-02-57501221

Netherlands

Intel Corp.
Strausslaan 31
Heesch
5384CW
Netherlands

Poland

Intel Poland
Developments, Inc
Jerzolimskie Business
Park
Jerzolimskie 146C
Warsaw
2305
Poland
Fax:+48-22-570 81 40

Portugal

Intel Corp.
PO Box 20
Alcabideche
2765
Portugal

Spain

Intel Corp.
Calle Rioja, 9
Bajo F Izquierda
Madrid
28042
Spain

South Africa

Intel SA Corporation
Bldg 14, South Wing,
2nd Floor
Uplands, The Woodlands
Western Services Road
Woodmead
2052
Sth Africa
Fax:+27 11 806 4549

Intel Corp.
19 Summit Place,
Halfway House
Cnr 5th and Harry
Galaun Streets
Midrad
1685
Sth Africa

United Kingdom

Intel Corp.
The Marse
Silver Lane
Needingworth CAMBS
PE274SL
UK

Intel Corp.
2 Cameron Close
Long Melford SUFFK
CO109TS
UK

Israel

Intel Corp.
MTM Industrial Center,
P.O.Box 498
Haifa
31000
Israel
Fax:972-4-8655444

LATIN AMERICA & CANADA

Argentina
Intel Corp.
Dock IV - Bldg 3 - Floor 3
Olga Cossentini 240
Buenos Aires
C1107BVA
Argentina

Brazil

Intel Corp.
Rua Carlos Gomez
940 - 10th Floor
Porto Alegre
90480-003
Brazil

Intel Corp.
Av. Dr. Churci Zaidan
940 - 10th Floor
San Paulo
04583-904
Brazil

Intel Corp.
Av. Rio Branco,
1 - Sala 1804
Rio de Janeiro
20090-003
Brazil

Columbia

Intel Corp.
Carrera 7 No. 71021
Torre B, Oficina 603
Santefe de Bogota
Columbia

Mexico

Intel Corp.
Av. Mexico No. 2798-9B,
S.H.
Guadalajara
44680
Mexico

Intel Corp.
Torre Esmeralda II,
7th Floor
Blvd. Manuel Avila
Comacho #36
Mexico Cith DF
11000
Mexico

Intel Corp.
Piso 19, Suite 4
Av. Batallon de San
Patricio No 111
Monterrey, Nuevo le
66269
Mexico

Canada

Intel Corp.
168 Bonis Ave, Suite 202
Scarborough
MIT3V6
Canada
Fax:416-335-7695

Intel Corp.
3901 Highway #7,
Suite 403
Vaughan
L4L 8L5
Canada
Fax:905-856-8868



Intel Corp.
999 CANADA PLACE,
Suite 404, #11
Vancouver BC
V6C 3E2
Canada
Fax:604-844-2813

Intel Corp.
2650 Queensview Drive,
Suite 250
Ottawa ON
K2B 8H6
Canada
Fax:613-820-5936

Intel Corp.
190 Attwell Drive,
Suite 500
Rexdale ON
M9W 6H8
Canada
Fax:416-675-2438

Intel Corp.
171 St. Clair Ave. E.,
Suite 6
Toronto ON
Canada

Intel Corp.
1033 Oak Meadow Road
Oakville ON
L6M 1J6
Canada

USA
California
Intel Corp.
551 Lundy Place
Milpitas CA
95035-6833
USA
Fax:408-451-8266

Intel Corp.
1551 N. Tustin Avenue,
Suite 800
Santa Ana CA
92705
USA
Fax:714-541-9157

Intel Corp.
Executive Center del Mar
12230 El Camino Real
Suite 140
San Diego CA
92130
USA
Fax:858-794-5805

Intel Corp.
1960 E. Grand Avenue,
Suite 150
El Segundo CA
90245
USA
Fax:310-640-7133

Intel Corp.
23120 Alicia Parkway,
Suite 215
Mission Viejo CA
92692
USA
Fax:949-586-9499

Intel Corp.
30851 Agoura Road
Suite 202
Agoura Hills CA
91301
USA
Fax:818-874-1166

Intel Corp.
28202 Cabot Road,
Suite #363 & #371
Laguna Niguel CA
92677
USA

Intel Corp.
657 S Cendros Avenue
Solana Beach CA
90075
USA

Intel Corp.
43769 Abeloe Terrace
Fremont CA
94539
USA

Intel Corp.
1721 Warburton, #6
Santa Clara CA
95050
USA

Colorado
Intel Corp.
600 S. Cherry Street,
Suite 700
Denver CO
80222
USA
Fax:303-322-8670

Connecticut
Intel Corp.
Lee Farm Corporate Pk
83 Wooster Heights
Road
Danbury CT
6810
USA
Fax:203-778-2168

Florida
Intel Corp.
7777 Glades Road
Suite 310B
Boca Raton FL
33434
USA
Fax:813-367-5452

Georgia
Intel Corp.
20 Technology Park,
Suite 150
Norcross GA
30092
USA
Fax:770-448-0875

Intel Corp.
Three Northwinds Center
2500 Northwinds
Parkway, 4th Floor
Alpharetta GA
30092
USA
Fax:770-663-6354

Idaho
Intel Corp.
910 W. Main Street, Suite
236
Boise ID
83702
USA
Fax:208-331-2295

Illinois
Intel Corp.
425 N. Martingale Road
Suite 1500
Schaumburg IL
60173
USA
Fax:847-605-9762

Intel Corp.
999 Plaza Drive
Suite 360
Schaumburg IL
60173
USA

Intel Corp.
551 Arlington Lane
South Elgin IL
60177
USA

Indiana
Intel Corp.
9465 Counselors Row,
Suite 200
Indianapolis IN
46240
USA
Fax:317-805-4939

Massachusetts
Intel Corp.
125 Nagog Park
Acton MA
01720
USA
Fax:978-266-3867

Intel Corp.
59 Composit Way
suite 202
Lowell MA
01851
USA

Intel Corp.
800 South Street,
Suite 100
Waltham MA
02154
USA

Maryland
Intel Corp.
131 National Business
Parkway, Suite 200
Annapolis Junction MD
20701
USA
Fax:301-206-3678

Michigan
Intel Corp.
32255 Northwestern
Hwy., Suite 212
Farmington Hills MI
48334
USA
Fax:248-851-8770

Minnesota
Intel Corp.
3600 W 80th St
Suite 450
Bloomington MN
55431
USA
Fax:952-831-6497

North Carolina
Intel Corp.
2000 CentreGreen Way,
Suite 190
Cary NC
27513
USA
Fax:919-678-2818

New Hampshire
Intel Corp.
7 Suffolk Park
Nashua NH
03063
USA

New Jersey
Intel Corp.
90 Woodbridge Center
Dr. Suite. 240
Woodbridge NJ
07095
USA
Fax:732-602-0096

New York
Intel Corp.
628 Crosskeys Office Pk
Fairport NY
14450
USA
Fax:716-223-2561

Intel Corp.
888 Veterans Memorial
Highway
Suite 530
Hauppauge NY
11788
USA
Fax:516-234-5093

Ohio
Intel Corp.
3401 Park Center Drive
Suite 220
Dayton OH
45414
USA
Fax:937-890-8658

Intel Corp.
56 Milford Drive
Suite 205
Hudson OH
44236
USA
Fax:216-528-1026

Oregon
Intel Corp.
15254 NW Greenbrier
Parkway, Building B
Beaverton OR
97006
USA
Fax:503-645-8181

Pennsylvania
Intel Corp.
925 Harvest Drive
Suite 200
Blue Bell PA
19422
USA
Fax:215-641-0785

Intel Corp.
7500 Brooktree
Suite 213
Wexford PA
15090
USA
Fax:714-541-9157

Texas
Intel Corp.
5000 Quorum Drive,
Suite 750
Dallas TX
75240
USA
Fax:972-233-1325

Intel Corp.
20445 State Highway
249, Suite 300
Houston TX
77070
USA
Fax:281-376-2891

Intel Corp.
8911 Capital of Texas
Hwy, Suite 4230
Austin TX
78759
USA
Fax:512-338-9335

Intel Corp.
7739 La Verdura Drive
Dallas TX
75248
USA

Intel Corp.
77269 La Cabeza Drive
Dallas TX
75249
USA

Intel Corp.
3307 Northland Drive
Austin TX
78731
USA

Intel Corp.
15190 Prestonwood
Blvd. #925
Dallas TX
75248
USA
Intel Corp.

Washington
Intel Corp.
2800 156Th Ave. SE
Suite 105
Bellevue WA
98007
USA
Fax:425-746-4495

Intel Corp.
550 Kirkland Way
Suite 200
Kirkland WA
98033
USA

Wisconsin
Intel Corp.
405 Forest Street
Suites 109/112
Oconomowoc WI
53066
USA