

Specification Agreement

This Specification Agreement (this “Agreement”) is a legal agreement between Advanced Micro Devices, Inc. (“AMD”) and “You” as the recipient of the attached AMD Specification (the “Specification”). If you are accessing the Specification as part of your performance of work for another party, you acknowledge that you have authority to bind such party to the terms and conditions of this Agreement. If you accessed the Specification by any means or otherwise use or provide Feedback (defined below) on the Specification, You agree to the terms and conditions set forth in this Agreement. If You do not agree to the terms and conditions set forth in this Agreement, you are not licensed to use the Specification; do not use, access or provide Feedback about the Specification.

In consideration of Your use or access of the Specification (in whole or in part), the receipt and sufficiency of which are acknowledged, You agree as follows:

1. You may review the Specification only (a) as a reference to assist You in planning and designing Your product, service or technology (“Product”) to interface with an AMD product in compliance with the requirements as set forth in the Specification and (b) to provide Feedback about the information disclosed in the Specification to AMD.
2. Except as expressly set forth in Paragraph 1, all rights in and to the Specification are retained by AMD. This Agreement does not give You any rights under any AMD patents, copyrights, trademarks or other intellectual property rights. You may not (i) duplicate any part of the Specification; (ii) remove this Agreement or any notices from the Specification, or (iii) give any part of the Specification, or assign or otherwise provide Your rights under this Agreement, to anyone else.
3. The Specification may contain preliminary information, errors, or inaccuracies, or may not include certain necessary information. Additionally, AMD reserves the right to discontinue or make changes to the Specification and its products at any time without notice. The Specification is provided entirely “AS IS.” AMD MAKES NO WARRANTY OF ANY KIND AND DISCLAIMS ALL EXPRESS, IMPLIED AND STATUTORY WARRANTIES, INCLUDING BUT NOT LIMITED TO IMPLIED WARRANTIES OF MERCHANTABILITY, FITNESS FOR A PARTICULAR PURPOSE, NON-INFRINGEMENT, TITLE OR THOSE WARRANTIES ARISING AS A COURSE OF DEALING OR CUSTOM OF TRADE. AMD SHALL NOT BE LIABLE FOR DIRECT, INDIRECT, CONSEQUENTIAL, SPECIAL, INCIDENTAL, PUNITIVE OR EXEMPLARY DAMAGES OF ANY KIND (INCLUDING LOSS OF BUSINESS, LOSS OF INFORMATION OR DATA, LOST PROFITS, LOSS OF CAPITAL, LOSS OF GOODWILL) REGARDLESS OF THE FORM OF ACTION WHETHER IN CONTRACT, TORT (INCLUDING NEGLIGENCE) AND STRICT PRODUCT LIABILITY OR OTHERWISE, EVEN IF ADVISED OF THE POSSIBILITY OF SUCH DAMAGES.
4. Furthermore, AMD’s products are not designed, intended, authorized or warranted for use as components in systems intended for surgical implant into the body, or in other applications intended to support or sustain life, or in any other application in which the failure of AMD’s product could create a situation where personal injury, death, or severe property or environmental damage may occur.
5. You have no obligation to give AMD any suggestions, comments or feedback (“Feedback”) relating to the Specification. However, any Feedback You voluntarily provide may be used by AMD without restriction, fee or obligation of confidentiality. Accordingly, if You do give AMD Feedback on

any version of the Specification, You agree AMD may freely use, reproduce, license, distribute, and otherwise commercialize Your Feedback in any product, as well as has the right to sublicense third parties to do the same. Further, You will not give AMD any Feedback that You may have reason to believe is (i) subject to any patent, copyright or other intellectual property claim or right of any third party; or (ii) subject to license terms which seek to require any product or intellectual property incorporating or derived from Feedback or any Product or other AMD intellectual property to be licensed to or otherwise provided to any third party.

6. You shall adhere to all applicable U.S., European, and other export laws, including but not limited to the U.S. Export Administration Regulations (“EAR”), (15 C.F.R. Sections 730 through 774), and E.U. Council Regulation (EC) No 428/2009 of 5 May 2009. Further, pursuant to Section 740.6 of the EAR, You hereby certifies that, except pursuant to a license granted by the United States Department of Commerce Bureau of Industry and Security or as otherwise permitted pursuant to a License Exception under the U.S. Export Administration Regulations ("EAR"), You will not (1) export, re-export or release to a national of a country in Country Groups D:1, E:1 or E:2 any restricted technology, software, or source code You receive hereunder, or (2) export to Country Groups D:1, E:1 or E:2 the direct product of such technology or software, if such foreign produced direct product is subject to national security controls as identified on the Commerce Control List (currently found in Supplement 1 to Part 774 of EAR). For the most current Country Group listings, or for additional information about the EAR or Your obligations under those regulations, please refer to the U.S. Bureau of Industry and Security’s website at <http://www.bis.doc.gov/>.

7. If You are a part of the U.S. Government, then the Specification is provided with “RESTRICTED RIGHTS” as set forth in subparagraphs (c) (1) and (2) of the Commercial Computer Software-Restricted Rights clause at FAR 52.227-14 or subparagraph (c) (1)(ii) of the Rights in Technical Data and Computer Software clause at DFARS 252.277-7013, as applicable.

8. This Agreement is governed by the laws of the State of California without regard to its choice of law principles. Any dispute involving it must be brought in a court having jurisdiction of such dispute in Santa Clara County, California, and You waive any defenses and rights allowing the dispute to be litigated elsewhere. If any part of this agreement is unenforceable, it will be considered modified to the extent necessary to make it enforceable, and the remainder shall continue in effect. The failure of AMD to enforce any rights granted hereunder or to take action against You in the event of any breach hereunder shall not be deemed a waiver by AMD as to subsequent enforcement of rights or subsequent actions in the event of future breaches. This Agreement is the entire agreement between You and AMD concerning the Specification; it may be changed only by a written document signed by both You and an authorized representative of AMD.



AMD I/O Virtualization Technology (IOMMU) Specification

Publication # **48882**

Revision: **3.07-PUB**

Issue Date: **October 2022**

The information contained herein is for informational purposes only, and is subject to change without notice. While every precaution has been taken in the preparation of this document, it may contain technical inaccuracies, omissions and typographical errors, and AMD is under no obligation to update or otherwise correct this information. Advanced Micro Devices, Inc. makes no representations or warranties with respect to the accuracy or completeness of the contents of this document, and assumes no liability of any kind, including the implied warranties of noninfringement, merchantability or fitness for particular purposes, with respect to the operation or use of AMD hardware, software or other products described herein. No license, including implied or arising by estoppel, to any intellectual property rights is granted by this document. Terms and limitations applicable to the purchase or use of AMD's products are as set forth in a signed agreement between the parties or in AMD's Standard Terms and Conditions of Sale.

Any unauthorized copying, alteration, distribution, transmission, performance, display or other use of this material is prohibited.

Trademarks

AMD, the AMD Arrow logo, and combinations thereof are trademarks of Advanced Micro Devices, Inc. Other product names used in this publication are for identification purposes only and may be trademarks of their respective companies. HyperTransport is a licensed trademark of the HyperTransport Technology Consortium

PCI Express, PCIe and PCI-X are registered trademarks of PCI-Special Interest Group (PCI-SIG).

Reverse engineering or disassembly is prohibited.

USE OF THIS PRODUCT IN ANY MANNER THAT COMPLIES WITH THE MPEG ACTUAL OR DE FACTO VIDEO AND/OR AUDIO STANDARDS IS EXPRESSLY PROHIBITED WITHOUT ALL NECESSARY LICENSES UNDER APPLICABLE PATENTS. SUCH LICENSES MAY BE ACQUIRED FROM VARIOUS THIRD PARTIES INCLUDING, BUT NOT LIMITED TO, IN THE MPEG PATENT PORTFOLIO, WHICH LICENSE IS AVAILABLE FROM MPEG LA, L.L.C., 6312 S. FIDDLERS GREEN CIRCLE, SUITE 400E, GREENWOOD VILLAGE, COLORADO 80111.

Contents

	Contents	5
	Figures	9
	Tables	13
	Revision History	17
	Preface	21
1	IOMMU Overview	31
	1.1 Summary of IOMMU Capabilities	31
	1.2 Usage Models	33
	1.2.1 Replacing the GART	33
	1.2.2 Replacing the Device Exclusion Vector Mechanism	34
	1.2.3 32-bit to 64-bit Legacy I/O Device Mapping	34
	1.2.4 User Mode Device Accesses	35
	1.2.5 Virtual Machine Guest Access to Devices	35
	1.2.6 Virtualizing the IOMMU	36
	1.2.7 Virtualized User Mode Device Accesses	36
	1.3 IOMMU Optional Features	37
	1.3.1 Two-level Translation for Guest and Host Address Spaces	40
	1.3.2 Enhanced Processor Page Table Compatibility	42
	1.3.3 Performance Features	42
	1.3.4 Address Translation Services for Guest Virtual Addresses	44
	1.3.5 Peripheral Page Request Support Compatible with PCI-SIG PRI	45
	1.3.6 Selecting Translation Tables in a Memory Transaction	45
	1.3.7 AMD64 Interrupt Virtualization (Guest Virtual APIC Interrupt Controller)	45
	1.3.8 Enhanced Support for Access and Dirty Bits	46
	1.3.9 Guest I/O Protection	46
	1.3.10 SMI Filter	46
	1.3.11 Hardware Error Registers	46
	1.3.12 Hardware Accelerated Virtualized IOMMU (vIOMMU)	46
	1.3.13 Secure Nested Paging (SEV-SNP)	47
2	Architecture	49
	2.1 Behavior	49
	2.1.1 Normal Operation	49
	2.1.2 IOMMU Logical Topology	51
	2.1.3 IOMMU Event Reporting	51
	2.1.4 Special Conditions	53
	2.1.5 System Management Interrupt (SMI) Controls	55
	2.2 Data Structures	58
	2.2.1 Updating Shared Tables	60
	2.2.2 Device Table	60
	2.2.3 I/O Page Tables for Host Translations	77
	2.2.4 Sharing AMD64 Processor and IOMMU Page Tables—GPA-to-SPA	86
	2.2.5 Interrupt Remapping Tables	87

2.2.6	I/O Page Tables for Guest Translations	97
2.2.7	Guest and Nested Address Translation	111
2.2.8	Guest Virtual APIC Table for Interrupt Virtualization	117
2.2.9	Guest I/O Protection	117
2.3	Starting the IOMMU	118
2.3.1	Data Structure Initialization	118
2.3.2	Making Guest Interrupt Virtualization Changes	119
2.4	Commands	119
2.4.1	COMPLETION_WAIT	121
2.4.2	INVALIDATE_DEVTAB_ENTRY	123
2.4.3	INVALIDATE_IOMMU_PAGES	124
2.4.4	INVALIDATE_IOTLB_PAGES	125
2.4.5	INVALIDATE_INTERRUPT_TABLE	128
2.4.6	PREFETCH_IOMMU_PAGES	129
2.4.7	COMPLETE_PPR_REQUEST	132
2.4.8	INVALIDATE_IOMMU_ALL	133
2.4.9	INSERT_GUEST_EVENT Command	134
2.4.10	RESET_VMMIO Command	135
2.4.11	IOMMU Ordering Rules	136
2.5	Event Logging	137
2.5.1	Event Log Restart Procedure	138
2.5.2	ILLEGAL_DEV_TABLE_ENTRY Event	147
2.5.3	IO_PAGE_FAULT Event	149
2.5.4	DEV_TAB_HARDWARE_ERROR Event	151
2.5.5	PAGE_TAB_HARDWARE_ERROR Event	153
2.5.6	ILLEGAL_COMMAND_ERROR Event	155
2.5.7	COMMAND_HARDWARE_ERROR Event	156
2.5.8	IOTLB_INV_TIMEOUT Event	157
2.5.9	INVALID_DEVICE_REQUEST Event	158
2.5.10	INVALID_PPR_REQUEST Event	160
2.5.11	EVENT_COUNTER_ZERO Event	162
2.5.12	GUEST_EVENT_FAULT Event	163
2.5.13	VIOMMU_HARDWARE_ERROR Event	164
2.5.14	RMP_PAGE_FAULT Event	165
2.5.15	RMP_HARDWARE_ERROR Event	167
2.5.16	IOMMU Event Reporting	169
2.5.17	Event Log Dual Buffering	171
2.6	Peripheral Page Request (PPR) Logging	172
2.6.1	PPR Log Dual Buffering	174
2.6.2	Peripheral Page Request Log Restart Procedure	175
2.6.3	Peripheral Page Request Entry	176
2.6.4	PPR Log Overflow Protection	178
2.7	Guest Virtual APIC (GA) Logging	180
2.7.1	Guest vAPIC Virtual Interrupt Request Log	181
2.7.2	Guest Virtual APIC Log Entry (Generic)	184
2.7.3	Guest Virtual APIC Request Entry (GA_GUEST_NR)	184
2.7.4	Guest Virtual APIC Log Restart Procedure	185

2.8	IOMMU Interrupt Support	185
2.9	Memory Address Routing and Control (MARC)	186
2.10	vIOMMU	187
2.10.1	vIOMMU Private Address Space	187
2.10.2	vIOMMU MMIO Resources	189
2.10.3	vIOMMU Event Logging	190
2.10.4	vIOMMU Extended Interrupt Remapping	190
2.10.5	vIOMMU and EOI Bus Cycle	192
2.11	Secure ATS Support	192
2.12	IOMMU Secure Nested Paging (SEV-SNP) Support	192
2.12.1	SEV-SNP RMP Access Checks	192
2.12.2	SEV-SNP Restrictions	193
2.12.3	SEV-SNP Guest Virtual APIC Support	194
3	Registers	195
3.1	PCI Resources	195
3.1.1	Accessing MSI Capability Block Registers	195
3.2	IOMMU Base Capability Block Registers	196
3.3	IOMMU Vendor Specific Capability Block Registers	201
3.4	IOMMU MMIO Registers	204
3.4.1	Control and Status Registers	204
3.4.2	PPR Log Registers	219
3.4.3	SMI Filter	221
3.4.4	Guest Virtual APIC Log Registers	222
3.4.5	Alternate PPR and Event Log Base Registers	225
3.4.6	Device Table Segment [1–7] Base Address Registers	227
3.4.7	Device-Specific Feature Registers	228
3.4.8	MMIO Access to MSI Capability Block Registers	230
3.4.9	Performance Optimization Control Register	233
3.4.10	IOMMU x2APIC Control Register	234
3.4.11	vIOMMU Status Register	237
3.4.12	Memory Access and Routing (MARC) Registers	237
3.4.13	Extended Feature 2 Register	240
3.4.14	Reserved Register	240
3.4.15	Command and Event Log Pointer Registers	241
3.4.16	Command and Event Status Register	243
3.4.17	PPR Log Head and Tail Pointer Registers	246
3.4.18	Guest Virtual APIC Log Head and Tail Pointer Registers	247
3.4.19	PPR Log B Head and Tail Pointer Registers	248
3.4.20	Event Log B Head and Tail Pointer Registers	249
3.4.21	PPR Log Overflow Protection Registers	250
3.4.22	IOMMU Event Counter Registers	252
3.5	IOMMU Virtual Function Controls MMIO Registers	263
3.6	IOMMU Virtual Function MMIO Registers	268
4	Implementation Considerations	271
4.1	Caching and Invalidation Strategies	271
4.2	IOMMU Topologies	272
4.3	Issues Specific to the HyperTransport™ Architecture	274

4.4	Chipset Specific Implementation Issues	275
4.5	Software and Platform Firmware Implementation Issues	275
5	I/O Virtualization ACPI Table	277
5.1	IOMMU Control Flow	278
5.2	I/O Virtualization Reporting Structure (IVRS)	278
5.2.1	IVRS Header Fields	280
5.2.2	I/O Virtualization Definition Blocks	281
5.3	I/O Virtualization Device Tree	297
5.3.1	I/O Virtualization Device Tree Data Structure	298
	Index to Registers	299

Figures

Figure 1:	Example Platform Architecture	33
Figure 2:	Nested Address Spaces	41
Figure 3:	System Management Interrupt Address Format	56
Figure 4:	IOMMU Data Structures	59
Figure 5:	Example DeviceID Derived from Peripheral RequesterID	60
Figure 6:	DeviceID Derived from Peripheral UnitID	61
Figure 7:	Device Table Entry (DTE) Fields	63
Figure 8:	I/O Page Table Entry Not Present (any level)	80
Figure 9:	I/O Page Translation Entry (PTE), PR=1	80
Figure 10:	I/O Page Directory Entry (PDE), PR=1	82
Figure 11:	Address Translation Example with Skipped Level and 2-Mbyte Page	84
Figure 12:	Address Translation Example with Page Size Larger than Default Size	85
Figure 13:	Sharing AMD64 and IOMMU Host Page Tables with Identical Addressing	87
Figure 14:	Interrupt Remapping Table Lookup for Fixed and Arbitrated Interrupts	89
Figure 15:	Interrupt Remapping Table Entry - Basic Format	89
Figure 16:	Bit Numbering of Virtual IRR in the Virtual APIC Backing Page	92
Figure 17:	IRTE Fields with Guest Virtual APIC, IRTE[GuestMode]=0	92
Figure 18:	IRTE Fields with Guest Virtual APIC, IRTE[GuestMode]=1	93
Figure 19:	IRTE Fields with Guest Virtual APIC, IRTE[GuestMode]=0	95
Figure 20:	IRTE Fields with Guest Virtual APIC, IRTE[GuestMode]=1	96
Figure 21:	Guest CR3 Table, 1 Level	98
Figure 22:	AMD64 GCR3 Base Pointer Entry Format	99
Figure 23:	Guest CR3 Table, 2 Level	100
Figure 24:	Guest CR3 Level-2 Base Table Pointer Format	101
Figure 25:	AMD64 Long Mode 4-Kbyte Page Address Translation	102
Figure 26:	AMD64 Long Mode 4-Kbyte PML5E Format	103
Figure 27:	AMD64 Long Mode 4-Kbyte PML4E Format	103
Figure 28:	AMD64 Long Mode 4-Kbyte PDPE Format	103
Figure 29:	AMD64 Long Mode 4-Kbyte PDE Format	103
Figure 30:	AMD64 Long Mode 4-Kbyte PTE Format	103
Figure 31:	AMD64 Long Mode 2-Mbyte Page Address Translation	105
Figure 32:	AMD64 Long Mode 2-Mbyte PML5E Format	105

Figure 33:	AMD64 Long Mode 2-Mbyte PML4E Format	106
Figure 34:	AMD64 Long Mode 2-Mbyte PDPE Format	106
Figure 35:	AMD64 Long Mode 2-Mbyte PDE Format	106
Figure 36:	AMD64 Long Mode 1-Gbyte Page Address Translation	108
Figure 37:	AMD64 Long Mode 1-Gbyte PML5E Format	108
Figure 38:	AMD64 Long Mode 1-Gbyte PML4E Format	108
Figure 39:	AMD64 Long Mode 1-Gbyte PDPE Format	108
Figure 40:	Complete GVA-to-SPA Address Translation	110
Figure 41:	PCIe [®] TLP PASID Prefix Payload Format	116
Figure 42:	Command Buffer in System Memory	120
Figure 43:	Generic Command Buffer Entry Format	121
Figure 44:	COMPLETION_WAIT Command Format	122
Figure 45:	INVALIDATE_DEVTAB_ENTRY Command Format	123
Figure 46:	INVALIDATE_IOMMU_PAGES Command Format	124
Figure 47:	INVALIDATE_IOTLB_PAGES Command Format	126
Figure 48:	INVALIDATE_INTERRUPT_TABLE Command Format	128
Figure 49:	PREFETCH_IOMMU_PAGES Command Format	130
Figure 50:	COMPLETE_PPR_REQUEST Command Format	132
Figure 51:	INVALIDATE_IOMMU_ALL Command Format	134
Figure 52:	Event Log in System Memory	137
Figure 53:	Event Log State Diagram	139
Figure 54:	Generic Event Log Buffer Entry	139
Figure 55:	ILLEGAL_DEV_TABLE_ENTRY Event Log Buffer Entry Format	147
Figure 56:	IO_PAGE_FAULT Event Log Buffer Entry Format	149
Figure 57:	DEV_TAB_HARDWARE_ERROR Event Log Buffer Entry Format	152
Figure 58:	PAGE_TAB_HARDWARE_ERROR Event Log Buffer Entry Format	154
Figure 59:	ILLEGAL_COMMAND_ERROR Event Log Buffer Entry Format	156
Figure 60:	COMMAND_HARDWARE_ERROR Event Log Buffer Entry Format	156
Figure 61:	IOTLB_INV_TIMEOUT Event Log Buffer Entry Format	157
Figure 62:	INVALID_DEVICE_REQUEST Event Log Buffer Entry Format	159
Figure 63:	INVALID_PPR_REQUEST Event Log Buffer Entry Format, RX = 0	160
Figure 64:	INVALID_PPR_REQUEST Event Log Buffer Entry Format, RX = 1	161
Figure 65:	EVENT_COUNTER_ZERO Event Log Buffer Entry Format	162
Figure 66:	GUEST_EVENT_FAULT Event Buffer Entry Format	163

Figure 67:	VIOMMU_HARDWARE_ERROR Event Entry Format	164
Figure 68:	RMP_PAGE_FAULT Event Log Buffer Entry Format	166
Figure 69:	RMP_HARDWARE_ERROR Event Log Buffer Entry Format	168
Figure 70:	Translation and Remapping Validation Sequence	170
Figure 71:	Peripheral Page Request Log in System Memory	173
Figure 72:	PPR Log State Diagram	176
Figure 73:	Generic Peripheral Page Request Log Buffer Entry Format	176
Figure 74:	PAGE_SERVICE_REQUEST PPR Log Buffer Entry Format	177
Figure 75:	Guest vAPIC Log in System Memory	181
Figure 76:	Guest Virtual APIC Log State Diagram	182
Figure 77:	Generic Guest Virtual APIC Log Buffer Entry Format	184
Figure 78:	GA_GUEST_NR Log Buffer Entry Format	184
Figure 79:	IOMMU Private Address Map	188
Figure 80:	IOMMU Virtual Function Control MMIO and IOMMU Virtual Function MMIO	190
Figure 81:	Extended Interrupt Remapping Table	191
Figure 82:	IOMMU Counter Register Address Decode	255
Figure 83:	IOMMU in a Tunnel	273
Figure 84:	IOMMU in a Peripheral Bus Bridge	273
Figure 85:	Hybrid IOMMU	274
Figure 86:	Chained Hybrid IOMMU in a Large System	274
Figure 87:	Example Platform Architecture	277
Figure 88:	IVHD Type 10h IOMMU Feature Reporting Field Format	285

Tables

Table 1:	Bit Attribute Definitions	28
Table 2:	Software-Visible Features.	39
Table 3:	Special Address Controls (GPA)	51
Table 4:	System Management Interrupt Address Fields.	56
Table 5:	Feature Enablement for Address Translation	62
Table 6:	Feature Enablement for Interrupt Remapping and Virtualization	62
Table 7:	Device Table Entry (DTE) Field Definitions	64
Table 8:	V, TV, and GV Fields in Device Table Entry	72
Table 9:	IV and IntCtl Fields in Device Table Entry for Fixed and Arbitrated Interrupts	72
Table 10:	IV and Pass Fields in Device Table Entry for Selected Interrupts	73
Table 11:	GLX and Maximum Translatable PASID size	73
Table 12:	Cache bit and U bit for ATS requests.	74
Table 13:	Registers Utilized to Allocate Device Table Segments	76
Table 14:	Example Page Size Encodings	78
Table 15:	Page Table Level Parameters	80
Table 16:	I/O Page Table Entry Not Present Fields, PR=0.	80
Table 17:	I/O Page Translation Entry (PTE) Fields, PR=1.	81
Table 18:	I/O Page Directory Entry (PDE) Fields, PR=1	83
Table 19:	IOMMU Controls and Actions for Upstream Interrupts	88
Table 20:	Interrupt Remapping Table Fields - Basic Format	89
Table 21:	Interrupt Virtualization Controls for Upstream Interrupts	91
Table 22:	IRTE Field Descriptions with Guest Virtual APIC, IRTE[GuestMode]=0	92
Table 23:	IRTE Field Descriptions with Guest Virtual APIC, IRTE[GuestMode]=1	94
Table 24:	Guest Address Translation Controls.	97
Table 25:	AMD64 Guest CR3 Level-1 Table Format	99
Table 26:	AMD64 GCR3 Base Pointer Entry Fields	99
Table 27:	Guest CR3 Level-2 Table Format.	101
Table 28:	Guest CR3 Level-2 Base Table Pointer Fields.	101
Table 29:	IOMMU Interpretation of AMD64 Page Table Fields for 4-Kbyte Page Translation	104
Table 30:	IOMMU Interpretation of AMD64 Page Table Fields for 2-Mbyte Page Translation.	106
Table 31:	IOMMU Interpretation of AMD64 Long Mode 1-Gbyte Page Table Fields	109
Table 32:	AMD64 Access Privilege Conversion Table for ATS Request	114

Table 33: PCIe® TLP Prefix Payload Fields116

Table 34: COMPLETION_WAIT Fields122

Table 35: INVALIDATE_DEV_TAB_ENTRY Fields123

Table 36: INVALIDATE_IOMMU_PAGES Fields125

Table 37: INVALIDATE_IOTLB_PAGES Fields.....126

Table 38: INVALIDATE_INTERRUPT_TABLE command Fields129

Table 39: PREFETCH_IOMMU_PAGES Fields.....130

Table 40: COMPLETE_PPR_REQUEST Fields132

Table 41: INVALIDATE_IOMMU_ALL Fields134

Table 42: Event Type Summary140

Table 43: ILLEGAL_DEV_TABLE_ENTRY Event Types141

Table 44: IO_PAGE_FAULT Event Types142

Table 45: DEV_TAB_HARDWARE_ERROR Event Types.....143

Table 46: PAGE_TAB_HARDWARE_ERROR Event Types144

Table 47: COMMAND_HARDWARE_ERROR Event Types144

Table 48: ILLEGAL_COMMAND_ERROR Event Types144

Table 49: IOTLB_INV_TIMEOUT Event Types145

Table 50: INVALID_DEVICE_REQUEST Event Types (Access).....145

Table 51: INVALID_DEVICE_REQUEST Event Types (Translation Request)146

Table 52: INVALID_PPR_REQUEST Event Summary146

Table 53: EVENT_COUNTER_ZERO Event Types.....146

Table 54: RMP_PAGE_FAULT Event Types147

Table 55: RMP_HARDWARE_ERROR Event Types147

Table 56: ILLEGAL_DEV_TABLE_ENTRY Event Log Buffer Entry Fields147

Table 57: IO_PAGE_FAULT Event Log Buffer Entry Fields.....149

Table 58: Event Log Type Field Encodings151

Table 59: DEV_TAB_HARDWARE_ERROR Event Log Buffer Entry Fields152

Table 60: PAGE_TAB_HARDWARE_ERROR Event Log Buffer Entry Fields154

Table 61: ILLEGAL_COMMAND_ERROR Event Log Buffer Entry Fields.....156

Table 62: COMMAND_HARDWARE_ERROR Event Log Buffer Entry Fields.....157

Table 63: IOTLB_INV_TIMEOUT Event Log Buffer Entry Fields158

Table 64: INVALID_DEVICE_REQUEST Type Field Encodings.....158

Table 65: INVALID_DEVICE_REQUEST Event Log Buffer Entry Fields.....159

Table 66: INVALID_PPR_REQUEST Event Log Buffer Entry Fields.....161

Table 67:	EVENT_COUNTER_ZERO Event Log Buffer Entry Fields	163
Table 68:	Guest_Event_Fault Event Log Buffer Entry Fields	163
Table 69:	VIOMMU_HARDWARE_ERROR Event Entry Fields	164
Table 70:	RMP_PAGE_FAULT Event Log Buffer Entry Fields.	166
Table 71:	RMP_HARDWARE_ERROR Event Log Buffer Entry Fields	168
Table 72:	DualEventLogSup Field Capability Levels	171
Table 73:	DualEventLogEn Field Operation Levels.	172
Table 74:	PAGE_SERVICE_REQUEST PPR Log Buffer Entry Fields	177
Table 75:	GA_GUEST_NR Log Buffer Entry Fields.	185
Table 76:	Pinned Memory Buffer Regions.	189
Table 77:	SMI Filter Register MMIO Offset Assignments	222
Table 78:	Device Table Segment Base Address Registers; Offsets and Maximum Size Value.	227
Table 79:	MARC Aperture Register Offsets (hexadecimal).	238
Table 80:	Counter Bank Addressing (MMIO)	255
Table 81:	Architectural Counter Input Group, CAC = 0b	258
Table 82:	I/O Virtualization Reporting Structure (IVRS)	279
Table 83:	IVRS Fields.	280
Table 84:	IVRS Revision Field.	280
Table 85:	IVRS IVinfo Field	281
Table 86:	I/O Virtualization Hardware Definition (IVHD) Block Generic Format	282
Table 87:	I/O Virtualization Hardware Definition (IVHD) Type 10h	284
Table 88:	IVHD Type 10h Field Definitions	284
Table 89:	IVHD Flags Field	285
Table 90:	IVHD IOMMU Info Field	285
Table 91:	IVHD IOMMU Feature Reporting Field	285
Table 92:	I/O Virtualization Hardware Definition (IVHD) Type 11h	287
Table 93:	IVHD Type 11h Field Definitions	287
Table 94:	IVHD Flags Field	288
Table 95:	IVHD Type 11h IOMMU Attributes	288
Table 96:	I/O Virtualization Hardware Definition (IVHD) Type 40h Fields.	289
Table 97:	IVHD Type 40h Field Definitions	289
Table 98:	IVHD Type 40 Flags Field	290
Table 99:	IVHD Type 40h IOMMU Attributes	290
Table 100:	IVHD Device Entry Length Based on Type.	291

Table 101:	IVHD Device Entry Fields (4-byte)	291
Table 102:	IVHD Device Entry Type Codes (4-byte)	291
Table 103:	IVHD Device Table Entry DTE Setting	292
Table 104:	IVHD Device Entry Type Codes (8-byte)	293
Table 105:	IVHD Device Entry Extended DTE Setting Field	294
Table 106:	IVHD Special Device Entry Variety Field	294
Table 107:	Device Entry Type F0h Fields	295
Table 108:	IVMD Types 20h–22h Format	296
Table 109:	IVMD Types 20h–22h Fields	296
Table 110:	IVMD Flags Definitions	297

Revision History

Date	Revision	Description
October 2022	3.07	<ul style="list-style-type: none"> • Updated “Related Documents” on page 28. <p>Section 1:</p> <ul style="list-style-type: none"> • Added features to Table 2. <p>Section 2:</p> <ul style="list-style-type: none"> • Updated Figure 7, “Device Table Entry (DTE) Fields” on page 63. • Updated Table 7, “Device Table Entry (DTE) Field Definitions” on page 64. • Updated bit 5 in Figure 18, “IRTE Fields with Guest Virtual APIC, IRTE[GuestMode]=1” on page 93 and Table 23, “IRTE Field Descriptions with Guest Virtual APIC, IRTE[GuestMode]=1” on page 94. • Updated bit 5 in Figure 20, “IRTE Fields with Guest Virtual APIC, IRTE[GuestMode]=1” on page 96. • Added Section 2.2.5.4, “Guest APIC Physical Processor Interrupt” on page 96. • Updated Section 2.2.6.3, “Guest CR3 Table” on page 98, including Figure 21, Figure 23. • Added Section 2.2.6.4, “Support for AMD64 Level 5 (PML5E) Page Table” on page 102. • Updated Section 2.2.6.5, “AMD64 4-Kbyte Page Translation” on page 102 for PML5E, including Figure 25, added Figure 26, and Table 29. • Updated Section 2.2.6.6, “AMD64 2-Mbyte Page Translation” on page 105 for PML5E, including Figure 31, added Figure 32, and Table 30. • Updated Section 2.2.6.7, “AMD64 1-Gbyte Page Translation” on page 107 for PML5E, including Figure 36, added Figure 37, and Table 31. • Updated Figure 40, “Complete GVA-to-SPA Address Translation” on page 110. • Updated Section 2.10.1.1, “vIOMMU Backing Storage Memory” on page 188. • Updated Section 2.12.2.4, “SEV-SNP Page Mode Restrictions” on page 193. <p>Section 3:</p> <ul style="list-style-type: none"> • In Capability Offset 10h, updated bit description for Bits 7:5. • In MMIO Offset 0018h, updated Bits 60, 58, and 55. • In MMIO Offset 0030h, updated Bits 13:12 and 5. • Updated MMIO Offset 01A0h. • Added VFCntIMMIO Offset {16'b[GuestID], 6'b01_1000}. • Updated VFCntIMMIO Offset {16'b[GuestID], 6'b10_0000}. • Updated VFCntIMMIO Offset {16'b[GuestID], 6'b10_1000}. • Updated VFCntIMMIO Offset {16'b[GuestID], 6'b11_0000}. • Added VFCntIMMIO Offset {16'b[GuestID], 6'b11_1000}. <p>Section 5:</p> <ul style="list-style-type: none"> • Updated Table 108, “IVMD Types 20h–22h Format” on page 296. • Updated Table 109, “IVMD Types 20h–22h Fields” on page 296.

Date	Revision	Description
March 2021	3.06	<p>Added terms in “Definitions” on page 22. Added items to “Related Documents” on page 28.</p> <p>Section 1:</p> <ul style="list-style-type: none"> • Updated Figure 1, “Example Platform Architecture” on page 33. • Updated Section 1.3, “IOMMU Optional Features” on page 37. • Added rows to Table 2, “Software-Visible Features” on page 39 and a new column to indicate specification rev level (replacing Table 2, “Feature Support by Specification Rev Level.” • Added Section 1.3.12, “Hardware Accelerated Virtualized IOMMU (vIOMMU)” on page 46. • Added Section 1.3.13, “Secure Nested Paging (SEV-SNP)” on page 47. <p>Section 2:</p> <ul style="list-style-type: none"> • Updated Figure 4, “IOMMU Data Structures” on page 59. • Updated Figure 7, “Device Table Entry (DTE) Fields” on page 63. • Updated Table 7, “Device Table Entry (DTE) Field Definitions” on page 64. • Updated Figure 18, “IRTE Fields with Guest Virtual APIC, IRTE[GuestMode]=1” on page 93. • Updated Table 23, “IRTE Field Descriptions with Guest Virtual APIC, IRTE[GuestMode]=1” on page 94. • Updated Section 2.4.8, “INVALIDATE_IOMMU_ALL” on page 133. • Added Section 2.4.9, “INSERT_GUEST_EVENT Command” on page 134. • Added Section 2.4.9, “RESET_VMMIO Command” on page 135. • Added Table 54, “RMP_PAGE_FAULT Event Types” on page 147. • Added Table 55, “RMP_HARDWARE_ERROR Event Types” on page 147. • Updated Figure 55, “ILLEGAL_DEV_TABLE_ENTRY Event Log Buffer Entry Format” on page 147. • Updated Table 56, “ILLEGAL_DEV_TABLE_ENTRY Event Log Buffer Entry Fields” on page 147. • Updated Figure 56, “IO_PAGE_FAULT Event Log Buffer Entry Format” on page 149. • Updated Table 57, “IO_PAGE_FAULT Event Log Buffer Entry Fields” on page 149. • Updated Table 58, “Event Log Type Field Encodings” on page 151. • Added Figure 57, “DEV_TAB_HARDWARE_ERROR Event Log Buffer Entry Format” on page 152. • Updated Table 59, “DEV_TAB_HARDWARE_ERROR Event Log Buffer Entry Fields” on page 152. • Updated Figure 58, “PAGE_TAB_HARDWARE_ERROR Event Log Buffer Entry Format” on page 154. • Updated Table 60, “PAGE_TAB_HARDWARE_ERROR Event Log Buffer Entry Fields” on page 154. • Added Section 2.5.13, “VIOMMU_HARDWARE_ERROR Event” on page 164. • Added Section 2.5.14, “RMP_PAGE_FAULT Event” on page 165. • Added Section 2.5.15, “RMP_HARDWARE_ERROR Event” on page 167. • Added Section 2.10, “vIOMMU” on page 187. • Added Section 2.11, “Secure ATS Support” on page 192. • Added Section 2.12, “IOMMU Secure Nested Paging (SEV-SNP) Support” on page 192.

Date	Revision	Description
March 2021	3.06	<p>(continued)</p> <p>Section 2:</p> <ul style="list-style-type: none"> • Updated Figure 4, “IOMMU Data Structures” on page 59. • Updated Figure 7, “Device Table Entry (DTE) Fields” on page 63. • Updated Table 7, “Device Table Entry (DTE) Field Definitions” on page 64. • Updated Figure 18, “IRTE Fields with Guest Virtual APIC, IRTE[GuestMode]=1” on page 93. • Updated Table 23, “IRTE Field Descriptions with Guest Virtual APIC, IRTE[GuestMode]=1” on page 94. • Updated Section 2.4.8, “INVALIDATE_IOMMU_ALL” on page 133. • Added Section 2.4.9, “INSERT_GUEST_EVENT Command” on page 134. • Added Section 2.4.9, “RESET_VMMIO Command” on page 135. • Added Table 54, “RMP_PAGE_FAULT Event Types” on page 147. • Added Table 55, “RMP_HARDWARE_ERROR Event Types” on page 147. • Updated Figure 55, “ILLEGAL_DEV_TABLE_ENTRY Event Log Buffer Entry Format” on page 147. • Updated Table 56, “ILLEGAL_DEV_TABLE_ENTRY Event Log Buffer Entry Fields” on page 147. • Updated Figure 56, “IO_PAGE_FAULT Event Log Buffer Entry Format” on page 149. • Updated Table 57, “IO_PAGE_FAULT Event Log Buffer Entry Fields” on page 149. • Updated Table 58, “Event Log Type Field Encodings” on page 151. • Added Figure 57, “DEV_TAB_HARDWARE_ERROR Event Log Buffer Entry Format” on page 152. • Updated Table 59, “DEV_TAB_HARDWARE_ERROR Event Log Buffer Entry Fields” on page 152. • Updated Figure 58, “PAGE_TAB_HARDWARE_ERROR Event Log Buffer Entry Format” on page 154. • Updated Table 60, “PAGE_TAB_HARDWARE_ERROR Event Log Buffer Entry Fields” on page 154. • Added Section 2.5.13, “VIOMMU_HARDWARE_ERROR Event” on page 164. • Added Section 2.5.14, “RMP_PAGE_FAULT Event” on page 165. • Added Section 2.5.15, “RMP_HARDWARE_ERROR Event” on page 167. • Added Section 2.10, “vIOMMU” on page 187. • Added Section 2.11, “Secure ATS Support” on page 192. • Added Section 2.12, “IOMMU Secure Nested Paging (SEV-SNP) Support” on page 192. <p>(continued)</p>

Date	Revision	Description
March 2021	3.06	(continued) Section 3: <ul style="list-style-type: none"> • Added Section 3.3, “IOMMU Vendor Specific Capability Block Registers” on page 201. • Updated MMIO Offset 0018h, “IOMMU Control Register” on page 207. • Updated MMIO Offset 0020h, “IOMMU Exclusion Base Register / Completion Store Base Register” on page 213. • Updated MMIO Offset 0028h, “IOMMU Exclusion Range Limit Register / Completion Store Limit Register” on page 214. • Updated MMIO Offset 0030h, “IOMMU Extended Feature Register” on page 215. • Added MMIO Offset 0x190h, “vIOMMU Status Register” on page 237. • Added MMIO Offset 01A0h, “IOMMU Extended Feature 2 Register” on page 240. • Added Section 3.5, “IOMMU Virtual Function Controls MMIO Registers” on page 263. • Added Section 3.6, “IOMMU Virtual Function MMIO Registers” on page 268. Section 5: <ul style="list-style-type: none"> • Updated Table 92, “I/O Virtualization Hardware Definition (IVHD) Type 11h” on page 287 (added EFR Register Image 2). • Updated Table 93, “IVHD Type 11h Field Definitions” on page 287 (added EFR Register Image 2). • Updated Table 97, “IVHD Type 40h Field Definitions” on page 289 (added EFR Register Image 2).
January 2020	3.05	Incorporated updates in Chapters 1-5.
December 2016	3.00	2nd Public Release
January 2015	2.62	Public Release

Preface

About this Document

This document describes AMD I/O Virtualization Technology. AMD I/O Virtualization Technology is embodied in the system-level function called the I/O Memory Management Unit (IOMMU).

Intended Audience

This document provides the IOMMU behavioral definition and associated design notes. It is intended for the use of system designers, chipset designers and programmers involved in the development of OS kernel software and drivers, Hypervisors and Firmware for AMD products using the x86/AMD64 microprocessor architecture. The intended user should have previous experience in personal computer design and the system architecture of the AMD target platform. See [“Related Documents”](#) on [page 28](#) for a list of references.

Organization

- [Chapter 1 “IOMMU Overview”](#) on [page 31](#) provides an introduction to AMD I/O Virtualization Technology and the IOMMU.
- [Chapter 2 “Architecture”](#) on [page 49](#) describes the operation of the IOMMU and the registers and system memory data structures that control its behavior.
- [Chapter 3 “Registers”](#) on [page 195](#) shows the format of the IOMMU registers and describes the data fields within each register.
- [Chapter 4 “Implementation Considerations”](#) on [page 271](#) discusses design and implementation issues that are primarily of concern to IOMMU implementers.
- [Chapter 5 “I/O Virtualization ACPI Table”](#) on [page 277](#) defines the ACPI tables used to describe the platform configuration information for IOMMU control fields.
- The appendix [“Index to Registers”](#) on [page 299](#) provides an index to all the IOMMU register definitions.

Conventions and Definitions

Notation

- 128
Numbers without an alpha suffix are decimal unless the context indicates otherwise.
- 1011b
A binary value—in this example, a 4-bit value.
- F0EA_0B02h
A hexadecimal value. Underscore characters may be inserted to improve readability.
- CR0–CR4
A register range, from register CR0 through CR4, inclusive, with the low-order register first.
- CR0[PE]
Notation for referring to a field within a register—in this case, the PE field of the CR0 register.
- 7:4
A bit range, from bit 7 to 4, inclusive. The high-order bit is shown first. Commas may be inserted to indicate gaps.

Definitions

- **Accessed bit (A).** A bit in the page table that indicates the corresponding memory has been read or written. Usually set to 1 by hardware.
- **ACPI.** Advanced Configuration and Power Interface, a specification of industry-standard interfaces enabling OS-directed configuration and other management.
- **APIC.** Advanced programmable interrupt controller (see specifications under the model numbers 82093AA and 82489DX).
- **ARI.** Alternative Routing Information is a PCI-SIG specification that allows a PCI Device to have more than eight PCI Functions but no more than 256.
- **ATS.** Address translation service, a PCI-SIG specification, allows a PCI peripheral to request virtual-to-physical address translation from an IOMMU or TA. The resulting translation may be stored in an IOTLB. ATS is optional on a peripheral. This specification requires the *Address Translation Services 1.1 Specification* or later. See <http://www.pcisig.com/specifications/iov/ats/>.
- **AVIC.** The AMD Advanced Virtual Interrupt Controller. See “*Advanced Virtual Interrupt Controller*” in *AMD64 Architecture Programmer’s Manual, Volume 2: System Programming*, order #24593 (APM2), Chapter 15. AVIC is an implementation of a guest virtual APIC. Allows the processor and the IOMMU to coordinate the delivery of interrupts directly to running guest VMs.
- **BAR.** PCI-defined base address register.
- **BDF.** PCI bus I/O device identifier; concatenation of the bus, device, and function numbers. Also called DeviceID within this document.
- **BIOS.** Refers to the platform firmware (Basic Input/Output Services). See also, UEFI.

- **Bounce Buffer.** A buffer located in low system memory for DMA traffic from devices that do not support 64-bit addressing. The OS copies the DMA data to or from the buffer to the real buffer in high memory used by the driver.
- **Cold Reset.** A reset generated by removing and reapplying power to the device.
- **Dirty bit (D).** A bit in the page table that indicates the corresponding memory has been written. Usually set to 1 by hardware.
- **Device Exclusion Vector (DEV).** Contiguous arrays of bits in physical memory. Each bit in the DEV table represents a 4KB page of physical memory (including system memory and MMIO). The DEV table is packed as follows: bit[0] of byte 0 controls the first 4 Kbytes of physical memory; bit[1] of byte 0 controls the second 4 Kbytes of physical memory; etc.
- **DeviceID.** A 16 bit device identification number consisting of the Bus number, Device number and Function number, also named BDF or BDFID. Used by an IOMMU to select the nested mapping tables for an address translation or interrupt remapping operation.
- **Device Processing Complex.** A computational unit on the peripheral such as a dedicated function (e.g., NIC, encryption engine), a graphics processing unit (GPU), or an accelerated computing element (AC)
- **Device Table.** A table in system memory that maps DeviceIDs to DomainIDs and page table root pointers.
- **Device Table Entry (DTE).** An entry in the Device Table.
- **Direct Memory Access (DMA).** A feature that enables a peripheral to access memory without intervention by the central processor.
- **Device Virtual Address (DVA).** The untranslated address emitted by a device in a DMA transaction. This address can correspond to the system physical address if the device is excluded from translation by the IOMMU or to the GPA if the device is owned and programmed by a guest operating system.
- **Domain.** See Protection Domain.
- **DomainID.** A 16-bit number chosen by software to identify a domain.
- **Downstream.** Traffic going from the Root Complex to the device Endpoint.
- **GART.** Graphics Address Remapping Table.
- **GPU.** Graphical processing unit, usually used for graphics-specific computation.
- **GPGPU.** A GPU used for general-purpose computation.
- **Guest.** An application or OS run by the host in its own virtual environment.
- **Guest address translation.** Translation for GVA to GPA. May be serviced by an IOMMU or by a private MMU on the peripheral.
- **Guest Physical Address (GPA).** The x86-canonical virtual address used by a guest operating system in a VM. A GPA is created by using the guest page tables to translate a guest virtual address. The GPA may be further translated to a System Physical Address.
- **Guest Virtual Address (GVA).** The virtual addresses used by a guest application. A GVA may be translated into a Guest Physical Address. Guest virtual addresses are treated as canonical x86

addresses.

- **Guest Virtual APIC.** Optionally the IOMMU can support the delivery of interrupts to guest VMs without hypervisor intervention. The guest APIC is described in the *AMD Virtual Interrupt Controller Specification, Revision 1.0* or newer.
- **Host Data Path (HDP).** A functional unit that can convert CPU linear addressing to GPU-style tiled or rectangular addressing for improved performance. Often found in advanced graphics processing peripherals.
- **High memory.** In the x86 platform architecture, system memory located at an address equal to or greater than 4 Gbytes.
- **Host.** The system software layer responsible for running guests. See also Nested paging and Nested address translation.
- **Host Physical Address (HPA).** The Host Physical Address is the physical address the Host system hardware uses to access a physical resource (memory or MMIO register). The Host Physical Address range is typically managed by an Operating System or a Hypervisor in virtualized environments and in most systems identical with the System Physical Address.
- **Hypervisor.** A Hypervisor (HV) is the controlling software for a computer. It manages the physical hardware and VMs to allow multiple operating systems to run concurrently on a computer system.
- **IOMMU.** Refers to the I/O Memory Management Unit defined by this specification.
- **IOTLB.** I/O Translation Look-aside Buffer. A buffer located in a peripheral device that holds a pretranslated address. Sometimes called a “remote IOTLB.” An example of an IOTLB is the PCIe[®] Address Translation Cache.
- **IRTE.** Interrupt Remapping Table Entry
- **IVHD.** I/O Virtualization Hardware Definition block, an ACPI table defined in [Section 5.2.2.1 \[I/O Virtualization Hardware Definition \(IVHD\) Block\]](#).
- **IVMD.** I/O Virtualization Memory Definition block, an ACPI table defined in [Section 5.2.2.2 \[I/O Virtualization Memory Definition \(IVMD\) Block\]](#).
- **IVRS.** I/O Virtualization Reporting Structure block, an ACPI table defined in [Section 5.2 \[I/O Virtualization Reporting Structure \(IVRS\)\]](#).
- **LMA.** Local Memory Address; corresponds to the physical address space used on the peripheral to access on-board or private memory. In some peripherals, aperture hardware maps some or all of the local memory address space into the system physical address space. The aperture hardware is usually managed by a device driver in an operating system.
- **Local Memory.** Memory on the peripheral that is typically accessed more quickly than system memory and is usually not coherent with system memory. Part of the local memory may be addressable from the CPU (called “public”) and part may be inaccessible from the CPU (called “private”). An aperture mechanism is commonly used to select the portion of local memory that is public.
- **Local Memory Protection Map.** A hardware component that enforces the separation of virtual machine contexts within the local memory of a peripheral.

- **Low memory.** In the x86 platform architecture, system memory located below 4 Gbytes.
- **Master-Abort.** A PCI termination mechanism that allows a master to terminate a transaction when no target responds.
- **Memory Address Routing Controls (MARC).** MARC is a system that specifies a defined aperture for a guest assigned real-time capable device with low-latency access requirements to a dedicated physical memory range that is under control of the Hypervisor. Examples for guest-assigned devices that require a low-latency access path to system memory are display scanout engines or framebuffer capture devices.
- **MMIO.** Memory Mapped I/O. Read or write access to memory mapped resources provided by devices.
- **MMU.** Memory Management Unit.
- **Message Signalled Interrupt (MSI).** An interrupt that is signalled by generating a posted write to a system-defined physical address.
- **Nested address translation.** Translation for GPA to SPA. May be serviced directly by an IOMMU or by a remote IOTLB. Use of an IOTLB requires ATS and/or PRI.
- **Nested paging.** An optional feature in AMD64 processors, the nested paging feature provides for two levels of address translation, thus eliminating the need for the virtual machine manager to maintain shadow page tables. See *AMD64 Architecture Programmer's Manual, Volume 2: System Programming*, order #24593 (APM2).
- **NW.** A PCI-SIG term (bit) used to signal lack of intent to perform write operations.
- **NX: No-execute.** Page table entry (PTE) field indicating that program code should not be executed from the referenced page.
- **Page Tables.** A table structure in main memory used to translate an address from one representation to an alternate representation.
- **PASID.** The Process Address Space ID used to identify the application address space within a x86-canonical guest virtual machine. It is used on a peripheral to isolate concurrent contexts residing in shared local memory. Together, PASID and DeviceID uniquely identify an application address space. See PASID TLP prefix.
- **PASID TLP prefix.** The IOMMU requires that a virtual address with a PASID carry the PASID value using the PASID TLP prefix. See also PASID and TLP. See the PCI-SIG PASID TLP Prefix ECN specification.
- **PCI, PCI-SIG, PCIe[®], PCI-X[®].** The PCI-SIG is an industry standards body that defines I/O connection technology, including PCI, PCI-X, and PCIe. See <http://www.pcisig.com/home> for more information.
- **PDE.** Page directory entry for address translation (see example in [Figure 10 on page 82](#)).
- **Pinned memory.** Memory pages that are to be maintained in physical memory all the time. Pinning a memory page prevents the page management software from using it for other purposes. A memory page must typically be pinned before DMA starts and may be unpinned when DMA completes.

- **Platform firmware.** The firmware or software that controls startup and configuration of the platform. Platform firmware is commonly implemented as BIOS or UEFI.
- **Platform Security Processor (PSP).** Also referred to as AMD Secure Processor (AMD-SP). Exposes a set of functions to the hypervisor for guest lifecycle management of SEV and SNP-enabled guests.
- **PPR.** Peripheral Page Request. When the IOMMU receives a valid PRI request, it creates a PPR message to request changes to the virtual address space.
- **PR, P.** Present. Page table entry (PTE) field indicating that the page table or physical page pointed to is currently loaded in system memory.
- **Pretranslated address.** An address that has been translated to an SPA by a peripheral with an IOTLB.
- **Page Request Interface (PRI).** The Page Request Interface is a PCI-SIG specification that defines how a peripheral requests memory management services from a host OS or hypervisor (e.g., page fault service for the peripheral). PRI is optional on a peripheral, but if PRI is implemented, ATS is required.
- **Private MMU, Device MMU, or Device Page Tables.** A peripheral-specific mechanism to translate addresses generated on the peripheral. In the simplest case, it generates a single bit to indicate the input address is an access to peripheral local memory or to system memory. When present, the private MMU, Device MMU, or Device Page Tables provides guest address translation. On a GPU, a private MMU, Device MMU, or Device Page Tables is often referred to as the VM component of the memory controller.
- **Protection Domain.** A set of address mappings and access rights that can be shared by multiple devices.
- **PSP.** See Platform Security Processor.
- **PTE.** Page Table Entry. A page table translation entry controls virtual-to-physical address translation and memory page access (see example in [Figure 9 on page 80](#)).
- **Reserved.** A register field designated as *reserved* requires special handling by software. Reserved fields in writable registers must be written with all zeros. When read, software cannot rely on the value returned.
- **Reverse Map Table (RMP).** An SEV-SNP data structure used to support additional security checks on memory accesses. For more details, refer to “Secure Nested Paging (SEV-SNP)” in *AMD64 Architecture Programmer’s Manual, Volume 2: System Programming*, order #24593 (APM2).
- **Secure Encrypted Virtualization (SEV).** A feature that allows the memory contents of a virtual machine (VM) to be transparently encrypted with a key unique to the VM.
- **Secure Nested Paging (SEV-SNP).** SNP provides integrity protection of VM memory to help prevent hypervisor-based attacks that rely on guest data corruption, aliasing, replay, and various other attack vectors.
- **System Physical Address (SPA).** The address directly used to address system memory. Under SVM, this is also known as the host physical address. See HPA.

- **System software.** Privileged software that manages the hardware resources of a system and controls access to these resources by lesser privileged software. In a non-virtualized environment, the operating system is system software. In a virtualized environment, the hypervisor (HV) is system software.
- **TA.** Translation Agent is a PCI-SIG term to refer to the IOMMU table walker.
- **Target-Abort.** A PCI termination mechanism that allows a target to terminate a transaction in which a fatal error has occurred, or to which the target will never be able to respond.
- **TLB.** Translation Look-aside Buffer is a cache of address translation information usually implemented within an MMU to improve translation speed.
- **TLP.** Transaction Layer Packet is a PCIe term for non-control packets. The TLP packet may have a prefix.
- **UEFI.** Refers to the “Unified Extensible Firmware Interface” specification for platform firmware. See <http://www.uefi.org/home/> . See also BIOS.
- **Untranslated address.** A virtual address (GVA or GPA) issued by a peripheral that will be translated to an SPA by the IOMMU. The handling of an untranslated address on a peripheral is outside the scope of this specification.
- **Upstream.** Traffic going from the device Endpoint to the Root Complex.
- **User, U/S, User/Supervisor level.** The IOMMU can provide privilege-level information to a peripheral. The value 0b means supervisor level access is allowed, but user level is not; 1b means user and supervisor access are allowed. The terms User and U/S are used, depending on the context.
- **VM.** A virtual machine is created and managed by a hypervisor so that multiple virtual machines can share a single hardware system and run independent operating system instances.

Bit Attributes

All bit attributes used in this specification are defined in [Table 1](#). These attributes apply to register definitions, Device Table entries, page table entries, Command Buffer entries and Event Log entries.

Table 1: Bit Attribute Definitions

Attribute	Description
HwInit	Hardware Initialized: Register fields are initialized by firmware or hardware mechanisms such as pin strapping or serial EEPROM. Fields are read-only after initialization and can only be reset (or write-once by firmware) with a cold reset.
Ignored Ign	Ignored or Ign: For an IOMMU register, the state of the field is ignored by the IOMMU, writes may be discarded and reads return undefined results. For a memory location, the contents of the field is ignored by the IOMMU when read, but the value is preserved when the memory location is written by the IOMMU. Note that some ignored fields may be used by other system components (e.g., a memory field in a page table entry that is ignored by the IOMMU may be used by the processor).
RO	Read-only register: Register fields are read-only and cannot be altered by software.
RW	Read-Write register: Register fields are read-write and may be either set or cleared by software to the desired state.
RW1C	Read-only status, Write-1-to-clear status register: Register bits indicate status when read, a set bit indicating a status event may be cleared by writing a 1. Writing a 0 to RW1C bits has no effect.
RW1S	Write-1-to-set register: Register bits indicate status of an operation when read, setting the bit initiates the operation. Hardware clears the bit when the operation completes. Writing a 0 to RW1S bits has no effect.
Reserved Resv Res	Reserved, Resv, or Res: Reserved for future implementations. Reserved fields in a register must be implemented as read-only zero. Reserved fields in a memory location must be zero.
Unused Un	Unused or Un: Field is not used by hardware. Software is allowed to use the field for its own purposes.

Related Documents

- *AMD64 Architecture Programmer's Manual, Volume 1: Application Programming*, order# 24592 (APM1)
- *AMD64 Architecture Programmer's Manual, Volume 2: System Programming*, order# 24593 (APM2)
- *AMD64 Architecture Programmer's Manual, Volume 3: General-Purpose and System Instructions*, order# 24594 (APM3)
- *AMD64 Architecture Programmer's Manual, Volume 4: 128-Bit and 256-Bit Media Instructions*, order# 26568 (APM4)

- *AMD64 Architecture Programmer's Manual, Volume 5: 64-Bit Media and x87 Floating-Point Instructions*, order# 26569 (APM5)
- PCI Specification "PCI Express® Base Specification, Revision 5.0."
URL: <https://members.pcisig.com/wg/PCI-SIG/document/13005>
- Advanced Configuration and Power Interface Specification, Revision 6.3, January 2019.
URL: <https://uefi.org/specifications>
- *SEV Secure Nested Paging Firmware ABI Specification*, order# 56860
- SNP-WP: "AMD SEV-SNP: Strengthening VM Isolation with Integrity Protection and More," January, 2020. URL: <https://www.amd.com/system/files/TechDocs/SEV-SNP-strengthening-vm-isolation-with-integrity-protection-and-more.pdf>
- "Compute Express Link (CXL) Specification Revision 2.0."
URL: <https://www.computeexpresslink.org/>

1 IOMMU Overview

This chapter provides an overview of the capabilities of the IOMMU and presents several usage models. The detailed architecture of the IOMMU is discussed in Chapter 2, "Architecture".

The I/O Memory Management Unit (IOMMU) extends the AMD64 system architecture by adding support for address translation and system memory access protection on DMA transfers from peripheral devices. IOMMU also helps filter and remap interrupts from peripheral devices.

The IOMMU enables several significant system-level enhancements:

- Legacy 32-bit I/O device support on 64-bit systems (generally without requiring bounce buffers and expensive memory copies).
- More secure user-level application access to selected I/O devices.
- More secure virtual machine guest operating system access to selected I/O devices.

The IOMMU can be used to:

- Replace the existing Graphics Address Remapping Table (GART) mechanism.
- Remap addresses above 4GB for I/O devices that do not support 64-bit addressing.
- Allow a guest OS running on a virtual machine to have direct, assigned control of a device.
- Provide page granularity control of device access to system memory.
- Allow a device direct access to user space I/O.
- Allow direct delivery of interrupts to a guest operating system.
- Filter and remap interrupts.
- Share process virtual address space with selected peripheral devices.
- Isolate/sandbox devices to prevent malicious DMA accessing security sensitive OS and user data in memory.
- Enforce OS security policies for data access

The IOMMU can be thought of as a generalization of two facilities included in the AMD64 architecture: the GART and the Device Exclusion Vector (DEV). The GART provides address translation of I/O device accesses to a small range of the system physical address space, and the DEV provides a limited degree of I/O device classification and memory protection. With appropriate software support, the IOMMU can emulate the capabilities of the GART or DEV.

IOMMU optionally provides the capability to remap peripheral interrupt vectors.

1.1 Summary of IOMMU Capabilities

The IOMMU extends the concept of protection domains (or domains, for short) first introduced with the AMD64 DEV. The IOMMU allows each I/O device in the system to be assigned to a specific domain and a distinct set of I/O page tables. When an I/O device attempts to read or write system

memory, the IOMMU intercepts the access, determines the domain to which the device has been assigned, and uses the TLB entries associated with that domain or the I/O page tables associated with that I/O device to determine whether the access is to be permitted as well as the actual location in system memory that is to be accessed.

The IOMMU may include optional support for remote IOTLBs. A trusted I/O device with IOTLB support can cooperate with the IOMMU to maintain its own cache of address translations. This creates a framework for creating scalable systems with an IOMMU in which I/O devices may have different usage models and working set sizes. IOTLB-capable I/O devices contain private TLBs tailored for their own needs, creating a scalable distributed system of TLBs. The performance of IOTLB-capable I/O devices is not limited by the number of TLB entries implemented in the IOMMU. A peripheral with an IOTLB may issue untranslated addresses or pretranslated addresses that are determined from IOTLB entries. Pretranslated addresses are not checked by the IOMMU except to validate that the peripheral has the IOTLB enable bit set ($I = 1$) in the corresponding Device Table Entry (see [Figure 7](#) and [Table 7](#)).

Major system resources provided by the IOMMU include:

- I/O DMA access permission checking and address translation using memory-based translation tables.
- Optional support for guest translation tables compatible with the AMD64 long mode page table format.
- A Device Table that allows I/O devices to be assigned to specific domains and contains pointers to the I/O devices' page tables.
- An interrupt remapping table which the IOMMU uses to provide permission checking and interrupt remapping for I/O device interrupts
- Optional AMD64 guest virtual APIC mechanism which the IOMMU uses to deliver interrupts to guest VMs.
- Memory-based queues for exchanging command and status information between the IOMMU and the system processor(s).
- Optional support for a peripheral page request (PPR) log.
- Features to mitigate PPR and Event Log overflow.
- Optional support for a hardware-based mechanism for allowing privileged I/O devices to directly access defining regions of system memory.

The IOMMU is similar to the processor's memory management unit, except that it provides address translation and page protection for direct memory accesses (DMA) by peripheral devices rather than memory accesses by the processor.

The IOMMU provides no direct indication to an I/O device of a failed translation when processing an untranslated posted request. This is in contrast to the page fault mechanism employed by CPU's MMU.

Systems supported by the IOMMU may consist of a number of processor and device nodes connected to each other by a data fabric such as AMD Infinity Fabric, Data Fabric links or other means. The

IOMMU can only process memory transactions that are routed through its node in the system fabric. In a system with multiple links and buses to I/O devices, multiple IOMMUs are required to ensure that each I/O link or bus has appropriate protection and translation applied. Figure 1 shows an example of a platform with two I/O interconnect trees. Note that an IOMMU is required in the root node of both trees. In this example, the IOMMU is implemented as part of the I/O Hub. Other implementations are possible assuming that they conform to the same topology.

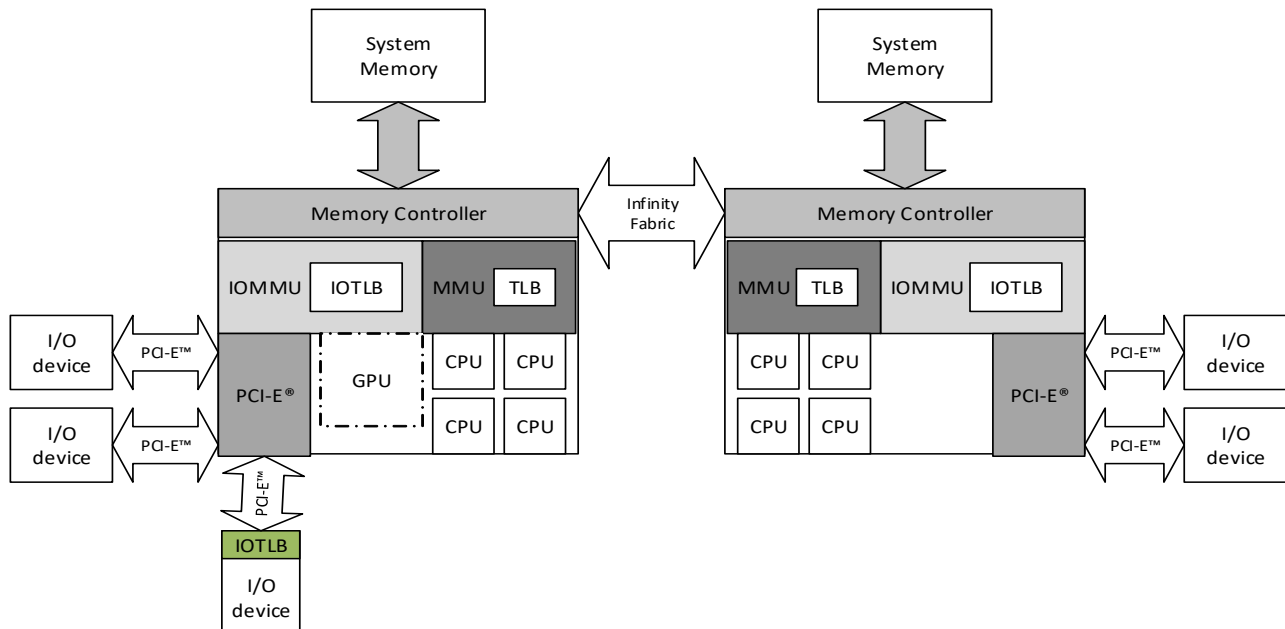

Figure 1: Example Platform Architecture

The IOMMU uses a command queue in memory (the Command Buffer) to accept explicit translation buffer invalidation commands initiated by system software.

Optionally the IOMMU may include support for peripheral page requests (PPR) for peripherals that use Address Translation Services (ATS). This creates a mechanism for peripherals and software to reduce the need for pinned pages during I/O. The IOMMU may include optional support for interrupt virtualization. This uses a virtualized guest APIC (one implementation of a guest APIC is the Advanced Virtual Interrupt Controller) with memory tables to deliver interrupts to guest VMs.

1.2 Usage Models

Seven models are discussed to highlight potential uses of the IOMMU in conventional and virtualized systems. These usage models can enhance system security and stability.

1.2.1 Replacing the GART

The GART is an AMD64 system facility that performs physical-to-physical translation of memory addresses within a graphics aperture. The GART was defined to allow complex graphical objects, such as texture maps, to appear to a graphics co-processor as if they were located in contiguous pages of memory, even though they are actually scattered across randomly allocated pages by most operat-

ing systems. The GART translates all accesses to the graphics aperture, including loads and stores executed by the host processor as well as memory reads and writes performed by I/O devices. Only accesses whose system physical addresses are within the GART aperture are translated; however, the results of the translation can be any system physical address.

To set up the equivalent translations for I/O device-initiated accesses, the host OS must:

- Construct I/O page tables that specify the desired translations.
- Make an entry in the Device Table pointing to the newly constructed I/O page tables.
- Notify the IOMMU of the newly updated Device Table entry.

At this point, all accesses by both the host processor and the graphics device are mapped to the same pages as they would have been by the GART.

If the host OS changes the page protection or translation, it must update both the processor page tables and, if not shared, the I/O page tables and issue appropriate page-invalidate commands to both the processor and the IOMMU. Unlike the processor, the IOMMU requires page-invalidate commands after any change to the I/O page tables. (AMD64 processors do not require page-invalidate operations after changes to leaf page table entries that add permission and make no change to translation.) Sharing of page tables is discussed in [Section 2.2.1 \[Updating Shared Tables\]](#) and [Section 2.2.4 \[Sharing AMD64 Processor and IOMMU Page Tables—GPA-to-SPA\]](#).

Since the IOMMU offers no facilities for restarting device accesses to unmapped or protected addresses, all pages that the device might access must be mapped with appropriate permissions. In this respect the IOMMU is similar to the GART.

1.2.2 Replacing the Device Exclusion Vector Mechanism

The Device Exclusion Vector (DEV) is a basic security mechanism that was introduced with the AMD64 Secure Virtual Machine (SVM) Architecture. Like the IOMMU, the DEV allows I/O devices to be classified into different domains. Associated with each domain is a bit vector, indexed by physical page address, indicating whether I/O devices in that domain are allowed to access the corresponding physical page.

The IOMMU provides protection and translation. If only protection is needed, software can create identity-mapped I/O page tables that specify the desired protection.

1.2.3 32-bit to 64-bit Legacy I/O Device Mapping

With the advent of large physical memories, legacy 32-bit devices that rely on DMA can no longer arbitrarily access system memory. This complicates operating systems, which must introduce a distinction between low memory and high memory and perform appropriate bookkeeping to ensure that legacy I/O devices are only commanded to perform transfers using low memory. The cost is not just complexity; to perform a transfer from a legacy I/O device to high memory, for example, the operating system typically allocates a bounce buffer in low memory, performs the transfer in low memory, and then copies the result to the real destination in high memory. For high-bandwidth I/O devices like disk controllers and network interfaces, the performance cost of bounce buffer allocation and copying can be large.

In some operating systems, the GART has been used to work around this problem. When the OS

wishes to perform a transfer between a legacy I/O device and high memory, it allocates a portion of the GART aperture and maps those pages to high memory. It then commands the I/O device to execute the transfer using the address within the GART aperture, which must be located in low memory. Although this approach avoids the cost of bounce buffer copies, it is less than desirable, since the relatively small GART aperture must be shared by all legacy I/O devices and any graphics processors in the system. The device drivers have additional locking and synchronization overhead associated with page allocation and de-allocation in the GART aperture and system performance may be degraded due to serialization waiting for the GART aperture to become available.

The IOMMU provides a better solution. First, IOMMU translation applies to the full range of addresses an I/O device can generate, rather than requiring high-memory transfers to be mapped only within the narrow range of GART addresses. Moreover, the IOMMU's ability to assign each I/O device to a different domain means that heavily used I/O devices can be given their own sets of I/O page tables and do not have to contend with other I/O devices for allocation and de-allocation of I/O pages.

1.2.4 User Mode Device Accesses

The IOMMU plays a crucial role in allowing arbitrary I/O devices to be safely controlled by user-level processes, since I/O devices whose memory accesses are translated by the IOMMU can only access pages that are explicitly mapped by the associated I/O page tables. The I/O devices' access can therefore be limited to those pages to which the user processes legitimately have access.

Setting up the IOMMU for user-level I/O to an I/O device may be set up similarly to GART emulation with two differences; first, the mappable address range is the entire range of I/O device-generatable addresses, and secondly, the operating system is not necessarily required to make exactly equivalent mappings in the processor page tables (although most likely it will).

Even with the help of the IOMMU, enabling user level I/O device access involves many design considerations. Protecting and remapping DMA is one part of the problem; the other part is interrupt management, for which the IOMMU provides help.

As was the case with GART emulation, system software must assess the need to lock in memory all pages that might ever be accessed by an I/O Device controlled by a user-level process. It may be possible to avoid needing to lock in memory if an I/O Device can use peripheral page request (PPR) mechanism, optionally implemented by IOMMU, to generate page fault as and when it touches a page.

1.2.5 Virtual Machine Guest Access to Devices

The IOMMU can be used to allow unmodified virtual machine guest operating systems to directly access I/O devices. This is really just a special case of allowing user-level access to I/O devices, but there are a few considerations that warrant separate mention.

First of all, a non-VM-aware guest has no current way of informing its Hypervisor (HV) which pages an I/O device might access, so the HV must lock the entire guest in memory. The HV's I/O page tables for the guest should then simply map guest physical addresses to system physical addresses. If the HV is running the guest under nested paging and is using nested page tables built to be compatible with the IOMMU, then the IOMMU can directly share the host CPU page tables for the guest.

Often a single virtual machine (VM) guest has direct access to multiple I/O devices. By design, all I/O devices in the guest that need to see exactly the same I/O page translations can share a DomainID (see “Data Structures” on page 58). If all the I/O devices belonging to a given VM guest are assigned to the same domain then the IOMMU can share translation cache entries among any of the guest’s I/O devices.

Finally, guest I/O throughput is often significantly enhanced when guest memory is allocated using large pages on the host system. Then the I/O page tables can similarly use large pages and the IOMMU is more likely to avoid thrashing in its translation cache.

1.2.6 Virtualizing the IOMMU

The IOMMU has been designed so that it can be emulated in software by a HV that wishes to present its VM guests the illusion that they have an IOMMU.

HVs that run non-VM-aware guests already intercept and emulate attempts by their guests to access PCI configuration space. Therefore, emulation of the IOMMU configuration registers is straightforward; the emulation can be hooked directly to the existing facilities of the HV for intercepting PCI configuration space accesses.

The HV must also arrange to intercept and emulate guest accesses to the IOMMU's MMIO-mapped command registers. Since the overhead of each HV intercept is high, guest operating systems accessing the IOMMU have better performance when they enqueue batches of commands in the IOMMU's Command Buffer located in system memory prior to initiating IOMMU command processing via an MMIO register access.

Since an untrusted guest OS cannot be allowed to write in the real Device Table, the HV must maintain shadow entries in the real table on behalf of the guest. The IOMMU architecture requires software to issue invalidate-entry commands to the IOMMU after updating Device Table entries. The HV can intercept these invalidate commands, look up the corresponding entries in the guest's simulated Device Table, and make shadow entries in the real Device Table on behalf of the guest. Note that the DeviceIDs as seen by the guest need not be the same as the real DeviceIDs and the DomainIDs used by the guest are almost certainly different from the DomainIDs used by the HV in the real Device Table.

In addition, for each guest VM I/O page table, the HV must construct a shadow I/O page table. This shadow I/O page table is the page table that is given to the real IOMMU. Unfortunately, since an incomplete I/O device access cannot be restarted, the HV must construct each guest domain's complete shadow I/O page tables eagerly as soon as the guest enables paging for that domain. The HV must write-protect guest I/O page tables from the guest in order to intercept all guest updates and propagate the updates to the shadow I/O page tables.

The Hypervisor (HV) can also implement a subset of the IOMMU optional features by reporting that subset via the [IOMMU Extended Feature Register \[MMIO Offset 0030h\]](#). The subset of additional features can be implemented using the same techniques described above.

1.2.7 Virtualized User Mode Device Accesses

An IOMMU with two-level translation enforces system protection policies while allowing arbitrary

I/O devices to be properly controlled by user-level processes in a virtualized system. As noted in [Section 1.2.4 \[User Mode Device Accesses\]](#), I/O devices whose memory accesses are translated by the IOMMU can only access pages that are explicitly mapped by the associated I/O page tables as granted by the HV and operating system. The I/O devices' access can therefore be limited to only those pages to which the user-level processes legitimately have access when the device supplies PASID information. This means I/O operations can be initiated without hypervisor or operating system intervention.

In addition to address translation, enabling user level I/O device access involves other design considerations such as remapping interrupts.

System software must assess the need to lock in memory all pages that might ever be accessed by an I/O device controlled by a user-level process. Peripherals that use ATS can use the peripheral page request mechanism when implemented by an IOMMU to avoid needing to lock in all pages. As was the case with GART emulation, system software must assess the need to lock in memory all pages that might ever be accessed by an I/O device controlled by a user-level process. If a peripheral has support for the PCI Express ATS protocol and implements an IOTLB and in addition implements support for the optional Peripheral Page Request protocol (PRI/PPR), then system software (Operating System or Hypervisor) is able to support pageable memory access for user level controlled I/O devices.

1.3 IOMMU Optional Features

All implementations of the IOMMU provide a base set of capabilities. This base functionality is also known as IOMMU Revision 1.

Subsequent revisions of this specification added new software-observable features. All these features are technically optional, although most IOMMU implementations included all of the features that were defined at the time of their design.

Architecturally, however, software must determine support for *each* feature and must enable each feature before using it.

Optional features include:

- Guest virtual to guest physical address translation capability
- AMD64 long mode page table compatibility
- Support for PCI ATS
- Support for PCI-SIG PRI and PASID TLP prefix ECN
- Support for a guest virtual APIC (e.g., AVIC)
- Enhanced performance and error logging features
- Guest page table User/Supervisor access privilege checking
- Guest page table Global Supervisor-level access protection
- Guest page table non-executable page protection
- Segmentation of the Device Table
- PPR and Event Log dual buffers with optional autoswap
- PPR Auto Response with Always-on feature

- PPR Log early overflow warning
- Device-specific feature reporting registers
- MMIO access to MSI setup and mapping configuration space fields
- Memory Access Routing and Control (MARC)
- Automatic Block StopMark Message Handling
- Guest I/O Protection
- x2APIC
- Hardware Accelerated Virtualized IOMMU (vIOMMU)
- Secure ATS
- Secure Nested Paging

All implementations of the IOMMU support basic capabilities such as Device Virtual to System Physical Address translation, interrupt remapping, and access permissions checking. To determine if a particular implementation of the IOMMU supports any of the architecturally-defined optional features, software must first check that the EFRSup bit of the [IOMMU Capability Header \[Capability Offset 00h\]](#) (EFR) is set. If the EFRSup bit is set, the [IOMMU Extended Feature Register \[MMIO Offset 0030h\]](#) is supported. By reading the EFR software can determine which of the optional features are supported by the particular IOMMU present in that system. In most cases, support for a feature is indicated by a non-zero value in the respective field of the EFR.

The EFRSup bit and many of the feature and capability reporting fields related to I/O virtualization are replicated in the IOMMU ACPI Tables. Information reported via this method supersedes information reported via the Extended Feature Register and the Miscellaneous Information Register. See [Chapter 5, "I/O Virtualization ACPI Table"](#).

Software Implementation Note: *Software should not rely on the feature support information conveyed by the IOMMU Extended Feature Register for any feature that is also reported in the ACPI tables since system firmware can override the functional capabilities reported by the IOMMU hardware.*

[Table 2](#) below lists all the architecturally defined features and specifies the field to test to determine support for that feature. In the table, EFR refers to the [IOMMU Extended Feature Register \[MMIO Offset 0030h\]](#), CapHdr refers to the [IOMMU Capability Header \[Capability Offset 00h\]](#), and CNTRL refers to the [IOMMU Control Register \[MMIO Offset 0018h\]](#).

Table 2: Software-Visible Features

Feature Name	Feature Description	Determining Support	Initial Spec Rev
Single layer address translation	Section 2.2.3 [I/O Page Tables for Host Translations]	Base Support	1.0
Interrupt remapping	Section 2.2.5 [Interrupt Remapping Tables]	Base Support	1.0
IOMMU EFR	IOMMU Extended Feature Register [MMIO Offset 0030h].	CapHdr[EfrSup]	1.2
Address Translation Services (ATS)	Section 2.2.7 [Guest and Nested Address Translation]	CapHdr[IotlbSup]	1.2
Guest Translation	Section 1.3.1 [Two-level Translation for Guest and Host Address Spaces],	EFR[GTSup]	2.0
PASID	Section 2.2.7.7 [PCIe® TLP PASID Prefix]	EFR[GTSup]	2.0
PPR Support	Section 1.3.5 [Peripheral Page Request Support Compatible with PCI-SIG PRI]	EFR[PPRSup]	2.0
Performance Counter Support	Section 1.3.3.1 [Performance Counters]	EFR[PCSup]	2.0
SMI filter	Section 1.3.10 [SMI Filter]	EFR[SmiFSup]	2.0
Guest virtual APIC	Section 1.3.7 [AMD64 Interrupt Virtualization (Guest Virtual APIC Interrupt Controller)]	EFR[GASup]	2.5
Hardware error registers	Section 1.3.11 [Hardware Error Registers]	EFR[HESup]	2.0
Multi-level guest CR3 Table	Section 2.2.6.3 [Guest CR3 Table]	EFR[GLXSup]	2.0
Invalidate all command	Section 2.4.8 [INVALIDATE_IOMMU_ALL]	EFR[IASup]	2.0
Prefetch command	Section 2.4.6 [PREFETCH_IOMMU_PAGES]	EFR[PreFSup]	1.24
No Execute page protection	Section 2.2.6.1 [Support for AMD64 Guest Page Table NX field]	EFR[NXSup]	2.0
Privileged access protection	Section 2.2.6.2 [AMD64 Guest Page Table Access Protection]	EFR[USSup]	2.0
Global Privileged Page Access Abort	Section 2.2.6.2 [AMD64 Guest Page Table Access Protection]	EFR[USSup] && CNTRL[PrivAbtEn] = 01b	2.6
Device Table Segmentation	Section 2.2.2.3 [Device Table Segmentation]	EFR[DevTblSegSup]	2.6
Dual Event Buffer	Section 2.5.17 [Event Log Dual Buffering]	EFR[DualEventLogSup]	2.6
Dual PPR Buffer	Section 2.6.1 [PPR Log Dual Buffering]	EFR[DualPprLogSup]	2.6
Device-Specific Extensions Reporting	Section 3.4.7 [Device-Specific Feature Registers]	—	2.6
MMIO access to MSI Capability Registers	Section 3.4.8 [MMIO Access to MSI Capability Block Registers]	EFR[MsiCapMmioSup]	2.6
PPR log overflow protection—Auto Response	Section 2.6.4 [PPR Log Overflow Protection]	EFR[PprAutoRspSup]	2.6

Table 2: Software-Visible Features (Continued)

Feature Name	Feature Description	Determining Support	Initial Spec Rev
PPR log overflow protection—Always-On Auto Response	Section 2.6.4 [PPR Log Overflow Protection]	EFR[PPRAutoRspSup] && CNTRL[AutoRespAON]	2.6
PPR log overflow protection—Overflow Early Warning	Section 2.6.4 [PPR Log Overflow Protection]	EFR [PprOvrflwEarlySup]	2.6
PPR log overflow protection—Block StopMark	Section 2.6.4 [PPR Log Overflow Protection]	EFR[BlkStopMrkSup]	2.6
Memory Access Routing and Control	Section 2.9 [Memory Address Routing and Control (MARC)]	EFR[MarcSup]	2.6
IOMMU Performance Optimization	Section 3.4.9 [Performance Optimization Control Register]	EFR[PerfOptSup]	2.6
Host Access and Dirty	Section 1.3.8 [Enhanced Support for Access and Dirty Bits]	EFR[HADSup] and EFR[HDSup]	3.00
Guest I/O Protection	Section 1.3.9 [Guest I/O Protection]	EFR[GIoSup]	3.00
x2APIC Support	Section 2.2.5.3 [IOMMU x2APIC Support]	EFR[XTSup]	3.05
Secure ATS Support	Section 2.11 [Secure ATS Support]	EFR[SATSSup]	3.06
Hardware Acceleration for Virtualized IOMMU (vIOMMU)	Section 1.3.12 [Hardware Accelerated Virtualized IOMMU (vIOMMU)]	EFR[vIOMMUSup]	3.06
Secure Nested Paging (SEV-SNP)	Section 1.3.13 [Secure Nested Paging (SEV-SNP)]	EFR[SNPSup]	3.06
Disable IRTE Caching	IOMMU Control Register MMIO Offset 0018h[IRTCacheDis]	MMIO Offset 0018h [IRTCacheDis]	3.06
GPA based GCR3 Table Root Pointer	Section 2.2.6.3 [Guest CR3 Table]	MMIO Offset 01A0h [GCR3TRPModeSup]	3.07
Support for AMD64 Level 5 (PML5E) Page Table	Section 2.2.6.4 [Support for AMD64 Level 5 (PML5E) Page Table]	Capability Offset 10h [GVAsize]	3.07
Suppress Guest APIC Physical Processor Interrupt	Section 2.2.5.4 [Guest APIC Physical Processor Interrupt]	MMIO Offset 01A0h [GAPPIDisSup]	3.07
Guest APIC Physical Processor Interrupt	Section 2.2.5.4 [Guest APIC Physical Processor Interrupt]	MMIO Offset 0030h [GAPPISup]	3.07

1.3.1 Two-level Translation for Guest and Host Address Spaces

The IOMMU adds an optional layer of guest address translation similar to the processor two-level nested paging capability. The layered address translation may be viewed as nested address spaces as illustrated in Figure 2. Each address space has a set of address translation tables. The IOMMU can provide guest-physical-to-system-physical address translation managed by the hypervisor (sometimes called “L2 translation”). The Device Table entry is extended to include optional address translation information for guest-virtual-to-guest-physical address translation managed by the guest operating system (sometimes called “L1 translation”). This allows for advanced computing architectures in vir-

tualized systems such as compute-offload, user-level I/O, and accelerated I/O devices. The IOMMU indicates that two-level translation is supported via [MMIO Offset 0030h](#)[GTSup]. When supported, two-level translation is activated by programming the appropriate Device Table entries.

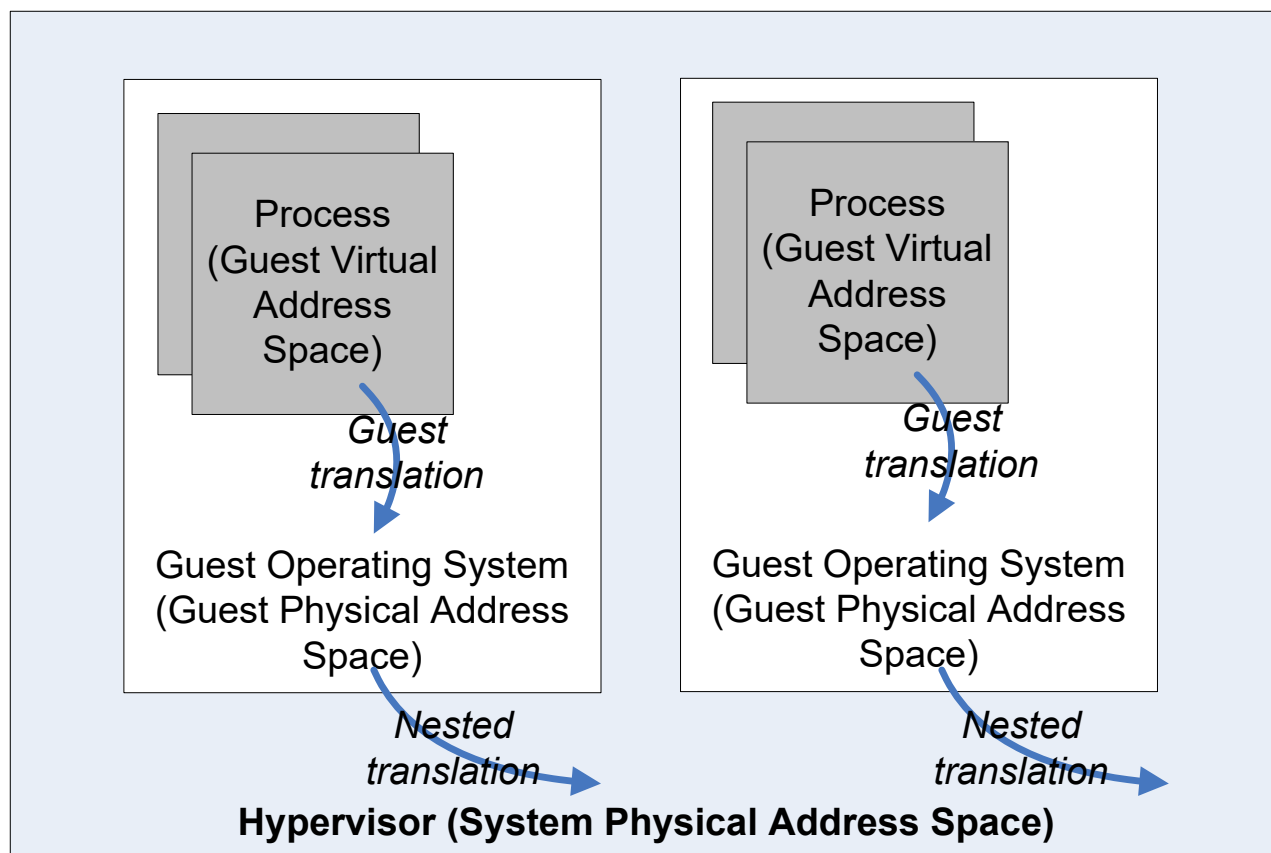

Figure 2: Nested Address Spaces

Guest address translation tables can support up to 1048576 (2^{20}) concurrent processes as an architectural limit. However, a given implementation may support fewer. The value of the field [MMIO Offset 0030h](#)[PASmax] can be used to calculate the maximum PASID supported. The guest address translation tables contain guest physical addresses and the tables are indexed using guest virtual addresses. As a result, the tables are managed by the guest operating system within a virtual machine. The HV manages the nested translation tables and the IOMMU hardware provides mechanisms to keep the tables synchronized and to handle exception conditions. The IOMMU automatically walks address translation tables based on control bits set by system software.

The IOMMU can be used in three operational modes—legacy one-level translation, guest and nested translation, and one-level guest translation with processor compatible page tables

- For legacy operation, software clears the GV bit in Device Table Entry (DTE). See “[Device Table Entry Format](#)” on page 61.
- For guest and nested two-level translation, software checks [MMIO Offset 0030h](#)[GTSup]=1. Software is then able to program Device Table entries for two-level translations.
- For one-level translation with processor compatible page tables, software programs the IOMMU

for guest and nested translation but programs DTE[Mode] = 000b for the nested translation.

1.3.2 Enhanced Processor Page Table Compatibility

In its base functionality, the IOMMU can share nested (host) page tables with an AMD64 processor when the Reserved fields are programmed to zeros. In contrast to the processor, the IOMMU does not re-walk page tables when an access violation is detected using cached information. When the IOMMU detects an access violation in a nested transaction, either from a TLB hit or from a page-table walk (TLB miss), it blocks the access or returns an ATS response with the calculated access privileges. When the IOMMU determines the proper access privileges are present, it allows the requested access or returns an ATS response with the calculated access privileges.

Processor Page Table Compatibility Feature. The compatibility of the IOMMU with AMD64 long mode page tables is enhanced when operating in AMD64 mode. The IOMMU can directly share AMD64 long mode page tables with the processor for guest address translations. The guest page translation tables are strictly compatible with the AMD64 long mode format and semantics, including IOMMU updates to the Accessed and Dirty bits (see [Section 2.2.6 \[I/O Page Tables for Guest Translations\]](#) and [Section 2.2.7.4 \[Updating Accessed and Dirty Bits in the Guest Address Tables\]](#)). When guest translation is used, the IOMMU follows the AMD64 long mode address translation requirements for guest virtual addresses and thus software is not required to issue an invalidation command when it promotes guest access privileges; only when software demotes guest access privileges or removes the guest page (“present to not-present”) must software issue an invalidation. Therefore an ATS request or DMA reference that results in insufficient guest privileges calculated from a TLB entry may be based on stale information. To determine current permissions, the IOMMU rewalks the guest page tables to recompute access permission using information read from memory. The nested page tables may be read as a consequence of the guest table rewalk. The IOMMU determines the results of the access based on the newly read page table information. The rewalk may require a full walk of both guest and nested translations. Details are in [Section 2.2.7 \[Guest and Nested Address Translation\]](#). The AMD64 long mode page tables contain information about memory types in the Page Attribute Table (PAT); the IOMMU can provide memory type information to a peripheral but does not interpret or validate the information.

1.3.3 Performance Features

The IOMMU provides three performance-oriented features: performance counters, the PREFETCH command, and the FLUSH_ALL command.

1.3.3.1 Performance Counters

To provide system software with consistent performance monitoring and evaluation mechanisms, an optional set of performance counters are defined. Support is indicated by the PCSup bit of the [IOMMU Extended Feature Register \[MMIO Offset 0030h\]](#). An implementation may provide counters in addition to the architecturally defined counters. The counters run independently from processor activity. The counters are organized into n counter banks, each of which fits in a 4-Kbyte page. The HV may privately control all counter banks or assign one or more counter banks to a guest operating system. The number of counters and counter banks are reported to system software (see [Section 3.4 \[IOMMU MMIO Registers\]](#) and [Section 5.2.2.1 \[I/O Virtualization Hardware Definition \(IVHD\)\]](#))

Block]). Each counter bank has controls that filter for devices and event sources of interest. Each event counter is programmed to count events or the duration of the events and each counter register has an optional signal for thresholding purposes (see [Section 2.5.11 \[EVENT_COUNTER_ZERO Event\]](#)).

When performance counters are supported ([MMIO Offset 0030h\[PCSup\] = 1](#)), software must allocate a 512-Kbyte region of contiguous system memory for the IOMMU MMIO registers. The region must be 4-Kbyte aligned. If performance counters are not supported by the IOMMU ([MMIO Offset 0030h\[PCSup\] = 0](#)), the allocation requirement drops to 16 Kbytes.

1.3.3.2 Loading the IOMMU TLB

The optional `PREFETCH_IOMMU_PAGES` command gives system software the ability to load the IOMMU TLB with relevant translation information (see [Section 2.4.6 \[PREFETCH_IOMMU_PAGES\]](#)), especially error processing information ([Section 2.4.6.1 \[Event Processing for PREFETCH_IOMMU_PAGES\]](#)).

Support for the prefetch feature is indicated by [MMIO Offset 0030h\[PreFSup\]](#). If `PreFSup=0`, a `PREFETCH_IOMMU_PAGES` command causes the IOMMU to create an error event ([Section 2.5.6 \[ILLEGAL_COMMAND_ERROR Event\]](#)). Because a TLB is a caching structure, the prefetch command must be considered advisory. Even if the IOMMU were to fetch the address translation information for every prefetch command, the TLB entry may be overwritten by other translation information before it is ever used and an attempt to use the translation information would cause a page table walk after all.

The `PREFETCH_IOMMU_PAGES` command is a hint to the IOMMU that the associated translation records will be needed relatively soon and that the IOMMU should execute a page table walk to load the translation information. Based on internal status and workloads, the IOMMU may fetch the translation information into a TLB. If an entry is already in the TLB, the IOMMU may adjust LRU or other control tags to lengthen cache residency.

1.3.3.3 Flushing the IOMMU TLB

The base function of the IOMMU provides the `INVALIDATE_DEVTAB_ENTRY` command (per DeviceID), the `INVALIDATE_IOMMU_PAGES` command (per DomainID), and the `INVALIDATE_INTERRUPT_TABLE` command (per DeviceID) which software can use to invalidate I/O TLB entries.

The optional `INVALIDATE_IOMMU_ALL` command may simplify trusted boot, error recovery, and resumption from low-power states (see [Section 2.4.8 \[INVALIDATE_IOMMU_ALL\]](#)). At the completion of an `INVALIDATE_IOMMU_ALL` command, all IOMMU TLBs are invalidated, including cached portions of the Device Table, guest CR3 table, page directory entries, page table entries, and interrupt remapping entries (including the Guest APIC Table Root Pointer). [Section 2.4.11 \[IOMMU Ordering Rules\]](#) describes how outstanding operations must be handled.

The operational status of the IOMMU is not affected by `INVALIDATE_IOMMU_ALL`. Translations, command and event processing, address translation requests, and peripheral page request processing continue normally. The contents of the MMIO registers are not affected except to advance the Command Buffer Head Pointer Register [[MMIO Offset 2000h](#)] beyond the `INVALIDATE_IOMMU_ALL`

command. The IOMMU may start reloading internal caches with information at any time after the `INVALIDATE_IOMMU_ALL` command completes. The `INVALIDATE_IOMMU_ALL` command guarantees ordering as described in [Section 2.4.11 \[IOMMU Ordering Rules\]](#).

Note that the `INVALIDATE_IOMMU_ALL` command does not invalidate remote IOTLBs. In the case of ATS, invalidation can be achieved by disabling and re-enabling ATS on each PCI device/function.

Support for the `INVALIDATE_IOMMU_ALL` command is indicated by the `IASup` bit of the [IOMMU Extended Feature Register \[MMIO Offset 0030h\]](#).

1.3.4 Address Translation Services for Guest Virtual Addresses

Base Function. Address translation services can be used by a peripheral to translate a GPA to an SPA. To translate a GPA to an SPA, a PCIe[®]-connected peripheral issues an ATS request lacking a PASID TLP prefix recognized by the IOMMU (see [Section 2.2.7.7 \[PCIe[®] TLP PASID Prefix\]](#)). The IOMMU evaluates access privileges using cached information and walks the page tables when required. The resulting access privileges are returned in the ATS response.

Optional Enhancements. Address translation services can be used by a peripheral to translate a GVA or GPA to an SPA. To translate a GVA to an SPA, a peripheral issues an ATS protocol request. The request contains a valid PASID, the access attribute flags and a (canonical) virtual address (see [Section 1.3.6 \[Selecting Translation Tables in a Memory Transaction\]](#) and [Section 2.2.7.7 \[PCIe[®] TLP PASID Prefix\]](#)). An integrated peripheral may use means other than the ATS protocol to present flags and the virtual address, such as wire signals. The IOMMU evaluates access privileges using cached information for efficiency and walks the page tables when required. To match AMD64 semantics, the IOMMU must re-walk the guest page tables if previously cached information indicate insufficient privileges for the access (see [Section 2.2.7.1 \[Combining Guest and Host Address Translation\]](#) and [Table 32 on page 114](#)). The resulting access privileges are returned in the ATS response. To carry the additional information for a guest address, the IOMMU uses a PCIe TLP prefix containing a valid PASID.

The IOMMU must update the Accessed and Dirty bits in the GVA page table while servicing an ATS request as if the peripheral had actually accessed memory (see [Section 2.2.7.4 \[Updating Accessed and Dirty Bits in the Guest Address Tables\]](#)). For the purpose of evaluating GVA Accessed and Dirty bits, the IOMMU must use the access level indicated in the ATS packet. An ATS request for read-only access determines the Accessed bit setting and an ATS request for read-write access determines the Dirty bit setting (see [Table 32 on page 114](#)). When processing a GPA, the IOMMU treats the page tables as read-only.

Software Note: *Software must issue an invalidation command when it changes A or D bits in a page table entry to 0 from 1. This requirement allows the IOMMU to cache the A & D bits in a TLB for higher performance.*

Software issues an `INVALIDATE_IOTLB_PAGES` command to cause the IOMMU to generate an invalidation request to the peripheral (see [Section 2.4.4 \[INVALIDATE_IOTLB_PAGES\]](#)). An invalidation request sent to the device lacks a valid PASID prefix when the contents are a GPA. An invalidation request sent downstream to the device has a valid PASID prefix when the contents are a

GVA and the PASID is in the PASID TLP prefix field of the command.

The conditions under which a peripheral with an IOTLB must invalidate a cached translation entry that caused an insufficient-privilege check and obtain a fresh translation using ATS are described in [Section 2.1.4.8 \[Discarding Device IOTLB Information to Rewalk Page Tables\]](#).

1.3.5 Peripheral Page Request Support Compatible with PCI-SIG PRI

IOMMU optionally supports the PCI-SIG PRI specification as a complement to PCI-SIG Address Translation Service (ATS) specification (see [Section 2.1.1 \[Normal Operation\]](#)). The IOMMU support for PRI is called peripheral page request (PPR) logging (see [Section 2.6 \[Peripheral Page Request \(PPR\) Logging\]](#)).

The operating system is usually required to pin memory pages used for I/O; the pinned pages are often allocated from a separate memory pool of limited capacity. ATS and PRI can be used together to enable the peripheral to use unpinned pages for I/O. When processing ATS requests, the IOMMU does not signal events when insufficient access privileges or not-present pages are detected; instead it returns the permissions calculated from the page tables. The peripheral examines the response to determine an appropriate action (e.g., use PRI to request system software to service a page table entry). Use of PRI/PPR allows a peripheral to request the operating system to change the access privileges of the page or request the page to be made present in the memory (it was not present).. Use of ATS with PRI/PPR can allow a system to operate efficiently under low available memory.

1.3.6 Selecting Translation Tables in a Memory Transaction

In the base capabilities of the IOMMU, a PCIe packet contains a GPA and the originating BDF is used to select GPA-to-SPA translation tables. A PCI-SIG TLP prefix is not interpreted by the IOMMU.

An optional feature adds support for translating guest virtual addresses to system physical addresses using the page tables programmed by the guest operating system. The PCI-SIG defines a method to add information to a transaction called the TLP prefix. When a PCIe transaction has a PASID TLP prefix, the packet contains a canonical GVA and the TLP prefix selects the guest tables for GVA-to-GPA translation; when a PCIe transaction has no TLP prefix, the packet contains a GPA. The originating BDF is used to select GPA-to-SPA translation tables. Details are in [Section 2.2.7.7 \[PCIe® TLP PASID Prefix\]](#).

1.3.7 AMD64 Interrupt Virtualization (Guest Virtual APIC Interrupt Controller)

The IOMMU optionally supports interrupt virtualization . Device interrupts can be delivered directly to running guest virtual machines without hypervisor intervention when interrupts are virtualized (see [MMIO Offset 0030h\[GASup\]](#) and [MMIO Offset 0018h\[GAEn\]](#)). This can reduce the delivery latency and overhead of guest VM interrupts. This feature requires compatible APIC virtualization support in the processor. The processor and the IOMMU coordinate to maintain interrupt state in the Guest Virtual APIC Table when delivering interrupts. Interrupt remapping and interrupt virtualization may be enabled independently. See details in [Section 2.2.8 \[Guest Virtual APIC Table for Interrupt Virtualization\]](#).

1.3.8 Enhanced Support for Access and Dirty Bits

Access bit (A) in page descriptor indicates whether the physical page to which the descriptor points to has been accessed. Dirty bit (D) in a page descriptor indicates whether the page-translation table or the physical page to which this descriptor points has been written to by a peripheral.

The A bit in the guest page table is set to 1 by the IOMMU the first time the descriptor or the physical page is either read from or written to. The D bit in the guest page table is set to 1 by the IOMMU the first time a device writes to the physical page or the descriptor is accessed for an intended write to the corresponding physical page.

Optionally IOMMU hardware can set A and D bit in the host page table (see [IOMMU Extended Feature Register \[MMIO Offset 0030h\]](#) HASup and HDSup). When enabled the IOMMU will set A and D bits to host page table in process similar to that described in [Section 2.2.7.4](#).

Note that IOMMU hardware never clears A or D bits.

System software can use the A bits to help decide to choose candidate pages for page out. D bits can be used to avoid redundant write-backs to storage.

1.3.9 Guest I/O Protection

Optionally the IOMMU enables Guest I/O protection even for devices that do not support PASID [Refer to [Section 2.2.9](#)]. When enabled, a default PASID equal to 0 is assigned to DMA requests without PASID associated with the enabled DTE. The DMA requests then go through guest and nested translations as usual. Operating systems can use this feature to enable I/O protection buffers using guest page table for devices that may not support PASID.

1.3.10 SMI Filter

The IOMMU optionally supports the interception of System Management Interrupts (SMI) that are unexpected by system firmware or software. SMIs that are vital to system operation and integrity are delivered as usual but SMIs from suspect sources can be blocked or deferred for later processing or analysis. See [Section 2.1.5 \[System Management Interrupt \(SMI\) Controls\]](#) for details of SMI filter operation.

1.3.11 Hardware Error Registers

All error events are reported in the IOMMU event log. Optionally, error reporting is enhanced by logging critical events in the hardware error registers. See IOMMU Hardware Event Upper Register [[MMIO Offset 0040h](#)], IOMMU Hardware Event Lower Register [[MMIO Offset 0048h](#)], and IOMMU Hardware Event Status Register [[MMIO Offset 0050h](#)].

1.3.12 Hardware Accelerated Virtualized IOMMU (vIOMMU)

The IOMMU may optionally support the vIOMMU feature which provides partial hardware acceleration when implementing Guest IOMMUs. Guest IOMMUs are IOMMUs exposed to VMs. vIOMMU provides acceleration when a VM accesses its Command Buffer, PPR Log, and Event Log. This eliminates the CPU overhead needed for the supporting HV intercepts and reduces the latency of these operations.

The HV continues to emulate the IOMMU configuration space registers and a subset of the IOMMU MMIO registers which are primarily used during initialization. Additionally, the HV must initialize the vIOMMU feature, map MMIO resources between the VMs and the IOMMU, manage additional supporting data structures in memory, and allocate backing storage memory for the IOMMU.

The previously defined Two-Level Translation feature enabled the IOMMU to walk Guest page table data structures created by a VM.

Under vIOMMU, the IOMMU exposes MMIO resources that can be used to implement a portion of each VM's guest IOMMU MMIO register space. When a VM attempts to access guest IOMMU MMIO registers with offsets between 8KB and 12KB such as the Command Buffer, Event Log and PPR Log head and tail pointer registers, this is serviced directly by the IOMMU. When the IOMMU accesses a VM Command Buffer, PPR Log or a COMPLETION_WAIT store location in memory, it directly accesses VM guest physical memory. The IOMMU translates fields such as Device ID and Domain ID between VM encodings and the corresponding HV encodings as necessary. Finally, the IOMMU may directly issue interrupts to the VM IOMMU driver such as for COMPLETION_WAIT commands or due to writing the PPR Log.

The vIOMMU architecture is designed to support up to 64K simultaneous VMs. It is possible for the HV to enable vIOMMU in some VMs while providing a fully emulated IOMMU to other VMs.

See [Section 2.10 \[vIOMMU\]](#) for more details.

1.3.13 Secure Nested Paging (SEV-SNP)

The SEV-SNP feature provides additional memory security checks to better isolate Guest memory. It leverages a separate Reverse Map Table (RMP) data structure that provides information associated with each SPA page.

See [“IOMMU Secure Nested Paging \(SEV-SNP\) Support” on page 192](#) for more details.

Refer to APM2 and SNP-WP for more details on SEV-SNP.

2 Architecture

This chapter describes the IOMMU's architecture mainly from a system software point of view. The discussion starts with the normal steady state behavior of the IOMMU once it has been set up, focusing on how the IOMMU handles various device transactions. The following section describes the in-memory data structures used to control the IOMMU, together with the procedures software must follow to correctly update these (shared) data structures. Finally, the chapter concludes with a description of the PCI resources that must be initialized at system startup time to configure the IOMMU.

2.1 Behavior

When the IOMMU is disabled it simply passes all bus traffic through without alteration.

When the IOMMU is enabled, it intercepts requests arriving from downstream devices (which may be attached to the system via the data fabric, PCIe link, or other means), performs permission checks and address translation on the requests, and sends translated versions upstream to system memory. Other requests are passed through unaltered (details in [Section 2.1.1 \[Normal Operation\]](#)). PCI devices serviced by a single IOMMU must be on the same PCI Segment Group (see PCI Firmware specification for further details of PCI Segment Groups).

The IOMMU reads three tables in system memory to perform its permission checks, interrupt remapping, and address translations. To avoid deadlock, memory accesses for device tables, page tables, and interrupt remapping tables by the IOMMU use an isochronous virtual channel and may only reference addresses in system memory. Other memory reads originated by the IOMMU to command buffers, event log entries, and optional request queue entries use the normal virtual channel. System performance could be substantially reduced if the IOMMU performed the full table lookup process for every device request it handled. Therefore, implementations of the IOMMU are expected to maintain internal caches for the contents of the IOMMU's in-memory tables, and correct operation of the IOMMU requires system software to send appropriate invalidation commands to the IOMMU when it updates table entries that may have been cached by the IOMMU.

The IOMMU writes to the event log in system memory using the normal virtual channel. The IOMMU can optionally write to the peripheral page request log in system memory and these writes use the normal virtual channel. The IOMMU can optionally write to the guest virtual APIC log in system memory and these writes use the normal virtual channel.

The IOMMU signals interrupts using standard PCI MSI or MSI-X interrupts.

2.1.1 Normal Operation

The typical flow of requests through the IOMMU is as follows:

- Read, write and interrupt transactions generated by the IOMMU are not translated by the IOMMU.
- Transactions arriving from upstream must be passed downstream unaltered.
- Transactions arriving from downstream that are response, fence, or flush commands must be passed upstream unaltered.

- Transactions arriving from downstream that reference addresses within the IOMMU exclusion range must be passed upstream unaltered.
- Memory read and write transactions from downstream result in table lookups in the Device Table to obtain the DomainID of the requesting I/O device and to locate I/O page tables. Further table lookups are required in I/O page tables to perform address translation and permission checking. After performing permission checks and address translation, the IOMMU forwards the resulting transactions upstream if the transaction is allowed from the I/O device.
- Address translation requests from downstream result in table lookups as for memory read and write transactions. Translated address and access permission information is returned to the requesting peripheral. Software is required to invalidate address translation mappings cached by a peripheral.
- Peripheral page requests from downstream result in an event log entry if not supported, or result in a peripheral page request log entry written to system memory. (Optional PPR Auto response modifies this behavior.)
- Interrupt addresses are never translated to system memory addresses, but Physical address ranges reserved for Message Signaled Interrupts (MSI) may be optionally treated as memory addresses for translation (e.g., ACPI address ranges, PCI configuration space mapping).
- Upstream interrupts result in table lookups in the Device Table and then in the interrupt remapping tables to remap the interrupt. After performing checks and interrupt remapping, the IOMMU forwards the resulting interrupts upstream if the interrupt is allowed from the I/O device. SMI requests optionally go through the SMI filter and do not use the interrupt remapping tables.
- Port I/O space transactions from downstream devices result in a Device Table lookup to determine if the I/O device is allowed to access port I/O space.
- The IOMMU maintains an event log in system memory containing the details of transactions that do not complete normally.
- The IOMMU maintains an optional guest virtual APIC log containing details of interrupt requests that arrive when the guest is not running.
- The IOMMU does not further translate pretranslated memory read and write requests from devices if the I/O device is marked as being able to generate pretranslated addresses.
- The IOMMU processes commands from the command queue.

The optional MARC feature allows accesses from integrated I/O devices such as GPUs to bypass the IOMMU when accessing defined regions of system memory.

In addition to passing on transactions from downstream devices, the IOMMU inserts transactions of its own to perform reads to and writes from system memory and to signal interrupts.

The IOMMU is allowed to cache page table and Device Table contents to speed up translations. An invalidation protocol is defined so that software can keep the cache contents consistent with memory when it updates the tables. When software initiates a suspend operation that does not preserve the state of the processor or chipset, the state of the IOMMU stored in registers is lost and must be restored as part of the resume sequence.

When system software processes a PCI hot-plug notification, the ACPI tables should be inspected to

determine the IOMMU that will service the peripheral and then program the IOMMU appropriately.

2.1.2 IOMMU Logical Topology

Once configured, the IOMMU logically resides between the I/O devices and the upstream interface. As a result of this logical topology the transactions seen by the IOMMU are defined in terms of data fabric transactions. Accesses to the system-defined address range FD_0000_0000h - FF_FFFF_FFFFh, inclusive, have special meanings. The meaning is encoded into various portions of the address as shown in Table 3 and Table 19; complete details are in the *HyperTransport™ I/O Link Specification*. Upstream transactions to these address ranges are controlled by Device Table control bits, page tables or the interrupt remapping tables. The special address controls do not apply to pre-translated addresses.

Special address controls in Table 3 are interpreted against untranslated guest physical addresses (GPA) that lack a PASID TLP prefix.

Table 3: Special Address Controls (GPA)

Base Address	Top Address	Use	Access controlled by
FD_0000_0000h	FD_F7FF_FFFFh	Reserved interrupt address space	See Section 2.5.9 [INVALID_DEVICE_REQUEST Event]
FD_F800_0000h	FD_F8FF_FFFFh	Interrupt/EOI	IntCtl, Interrupt Remapping Tables
FD_F900_0000h	FD_F90F_FFFFh	Legacy PIC IACK	Page Tables
FD_F910_0000h	FD_F91F_FFFFh	System Management	SysMgt, Page Tables
FD_F920_0000h	FD_FAFF_FFFFh	Reserved	Page Tables
FD_FB00_0000h	FD_FBF_FFFFh	Address Translation	HtAtsResv, Page Tables
FD_FC00_0000h	FD_FDFF_FFFFh	I/O Space	IoCtl, Page Tables
FD_FE00_0000h	FD_FFFF_FFFFh	Configuration	Page Tables
FE_0000_0000h	FE_1FFF_FFFFh	Extended Configuration/ Device Messages	Page Tables
FE_2000_0000h	FF_FFFF_FFFFh	Reserved	Page Tables

During configuration, an IOMMU may appear connected in different topologies that are implementation dependent.

2.1.3 IOMMU Event Reporting

The IOMMU must detect and may report several kinds of events that may arise due to unusual hardware or software behavior. When the IOMMU detects an event of any kind and event logging is enabled, it writes an appropriate event entry into the event log located in system memory. In addition, it may optionally signal an interrupt when the event log is written.

Events detected by the IOMMU include I/O page faults as well as hardware memory errors detected

when walking the I/O page tables. A detected event may cause a page table or interrupt remapping table walk to terminate before reaching the final memory-translation or interrupt-remap entry. When a walk is terminated early, the event information reported is based on the results calculated in the completed portion of the walk, starting with the Device Table Entry (DTE).

Software Note: *the TLB caching behavior of the IOMMU is not defined for an entry causing an event; some implementations may insert an entry in the TLB cache before verifying that it causes no exceptions. System software should invalidate the address that caused the event.*

2.1.3.1 IOMMU Event Responses

The IOMMU response to events depends on the type of event detected, the type of transaction that caused the event, and the state of the IOMMU at the time of the event.

If an IOMMU is not enabled or does not support address translation requests, the IOMMU responds to translation requests with a master abort.

If the IOMMU is enabled, it can have one of three event responses:

- For upstream transactions that are master aborted or target aborted, the PCI/Host bridge that is co-located with the IOMMU is the completer of the transaction. Transactions that are target aborted set the legacy Signaled Target Abort bit in a manner consistent with the bus specification over which the transaction was received (secondary port). These aborted transactions should not set any AER bits (if implemented and otherwise applicable).
- Exceptions detected in transactions that target the IOMMU function are not logged in the IOMMU event log. The exceptions are signaled following the rules of the bus specification applicable to the primary bus with which the IOMMU function is associated.
- Exceptions detected in the transactions originating from the IOMMU function signal the event following the rules of the bus specification applicable to the primary bus with which the IOMMU is associated. Additionally, exceptions in command buffer and table walk reads are logged in the IOMMU event log.

A transaction that attempts to use a Device Table entry beyond the end of the table is treated as in [Table 44](#). The size of the Device Table is defined by the Device Table Base Address Register, [MMIO Offset 0000h\[Size\]](#).

2.1.3.2 I/O Page Faults

The IOMMU may detect page-fault conditions when processing peripheral requests and the response of the IOMMU depends on the type of the request and IOMMU control settings.

A peripheral's memory transaction may result in an I/O page fault. These page faults can arise for a variety of reasons, such as I/O page table entries lacking sufficient permission or memory pages marked not-present. In a traditional processor virtual memory implementation, page faults activate an exception handler that has the option to correct the underlying problem and retry the faulting instruction. The IOMMU has no such option: the underlying data fabric and PCIe protocols do not provide a means for the IOMMU to signal a device that it should attempt to retry an access. Consequently, when the IOMMU detects an I/O page fault, it target aborts the faulting request. The IOMMU sets the legacy PCI Signaled Target Abort bit, if appropriate, and records I/O page fault information in its

event log when event logging is enabled

For an address translation request, the IOMMU returns the translation result and does not signal a fault (see also [Section 2.1.4.5 \[Address Translation Requests in the Special Address Range\]](#)). The peripheral can examine the translation response to determine if a particular memory transaction would cause an exception. Peripherals may request page fault service as described in [Section 2.6 \[Peripheral Page Request \(PPR\) Logging\]](#).

2.1.3.3 Memory Access Errors

The IOMMU's own memory accesses to its in-memory tables may themselves result in several kinds of errors, including:

- Accesses to nonexistent or non-DRAM addresses because the IOMMU's isochronous virtual channel is restricted to DRAM addresses only.
- Uncorrectable ECC errors.
- Use of reserved values, including invalid or unsupported type codes in Device Table entries and reserved bits in page table entries.

The IOMMU records all detected memory access errors in its event log when event logging is enabled. Optionally hardware errors may also be stored in the error registers (see [Section 2.5.16.2 \[I/O Hardware Event Reporting Registers\]](#)).

2.1.4 Special Conditions

This section defines the behavior of the IOMMU for particular operating conditions.

2.1.4.1 Zero-byte Read Operations

In some bus architectures, a zero-byte read operation is defined as a special operation with well-defined side effects. Because of these side effects, the IOMMU must permit a zero-byte read operation when a page is marked to allow either read or write access. Further, because the zero-byte read operation returns undefined data in some bus specifications, protecting the contents of a non-readable memory location requires that the IOMMU obscure the returned data for a zero-byte read operation.

Implementation Note: methods to obscure the returned data in a zero-byte read operation include returning a constant, a random value, or a predictable value not based on the data contents such as the address.

2.1.4.2 Interrupt Address Range

Accesses to the interrupt address range ([Table 3](#)) are defined to go through the interrupt remapping portion of the IOMMU and not through address translation processing. Therefore, when a transaction is being processed as an interrupt remapping operation, the transaction attribute of pretranslated or untranslated is ignored.

Software Note: The IOMMU should not be configured such that an address translation results in a special address such as the interrupt address range.

2.1.4.3 Multi-page Address Translation Requests Lacking a PDE

An address translation transaction to the IOMMU can request multiple pages. The page size (stride) is

generally determined by the PDE used with level=0 or level=7. The page stride is always a power of two. For situations where there is no relevant PDE (within the IOMMU exclusion range or when the DTE[Mode] = 0), the results returned by the IOMMU are implementation-specific.

2.1.4.4 Address Translation Requests in the IOMMU Exclusion Range

I/O devices may request address translations for addresses in the IOMMU exclusion range, defined by [IOMMU Exclusion Base Register / Completion Store Base Register \[MMIO Offset 0020h\]](#) and [IOMMU Exclusion Range Limit Register / Completion Store Limit Register \[MMIO Offset 0028h\]](#), and may cache the results. When software changes the exclusion range, it must invalidate remote IOTLBs that may contain affected translation entries. Address translation requests to the exclusion range always return permissions that allow reading and writing

An address translation request for a GPA within the exclusion range returns an implementation-defined result.

2.1.4.5 Address Translation Requests in the Special Address Range

I/O device address translation requests for a GPA within special address ranges in [Table 3](#) are controlled by the SysMgt and IoCtl settings in the Device Table entry (see [Section 2.2.2.1 \[Device Table Entry Format\]](#)) and can either return a translation or cause a target abort.

2.1.4.6 Page Translation Entries Spanning Memory and Special Address Ranges

An IOMMU address translation entry for a GPA may be constructed to cover both conventional memory addresses and special addresses (see [Table 3](#)). The DTE[IoCtl] and DTE[SysMgt] fields control IOMMU behavior. To translate a GPA address in a special address range, set the corresponding special address range control in the DTE to direct the IOMMU to translate the desired special address ranges as memory addresses.

2.1.4.7 Discarding IOMMU TLB Information to Re-walk Page Tables

An optional feature adds the capability for the IOMMU to rewalk the page tables under certain conditions. When the IOMMU detects an access violation based on cached information, it discards the information in the IOMMU TLB and reloads the translation information from memory. Interrupt remapping information is only loaded from memory on a TLB miss. See [Section 1.3.4 \[Address Translation Services for Guest Virtual Addresses\]](#) for details.

2.1.4.8 Discarding Device IOTLB Information to Rewalk Page Tables

An optional feature adds the capability for the IOMMU to rewalk the page tables under certain conditions. The peripheral can use address translation information from the IOTLB or obtained via ATS to determine access privileges for a nested (host) access. As an AMD extension, a peripheral with an IOTLB must invalidate a cached entry causing an insufficient-privilege failure when R=1 or W=1 in the IOTLB entry for a guest access. The peripheral must then request the guest translation information using ATS and retry the access. If the revised privileges are insufficient for the retry, the peripheral must take appropriate action to abandon the access or issue a PCIe® PRI request for escalated privileges.

2.1.4.9 Updating the Accessed and Dirty Bits in Guest Page Tables

An optional feature adds the capability for the IOMMU to write to the guest page table. The IOMMU

must update the guest page table Accessed and Dirty bits atomically. The IOMMU never clears the Accessed or Dirty bits; software is responsible to clear the bits. The IOMMU is allowed to cache these bits, so software must issue invalidation commands when it clears the bits in a PTE. See [Section 2.2.7.4 \[Updating Accessed and Dirty Bits in the Guest Address Tables\]](#) and [Section 2.2.7.5 \[Clearing Accessed and Dirty Bits\]](#) for details.

2.1.4.10 Address Translation Response When DTE[Mode] = 0

A peripheral can request address translations when DTE[Mode] = 000b; The returned system physical address (SPA) is equivalent to the guest physical address.

2.1.4.11 Page Splintering

When an address is mapped by guest and nested page table entries with different page sizes, the IOMMU TLB entry that is created matches the size of the smaller page (see also *AMD64 Technology, AMD64 Architecture Programmer's Manual, Volume 2: System Programming, Page Splintering*).

2.1.4.12 Atomic Operations Require Read and Write Permissions

Atomic operations both read and write a page. The IOMMU must permit atomic operations from the peripheral only when the page is marked to allow both read and write operations.

2.1.4.13 INVALIDATE_IOTLB_PAGES and Peripheral Reset

If a peripheral is reset while an INVALIDATE_IOTLB_PAGES command is being executed by the IOMMU ([Section 2.4.4 \[INVALIDATE_IOTLB_PAGES\]](#)), the peripheral may stop processing invalidations and software must process any IOTLB_INV_TIMEOUT events that result ([Section 2.5.8 \[IOTLB_INV_TIMEOUT Event\]](#)).

2.1.5 System Management Interrupt (SMI) Controls

In order to ensure AMD64 system management interrupts delivered to the processor come from valid peripheral sources (DeviceIDs), the IOMMU optionally supports an SMI filter. When [MMIO Offset 0030h\[SmiFSup\]=00b](#) or [MMIO Offset 0018h\[SmiFEn\]=0b](#), SMI interrupts from any source are delivered to the processor(s); for other values of [MMIO Offset 0030h\[SmiFSup\]](#), SMI interrupts are filtered according to the values programmed in the SMI filter registers (see [IOMMU SMI Filter Register \[MMIO Offset 00\[60-D8\]h\]](#)). The number of SMI filter registers available is in [MMIO Offset 0030h\[SmiFRC\]](#). Each SMI filter register contains a DeviceID and control bits; together, the set of SMI filter registers can be programmed to define the set of devices from which system management interrupts will be delivered.

2.1.5.1 SMI Filter Operation

While SMI filtering is enabled and supported by the IOMMU, each upstream SMI is checked to match against the SMI filter registers that are valid and enabled and an upstream SMI from a DeviceID failing to match any SMI filter register will be blocked. The fields [MMIO Offset 0018h\[SmiFEn\]](#) and [MMIO Offset 0018h\[SmiFLogEn\]](#) control the behavior of the SMI filter. When SmiFEn=1b, an upstream SMI interrupt request that matches any of the valid SMI filter registers is delivered upstream without modification. When SmiFEn=1b and SmiFLogEn=0b, an upstream SMI interrupt request that fails to match any of the valid SMI filter registers is discarded silently (i.e., not forwarded upstream). When SmiFEn=1b and SmiFLogEn=1b, an upstream SMI interrupt request that

fails to match any of the valid SMI filter registers is logged in the IOMMU event log and the upstream SMI request is discarded. The event log entry format used is the IO_PAGE_FAULT log buffer entry (Section 2.5.3 [IO_PAGE_FAULT Event]) with the Address[63:0] field set to the value addressed by the SMI interrupt request (see Table 4). Software must examine the Address field of the event log entry to determine if the logged interrupt request was an attempted SMI interrupt.

2.1.5.2 SMI Filter Address Format

For the purposes of the SMI filter, an SMI is defined as a posted write operation from a peripheral to an address of the format shown in Figure 3, derived from the Hypertransport™ specification. The SMI filter in the IOMMU does not process posted write operations generated by processors.

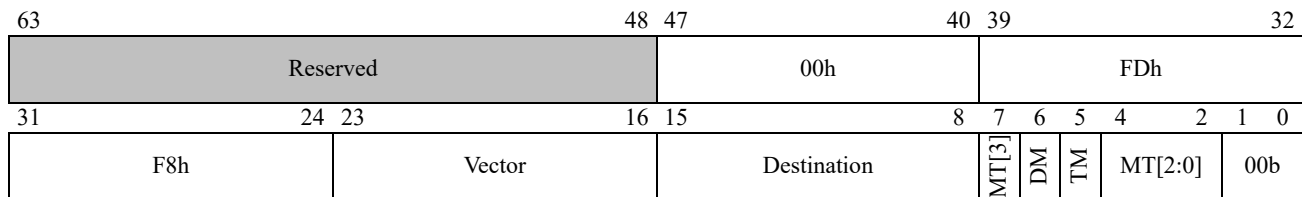

Figure 3: System Management Interrupt Address Format

Table 4: System Management Interrupt Address Fields

Bits	Value	Description
47:40	00h	MBZ : must be zero.
39:24	FDF8h	FDF8h : marks the interrupt region.
23:16	(ignored)	Vector : vector (ignored by the SMI filter).
15:8	(ignored)	Destination : destination (ignored by the SMI filter).
7	0b	MT[3] : Message Type[3].
6	0b	DM : Destination Mode.
5	(ignored)	TM : Trigger Mode (ignored by the SMI filter).
4:2	010b	MT[2:0] : Message Type [2:0].
1:0	00b	MBZ : must be zero.

2.1.5.3 Recommended Programming of the SMI Filter

The SMI filter registers are designed to be programmed by any software component. However, the system software currently available is not typically aware of SMI requests or the valid sources of SMI requests, so it does not have the information necessary to program the SMI filter. In the typical system hardware design, all SMI requests will be routed through a single source (typically a component called the baseboard management controller, or BMC) to be handled by firmware such as BIOS or UEFI. As a result, the SMI filter should be programmed by the firmware to handle a single source of SMI requests when the SMI filter is supported by the hardware (see MMIO Offset 0030h[SmiFSup]).

The recommended method to program the SMI filter is:

1. check that the SMI filter is supported (see [MMIO Offset 0030h\[SmiFSup\]](#)),
2. choose an SMI filter register to use from the available set (see [MMIO Offset 0030h\[SmiFRC\]](#)),
3. program the selected SMI filter register to the DeviceID of the BMC (see [MMIO Offset 00\[60-D8\]h\[SmiDID\]](#)),
4. program the selected SMI filter register to be valid (see [MMIO Offset 00\[60-D8\]h\[SmiDV\]](#)),
5. program the selected SMI filter register to be locked (see [MMIO Offset 00\[60-D8\]h\[SmiFLock\]](#)),
6. program any remaining SMI filter registers to be not-valid and locked, and
7. program [MMIO Offset 0018h\[SmiFLogEn\]](#) to disable SMI logging.

If the system software that processes the IOMMU event log is aware of the SMI filter, [MMIO Offset 0018h\[SmiFLogEn\]](#) should instead be programmed to enable SMI logging.

The more general case of programming the SMI filter registers is discussed in the following section.

2.1.5.4 General Programming of the SMI Filter Registers

When the IOMMU is reset, software must program the registers to make the SMI filter active. The optional SMI filter is implemented when [MMIO Offset 0030h\[SmiFSup\]](#) = 01b and enabled when software programs [MMIO Offset 0018h\[SmiFEn\]](#) = 1b. The SMI filter registers work as a set and the number of SMI filter registers implemented by an IOMMU is reported in [MMIO Offset 0030h\[SmiFRC\]](#) (see also [Table 77](#)). Each SMI filter register contains three fields: SmiDV, SmiDID, and SmiFLock (see [IOMMU SMI Filter Register \[MMIO Offset 00\[60-D8\]h\]](#)).

The values of SmiDID and SmiDV are read-only when SmiFLock = 1b and are read-write when SmiFLock = 0b. An SMI filter register containing SmiDV = 0b is inactive (never matches) and may be activated by programming SmiDV = 1b when SmiFLock = 0b; the entire SMI filter register may be programmed in one operation (i.e., software may set SmiDID, SmiDV = 1b and SmiFLock = 1b in the same operation). Software may lock an SMI filter register to be inactive by programming SmiDV = 0b and SmiFLock = 1b. Software may lock a value into an SMI filter register by programming SmiDID and SmiDV to the desired values and SmiFLock = 1b. Once locked, an SMI filter register can only be changed after a system reset sets SmiFLock = 0b.

An entry describing the blocked SMI interrupt request is optionally recorded in the IOMMU event log (see [MMIO Offset 0018h\[SmiFLogEn\]](#)). When logging is enabled, software can monitor the log entries to detect if excessive SMI interrupts are being received from an unexpected source device (DeviceID). When it detects excessive SMI interrupts, software can turn off the logging to reduce processing overhead. After software throttles or stops the source of the unexpected SMI interrupts, software can program [MMIO Offset 0018h\[SmiFLogEn\]](#) to resume the creation of event log notifications for SMI interrupts blocked by the SMI filter. The DTE and IRTE fields SA, SE, IG, and Supl-OPF do not affect logging of events from the SMI filter (see [Table 7](#) and [Table 20](#)).

To freeze a particular configuration of SMI filtering, program the SmiFLock=1b in each implemented SMI filter register.

System software that is not aware of SMI requests or the valid sources of SMI requests does not have the information necessary to program the SMI filter and the recommended programming procedure is

described in [Section 2.1.5.3 \[Recommended Programming of the SMI Filter\]](#).

In a more general system design, SMI requests may originate from multiple sources that are not limited to the baseboard management controller (BMC). The SMI filter can be programmed by the BIOS or UEFI to allow multiple sources of SMI requests when the SMI filter is supported by the hardware (see [MMIO Offset 0030h\[SmiFSup\]](#)). The procedure for this case is to:

1. check that the SMI filter is supported (see [MMIO Offset 0030h\[SmiFSup\]](#)),
2. for each expected source of SMI requests:
 - choose an SMI filter register to use from the available set (see [MMIO Offset 0030h\[SmiFRC\]](#)),
 - program the selected SMI filter register to the DeviceID of the peripheral (see [MMIO Offset 00\[60-D8\]h\[SmiDID\]](#)),
 - program the selected SMI filter register to be valid (see [MMIO Offset 00\[60-D8\]h\[SmiDV\]](#)),
 - program the selected SMI filter register to be locked (see [MMIO Offset 00\[60-D8\]h\[SmiFLock\]](#)),
3. reserve one or more of the remaining SMI filter registers to be unprogrammed and unlocked for use by the system software,
4. program remaining SMI filter registers not reserved for use by system software to be not-valid and locked,
5. program [MMIO Offset 0018h\[SmiFLogEn\]](#) to enable SMI logging so that system software is informed of SMI requests blocked by the SMI filter.

In this configuration, system software may program the unlocked SMI filter registers to allow SMI requests from additional peripherals. Software should be aware that once an SMI filter register is locked, it cannot be reprogrammed until the system is reset. System software and firmware will need to coordinate use of SMI filter registers using a method that is outside the scope this document.

2.2 Data Structures

Host software must maintain up to eight in-memory data structures for use by the IOMMU. These data structures are:

1. The *Device Table* is a table indexed by DeviceIDs. Each Device Table entry contains mode bits, a pointer to the I/O page tables, a pointer to an interrupt remapping control table, a set of control bits, and a 16-bit DomainID. The DomainID acts as an address space identifier, allowing multiple devices sharing the same I/O page tables to share the same translation cache resources on the IOMMU. The page tables must be the same for all devices that share a DomainID.
2. The *I/O page table(s)*: Each Device Table entry may specify a different I/O page table, or different Device Table entries may share the same I/O page tables. Each time the IOMMU processes a device access to memory, it looks up the device virtual address (DVA) in its translation cache and/or the appropriate I/O page tables to determine whether the device has permission, as well as (if permitted) the system physical address to access.
3. The *command buffer*: The IOMMU accepts commands queued by the processor through a circular buffer located in system memory.

4. The *event log*: The IOMMU reports atypical events to the processor by means of another circular buffer, the event log, located in system memory.
5. The *interrupt remapping table(s)*: Each Device Table entry may specify an interrupt remapping table. Each time the IOMMU processes a device interrupt request, it looks up the IRTE to remap the interrupt to the destination with a translated vector. (See Figure 15 on page 89 and Table 20 on page 89)
6. The *peripheral page request log*: The IOMMU can accept requests from PRI-capable peripherals to service page change requests. These requests are reported in a circular buffer, the PPR log, located in system memory.
7. The *guest virtual APIC tables*: The IOMMU can update guest interrupt request status.
8. The *guest virtual APIC log*: The IOMMU can report guest virtual interrupts sent to a guest that is not running.

Figure 4 illustrates the relationships among the IOMMU data structures.

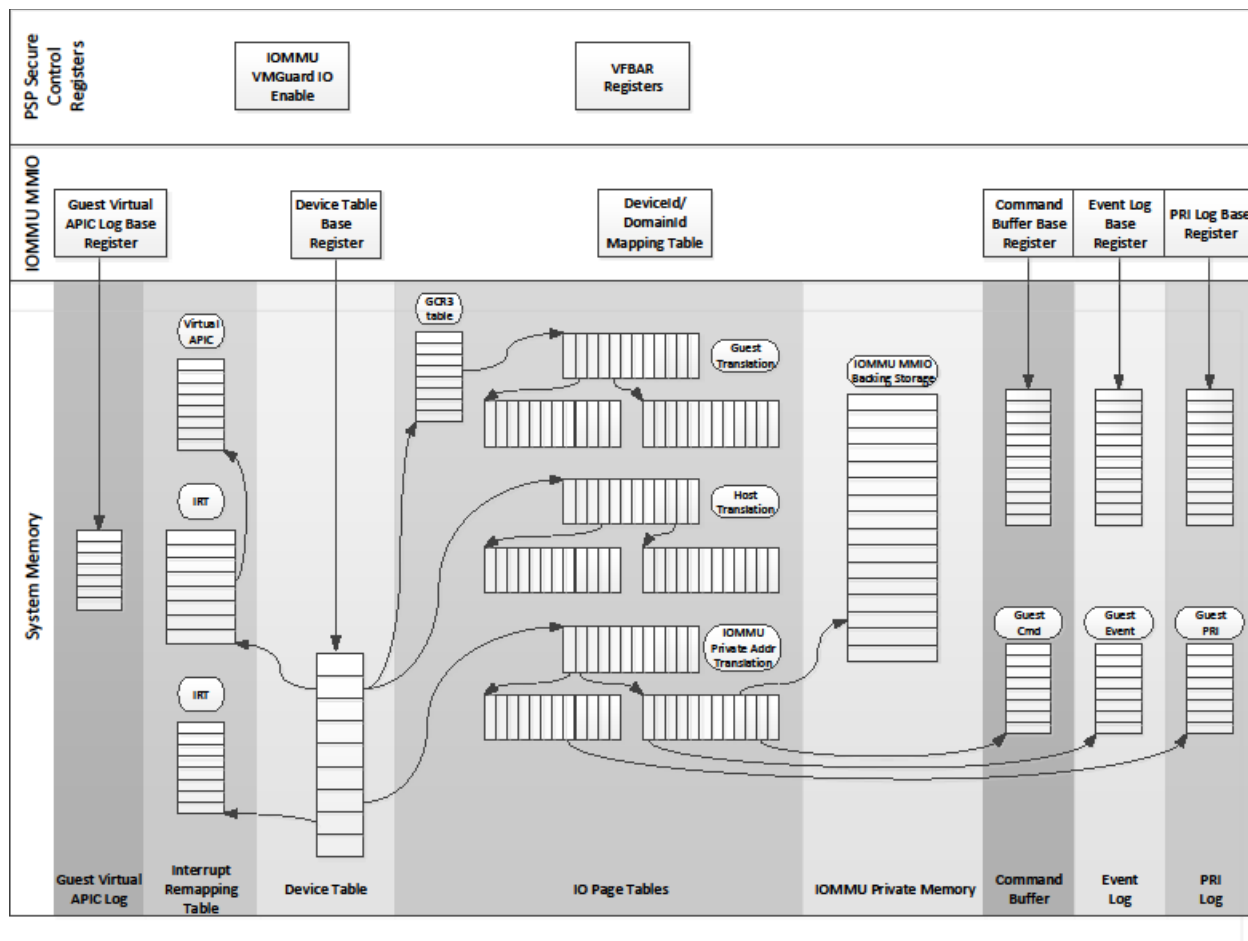

Figure 4: IOMMU Data Structures

The base functionality of the IOMMU supports one-level translation tables for address translation and

for interrupt remapping. The event log is the only data structure in system memory that is written by the IOMMU. The maximum size of a virtual address (GPA) is defined in [Capability Offset 10h\[VAsize\]](#) and the maximum size of a physical address (SPA) is defined in [Capability Offset 10h\[PAsize\]](#).

The IOMMU optionally supports both one-level and two-level translation tables ([Table 5](#)) as well as guest APIC virtualization, hardware error registers, performance counter registers, peripheral page-request services, x2APIC, and an SMI filter. An IOMMU can write to the event log, the peripheral page request log, the guest virtual APIC tables, the guest virtual APIC log, and the guest page tables. The maximum size of a guest virtual address (GVA) is defined in [Capability Offset 10h\[GVASize\]](#).

2.2.1 Updating Shared Tables

The I/O page table structures have been designed so they can be shared among processors and IOMMUs. The table structures (Interrupt Remapping Table, Device Table, and host I/O page tables) can be shared among IOMMUs.

The guest I/O page table structures are directly compatible with the AMD64 long mode page table format. IOMMU accesses can optionally update the tables so they can be shared with a processor. Shared tables have requirements for correct updates by system software.

When updating a table entry, system software is encouraged to use aligned 64-bit accesses although control bits are defined that allow system software updating a table to use byte accesses. Software should keep the page table content in a consistent state.

Each table can also have its contents cached by the IOMMU or peripheral IOTLBs. Therefore, after updating a table entry that can be cached, system software must send the IOMMU an appropriate invalidate command. Information in the peripheral IOTLBs must also be invalidated.

The IOMMU optionally supports hardware updates of Accessed and Dirty bits in guest page tables. The IOMMU is allowed to cache these bits, so software must issue invalidation commands when it clears the bits in memory.

2.2.2 Device Table

I/O devices that originate transactions are identified by a 16-bit DeviceID. The derivation of the DeviceID is fabric-dependent; for example, [Figure 5](#) shows how PCIe and PCI-X[®] RequesterIDs are mapped into IOMMU DeviceIDs and [Figure 6](#) shows how the data fabric UnitIDs are mapped into IOMMU DeviceIDs.

Software Note: the mapping of DeviceID from one bus to another is platform specific; consult the platform documentation for details.

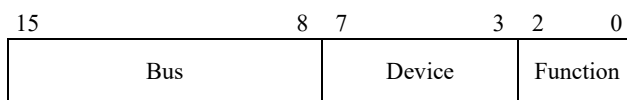
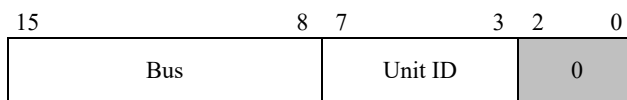

Figure 5: Example DeviceID Derived from Peripheral RequesterID

The number of bits allocated to the Bus, Device, and Function fields varies according to settings in the PCI configuration. The partitioning shown is a typical example.



Note: The I/O fabric bus number is located in the Slave/Primary Interface Block associated with the inbound link that supplies the data traffic.

Figure 6: DeviceID Derived from Peripheral UnitID

The Device Table is represented as an array of 256-bit entries with the DeviceID being used as an index into the array. Since there are 65,536 (64K) possible DeviceIDs, the Device Table can be up to 2 Mbytes in length. When Device Table segmentation is not supported or not enabled, space for the Device Table must be contiguous, although it can be less than 64K entries in length if it is known that 1 or more of the most-significant bits of the DeviceID are not used in the system.

The [Device Table Base Address Register \[MMIO Offset 0000h\]](#), controls the system physical address and size of the Device Table. The Device Table must be aligned on a 4-Kbyte boundary in system memory and must be a multiple of 4 Kbytes in length.

The IOMMU reads the entire Device Table entry in either two 128-bit transactions (as defined by the scope of the validity indicators) or a single 256-bit transaction.

When the IOMMU is enabled, any I/O device whose DeviceID is beyond the end of the Device Table is denied I/O permission (the IOMMU target aborts the access) and all attempted accesses by such I/O devices are logged when event logging is enabled. When PPR logging is supported, PRI requests are not validated using the Device Table and so the IOMMU may create a PPR log entry for an I/O device whose DeviceID is beyond the end of the Device Table when page requests are enabled (see [MMIO Offset 0018h\[PPREn\]](#)), so software must validate the DeviceID as part of PPR processing.

If an I/O device uses PCI phantom functions, software must replicate Device Table entries such that index calculations retrieve the correct entries for any phantom function used by the I/O device.

Device Table segmentation is an optional feature described in [Section 2.2.2.3 \[Device Table Segmentation\]](#) on page 76.

2.2.2.1 Device Table Entry Format

Device table entries have an address translation portion, an interrupt remapping portion, and an interrupt virtualization portion; control bits govern the use of each portion for a given DeviceID. The address translation portion has guest and nested translation portions that can be manipulated separately; guest translation cannot operate without nested translation.

The address translation features in [Table 5](#) may be implemented separately from the interrupt remapping and virtualization features in [Table 6](#); when implemented, address and interrupt features may be enabled and operated independently.

Table 5: Feature Enablement for Address Translation

GTSup (MMIO Offset 0030h)	GTEn (MMIO Offset 0018h)	Device Table Entry Address Translation Settings			Address Translation Features Available for Use
		V	TV	GV	
0	X	X	X	X	Host Translation supported; Guest Translation not supported.
1	0	X	X	X	Guest Translation supported, but not enabled.
1	1	0	X	X	Address for this DeviceID is passed untranslated.
1	1	1	0	X	Host page table entry for this DeviceID is not valid; Guest translation is not available for this DeviceID
1	1	1	1	0	Guest Translation can not be performed for this DeviceID because the guest page table entry is not valid.
1	1	1	1	1	Both Guest Virtual and Guest Physical Address translation is available and active for this Device ID.

Note: All encodings not listed are reserved.

Table 6: Feature Enablement for Interrupt Remapping and Virtualization

GASup (MMIO Offset 0030h)	GAEn (MMIO Offset 0018h)	IV (DTE)	GuestMod e (IRTE)	Interrupt Features Available for Use
0	X	X	X	Interrupt remapping only available.
1	0	X	X	Interrupt virtualization is supported, but not enabled.
1	1	0	0	Remapping is available, but not active for this DeviceID. Virtualization is available, but not active for the DeviceID.
1	1	1	0	Interrupt remapping is active for the DeviceID, but interrupt virtualization is not.
1	1	1	1	Interrupt remapping and virtualization are active for the DeviceID.

The Device Table entry (DTE) format is shown in Figure 7.

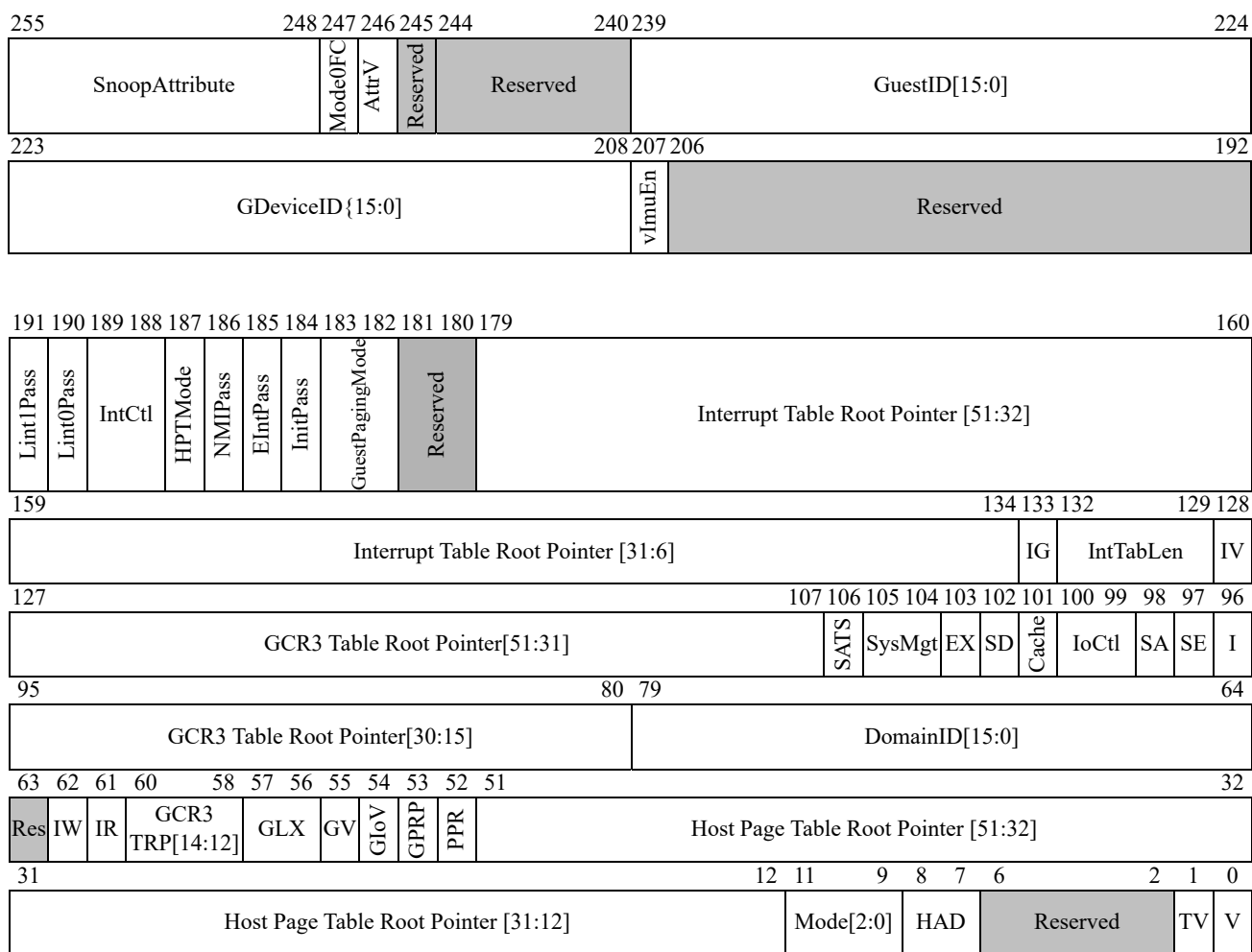

Figure 7: Device Table Entry (DTE) Fields

Fields in the Device Table entry are defined in Table 7. Where indicated in Table 7, events are reported as described in Section 2.5.2 [ILLEGAL_DEV_TABLE_ENTRY Event]. Shaded areas mark fields that are reserved.

Table 7: Device Table Entry (DTE) Field Definitions

Bits	Description
255:248	<p>SnoopAttribute. If AttrV=1, a 3-bit index is generated from the guest page table and used to select one bit from the SnoopAttribute field to help set the N field in guest ATS responses. If the indexed SnoopAttribute bit is set to 1, the N field is also set to 1. If the indexed SnoopAttribute bit is set to 0, the FC field is used to set the N field. In AMD64 systems, the 3-bit index is generated using {PAT, PCD, PWT} from the guest PTE.</p> <p>This field is meaningful when V=1, TV=1, GV=1, AttrV=1 and MMIO Offset 0030h[AttrFWSup]=1, otherwise it must be set to zero.</p>
247	<p>Mode0FC. This field is used in place of the host PTE.FC field when DTE.Mode=0 for untranslated DMA requests and guest ATS requests. If Mode0FC=1 the ATS N field is set to 1 in a guest ATS response. The ATS device must clear the NoSnoop attribute when generating DMA using the returned translation. For untranslated DMA, the IOMMU clears the PCIe NoSnoop attribute if Mode0FC=1.</p> <p>This field is meaningful when V=1, TV=1, GV=1, AttrV=1, Mode=0 and MMIO Offset 0030h[AttrFWSup]=1, otherwise it must be set to zero.</p>
246	<p>AttrV: attribute override valid. 1=The Mode0FC and SnoopAttribute fields are valid and are used to set the N (No-snooped accesses) attribute in guest ATS responses. 0=The Mode0FC and SnoopAttribute fields are invalid and are not used to modify transaction attributes. They must be set to 0. Guest ATS responses are returned with N=0. The device may choose how to set NoSnoop when generating DMA using the returned translation.</p> <p>This field is meaningful when V=1, TV=1, GV=1 and MMIO Offset 0030h[AttrFW-Sup]=1, otherwise it must be set to zero.</p>
245	<p>Reserved. This field is reserved and must be set to zero.</p> <p>No reserved field check is performed if MMIO Offset 0030h[SNPSup]=1.</p>
244:240	Reserved.
239:224	<p>GuestID[15:0]: This GuestID is a 16 bit value which the host software assigns to each individual guest in the system. Multiple devices can be assigned under the same guest. This field is meaningful when V=1, TV=1, GV=1, vImuEn=1 and MMIO[vIommuEn]=1, otherwise it must be set to zero.</p>
223:208	<p>GDeviceID[15:0]: Guest DeviceID. The GDeviceID is a 16 bit device ID the guest software assigned cross all the devices under the same guest. The guest deviceID assignment can be different from the host deviceID. This field is meaningful when V=1, TV=1, GV=1, vImuEn=1 and MMIO[vIommuEn]=1, otherwise it must be set to zero.</p>

Table 7: Device Table Entry (DTE) Field Definitions (Continued)

Bits	Description
207	vImuEn: virtualize IOMMU enabled. When vImuEn=1, the device is assigned under a guest which enables IOMMU virtualization (viommu enabled guest). This field is meaningful when V=1, TV=1, GV=1 and MMIO[vIommuEn]=1, otherwise it must be set to zero.
206:192	Reserved. Reserved non-zero bits in this field are reported as an event IV=1.
191	Lint1Pass: LINT1 (legacy PIC NMI) pass-through. This bit enables device initiated LINT1 interrupts to be forwarded by the IOMMU. 1=Device initiated LINT1 interrupts are forwarded unmapped. 0=Device initiated LINT1 interrupts are target aborted by the IOMMU. See Table 10 .
190	Lint0Pass: LINT0 (legacy PIC ExtInt) pass-through. This bit enables device initiated LINT0 interrupts to be forwarded by the IOMMU. 1=Device initiated LINT0 interrupts are forwarded unmapped. 0=Device initiated LINT0 interrupts are target aborted by the IOMMU. See Table 10 .
189:188	IntCtl: Interrupt control. This field controls how fixed and arbitrated interrupt messages are handled. Fixed and arbitrated interrupt messages use an architecture specific special address as shown in Table 3 and Table 19 . 00b=Fixed and arbitrated interrupts target aborted 01b=Fixed and arbitrated interrupts are forwarded unmapped 10b=Fixed and arbitrated interrupts remapped 11b=Reserved See Table 9 . If IntCtl=10b, a valid interrupt table root pointer must be present; if not(IntCtl=10b) the interrupt table root pointer is ignored. <i>Note: IntCtl=11b is reported as an event when IV=1.</i>
187	HPTMode: Host Page Table Mode Hint. IOMMU implementations may be able to optimize performance related to secure IOTLB requests when software provides guarantees related to the host page table for the associated device. 1=Host page table data structures for this device are guaranteed by software to be pinned and present in memory. 0=Host page table data structures (PDEs and PTEs) for this device may be pageable and not always present. IOMMU may indicate that the page is not accessible in response to IOTLB requests and devices may be required to issue Peripheral Page Requests in order to obtain access to the memory. This bit is reserved and must be set to 0 when MMIO Offset 0030h [SATSSup]=0.
186	NMIPass: NMI pass-through. 1=pass through NMI interrupt messages unmapped. 0=NMI interrupt message is target aborted by the IOMMU. See Table 10 .
185	EIntPass: ExtInt pass-through. 1=pass through ExtInt interrupt messages unmapped. 0=External interrupt message is target aborted by the IOMMU. See Table 10 .

Table 7: Device Table Entry (DTE) Field Definitions (Continued)

Bits	Description
184	InitPass: INIT pass-through. 1=pass through INIT interrupt messages unmapped. 0=INIT interrupt message handling target aborted by the IOMMU. See Table 10 .
183:182	GuestPagingMode: When Guest Translation is enabled for this device, GuestPaging-Mode indicates the start level of the Guest Page Table. 00b: Start Level is 4, which contains PML4E Entries. 01b: Start Level is 5, which contains PML5E Entries. 10b and 11b: Reserved The GuestPagingMode value is ignored when GV=0. Must be zero when MMIO Offset 0030h[GTSup]=0 .
181:180	Reserved
179:134	Interrupt table root pointer. The interrupt table root pointer is only used when interrupt translation is enabled (IntCtl=10b). It contains the SPA of the base address of the interrupt remapping table for the I/O device. The interrupt remapping table must be aligned to start on a 128-byte boundary.
133	IG: ignore unmapped interrupts. 1=Suppress event logging for interrupt messages causing IO_PAGE_FAULT events. 0=creation of event log entries for IO_PAGE_FAULT events is controlled by SupIOPF in the interrupt remapping table entry (see Section 2.2.5 [Interrupt Remapping Tables]).
132:129	IntTabLen: interrupt table length. This field specifies the length of the interrupt remapping table. 0000b = 1 entry 0001b = 2 entries 0010b = 4 entries 0011b = 8 entries ... 1010b = 1024 entries 1011b = 2048 entries 11xxb = reserved <i>Note: IntTabLen=11xxb is reported as an event when IV=1.</i>
128	IV: interrupt map valid. See Table 9 and Table 10 .
127:107	GCR3 Table Root Pointer[51:31]. When guest translations are supported, this field contains the SPA of the guest CR3 table for the I/O device. The guest CR3 table root pointer may be used by hardware when V=1 and TV=1 and GV=1; it is ignored otherwise. See Section 2.2.6 [I/O Page Tables for Guest Translations] .
106	SATS: Secure ATS. 1 = ATS requests are processed as secure ATS requests. 0 = ATS requests are processed as non-secure ATS requests. When Secure Nested Paging is enabled, software must set SATS=1 when I=1. This bit is reserved when I=0 or MMIO Offset 0030h[SATSSup]=0 .

Table 7: Device Table Entry (DTE) Field Definitions (Continued)

Bits	Description
105:104	<p>SysMgt: system management message enable. Specifies whether device-initiated untranslated memory requests that target the system management address space in Table 3 are blocked, forwarded, or translated by the IOMMU.</p> <p>00b=Device initiated DMA transactions in the system management address range are return target abort status by the IOMMU. Translation requests return target abort status.</p> <p>01b=Device initiated system management messages, including INTx messages, are forwarded untranslated by the IOMMU. Upstream reads or non-posted writes return target abort status. Translation requests return target abort status.</p> <p>10b=Device initiated INTx messages are forwarded by the IOMMU untranslated; device initiated system management messages other than INTx messages return target abort status. Upstream reads and non-posted writes return target abort status. Translation requests return target abort status.</p> <p>11b=Device initiated DMA transactions in the system management address range are translated by the IOMMU.</p>
103	<p>EX: allow exclusion. 1=Accesses from this device that address the IOMMU exclusion range are excluded from translation and access checks. 0=Accesses from this device to the IOMMU exclusion range are translated and checked for access rights. See IOMMU Exclusion Base Register / Completion Store Base Register [MMIO Offset 0020h] and IOMMU Exclusion Range Limit Register / Completion Store Limit Register [MMIO Offset 0028h].</p>
102	<p>SD: snoop disable. 1=IOMMU page table walk transactions for this device are not snooped. Data fabric transactions by an IOMMU must not set the coherent bit in page table walk requests for this device. Software must synchronize page table updates.</p> <p>0=IOMMU page table walk transactions for this device are snooped. HyperTransport™ transactions by an IOMMU must set the coherent bit in page table walk requests for this device. See also the Coherent bit in the IOMMU Control Register [MMIO Offset 0018h].</p>
101	<p>Cache: IOTLB cache hint. 1=the IOMMU avoids caching GPA-to-SPA translation information obtained for ATS requests. 0=the IOMMU caches GPA-to-SPA translation information obtained for ATS requests when the peripheral is directed to issue untranslated addresses (see Table 12). For ATS requests containing a GVA, the IOMMU optionally caches translation information and sets U=0 in an ATS response.</p> <p><i>Software Note:</i> It is recommended that software set Cache=0 for peripherals with an IOTLB.</p> <p>1=Caching of translations for explicit translation requests is not recommended. See Section 2.2.7.3 [Recalculating Read and Write Access Permissions].</p>

Table 7: Device Table Entry (DTE) Field Definitions (Continued)

Bits	Description
100:99	<p>IoCtl: Port I/O control. Specifies whether device-initiated port I/O space transactions are blocked, forwarded, or translated.</p> <p>00b=Device-initiated port I/O is not allowed. The IOMMU target aborts the transaction if a port I/O space transaction is received. Translation requests are target aborted.</p> <p>01b=Device-initiated port I/O space transactions are allowed. The IOMMU must pass port I/O accesses untranslated. Translation requests are target aborted.</p> <p>10b=Transactions in the port I/O space address range are translated by the IOMMU page tables as memory transactions.</p> <p>11b=Reserved.</p> <p><i>Note:</i> <i>IoCtl=00b and IoCtl=01b control the forwarding upstream of port I/O, if it is implemented.</i></p> <p><i>Note:</i> <i>IoCtl=11b is reported as an event when V=1.</i></p>
98	<p>SA: Suppress all I/O page fault events. 1=Suppress event logging for all IO_PAGE_FAULT events caused by memory accesses from this I/O device. See also the SupIOPF control in the IRTE (Table 20).</p> <p><i>Note:</i> <i>SA does not affect events logged due to interrupts or IOMMU command processing.</i></p> <p><i>Note:</i> <i>When V=0 the value of SA is ignored by the IOMMU.</i></p> <p><i>Note:</i> <i>SmiFLogEn independently controls the creation of IO_PAGE_FAULT log entries generated by the SMI filter (see Section 1.3.10 [SMI Filter]).</i></p>
97	<p>SE: suppress I/O page fault events. Suppress event logging for IO_PAGE_FAULT events if an IO_PAGE_FAULT event has already been logged in the event log for this I/O device. 1=The IOMMU must only update the event log with an IO_PAGE_FAULT event for the first page fault seen for the device as long as the DeviceID remains in the IOMMU cache. The IOMMU clears all state associated with this bit when an INVALIDATE_DEVTAB_ENTRY command is received for the device or when the DeviceID is replaced in the cache by a different DeviceID. See also the SupIOPF control in the IRTE (Table 20).</p> <p><i>Software Note:</i> <i>The SE bit controls a mechanism that reduces the number of event log entries on a per-device basis. The degree of filtering depends on the behavior of the Device Table cache. As such, software should not assume that only a single entry per device is made in the event log.</i></p> <p><i>Note:</i> <i>SE does not affect events logged due to interrupts or IOMMU command processing.</i></p> <p><i>Note:</i> <i>When V=0 the value of SE is ignored by the IOMMU.</i></p> <p><i>Note:</i> <i>SmiFLogEn independently controls the creation of IO_PAGE_FAULT log entries generated by the SMI filter (see Section 1.3.10 [SMI Filter]).</i></p>
96	<p>I: IOTLB enable. Controls IOMMU response to address translation requests from peripherals. 0=IOMMU returns target abort status when it receives an ATS requests from the peripheral. 1=IOMMU responds to ATS requests from the peripheral. This bit does not affect interrupts from the peripheral. If I=1 when Capability Offset 00h[IotlbSup]=0, the results are undefined.</p>

Table 7: Device Table Entry (DTE) Field Definitions (Continued)

Bits	Description
95:80	GCR3 Table Root Pointer[30:15] . When guest translations are supported, this field contains the SPA of the top (or only) level of the guest CR3 table for the peripheral. The guest CR3 table root pointer may be used by hardware when V=1 and TV=1 and GV=1. See Section 2.2.6 [I/O Page Tables for Guest Translations] . Must be zero when MMIO Offset 0030h[GTSup]=0.
79:64	DomainID . The DomainID is a 16-bit integer chosen by software that the IOMMU must use to tag its internal translation caches and to mark event log entries. I/O devices with different page tables must be given different DomainIDs. I/O devices that share the same page tables may be given the same DomainID. I/O devices that share the same DTE[DomainID] must have the same settings in the DTE[Mode] and page table root pointer fields, however they may have different values in the DTE[I] and DTE[SysMgt] fields. If devices with the same DTE[DomainID] are given different non-zero values in the DTE[Mode] field or different page table root pointer values, the behavior of the IOMMU is undefined. The value of the DTE[DomainID] recorded in an event log entry is undefined when V=0 and IV=1.
63	Reserved. <i>Note: A non-zero value in this field is reported as an event when V=1.</i>
62	IW : I/O write permission. Used in the calculation of effective write access with the permission bits in the page tables; if there are no page tables (DTE[Mode]=000b), then this bit defines the I/O write permission. 1=I/O device is allowed to perform DMA write transactions and 0-byte read transactions (see Section 2.1.4 [Special Conditions]); the I/O device is allowed to perform DMA atomic operations when IR is also programmed to allow read access. 0=Device initiated DMA write and atomic transactions are target aborted.
61	IR : I/O read permission. Used in the calculation of effective read access with the permission bits in the page tables; if there are no page tables (DTE[Mode]=000b), then this bit defines the I/O read permission. 1=I/O device is allowed to perform DMA read transactions; the I/O device is allowed to perform atomic transactions when IW is also programmed to allow write operations. 0=Device initiated DMA read transactions are target aborted. When both IW and IW are programmed to 0b, device-initiated 0-byte read transactions are target aborted.
60:58	GCR3 TRP : guest CR3 table root pointer[14:12]. When guest translations are supported, this field contains the SPA or GPA (depending on MMIO Offset 0018h[GCR3TRPMode]) of the top (or only) level of the guest CR3 table for the I/O device. The guest CR3 table root pointer may be used by hardware when V=1 and TV=1 and GV=1. See Section 2.2.6 [I/O Page Tables for Guest Translations] . Must be zero when MMIO Offset 0030h[GTSup]=0.

Table 7: Device Table Entry (DTE) Field Definitions (Continued)

Bits	Description
57:56	<p>GLX: guest levels translated. When guest translations are supported, this field specifies the type of guest CR3 lookup performed by the IOMMU for the I/O device when the device presents an address with a valid PASID. 00b=GCR3 table is single-level. 01b=GCR3 table is two-level. 10b=GCR3 table is three-level. 11b=reserved. The GLX value is ignored when GV=0. See Table 11 and Section 2.2.6.3 [Guest CR3 Table]. Must be zero when MMIO Offset 0030h[GTSup]=0.</p> <p>Implementation Note: The number of levels in a guest CR3 table supported by hardware is indicated by MMIO Offset 0030h[GLXSup].</p> <p>Software Note: For a peripheral using PASID values up to 9 bits, software may program GLX=00b and build one-level GCR3 tables. For a peripheral using PASID values that use more than 9 bits but fewer than 19 bits, software must program GLX=01b and build two-level GCR3 base address tables. For a peripheral using PASID values that use 19 or 20 bits, software must program GLX=10b and build three-level GCR3 base address tables.</p>
55	<p>GV: guest translation valid. When guest translations are supported, this field controls guest-level translation. 0=IOMMU performs GPA-to-SPA translation only; GLX and the GCR3 table root pointer fields are ignored. 1=IOMMU performs GPA-to-SPA translation or GVA-to-SPA when a valid PASID is provided; GLX and the GCR3 table root pointer values are used for GVA-to-GPA translations. Software programs this bit when guest page translation is available (see Table 5). This bit is meaningful when V=1 and TV=1 and MMIO Offset 0030h[GTSup]=1. Must be zero when MMIO Offset 0030h[GTSup]=0.</p>
54	<p>GloV: guest I/O protection valid. This field indicates whether guest I/O protection is enabled for the I/O device. 1=Requests from the I/O device without a PASID are treated as if they have PASID of 0. Guest translation is performed if enabled. 0=Requests from the I/O device without a PASID are not modified. Only host translation is performed.</p> <p>This bit is meaningful when V=1, TV=1, GV=1 and MMIO Offset 0030h[GIoSup]=1. Must be zero when MMIO Offset 0030h[GIoSup]=0 otherwise an error will be reported when V=1.</p> <p>MMIO Offset 0030h[EPHSup] must be set if the device supports PRI and using the Guest I/O protection feature.</p>
53	<p>GPRP: guest PPR response with PASID. This field controls whether a PASID is returned as part of a guest auto PPR response. 1=Auto PPR response is sent with a PASID if the PPR request had a PASID. 0=All auto PPR responses are sent without PASID. See Section 2.6.4.1 [PPR Auto Response] on page 179. It is recommended for OS supporting Page Requests for SVM to set the bit to 1.</p> <p>This bit is meaningful when V=1, TV=1, GV=1 and MMIO Offset 0030h[EPHSup]=1. Must be zero when MMIO Offset 0030h[EPHSup]=0 otherwise an error will be reported when V=1.</p>

Table 7: Device Table Entry (DTE) Field Definitions (Continued)

Bits	Description
52	<p>PPR: PPR enable. This field controls whether the PPR requests are enabled. 1=I/O device is allowed to generate PPR requests. IOMMU will copy these into the PPR log if the log is enabled. 0=I/O device is not allowed to generate PPR requests. PPR requests are dropped and INVALID_PPR_REQUEST is logged.</p> <p>This bit is meaningful when V=1 and MMIO is Offset 0030h[EPHSup] = 1. Must be zero when MMIO Offset 0030h [EPHSup] = 0 otherwise an error will be reported when V=1.</p>
51:12	<p>Page Table Root Pointer. The page table root pointer contains the system physical address of the root page table for the I/O device for GPA-to-SPA translations. The pointer is only used in modes where GPA-to-SPA translation is enabled.</p>
11:9	<p>Mode: paging mode. Specify how the IOMMU performs GPA-to-SPA translation on behalf of the device. If GPA-to-SPA translation is enabled, this field specifies the depth of the host page tables associated with the device (see page table root pointer).</p> <p>000b Translation disabled (Access controlled by IR and IW bits. SPA=GPA.)</p> <p>001b : 1 Level Page Table (provides a 21-bit GPA space)</p> <p>010b : 2 Level Page Table (provides a 30-bit GPA space)</p> <p>011b : 3 Level Page Table (provides a 39-bit GPA space)</p> <p>100b : 4 Level Page Table (provides a 48-bit GPA space)</p> <p>101b : 5 Level Page Table (provides a 57-bit GPA space)</p> <p>110b : 6 Level Page Table (provides a 64-bit GPA space)</p> <p>111b : Reserved</p> <p><i>Note: the page table root pointer for GPA-to-SPA translation is ignored when Mode=000b and when Mode=111b.</i></p> <p><i>Note: Mode=111b is reported as an event when V=1 and TV=1. See also MMIO Offset 0030h[HATS].</i></p>
8:7	<p>HAD: Host Access Dirty. Controls whether the IOMMU updates the Access and Dirty bits in the host page table.</p> <p>00b = IOMMU does not set the Access and Dirty bits in the host page table</p> <p>01b = IOMMU sets Access bits in the host page table corresponding to peripheral requests</p> <p>10b = Reserved</p> <p>11b = IOMMU sets the Access and Dirty bits in the host page table corresponding to peripheral requests. This encoding is reserved if MMIO Offset 0030h[HDSup]=0.</p> <p>This field is meaningful when V=1, TV=1 and MMIO Offset 0030h[HASup]=1 otherwise it must be set to zero.</p>
6:2	Reserved. Non-zero bits in this field are reported as an event when V=1.

Table 7: Device Table Entry (DTE) Field Definitions (Continued)

Bits	Description
1	TV: translation information valid. 1=Page translation information is valid, specifically IW, IR, the page table root pointer, Mode, and GV. 0=Page translation information is not valid. TV is not meaningful when V=0. See Table 8 .
0	V: valid. 1=Device table entry bits [127:1] are valid. 0=Device table entry bits [127:1] are invalid and transactions not intercepted by the interrupt remapping portion of the IOMMU are passed through. <i>Note:</i> Interrupt remapping portion of the Device Table entry is controlled by the IV bit. Software note: DomainID must be valid when V=1. See Table 8 .

The interactions of the V, TV, IV, and IntCtl control bits are stated in [Table 8](#) and [Table 9](#). The interactions of IV and the pass control bits are defined in [Table 10](#). The event log entries for operations causing a target abort are defined in [Section 2.5 \[Event Logging\]](#).

Table 8: V, TV, and GV Fields in Device Table Entry

V	TV	GV	Description
0	X	X	All addresses are forwarded without translation; individual control fields are ignored.
1	0	0	The SysMgt, EX, SD, Cache, IoCtl, SA, SE, and I fields are valid. The value of DomainID is used for event log entries. If the request requires a table walk, the table walk is terminated. The Mode and Host Page Table Root Pointer fields are ignored. When guest translation is supported, the GV, GLX, GCR3 Table Root Pointer fields are ignored.
1	0	1	The SysMgt, EX, SD, Cache, IoCtl, SA, SE, and I fields are valid. The value of DomainID is used for event log entries. If the request requires a table walk, the table walk is terminated. The Mode, Host Page Table Root Pointer, GV, GLX, GCR3 Table Root Pointer fields are ignored. If GTsup = 0, this setting results in ILLEGAL_DEV_TABLE_ENTRY event (see Section 2.5.2 [ILLEGAL_DEV_TABLE_ENTRY Event]).
1	1	0	All fields in bits [127:2] are valid and GPA-to-SPA translation is active (see Section 2.2.6 [I/O Page Tables for Guest Translations]).
1	1	1	All fields in bits [127:2] are valid and GVA-to-SPA translation is active (see Section 2.2.6 [I/O Page Tables for Guest Translations]). If GTsup = 0, this setting results in ILLEGAL_DEV_TABLE_ENTRY event.

Table 9: IV and IntCtl Fields in Device Table Entry for Fixed and Arbitrated Interrupts

IV	IntCtl	Description
0	X	All interrupts are forwarded without remapping.
1	00b	All fixed and arbitrated interrupts are target aborted.

Table 9: IV and IntCtl Fields in Device Table Entry for Fixed and Arbitrated Interrupts

IV	IntCtl	Description
1	01b	All fixed and arbitrated interrupts are forwarded without remapping.
1	10b	All fixed and arbitrated interrupts are remapped.
1	11b	Behavior undefined.

Table 10: IV and Pass Fields in Device Table Entry for Selected Interrupts

IV	Pass Field Name	Pass Field=0b	Pass Field=1b
0	X	LINT0, LINT1, SMI, NMI, INIT, and ExtInt interrupts are passed through unmapped.	
1	X	SMI interrupts are passed through unmapped. There is no pass field to control SMI requests. See instead Section 1.3.10 [SMI Filter] .	
1	Lint0Pass	LINT0 interrupts are target aborted.	LINT0 interrupts are passed through unmapped.
1	Lint1Pass	LINT1 interrupts are target aborted.	LINT1 interrupts are passed through unmapped.
1	NMIPass	NMI interrupts are target aborted.	NMI interrupts are passed through unmapped.
1	INITPass	INIT interrupts are target aborted.	INIT interrupts are passed through unmapped.
1	EIntPass	ExtInt interrupts are target aborted.	ExtInt interrupts are passed through unmapped.

Table 11: GLX and Maximum Translatable PASID size

MMIO Offset 0030h GTSup	MMIO Offset 0030h GLXSup	DTE[GV] (see Table 8)	DTE[GLX]	Maximum translatable PASID size (bits)	Levels in GCR3 table
0	X	X	XXb	none	-
1	X	0	XXb	none	-
1	X	1	11b	not defined	-
1	00b	1	00b	9	1
1	00b	1	01b, 10b	not defined	-
1	01b	1	00b	9	1
1	01b	1	01b	18	2
1	01b	1	10b	not defined	-

Table 11: GLX and Maximum Translatable PASID size (Continued)

MMIO Offset 0030h GTSup	MMIO Offset 0030h GLXSup	DTE[GV] (see Table 8)	DTE[GLX]	Maximum translatable PASID size (bits)	Levels in GCR3 table
1	10b	1	00b	9	1
1	10b	1	01b	18	2
1	10b	1	10b	20	3

Table 12: Cache bit and U bit for ATS requests

U (I/O PTE, Table 17)	Cache (DTE, Table 7)	IOMMU behavior (advised)	Comments
0	X	IOMMU not advised to cache results from ATS request	The peripheral issues pretranslated addresses (SPA) for read, write, and atomic operations; the IOMMU is not likely to need translation information.
1	0	IOMMU is advised to cache results from ATS requests	The peripheral issues untranslated addresses (GVA or GPA) for read, write, and atomic operations; the IOMMU needs translation information to process the memory transactions.
1	1	IOMMU not advised to cache results from ATS requests	The peripheral issues untranslated addresses (GVA or GPA) for read, write, and atomic operations. Note that the IOMMU is likely to walk page tables to obtain the needed translation information.

Implementation Note: An ATS response for a GVA always returns U=0 (see Table 17) and software must account for this when deciding if an invalidation operation is required.

Note: For more information on the U bit, see the PCI Address Translation Services 1.1 Specification.

Although Table 11 defines the maximum PASID size that can be translated using a GCR3 table, MMIO Offset 0030h[PASmax] defines the maximum PASID size that can be handled internally by the IOMMU. Figure 21 and Figure 23 illustrate the structure of 1- and 2-level GCR3 tables, respectively. Guest address translation control fields are in Table 24.

Table 12 defines the caching behavior of the IOMMU based on the per-device Cache bit in the DTE and the per-page U bit in the PTE. In the PCI Address Translation Services 1.1 Specification, the U bit defines whether the peripheral can issue translated or untranslated addresses to access a page for read, write, or atomic operations. When PTE[U]=1, software can use the Cache bit in the DTE to provide a

caching hint to the IOMMU.

2.2.2.2 Making Device Table Entry Changes

This section contains information for software that changes the IOMMU tables. Software should issue invalidate commands after certain types of changes to tables and note that I/O device accesses are neither queued nor throttled by the IOMMU. Software may change the interrupt remapping information independently of the address translation information in a Device Table entry. These operational sequences are general and system conditions may allow optimizations. Device table entry changes may affect guest OS I/O behavior, after invalidation commands have issued.

Software may change the interrupt remapping information in a Device Table entry with a single 64-bit write. The change must be followed by an `INVALIDATE_DEVTAB_ENTRY` command when either the value of `IV=1b` or the value of `V=1b` before the change. If a 64-bit operation cannot be used, software may change the interrupt remapping information in the Device Table entry in the following manner, according to the value of `IV` before the change in the relevant Device Table entry.

- If `IV=0b` before the change, changes can be made in any order as long as the last change is to set to `IV=1b`; an `INVALIDATE_DEVTAB_ENTRY` command is required when the `V=1b` before the change.
- If `IV=1b` before the change, the following steps may be followed to change interrupt remapping information for fixed and arbitrated interrupts:
 - Set `IntCtl=00b` in the Device Table entry to block interrupts; any device-initiated interrupts for the domain are target aborted and, when enabled, logged to the event log.
 - Update the interrupt table root pointer, `IG`, and `IntTabLen`.
 - Invalidate the interrupt table if the interrupt table root pointer or `IntTabLen` was changed (see [Section 2.4.5 \[INVALIDATE_INTERRUPT_TABLE\]](#)).
 - Change `IntCtl` to cease blocking interrupts from the device (set `IntCtl=01b` or `10b`).
 - Invalidate the Device Table entry (see [Section 2.4.2 \[INVALIDATE_DEVTAB_ENTRY\]](#)).
- If `IV=1b` before the change, the following steps change interrupt control information in the Device Table entry for `NMI`, `LINT0`, `LINT1`, `INIT`, and `EXTINT` interrupts:
 - Update `Lint1Pass`, `Lint0Pass`, `IntCtl`, `NMIPass`, `EIntPass`, and `InitPass`. The setting of `IntCtl` can be changed at the same time.
 - Invalidate the Device Table entry for the device (see [Section 2.4.2 \[INVALIDATE_DEVTAB_ENTRY\]](#)).

Software may change the address translation information in a Device Table entry with a single 128-bit write operation followed by an `INVALIDATE_DEVTAB_ENTRY` command when either `IV=1b` or `V=1b` before the change. If a 128-bit operation cannot be used, software may change the address translation information in the following ways, according to the values of `V` and `TV` before the change.

- If `V=0b` before the change, address translation changes can be made in any order as long as the last change is to set `V=1b`. An `INVALIDATE_DEVTAB_ENTRY` command is required if `IV=1b` before the change.
- If `V=1b` before the change, software can use the following steps to set the IOMMU to pass addresses untranslated with access controlled by `IR` and `IW`, depending on the value of `TV`.

- If TV=0b before the change, set values for IW, IR, Mode=000b, and TV=1b (maintaining V=1b), then issue an INVALIDATE_DEVTAB_ENTRY command. If not done as a 64-bit write, the values of TV and V must be in the final change. Note that the DomainID and other values in bits [127:96] are already valid because V=1b.
- If TV=1b before the change, software must change IW and IR concurrent with or before changing Mode and the values of TV and V must be in the final change. Software then issues an INVALIDATE_DEVTAB_ENTRY command.

The IOMMU optionally supports hardware updates of Accessed and Dirty bits in page tables. The IOMMU is allowed to cache these bits, so software must issue invalidation commands when it clears the A or D bit in memory.

2.2.2.3 Device Table Segmentation

Device Table segmentation is an optional feature that allows the Device Table to be divided into 2, 4, or 8 smaller tables that can be independently located in the system physical address space. This capability to divide the table into smaller allocation blocks makes it easier to fit the table into system memory and can make it possible to allocate less total memory space for the Device Table in situations where the DeviceID space is sparsely populated.

The two-bit field DevTblSegSup of the [IOMMU Extended Feature Register \[MMIO Offset 0030h\]](#) indicates the number of segments supported by a given implementation. When the value of DevTblSegSup = 00b, Device Table segmentation is not supported and the [Device Table Base Address Register \[MMIO Offset 0000h\]](#) controls the location and size of the single, unified Device Table.

When DevTblSegSup > 00b, [Device Table Base Address Register \[MMIO Offset 0000h\]](#) defines the location and size of the first ($n = 0$) segment and additional Device Table Base Address registers are supported. The architecture defines seven Device Table Segment n Base Address registers located at MMIO Offsets 100–130h. See [Device Table Segment \$n\$ Base Address Register \[MMIO Offset 01\[00–30\]h\]](#) for details on the layout of these registers.

The number of segments enabled is controlled by the 3-bit DevTblSegEn field of the [IOMMU Control Register \[MMIO Offset 0018h\]](#). [Table 13](#) shows the registers used to define the location and size of each Device Table segment based on the number of segments enabled using the DevTblSegEn field.

Table 13: Registers Utilized to Allocate Device Table Segments

DevTblSegEn	Number of Active Segments	Segment Number	Device Table Base Address Registers Utilized (MMIO Offset)
000b	1	0	Device Table Base Address Register (0000h)
001b	2	0	Device Table Base Address Register (0000h)
		1	Device Table Segment 1 Base Address Register (0100h)

Table 13: Registers Utilized to Allocate Device Table Segments (Continued)

DevTblSegEn	Number of Active Segments	Segment Number	Device Table Base Address Registers Utilized (MMIO Offset)
010b	4	0	Device Table Base Address Register (0000h)
		1	Device Table Segment 1 Base Address Register (0100h)
		2	Device Table Segment 2 Base Address Register (0108h)
		3	Device Table Segment 3 Base Address Register (0110h)
011b	8	0	Device Table Base Address Register (0000h)
		1	Device Table Segment 1 Base Address Register (0100h)
		2	Device Table Segment 2 Base Address Register (0108h)
		3	Device Table Segment 3 Base Address Register (0110h)
		4	Device Table Segment 4 Base Address Register (0118h)
		5	Device Table Segment 5 Base Address Register (0120h)
		6	Device Table Segment 6 Base Address Register (0128h)
		7	Device Table Segment 7 Base Address Register (0130h)
100b–111b	<i>Reserved.</i>	—	—

The most-significant 1, 2, or 3 bits of the DeviceID selects the table segment to be used for a DTE lookup when the table is divided respectively into 2, 4, or 8 segments. When two segments are enabled, the most significant bit of the DeviceID (DeviceID[15]) selects the table segment and bits [14:0] provide the index into the table segment to find the correct DTE for the device. When four segments are enabled, DeviceID[15:14] selects the table segment and bits [13:0] provide the index into the table segment to find the DTE for the device. When eight segments are enabled, DeviceID[15:13] selects the table segment and bits [12:0] provide the index into the segment.

To provide full coverage of the DeviceID space, when two segments are enabled, each table segment must be 1 Mbytes in length; when four segments are enabled, each table segment must be 512 Kbytes; when eight segments are enabled, each table segment must be 256 Kbytes. If the DeviceID space is sparsely filled, segments can be sized smaller in increments of 4 Kbytes. However, it should be noted that the first entry in each table segment m will always correspond to $\text{DeviceID} = m(65536 / n)$; where n = number of table segments.

DevTblSegEn should not be programmed to a value greater than the value DevTblSegSup.

2.2.3 I/O Page Tables for Host Translations

The IOMMU uses a page table structure designed to support a full 64-bit DVA space while allowing faster translation in many common cases. The format of the IOMMU page tables is a generalization of AMD64 Architecture long mode page tables while maintaining compatibility with them.

The IOMMU page tables are a multi-level tree of 4-Kbyte tables indexed by groups of 9 virtual

address bits (determined by the level within the tree) to obtain 8-byte entries. Each page table entry is either a page directory entry pointing to a lower-level 4-Kbyte page table, or a page translation entry specifying a system physical page address. A page translation entry is a page table entry with the Next Level field set to 0h or 7h. A page directory entry is a page table entry with the Next Level field not equal to 0h or 7h. The maximum value of Next Level in a page directory entry is defined in **MMIO Offset 0030h**[HATS]; exceeding this limit causes an IO_PAGE_FAULT.

The first generalization in the IOMMU page tables compared to AMD64 processor page tables is that directory entries, in addition to specifying the address of the lower page table, also specify the level, or grouping of bits within the virtual address, that is used for the next page table lookup step. This allows the IOMMU to skip page translation steps in cases where the virtual address often contains long strings of 0 bits, such as software architectures that allocate virtual memory sparsely.

The second generalization in the IOMMU page tables is that page translation entries can specify the page size of the translation. The default page size of a translation can be overridden by setting the Next Level bits to 7h. When the Next Level bits are 7h, the size of the page is determined by the first zero bit in the page address, starting from bit 12 (illustrated in **Table 14**). The page size specified by this method must be larger than the default page size and smaller than the default page size for the next higher level.

The page addresses illustrated in **Table 14** are 64-bit values that have been zero-extended from the 52-bit values specified in the DTE and page tables.

Table 14: Example Page Size Encodings

Level	Address Bits																		Page Size	Default Page Size	
	63:52**, 51:32*	3	3	2	2	2	2	2	2	2	2	2	2	1	1	1	1	1			1
1	Page Address																		0	8 KB	4 Kbytes
1	Page Address																		0 1	16 KB	4 Kbytes
1	Page Address													0	1	1	1	1	1	1 MB	4 Kbytes
2	Page Address													0	1	1	1	1	1	4 MB	2 Mbytes
3	Page Address	0	1	1	1	1	1	1	1	1	1	1	1	1	1	1	1	1	1	4 GB	1 Gbytes
6	7_FFFFh	1	1	1	1	1	1	1	1	1	1	1	1	1	1	1	1	1	1	Entire cache	NA
6	F_FFFFh	1	1	1	1	1	1	1	1	1	1	1	1	1	1	1	1	1	1	Undef	Undef

* Address bits 51:32 can be used to encode page sizes greater than 4 Gbytes.
 ** Address bits 63:52 are zero-extended.

Software Note: The page tables are required to have one PTE for each default page size (see **Table 15**). When the Next Level bits are equal to 7h, some of the least significant bits of the virtual address indexing the PTE are used for indexing the enlarged physical page, therefore those bits are not unique for indexing the PTE and the PTE must be repeated accordingly. For example, if the physical page is 32 Kbytes, the 3 least significant bits of the Page Table Level 1 virtual address cannot be

used only for indexing within the page table and therefore the PTE must be repeated 8 times for each of the 64 unique PTEs given 4-Kbyte page tables. Another example for 4-Mbyte pages is illustrated in [Figure 12](#). The PTE in the Level-2 page table is replicated twice and bit 21 of the virtual address is used twice for indexing, first to index the Level-2 table of PTEs and again to index into the 4-Mbyte page for the data. The replicated Level-2 PTEs have identical contents and follow the example in [Table 14](#) for a page size of 4 Mbytes. For larger page sizes, the PTEs must be replicated an appropriate number of times so that more bits of the virtual address can be used for indexing.

Implementation Note: While IOMMU implementations are not strictly required to include translation caches, it is strongly recommended that they include at least a cache for translations of 4-Kbyte page table entries. IOMMU implementations can cache translations of larger pages by splitting them into multiple 4-Kbyte cache entries.

The page table pointer for each domain specifies the system physical address and level of the root page table for that domain. Translation of a DVA begins by comparing it to the root page table's level. If the address contains any nonzero bits in bit positions higher than the range selected by the root page table's level, translation terminates with an `IO_PAGE_FAULT`. Otherwise, the appropriate group of virtual address bits is used to fetch a page table entry from the root page table. If this entry is marked not present, translation terminates with an `IO_PAGE_FAULT`. Otherwise the entry may be a page directory entry pointing to a lower-level page table (in which case the translation process repeats starting at the new page table using the remaining virtual address bits), or it may be a page translation entry containing the final system physical address (in which case the translation process terminates and the remaining DVA bits are concatenated with the translation entry's physical address to obtain a translated address). If a translation skips levels and any of the skipped virtual address bits are nonzero, translation terminates with an `IO_PAGE_FAULT`.

Effective write permission is calculated using the IW bits in the DTE (see [Table 7](#)), the I/O PDEs, and the I/O PTE. Device accesses to translated addresses are first checked against these cumulative permissions before being allowed to proceed. IW and IR bits from skipped levels are treated as if they were 1s. For a discussion of guest and host permissions, see [Section 2.2.7 \[Guest and Nested Address Translation\]](#).

[Table 15](#) specifies the virtual address bit groups used for indexing at each level of the page tables, as well as the default page sizes associated with page translation entries fetched from page tables at each level. [Figure 8](#) and [Figure 9](#) illustrate the formats of page table entries. If a page table entry contains nonzero bits in any of the fields marked reserved, if the Next Level field is greater than or equal to the current page table entry table's level, or if a page translation entry's physical address is not aligned to a multiple of the appropriate page size for the current page table entry page table's level, translation terminates with an `IO_PAGE_FAULT`.

The layout of IOMMU page table entries has been chosen so that the IOMMU can use AMD64 long mode processor page tables, provided the Next Level fields (which occupy bit positions ignored by AMD64 processors) are properly initialized according to their level within the processor page tables. (AMD64 processors lack the IOMMU's level skipping facility.) All other page table entry fields used by the IOMMU are either ignored by AMD64 processors, or have the same meaning to both the processor and the IOMMU. For more details on sharing page tables see [Section 2.2.4 \[Sharing AMD64 Processor and IOMMU Page Tables—GPA-to-SPA\]](#).

The U bit in the page tables is an attribute bit passed to peripherals in ATS responses. See Table 12 for the behavior of the IOMMU for settings of the DTE[Cache] and PTE[U] fields.

IOMMU implementations must zero-fill all high-order physical address (SPA). The IOMMU fields are architected to produce a physical address of up to 52 bits, thus physical address bits [63:53] are always zero.

Table 15: Page Table Level Parameters

Page Table Level	Virtual address bits indexing table	Default Page size (bytes) for translation entries
6	63:57	NA
5	56:48	2 ⁴⁸
4	47:39	2 ³⁹
3	38:30	2 ³⁰
2	29:21	2 ²¹
1	20:12	4096

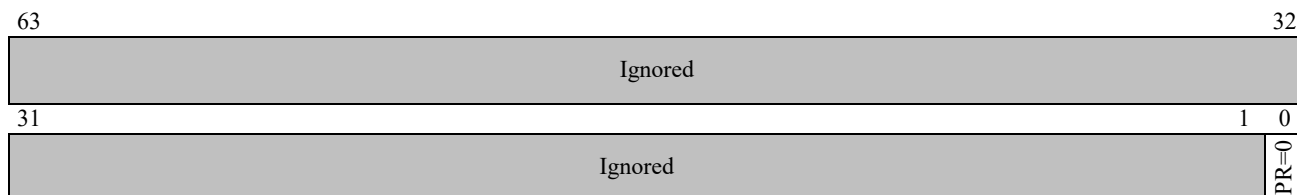

Figure 8: I/O Page Table Entry Not Present (any level)

Table 16: I/O Page Table Entry Not Present Fields, PR=0

Bits	Description
63:1	Ignored when PR=0.
0	PR: Present. 0=the remainder of the I/O page table entry is ignored and the corresponding memory page is considered not-present (see Section 2.5.3 [IO_PAGE_FAULT Event]). When PR=1, see Table 17 and Table 18.

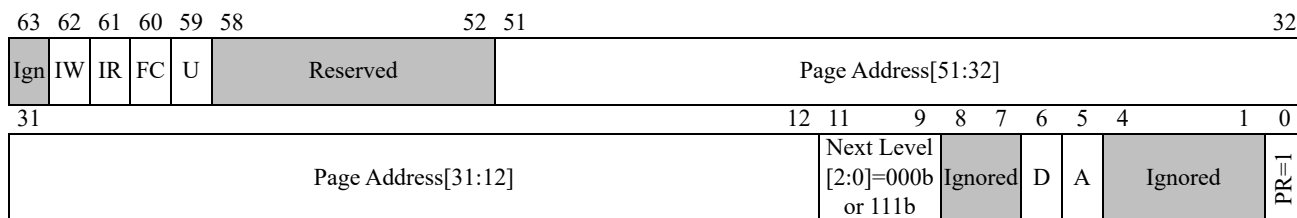

Figure 9: I/O Page Translation Entry (PTE), PR=1

Table 17: I/O Page Translation Entry (PTE) Fields, PR=1

Bits	Description
63	Ignored.
62	IW: write permission. 1=write operations are allowed. 0=write operations are not allowed (see Section 2.5.3 [IO_PAGE_FAULT Event]). Effective write permission is calculated using the IW bits in the DTE (see Table 7), the I/O PDEs, and the I/O PTE. At each step of the translation process, I/O write permission (IW) bits from fetched page table entries are logically ANDed into cumulative I/O write permissions for the translation including the IW bit in the DTE. IW bits from skipped levels are treated as if they were 1s. For a discussion of guest and host permissions, see Section 2.2.7 [Guest and Nested Address Translation] .
61	IR: read permission. 1=read operations are allowed. 0=read operations are not allowed (see Section 2.5.3 [IO_PAGE_FAULT Event]). Effective read permission is calculated using the IR bits in the DTE (see Table 7), the I/O PDEs, and the I/O PTE. At each step of the translation process, I/O read permission (IR) bits from fetched page table entries are logically ANDed into cumulative I/O read permissions for the translation including the IR bit in the DTE. IR bits from skipped levels are treated as if they were 1s. For a discussion of guest and host permissions, see Section 2.2.7 [Guest and Nested Address Translation] .
60	FC: Force Coherent. Software uses the FC bit in the PTE to indicate the source of the upstream coherent attribute state for an untranslated DMA transaction. 1 = the IOMMU sets the coherent attribute state in the upstream request. 0 = the IOMMU passes on the coherent attribute state from the originating request. Device internal address/page table translations are considered "untranslated accesses" by IOMMU. The FC state is returned in the ATS response to the device endpoint via the state of the (N)oSnoop bit.
59	U. The U bit in the I/O page table entry is an attribute bit passed to a peripheral in an ATS response for a GPA-to-SPA translation. For a GVA-to-SPA translation, hardware must set U=0 in the ATS response. For details, see Table 12 and the <i>PCI ATS Specification Version 1.1</i> or newer.
58:52	Reserved.
51:12	Page Address[51:12]: Specifies the SPA of the page.
11:9	NextLevel: next page translation level. Specifies the level of page translation as described in this section. For a PTE, the value of NextLevel must be 0h or 7h.
8:7	Ignored.
6	D: Dirty. This bit indicates whether the physical page to which this entry points has been written. The D bit is set to 1 by the IOMMU the first time there is a write to the physical page. The D bit is never cleared by the IOMMU. Instead, software must clear this bit to 0 as necessary. IOMMU only sets the D bit if MMIO Offset 0030h[HDSup]=1 and DTE[HAD]=11b .

Table 18: I/O Page Directory Entry (PDE) Fields, PR=1

Bits	Description
63	Ignored.
62	IW: write permission. 1=write operations are allowed. 0=write operations are not allowed (see Section 2.5.3 [IO_PAGE_FAULT Event]). Effective write permission is calculated using the IW bits in the DTE (see Table 7), the I/O PDEs, and the I/O PTE. Effective write permission is calculated using the IW bits in the DTE (see Table 7), the I/O PDEs, and the I/O PTE. At each step of the translation process, I/O write permission (IW) bits from fetched page table entries are logically ANDed into cumulative I/O write permissions for the translation including the IW bit in the DTE. IW bits from skipped levels are treated as if they were 1s. For a discussion of guest and host permissions, see Section 2.2.7 [Guest and Nested Address Translation] .
61	IR: read permission. 1=read operations are allowed. 0=read operations are not allowed (see Section 2.5.3 [IO_PAGE_FAULT Event]). Effective read permission is calculated using the IR bits in the DTE (see Table 7), the I/O PDEs, and the I/O PTE. At each step of the translation process, I/O read permission (IR) bits from fetched page table entries are logically ANDed into cumulative I/O read permissions for the translation including the IR bit in the DTE. IR bits from skipped levels are treated as if they were 1s. For a discussion of guest and host permissions, see Section 2.2.7 [Guest and Nested Address Translation] .
60:52	Reserved.
51:12	Next Table Address[51:12]/Page Address[51:12]: Specifies the SPA of the next page descriptor entry when NextLevel != 000b or 111b; specifies the SPA of the page when NextLevel = 000b or 111b. See discussion in this section.
11:9	NextLevel: next page translation level. Specifies the level of page translation as described in this section. The value of NextLevel cannot exceed the value of the Mode field in the DTE (Table 7).
8:6	Ignored.
5	A: Accessed. This bit indicates whether the physical memory to which this directory points has been accessed. The A bit is set to 1 by the IOMMU the first time the directory is either read from or written to. The A bit is never cleared by the IOMMU. Instead, software must clear this bit to 0 when it needs to track the frequency of physical-page accesses. IOMMU only sets the A bit if MMIO Offset 0030h[HDSup]=1 and DTE[HAD]=01b or 11b.
4:1	Ignored
0	PR: Present. 1=the remainder of the I/O PTE contains valid information. 0=see Table 16 .

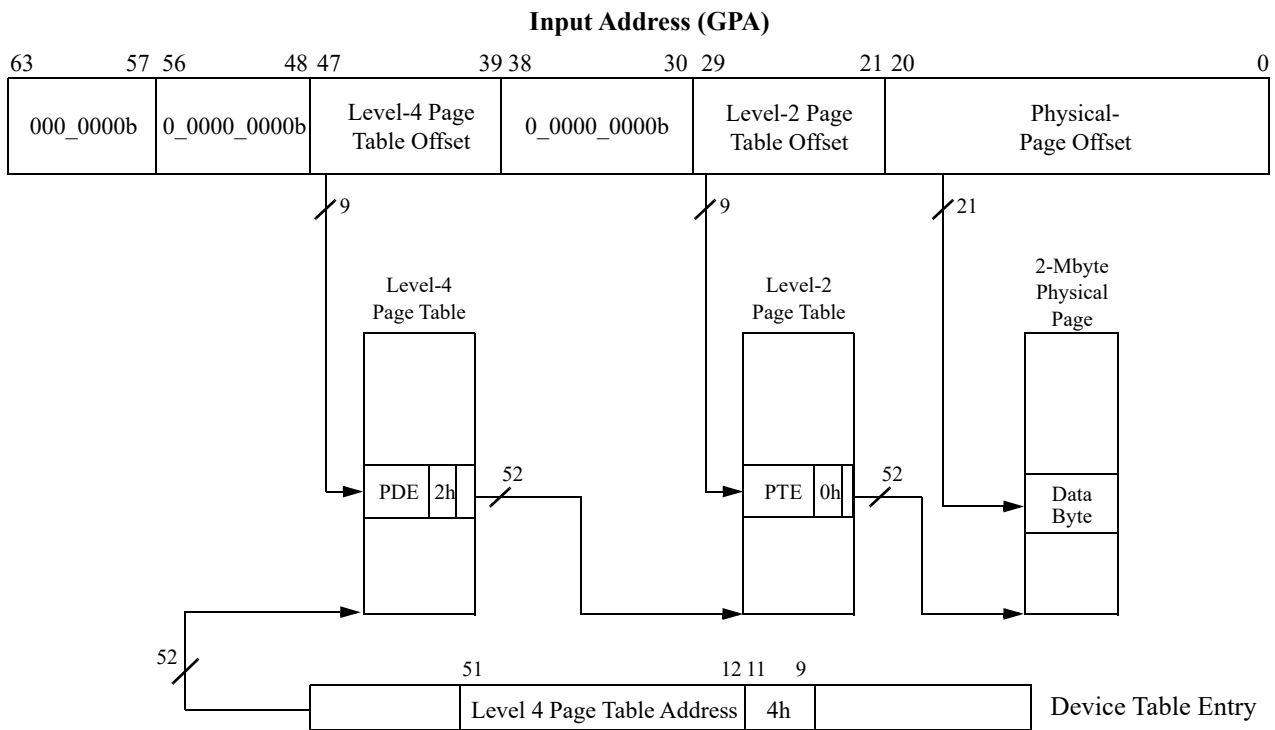

Figure 11: Address Translation Example with Skipped Level and 2-Mbyte Page

The input address in Figure 11 is a GPA that is supplied by the peripheral or translated from a GVA.

Using the nested page tables, the IOMMU translates the input GPA to an SPA within a 2-Mbyte physical page. The input address is mapped into page table offsets for the levels of address translation. The level-4 page table offset is used to index into the level-4 page table. The level-3 table offset is zero, so the contents of the level-4 page table entry points directly to a level-2 page table. The level-2 page table contains an entry with the next level=0, so that entry points directly to a 2-Mbyte page and the physical page offset is the 21 low-order bits of the input address.

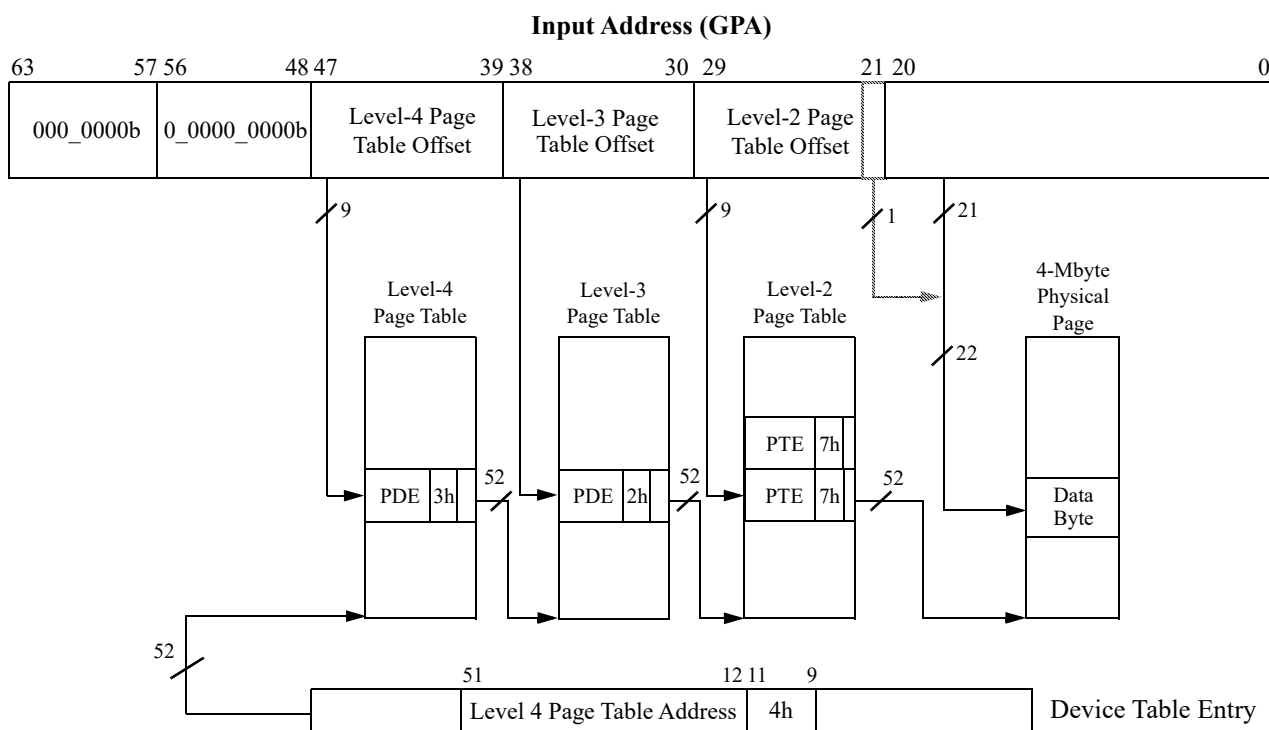

Figure 12: Address Translation Example with Page Size Larger than Default Size

The top address in Figure 12 is a GPA that is supplied by the peripheral or translated from a GVA.

Using the nested page tables, the IOMMU translates the input GPA to an SPA within a 4-Mbyte physical page. The translations for level-4 and level-3 are conventional and the next level fields are used to indicate contiguous levels of translation with no level skipping. The level-2 table contains paired entries with the next level fields set to 7h; as a result, bit 21 of the input GPA can be treated as an additional offset bit within a larger physical page 4 Mbytes in size. The adjacent PTE values in the level-2 page table must be adjacent 2-Mbyte page base addresses and the lower base address value must be set so that the page is 4-Mbyte aligned.

2.2.3.1 Host Access Support

The IOMMU supports setting Access bits in the host page table if `MMIO Offset 0030h[HASup]=1`. This feature is enabled using `DTE[HAD]`. When enabled, IOMMU hardware sets the Access bits in the host page table using atomic operations similar to the process described in Section 2.2.7.4 [Updating Accessed and Dirty Bits in the Guest Address Tables] on page 113. Similarly, software is responsible for clearing the Access bits in the host page table using the process described in Section 2.2.7.5 [Clearing Accessed and Dirty Bits] on page 114.

When a non-default page size is used, software must OR the Access bits in all of the replicated host PTEs used to map the page. The IOMMU does not guarantee the Access bits are set in all of the replicated PTEs. Any portion of the page may have been accessed even if the Access bit is set in only one

of the replicated PTEs.

Hypervisor software may use the host access bits to help decide whether a piece of guest memory should be paged out. Such software must also ensure that the guest memory is safe to page out. The mechanisms for doing so are outside the scope of the IOMMU specification.

2.2.3.2 Host Dirty Support

The IOMMU supports setting the Dirty bit in the lowest level of the host page table if [MMIO Offset 0030h\[HDSup\]=1](#). This feature is enabled using [DTE\[HAD\]](#). When enabled, IOMMU hardware sets the Dirty bit in the host page table using an atomic operation similar to the process described in [Section 2.2.7.4 \[Updating Accessed and Dirty Bits in the Guest Address Tables\]](#) on page 113. Similarly, software is responsible for clearing the Dirty bit in the host page table using the process described in [Section 2.2.7.5 \[Clearing Accessed and Dirty Bits\]](#) on page 114.

When a non-default page size is used, software must OR the Dirty bits in all of the replicated host PTEs used to map the page. The IOMMU does not guarantee the Dirty bits are set in all of the replicated PTEs. Any portion of the page may have been written even if the Dirty bit is set in only one of the replicated PTEs.

Hypervisor software may use the host dirty bit to optimize the page out of guest memory by avoiding redundant writes to the pagefile.

2.2.4 Sharing AMD64 Processor and IOMMU Page Tables—GPA-to-SPA

This section outlines the topics to be considered so that the host or GPA-to-SPA page tables may be shared with an IOMMU in an AMD64 system. A more complete discussion depends on many implementation factors.

AMD64 processors and the IOMMU treat upper virtual address bits [63:48] differently. The processor requires canonical addresses (in which address bits [63:48] are equal to bit 47). By contrast, the IOMMU is designed to support the full PCI 64-bit address space. If 6-level page tables are used, the IOMMU can map any 64-bit address. If fewer than 6 levels are used, the IOMMU requires upper virtual address bits (beyond the range mapped by the page tables) to be 0. This ensures that software can always add levels to page tables without changing the address space as seen by devices.

In AMD64 long mode level 4 page tables, the bottom 256 entries of the root page table correspond to positive virtual addresses with bits [63:47] all 0s and the top 256 entries correspond to negative virtual addresses with bits [63:47] all 1s.

For the IOMMU to directly share processor page tables, at a minimum the Next Level fields in all page table entries must be initialized with correct values for the IOMMU.

Once the Next Level fields are initialized, the IOMMU may directly share exactly the same page tables. In

3-level 32-bit PAE mode this is all that's needed. However, in 4-level long mode software should be aware that processor virtual addresses in the range `FFFF_8000_0000_0000h` to `FFFF_FFFF_FFFF_FFFFh` correspond to I/O virtual addresses in the range `0000_8000_0000_0000h` to `0000_FFFF_FFFF_FFFFh`.

If software requires 64-bit processor virtual addresses to be identical to I/O virtual addresses, includ-

ing negative addresses, software needs to configure the IOMMU with the 6-level paging structure illustrated in Figure 13, where 4 extra 4-Kbyte page tables (shaded) at levels 6, 5, and 4 are used solely by the IOMMU, and sharing with processor page tables occurs only at levels 3 and below.

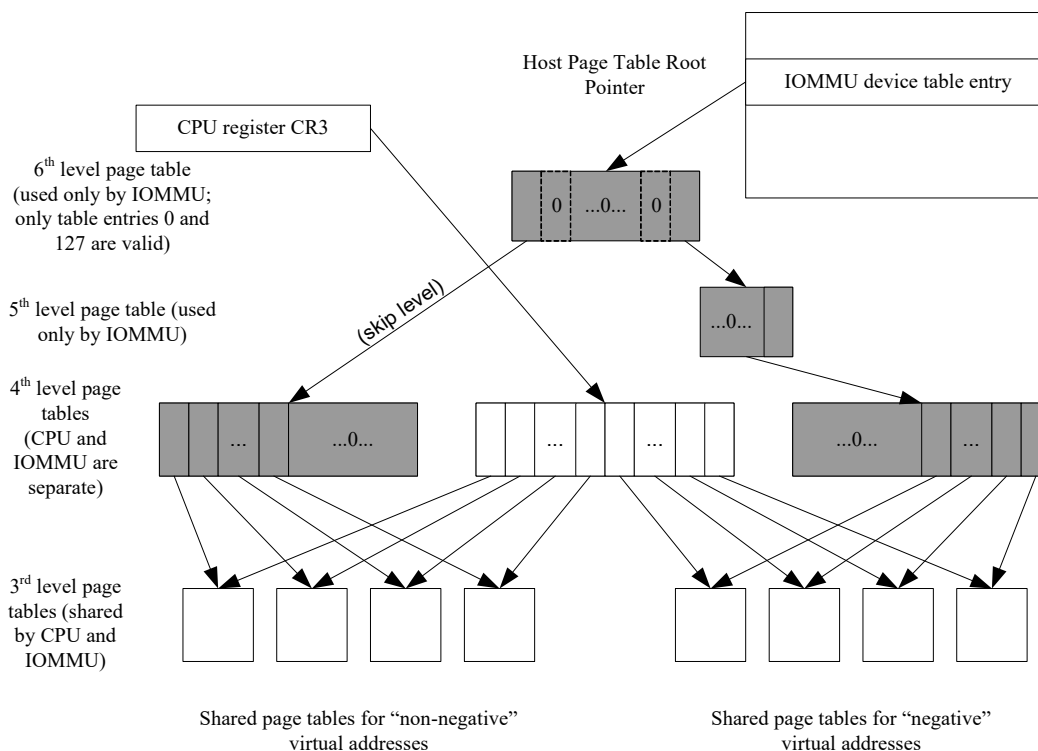

Figure 13: Sharing AMD64 and IOMMU Host Page Tables with Identical Addressing

2.2.5 Interrupt Remapping Tables

Interrupt messages use a system-reserved address range shown in Table 3. Legacy "fixed" and "arbitrated" Message Signaled Interrupts (MSI) are mapped through that address space where they can be remapped by the IOMMU. Startup Int, SMI, LINT0, LINT1, NMI, INIT, and External (ExtInt) interrupts are controlled individually, using the Device Table Entry (DTE) control fields. (See Table 10 and Table 19). The encoding is identical to the MT field definition (e.g., in HyperTransport)

When interrupt remapping and interrupt virtualization are active (Section 2.2.8 [Guest Virtual APIC Table for Interrupt Virtualization]), interrupts are remapped using the remapping tables and then posted for delivery to a guest OS. When the SMI filter is active (see Section 1.3.10 [SMI Filter]), upstream SMI requests are controlled through the SMI filter.

Table 19: IOMMU Controls and Actions for Upstream Interrupts

Interrupt type (with MT encoding)		Destination Mode (DM)	Controlled by
0000b	Fixed	0b	DTE and IRTE (Table 7 and Table 20)
0001b	Arbitrated		
0010b	SMI		MMIO Offset 0018h[SmiFLogEn]
0011b	NMI		DTE[NMIPass] (Table 7)
0100b	INIT		DTE[InitPass] (Table 7)
0110b	ExtInt		DTE[EIntPass] (Table 7)
1011b	Lint1		DTE[Lint1Pass] (Table 7)
1110b	Lint0		DTE[Lint0Pass] (Table 7)
0101b, 0111b, 1000b, 1001b, 1010b, 1100b, 1101b, 1111b	Startup, EOI, EOI		
0000b-0001b		1b	DTE and IRTE (Table 7 and Table 20)
0000b-1111b		1b	Target Abort

The IOMMU remaps HyperTransport™ addresses for fixed and arbitrated interrupts as shown in the concatenation in Figure 14 on page 89. The offset created by this concatenation corresponds directly to data bits 10:0 in the originating MSI interrupt message. After reading the interrupt remapping table entry, the IOMMU creates a new interrupt message address by OR'ing IRTE[23:2] with bits [63:2] of HyperTransport™ interrupt address range base (FD_F800_0000h). Interrupt table walks are always coherent.

Note: In previous versions of the IOMMU specification, interrupt types 0010b to 1111b with DM=1 were defined to support interrupt remapping instead of resulting in a target abort. No systems are known to rely on the older remapping behavior.

2.2.5.1 Interrupt Remapping Tables, Guest Virtual APIC Not Enabled

The IOMMU remaps fixed and arbitrated interrupts as shown in Figure 14. The IOMMU uses the information from the interrupt remapping table entry shown in Figure 15 and Table 20.

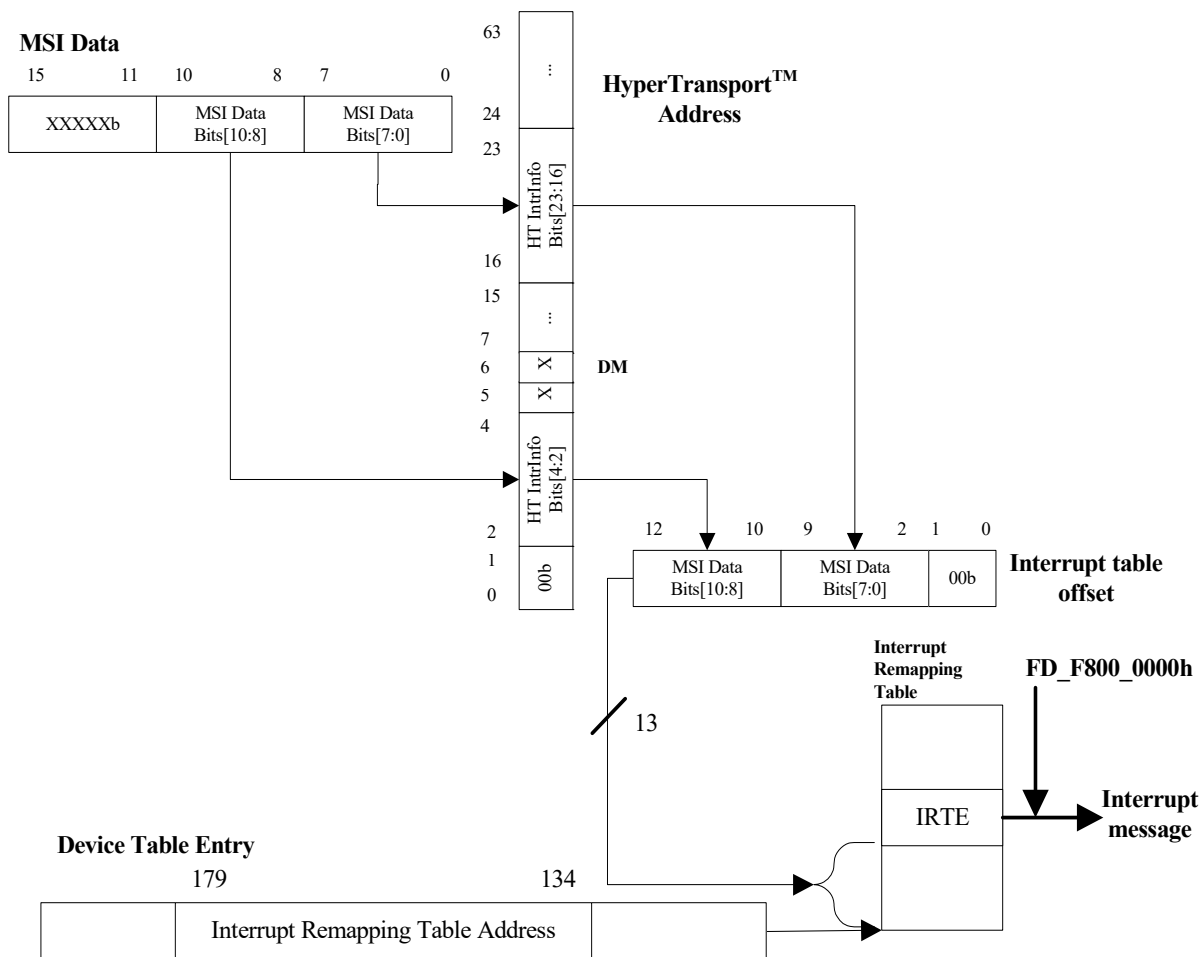

Figure 14: Interrupt Remapping Table Lookup for Fixed and Arbitrated Interrupts

To handle fixed and arbitrated interrupts with interrupt remapping, software programs the IRTE as shown in Figure 15 and Table 20.

31	24	23	16	15	8	7	6	5	4	2	1	0
Reserved				Vector	Destination		GuestMode	DM	RqEoi	IntType	SupIOPF	RemapEn

Figure 15: Interrupt Remapping Table Entry - Basic Format

Table 20: Interrupt Remapping Table Fields - Basic Format

Bits	Description
31:24	Reserved.
23:16	Vector. Specifies the interrupt vector for the interrupt.
15:8	Destination. Specifies the APIC logical or physical address to send the interrupt to.

Table 20: Interrupt Remapping Table Fields - Basic Format (Continued)

Bits	Description
7	GuestMode. Must be zero for IRTE in the format defined by Figure 15 and this table. See also Figure 18 and Table 23
6	DM: destination mode. 1=Logical destination mode. 0=Physical destination mode.
5	RqEoi: request EOI. 1=EOI cycle required. <i>Software Note: If RqEoi=1, software is responsible for performing the reverse mapping of the vector number.</i>
4:2	IntType: interrupt type. This field specifies the type of interrupt message to deliver to the Local APIC. 000b = Fixed. 001b = Arbitrated. 010b – 111b = Reserved.
1	SupIOPF: suppress IO_PAGE_FAULT events. 1=Suppress logging when use of this remapping entry causes an IO_PAGE_FAULT. 0=Log event when this entry causes an IO_PAGE_FAULT. See the IG control bit in the Device Table entry (Section 2.2.2.1 [Device Table Entry Format]). <i>Note: SmiFLogEn independently controls the creation of IO_PAGE_FAULT log entries generated by the SMI filter (see Section 1.3.10 [SMI Filter]).</i>
0	RemapEn. 1=Interrupt is remapped. 0=Interrupt is target aborted. <i>Note: SupIOPF is meaningful independent of the value of RemapEn.</i>

2.2.5.2 Interrupt Virtualization Tables with Guest Virtual APIC Enabled

Legacy interrupts are processed using the SMI filter (see [Section 2.1.5 \[System Management Interrupt \(SMI\) Controls\]](#)) and control fields in the DTE (see [Section 2.2.2.1 \[Device Table Entry Format\]](#)).

In the base functionality, interrupt virtualization using the guest virtual APIC is not supported; for interrupt remapping of fixed and arbitrated interrupts, see [Section 2.2.5.1 \[Interrupt Remapping Tables, Guest Virtual APIC Not Enabled\]](#). The IRTE format defined in [Table 20](#) and [Figure 15](#) is supported. The IRTE formats defined by [Table 22](#), [Table 23](#), [Figure 17](#) and [Figure 18](#) are not supported.

Optional features provide support for the virtualization of device interrupts using the guest virtual APIC (see [MMIO Offset 0030h\[GASup\]](#) and [MMIO Offset 0030h\[GAMSup\]](#)). Virtual interrupts are enabled when programmed by [MMIO Offset 0018h\[GAEn\]](#) and [MMIO Offset 0018h\[GAMEn\]](#), see [Table 21](#). When virtual interrupts are enabled, the IOMMU uses IRTE entries listed in [Table 21](#) for fixed and arbitrated interrupts. The IRTE formats defined by [Table 20](#), [Table 22](#), [Table 23](#), [Figure 15](#), [Figure 17](#) and [Figure 18](#) are supported and selected as shown in [Table 21](#). When IRTE[Guest-Mode]=0, the IOMMU uses [Table 22](#) and [Figure 17](#) for interrupt remapping. When IRTE[Guest-Mode]=1, the IOMMU uses [Table 23](#) and [Figure 18](#) for interrupt virtualization using the guest virtual APIC. Software must program all IOMMUs in a system to use the same size of IRTE (in [Table 21](#), all IOMMUs must be programmed with the same values of [MMIO Offset 0018h\[GAEn\]](#) and [MMIO Offset 0018h\[GAMEn\]](#)).

Table 21: Interrupt Virtualization Controls for Upstream Interrupts

MMIO Offset 0030h		MMIO Offset 0018h		IRTE Size (bits)	IOMMU Interrupt Transformation
GASup	GAMSup	GAEn	GAMEn		
0	XXXb	Xb	XXXb	32	Interrupt remapping (see Table 20 and Figure 15).
1	XXXb	0	XXXb		
1	000b	1	XXXb	128	Interrupt remapping (see Table 22 and Figure 17)
1	001b	1	001b		Virtualized interrupts using the guest virtual APIC (see Table 23 and Figure 18),
1	010b-111b	1	010b-111b	N/A	Reserved.

When guest APIC virtualization is supported, the IOMMU processes upstream fixed and arbitrated interrupts as follows:

1. The IOMMU receives the upstream interrupt request.
2. The IOMMU checks the values of [MMIO Offset 0030h\[GASup\]](#), [MMIO Offset 0030h\[GAMSup\]](#), [MMIO Offset 0018h\[GAEn\]](#), and [MMIO Offset 0018h\[GAMEn\]](#).
3. The IOMMU selects the 32-bit or 128-bit IRTE formats and the corresponding table stride based on the register settings as shown in [Table 21](#).
4. If programmed for 32-bit mode, the IOMMU handles the interrupt as defined in [Section 2.2.5.1 \[Interrupt Remapping Tables, Guest Virtual APIC Not Enabled\]](#).
5. The IOMMU uses the DeviceID of the upstream interrupt to select the appropriate DTE (see [Section 2.2.2.1 \[Device Table Entry Format\]](#)).
6. The IOMMU uses the Interrupt Table Root Pointer in the DTE and the incoming interrupt vector to select an IRTE.
7. If $IRTE[RemapEn]=0$, then the interrupt is reported as an `IO_PAGE_FAULT` event (see [Table 44](#) and [Section 2.5.3](#)).
8. If $IRTE[GuestMode]=0$, then use the IRTE format shown in [Figure 17](#) and [Table 22](#) to remap the upstream interrupt using the IRTE information in the same manner as described in [Section 2.2.5.1 \[Interrupt Remapping Tables, Guest Virtual APIC Not Enabled\]](#) while using the IRTE format in [Figure 17](#) and [Table 22](#).
9. If $IRTE[GuestMode]=1$, then treat the upstream interrupt as a guest virtual interrupt and the supplied destination and vector information are used as follows using the IRTE format in [Figure 18](#) and [Table 23](#).
 - Determine the bit index by calculating $IRTE[Vector] \bmod 32$ (see [Figure 16](#)).
 - Determine the byte offset by calculating $(IRTE[Vector] / 32) \ll 4$.
 - Calculate the target byte of the virtual IRR in the guest virtual APIC backing page by adding: $IRTE[GuestVirtualAPICTableRootPointer] + 0200h +$ the calculated byte offset.
 - Atomically set one bit using the calculated bit index within the calculated target byte.

- Read the IRTE from memory.
- If IRTE[IsRun]=0b and IRTE[GALogIntr]=1b, then the IOMMU creates a guest virtual APIC log entry using IRTE[GATag] (see Section 2.7 [Guest Virtual APIC (GA) Logging]) and signals an interrupt.
- If IRTE[IsRun]=1b, then the IOMMU sends a guest APIC doorbell signal using the Destination field in Table 23.

Hardware Note: The bit index and byte offset calculations are described using an 8-bit byte for a 1-byte memory operation. The calculation method may be converted to a multi-byte-wide operation that does not exceed 256 bits and the atomic-OR operation may use any byte width that is a power of 2 between 1 and 32 bytes, inclusive, by scaling the divisor. Using an 8-bit example, the bits of the virtual IRR in the virtual APIC backing page are numbered as in Figure 16 (where n is calculated as IRTE[Vector] modulo 8):

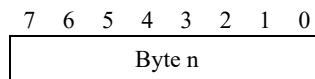

Figure 16: Bit Numbering of Virtual IRR in the Virtual APIC Backing Page

To handle an interrupt for remapping when the guest APIC is enabled, software programs the IRTE as shown in Figure 17 and Table 22 with GuestMode=0.

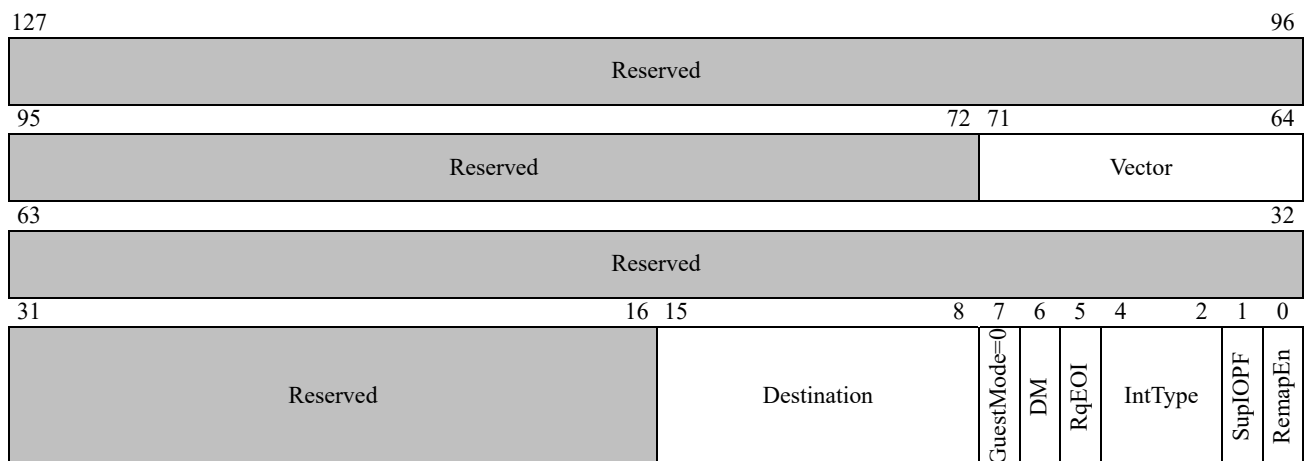

Figure 17: IRTE Fields with Guest Virtual APIC, IRTE[GuestMode]=0

Table 22: IRTE Field Descriptions with Guest Virtual APIC, IRTE[GuestMode]=0

Bits	Description
127:72	Reserved when RemapEn=1. Ignored when RemapEn=0.
71:64	Vector. Specifies the interrupt vector for the upstream interrupt.
63:16	Reserved when RemapEn=1. Ignored when RemapEn=0.
15:8	Destination. Specifies the APIC logical or physical address to which to send the interrupt.

Table 22: IRTE Field Descriptions with Guest Virtual APIC, IRTE[GuestMode]=0

Bits	Description																
7	GuestMode. Must be zero for IRTE in the format defined by Figure 17 and this table. See also Figure 18 and Table 23																
6	DM: destination mode. 1=Logical destination mode. 0=Physical destination mode.																
5	RqEoi: request EOI. 1=EOI cycle required. <i>Software Note: If RqEoi=1, software is responsible for performing the reverse mapping of the vector number.</i>																
4:2	IntType: interrupt type. This field specifies the type of interrupt message to deliver to the Local APIC. <table border="0" style="margin-left: 20px;"> <tr> <td>000b</td> <td>Fixed</td> <td>001b</td> <td>Arbitrated</td> </tr> <tr> <td>010b</td> <td>Reserved</td> <td>011b</td> <td>Reserved</td> </tr> <tr> <td>100b</td> <td>Reserved</td> <td>101b</td> <td>Reserved</td> </tr> <tr> <td>110b</td> <td>Reserved</td> <td>111b</td> <td>Reserved</td> </tr> </table>	000b	Fixed	001b	Arbitrated	010b	Reserved	011b	Reserved	100b	Reserved	101b	Reserved	110b	Reserved	111b	Reserved
000b	Fixed	001b	Arbitrated														
010b	Reserved	011b	Reserved														
100b	Reserved	101b	Reserved														
110b	Reserved	111b	Reserved														
1	SupIOPF: suppress IO_PAGE_FAULT events. 1=Suppress logging when use of this remapping entry causes an IO_PAGE_FAULT. 0=Log event when this entry causes an IO_PAGE_FAULT. See the IG control bit in the Device Table entry (Section 2.2.2.1 [Device Table Entry Format]). <i>Note: SmiFLogEn independently controls the creation of IO_PAGE_FAULT log entries generated by the SMI filter (see Section 1.3.10 [SMI Filter]).</i>																
0	RemapEn. 1=Interrupt is remapped. 0=Interrupt is target aborted. <i>Note: SupIOPF is meaningful independent of the value of RemapEn.</i>																

To handle an interrupt using the guest APIC, software programs the IRTE as shown in Figure 18 and Table 23 with GuestMode=1.

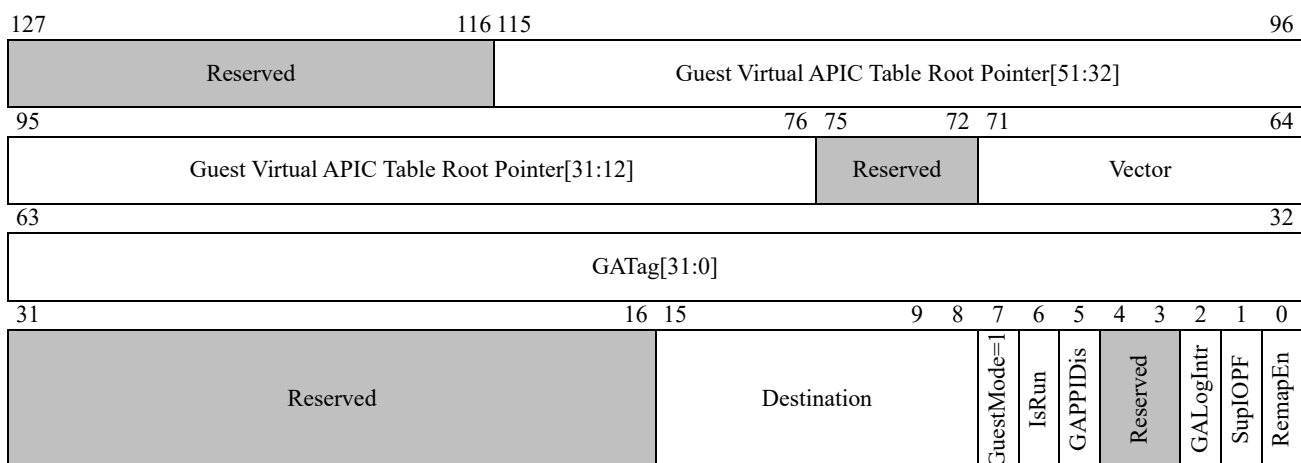

Figure 18: IRTE Fields with Guest Virtual APIC, IRTE[GuestMode]=1

Table 23: IRTE Field Descriptions with Guest Virtual APIC, IRTE[GuestMode]=1

Bits	Description
127:116	Reserved when RemapEn=1. Ignored when RemapEn=0.
115:76	Guest Virtual APIC Table Root Pointer. Specifies the system physical address of the APIC backing page when RemapEn=1.
75:72	Reserved when RemapEn=1. Ignored when RemapEn=0.
71:64	Vector[8:0]. Used to calculate the address within the guest virtual APIC backing page.
63:32	GATag: The GATag field is used when the IOMMU writes to the guest virtual APIC log (see Section 2.7 [Guest Virtual APIC (GA) Logging]).
31:16	Reserved.
15:8	Destination[8:0]. Destination core for the Guest Virtual APIC doorbell message.
7	GuestMode. Must be 1 for an IRTE in the format defined by Figure 18 and this table to indicate this IRTE contains guest virtual APIC information. When GuestMode=0, see Figure 15 and Table 20 .
6	IsRun: is-running hint. 0b=the guest is not running and the interrupt information will be logged to the guest APIC memory page and the guest APIC log (see Section 2.7 [Guest Virtual APIC (GA) Logging]). 1b=the guest is running and can accept the virtualized interrupt.
5	GAPPIDis: 1 = IOMMU suppresses GAPPI Interrupt notifications but continues to log guest interrupts in the IRR. 0 = IOMMU generates GAPPI interrupt if all the guest IRR bits were previously clear prior to the last IRR update. The bit is only applicable when GuestMode=1 and MMIO Offset 0018h[GAPPIEn]=1 . The bit is Reserved when MMIO Offset 01A0h[GAPPIDisSup]=0
4:3	Reserved.
2	GALogIntr: 1=Write Guest virtual APIC log entry into GA Log buffer using IRTE[GATag] when IRTE[isRun]=0b. 0=Guest virtual APIC log entry is suppressed when IRTE[isRun]=0b.
1	SupIOPF. Not governed by RemapEn.
0	RemapEn: remap enable. This bit indicates the IRTE fields, except SupIOPF, are valid. 0=the IRTE contents are ignored by hardware except SupIOPF. When the IOMMU attempts to use the contents of this IRTE, it will generate an IO_PAGE_FAULT (see Section 2.5.3 [IO_PAGE_FAULT Event]). 1=the guest virtual APIC table root pointer, vector, GATag, destination, GuestMode, and IsRun fields are valid.

2.2.5.3 IOMMU x2APIC Support

The IOMMU supports the extensions of interrupt processor addressability when the system is in x2APIC mode. The support of this capability is indicated in MMIO 0x30 [XTSup]=1. In systems with x2APIC enabled, software must set MMIO 0x18[XTEn]=1 and MMIO 0x18[GAEEn]=1. This

enables the use of the 128-bit IRTE format with 32-bit destination field. Even if Guest Virtual APIC will not be used, software must set MMIO 0x18[GAEn]=1. In this case, software should set all IRTEs with IRTE[GuestMode]=0.

When MMIO 0x18[IntCapXTEn]=1, interrupts originating from the IOMMU itself are sent based on the programming in XT IOMMU Interrupt Control Registers in MMIO 0x170-0x180 instead of the programming in the IOMMU's MSI capability registers.

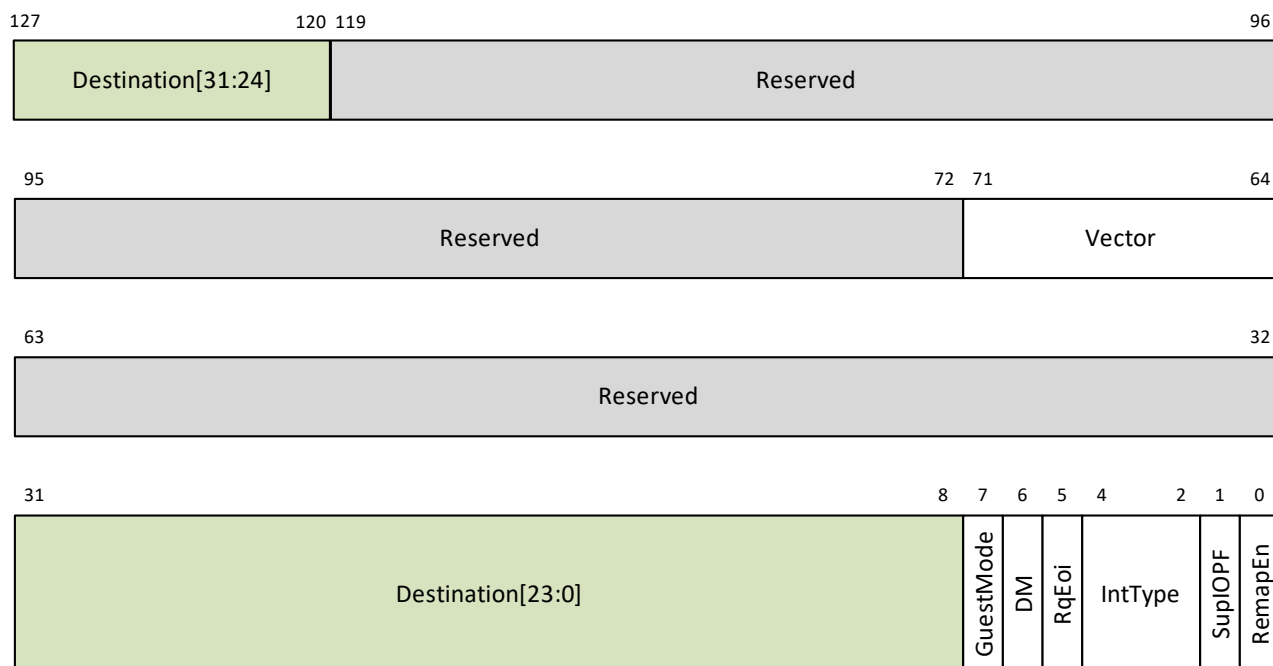

Figure 19: IRTE Fields with Guest Virtual APIC, IRTE[GuestMode]=0

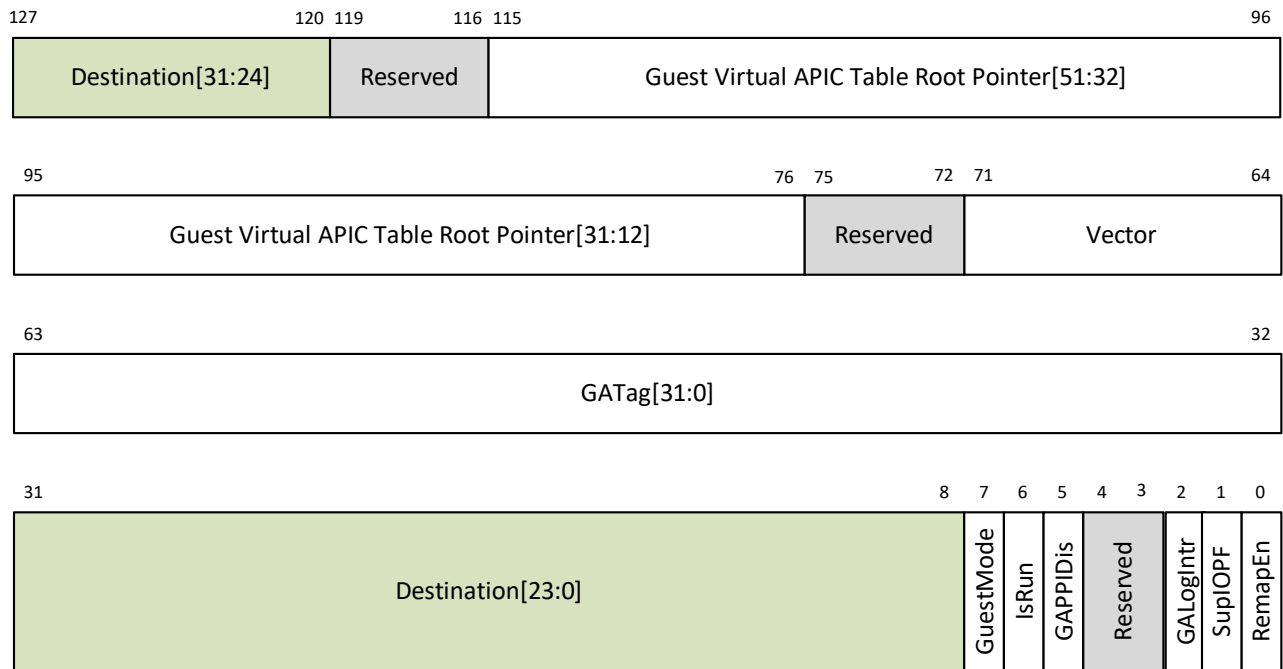

Figure 20: IRTE Fields with Guest Virtual APIC, IRTE[GuestMode]=1

Destination[31:8] are reserved and MSZ when MMIO 0x30[XTSup]=0 or MMIO 0x18[XTEn]=0.

2.2.5.4 Guest APIC Physical Processor Interrupt

When MMIO Offset 0030h[GAPPISup] = 1, the IOMMU supports an alternative mode for handling AVIC guest interrupts to non-running guests which avoids the use of the guest vAPIC virtual interrupt request log (GALog). This mode is enabled by setting MMIO Offset 0018h[GAPPIEn]=1. Under this mode, guest interrupts (IRTE[GuestMode]=1) update the vAPIC backing page IRR status as normal. Writing to the GALog is suppressed for non-running guests (IRTE[IsRun]=0) if IRTE[GALogIntr]=0. Instead, in GAPPI mode, a GAPPI interrupt is generated if all of the guest IRR bits were previously clear prior to the last IRR update. This indicates the new interrupt is the first pending interrupt to the vCPU. The GAPPI interrupt is used to signal Hypervisor software to schedule one or more vCPUs to execute pending interrupts. The GAPPI interrupt is issued with the following parameters:

Destination = IRTE[destination]

Vector = IRTE[GATag[7:0]]

Message Type = 0

Destination Mode = 0

RQEOI = 0

Implementations may not be able to perfectly determine if all of the IRR bits were previously clear prior to updating the vAPIC backing page to set IRR. Spurious interrupts may be generated as a result. Software must be designed to handle this possibility.

IOMMU optionally supports suppressing GAPPI Interrupt but still has the virtual interrupt logged in the IRR. Support for this feature is controlled through **MMIO Offset 01A0h**[GAPPIDisSup] and IRTE[GAPPIDis] fields when IRTE[GuestMode]=1. When **MMIO Offset 01A0h**[GAPPIDisSup]=1 and IRTE[GAPPIDis]=1, IOMMU suppresses the GAPPI Interrupt but still updates the vAPIC backing page IRR status as normal.

2.2.6 I/O Page Tables for Guest Translations

When **MMIO Offset 0030h**[GTSup] = 1, the IOMMU supports guest address translations.

The use of guest address translation is controlled by values in the DTE (GV and GLX), **MMIO Offset 0018h**[GTEn], and **MMIO Offset 0030h**[GLXSup]. Software can use guest address translation by programming hardware support as shown as in [Table 5](#). The size of the guest address is defined by **MMIO Offset 0030h**[GATS]; exceeding this limit generates an IO_PAGE_FAULT.

Table 24: Guest Address Translation Controls

MMIO Offset 0030h		MMIO Offset 0018h	Device Table Entry		Description
GTSup	GLXSup	GTEn	GV	GLX	(See also Table 11)
0	XXb	X	MBZ	MBZ	Guest translation is not supported by the IOMMU.
1	XXb	0	X	XX	Guest translation is not active for the IOMMU.
1	XXb	1	0	XX	Guest translation is not active for the DeviceID.
1	00b, 01b	1	1	00b	Guest translation is active. The GCR3 table is a one-level table in system physical memory.
1	01b	1	1	01b	Guest translation is active. The GCR3 table is a two-level table.

When guest address translation is active, the IOMMU will process a guest virtual addresses when it has a valid PASID (see [Section 2.2.7.7 \[PCIe® TLP PASID Prefix\]](#)).

2.2.6.1 Support for AMD64 Guest Page Table NX field

IOMMU optionally supports the enforcing of guest page no-execute protection. If the NX bit is set in a page table entry at any level of the page table in the guest page table walk, the page is designated as a non-executable page. Attempted access to a non-executable page by I/O devices with the EXE bit set in PCIe TLP PASID Prefix is blocked and an event is logged in the event log. Support for this feature is indicated by **MMIO Offset 0030h**[NXSup] = 1.

2.2.6.2 AMD64 Guest Page Table Access Protection

IOMMU optionally supports the blocking of attempted access by I/O devices to pages that are designated as requiring supervisor privilege. If the U/S bit is 0 in a page table entry at any level of the page table in the guest page table walk, the page is designated as requiring supervisor-level privilege.

Two levels of protection are provided: privilege checking and global privileged access abort. The level of protection is controlled by programming the PrivAbtEn field of the **IOMMU Control Register** [MMIO Offset 0018h]. If PrivAbtEn is programmed with the value 00b, any access by an I/O device with the PMR bit of the TLP PASID Prefix cleared (PMR = 0; User-level privilege) is blocked for a page that is designated as requiring supervisor-level privilege and an event is logged in the event log. If PrivAbtEn is programmed to the value 01b, any access by an I/O device to a page designated as requiring supervisor-level privilege is blocked regardless of the setting of the PMR bit and an event is logged in the event log.

Support for this feature is indicated by MMIO Offset 0030h[USSup] = 1.

2.2.6.3 Guest CR3 Table

When guest translation is active (see Table 24), the DTE contains an SPA or GPA pointer (depending on MMIO Offset 0018h[GCR3TRPMode]) to a GCR3 table containing GPA entries that are structured like processor CR3 values. The GCR3 table root pointer in the DTE is used when a transaction contains a valid PASID. When valid and present, the PASID is used to walk the guest CR3 table. When MMIO Offset 0030h[GLXSup]=00b, hardware supports a one-level lookup table so the table must be a 4-Kbyte page and must be naturally aligned. Figure 21 illustrates a lookup for guest translation tables.

Software Note: IOMMU TLBs are not cleared when a value is changed in the guest CR3 table and software must issue invalidation commands. (See Section 2.4 [Commands].)

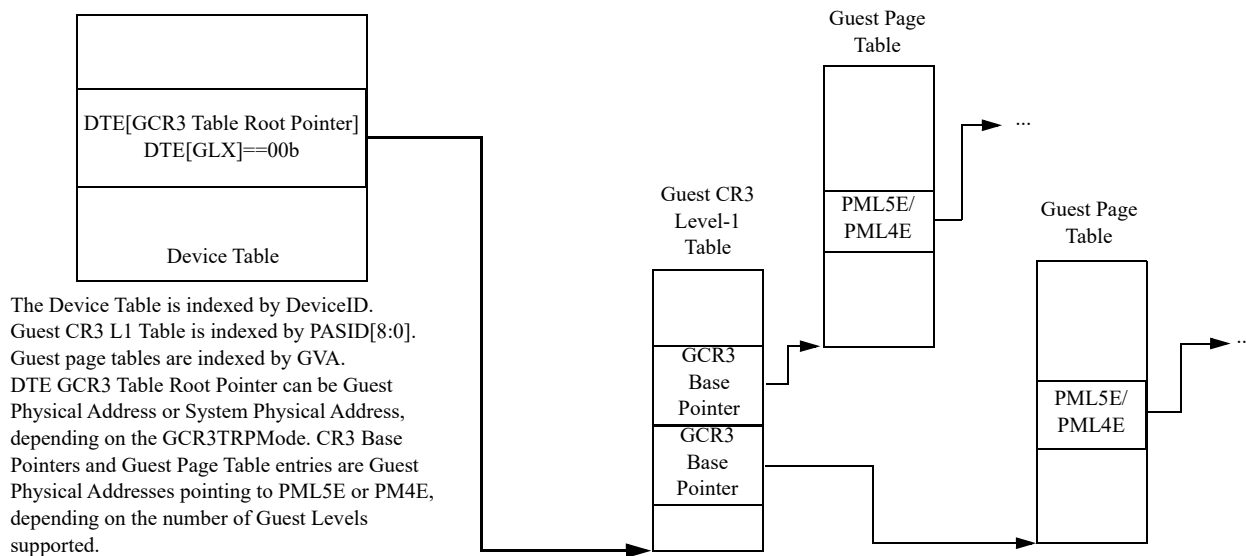

Figure 21: Guest CR3 Table, 1 Level

Figure 21 shows how a DTE links to a guest page table using a guest CR3 level 1 table. When guest translation is active (see Table 24) with DTE[GLX] = 00b and the peripheral supplies a valid PASID, the lower portion of the PASID field is used to index the guest CR3 level 1 table to select a CGR3 base pointer that is the root of a guest page table. The IOMMU ignores the upper PASID bits when DTE[GLX] = 00b.

IOMMU optionally supports supplying GPA based pointer to Guest CR3 Table inside DTE instead of SPA. Support for this feature is indicated through [MMIO Offset 01A0h\[GCR3TRPModeSup\]](#) and [MMIO Offset 0018h\[GCR3TRPMode\]](#). When [MMIO Offset 01A0h\[GCR3TRPModeSup\]](#)=1 and [MMIO Offset 0018h\[GCR3TRPMode\]](#)=1, the GCR3 table root pointer inside the DTE contains a GPA pointing to the guest CR3 level 1 table. The GPA will be translated by the IOMMU using the nested page table referenced by DTE[Host Page Table Root Pointer]. (See [Section 2.2.3 \[I/O Page Tables for Host Translations\]](#).) When [MMIO Offset 01A0h\[GCR3TRPModeSup\]](#)=0 or if [MMIO Offset 0018h\[GCR3TRPMode\]](#)=0, the GCR3 table root pointer inside the DTE contains an SPA pointing to the guest CR3 level 1 table.

Each valid GCR3 base pointer in the guest CR3 level 1 table is the GPA of a guest page table. Guest page tables may be Level 4 or Level 5 page tables starting with a PML4 table or a PML5 table (see AMD64 processor architecture specification), respectively. The start level is controlled through [MMIO Offset 0030h\[GATS\]](#) and DTE[GuestPagingMode] fields. See Support for AMD64 Level 5 (PML5E) Page Table.

The IOMMU translates a GPA in the GCR3 level 1 table to a system physical address as needed. GCR3 base pointer in [Figure 21](#) is structured as valid bit with a 4-Kbyte aligned pointer to the guest page table using the formats specified in [Table 25](#) and [Figure 22](#).

Table 25: AMD64 Guest CR3 Level-1 Table Format

Byte Offset	Guest CR3 Base Table Contents
0	GCR3 Base Pointer entry for PASID ₀ (GPA)
8	GCR3 Base Pointer entry for PASID ₁ (GPA)
16	GCR3 Base Pointer entry for PASID ₂ (GPA)
...	...
4088	GCR3 Base Pointer entry for PASID ₅₁₁ (GPA)

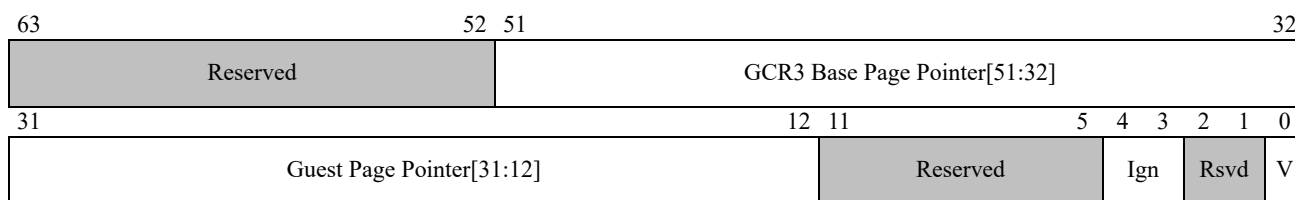

Figure 22: AMD64 GCR3 Base Pointer Entry Format

Table 26: AMD64 GCR3 Base Pointer Entry Fields

Bits	Description
63:52	Reserved when V=1. Ignored when V=0.
51:12	Guest Page Table Pointer. Specifies a GPA base table address when V=1.
11:5	Reserved when V=1. Ignored when V=0.

Table 26: AMD64 GCR3 Base Pointer Entry Fields (Continued)

Bits	Description
4:3	Ignored. The PCD and PWT bits used in the processor CR3 register are ignored by the IOMMU.
2:1	Reserved when V=1. Ignored when V=0.
0	V: Valid. Valid bit for the GCR3 base table pointer. 0=the GCR3 base pointer is ignored by hardware. 1=the GCR3 base pointer is the GPA of the root page of a guest page table.

The structure in Figure 21 on page 98 may be used when software programs DTE[GLX] = 00b. In this mode, PASID values up to 9 bits long are supported. When software programs DTE[GLX] = 01b, PASID values up to 18 bits long are supported. The two-level structure in Figure 23 will be used. Software may program DTE[GLX]=10b to enable a three-level structure used to support larger PASID widths up to 20 bits.

The Device Table is indexed by DeviceID.
 Guest CR3 Level-2 Table and GCR3 Level-1 Tables are indexed using PASID.
 Guest page tables are indexed by GVA.
 DTE GCR3 Table Root Pointer can be Guest Physical Address or System Physical Address, depending on the GCR3TRPMode.
 CR3 Base Pointers and Guest Page Table entries are Guest Physical Addresses pointing to PML5E or PM4E, depending on the number of Guest Levels supported

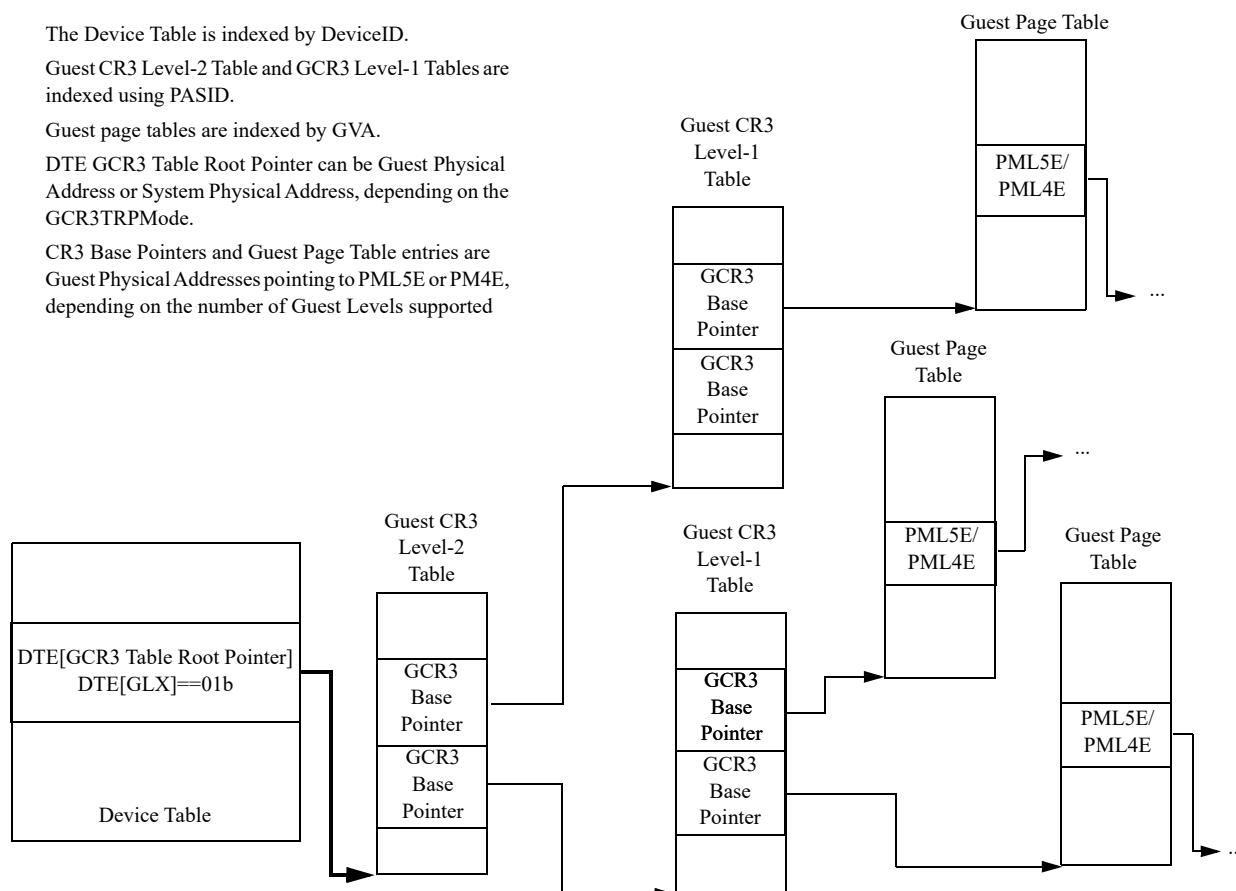

Figure 23: Guest CR3 Table, 2 Level

Figure 22 shows how a DTE links to a guest page table using a two-level guest CR3 table. When DTE[GLX]=01b and guest translation is active, the GCR3 table root pointer in the DTE is the SPA or

GPA (depending on MMIO Offset 0018h[GCR3TRPMode]) of a guest CR3 level-2 table; each valid GCR3 base table pointer in the guest CR3 level-2 table is the GPA of a guest CR3 level-1 table.

When a peripheral supplies an address with a valid PASID and DTE[GLX] = 01b, the IOMMU translates the GPA in the GCR3 level-2, GCR3 level-1, and guest page table to an SPA as needed. The guest CR3 level-2 table is indexed using PASID[17:9]. Upper PASID bits are ignored.

Each GCR3 level-2 base pointer diagram in Figure 24 is structured as valid bit with a 4-Kbyte aligned pointer to the guest page table using the formats specified in Table 27 and Figure 24. GCR3 level-1 tables use the format specified in Table 25 and Table 26 on page 99 and Figure 22 on page 99.

Table 27: Guest CR3 Level-2 Table Format

Byte Offset	Guest CR3 Level-2 Table Contents
0	GCR3 Base Table Pointer to GCR3 Level-1 Table ₀ (GPA)
8	GCR3 Base Table Pointer to GCR3 Level-1 Table ₁ (GPA)
16	GCR3 Base Table Pointer to GCR3 Level-1 Table ₂ (GPA)
...	...
4088	GCR3 Base Table Pointer to GCR3 Level-1 Table ₅₁₁ (GPA)

Each GCR3 base table pointer in Table 27 is structured as a valid bit with a 4-Kbyte aligned GPA of a GCR3 table level-1 table.

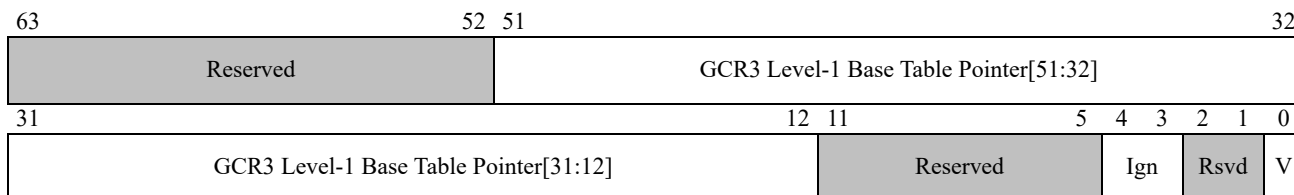

Figure 24: Guest CR3 Level-2 Base Table Pointer Format

Table 28: Guest CR3 Level-2 Base Table Pointer Fields

Bits	Description
63:52	Reserved when V=1. Ignored when V=0.
51:12	GCR3 Level-1 Base Table Address. Specifies a GPA base table address when V=1. Ignored when V=0.
11:5	Reserved when V=1. Ignored when V=0.
4:3	Ignored. The PCD and PWT bits used in the processor CR3 are ignored by the IOMMU.
2:1	Reserved when V=1. Ignored when V=0.
0	V: Valid. Valid bit for the GCR3 level-1 base table address. 1=the GCR3 base pointer points to a valid table of GCR3 level-1 pointer values. 0=the GCR3 base pointer is ignored by hardware.

The IOMMU uses a guest CR3 level-3 table when DTE[GLX]=10b. The guest CR3 level-3 table is pointed to by the DTE and the structure is the same as the guest CR3 level-2 table. The guest CR3

level-3 table is indexed using PASID[19:18]. The IOMMU ignores any data in the unused portion of the CR3 level-3 table.

The AMD64 long mode page table structure is illustrated in Figure 25. The address translation page tables in Figure 25 contain guest physical addresses that must be translated by the IOMMU to access system memory (PML5E, PML4E, PDPE, PDE, and PTE). A full nested translation is illustrated in Figure 40. The fields in the AMD64 page table formats are the same for corresponding steps of a translation and are replicated here for clarity. Specifically:

- PML5E formats are the same in Figure 26, Figure 32, and Figure 37.
- PML4E formats are the same in Figure 27, Figure 33, and Figure 38.
- PDPE formats are the same in Figure 28, Figure 34, and Figure 39.
- PDE formats are the same in Figure 29 and Figure 35.

2.2.6.4 Support for AMD64 Level 5 (PML5E) Page Table

IOMMU optionally supports Level 5 Guest Page Table containing PML5E entries. Support for this feature is controlled through MMIO Offset 0030h[GATS] and per device DTE[GuestPagingMode] field. When MMIO Offset 0030h[GATS]=01b, IOMMU supports a maximum of five translation levels for guest address translation and the start level is indicated through DTE[GuestPagingMode]. When DTE[GuestPagingMode] = 01b, the GCR3 base table address inside the Guest CR3 table points to a Level 5 Page table containing PML5Es, otherwise it points to a Level 4 Page table containing PML4Es. GVA bits [56:48] are used to index into the Level 5 Page table to select the PML5E.

2.2.6.5 AMD64 4-Kbyte Page Translation

The 4-Kbyte page table formats are defined by the AMD64 processor architecture and interpreted by the IOMMU as in Figure 27, Figure 28, Figure 29, Figure 30, and Table 29. The Page-Map Level-5 Table Address, PML4E, PDPE, PDE, and PTE are guest physical addresses that must be translated by the IOMMU using nested page tables to be system physical addresses. See Section 2.2.3 [I/O Page Tables for Host Translations].

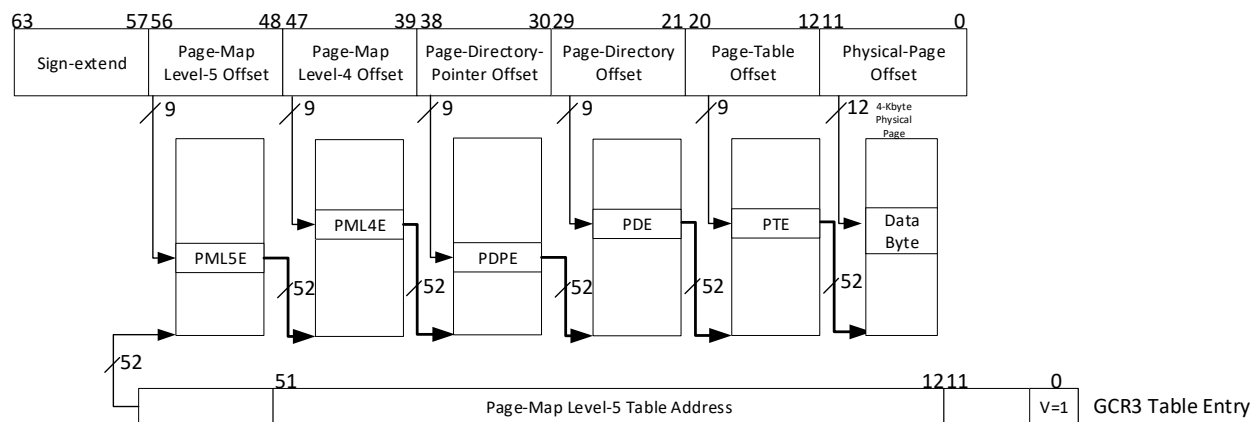

Figure 25: AMD64 Long Mode 4-Kbyte Page Address Translation

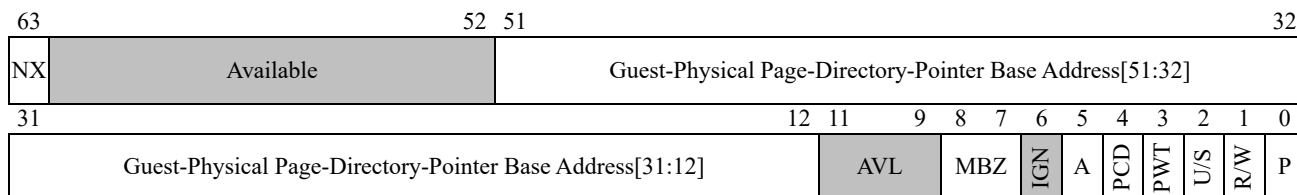

Figure 26: AMD64 Long Mode 4-Kbyte PML5E Format

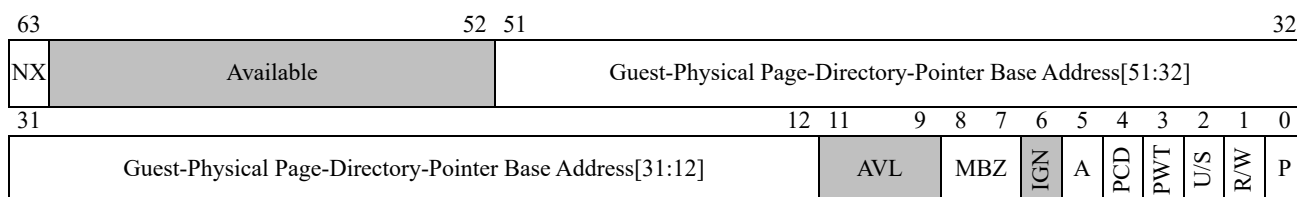

Figure 27: AMD64 Long Mode 4-Kbyte PML4E Format

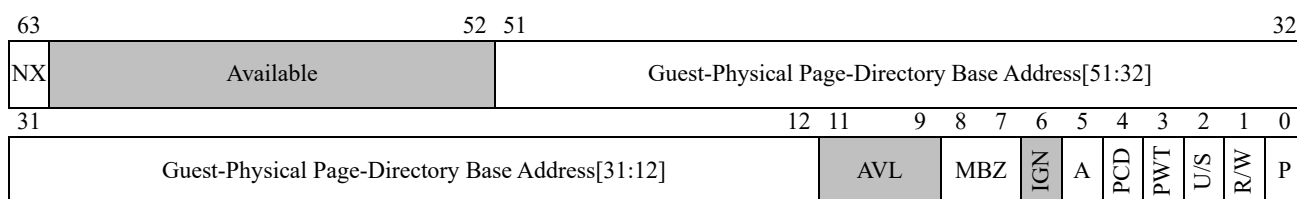

Figure 28: AMD64 Long Mode 4-Kbyte PDPE Format

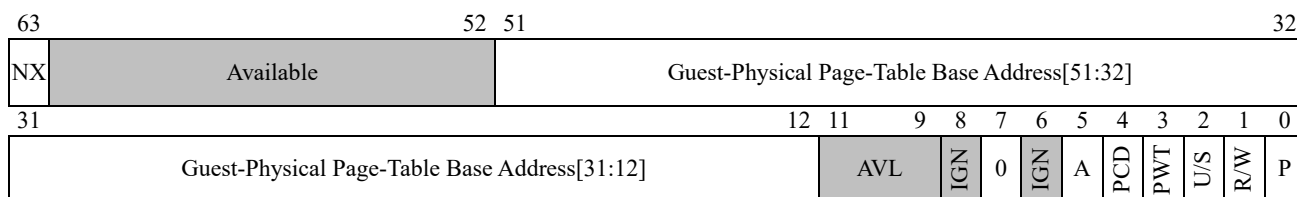

Figure 29: AMD64 Long Mode 4-Kbyte PDE Format

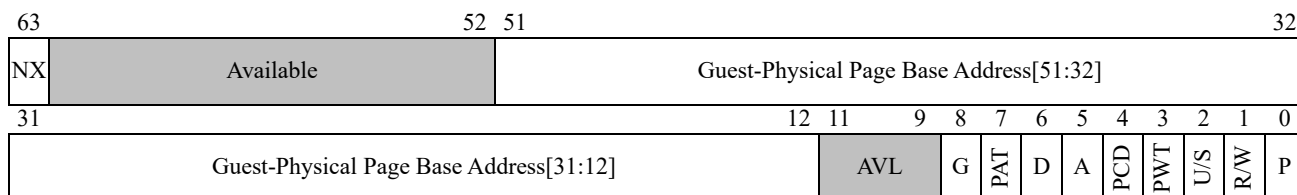

Figure 30: AMD64 Long Mode 4-Kbyte PTE Format

Table 29: IOMMU Interpretation of AMD64 Page Table Fields for 4-Kbyte Page Translation

Bits	Description
63	NX: No execute. 0=fetch for execution is allowed. 1=fetch for execution is blocked. Ignored by the IOMMU if not implemented (see MMIO Offset 0030h[NXSup]). This bit controls the ability to execute code from all physical pages mapped by the table entry. The no-execute protection check applies to all privilege levels; it does not distinguish between supervisor and user-level accesses.
62:52	Available. Ignored by the IOMMU.
51:12	Guest-Physical Page Base Address. IOMMU uses same meaning as AMD64 processor; specifies a guest-physical base address when P=1. For 4-Kbyte pages, bits 11:0 are assumed to be zero; for 2-Mbyte pages, bits 20:0 are assumed to be zero; and for 1-Gbyte pages, bits 29:0 are assumed to be zero.
11:9	AVL: Available. Ignored by the IOMMU.
8	G: Global Page. For 4-Kbyte page PTE this bit is ignored by the IOMMU.
	IGN: Ignored. For 4-Kbyte page PDE this bit is ignored by the IOMMU.
	MBZ: Must be zero. For 4-Kbyte page PML5E, PML4E, and PDPE this bit must be zero.
7	PAT: Page-Attribute Table. For 4-Kbyte page PTE this bit is ignored by the IOMMU.
	MBZ: Must be zero. For 4-Kbyte page PML5E, PML4E, PDPE, and PDE this bit must be zero.
6	D: Dirty. For 4-Kbyte page PTE this bit is present in the lowest level of the page-translation hierarchy. This bit indicates whether the page-translation table or the physical page to which this entry points has been written to by a peripheral. The D bit is set to 1 by the IOMMU the first time the a peripheral writes to the physical page. The D bit is never cleared by the IOMMU. See Section 2.2.7 [Guest and Nested Address Translation] .
	IGN: Ignored. For 4-Kbyte page PML5E, PML4E, PDPE, and PDE this bit is ignored by the IOMMU.
5	A: Accessed. This bit indicates whether the page-translation table or the physical page to which this entry points has been accessed by an IOMMU or processor. The A bit is set to 1 by the IOMMU the first time the table or physical page is either read from or written to. The A bit is never cleared by the IOMMU. See Section 2.2.7 [Guest and Nested Address Translation] .
4	PCD: Page-level Cache Disable. Ignored by the IOMMU.
3	PWT: Page-level Writethrough. Ignored by the IOMMU.
2	U/S: User/Supervisor. IOMMU uses same meaning as AMD64 processor page tables. 0=access is restricted to supervisor level. 1=both user and supervisor access is allowed. Software Note: For a peripheral not using U/S, software should program the bit to signal user mode. If MMIO Offset 0030h[USSup] = 0, this field is ignored.

Table 29: IOMMU Interpretation of AMD64 Page Table Fields for 4-Kbyte Page Translation (Continued)

Bits	Description
1	R/W: Read/Write. This bit controls read/write access to all physical pages mapped by the table entry. 0=access is read-only. 1=access is either read or write. Actual permissions applied to a given page are cumulatively ORed during the page-table walk. The IOMMU converts this status to separate read- and write-enable bits where required.
0	P: Present. Present bit indicates whether the page-translation table or guest physical page is loaded in physical memory. 0=page is not present. 1=page is present. When P=0, all the remaining bits in this data structure entry are available to software and are not used by the IOMMU. Entries with P=0 are never cached in an IOMMU TLB nor will the IOMMU set the Accessed or Dirty bit for the table entry.

2.2.6.6 AMD64 2-Mbyte Page Translation

The 2-Mbyte page table formats are defined by the AMD64 processor architecture and interpreted by the IOMMU as in Figure 32, Figure 33, Figure 34, Figure 35, and Table 30.

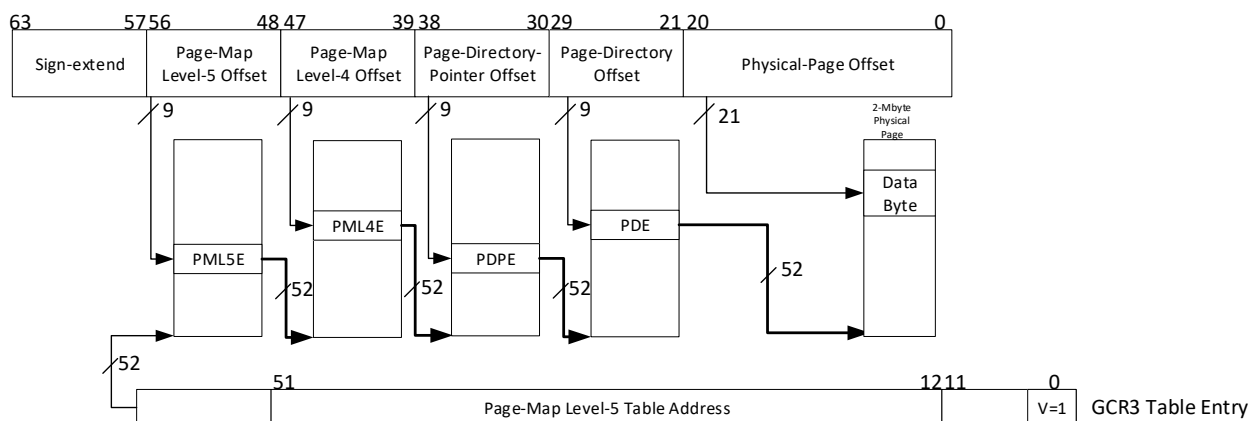

Figure 31: AMD64 Long Mode 2-Mbyte Page Address Translation

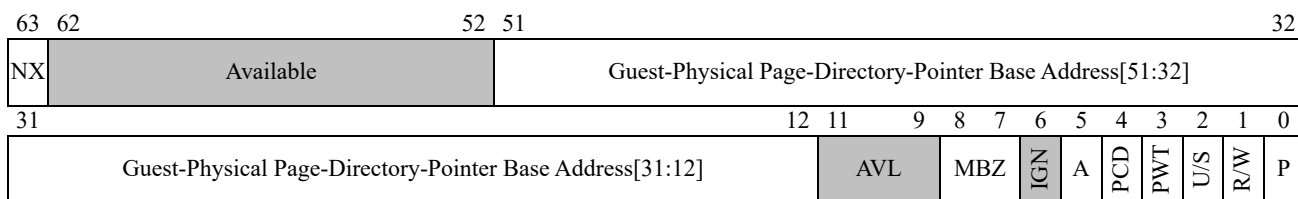

Figure 32: AMD64 Long Mode 2-Mbyte PML5E Format

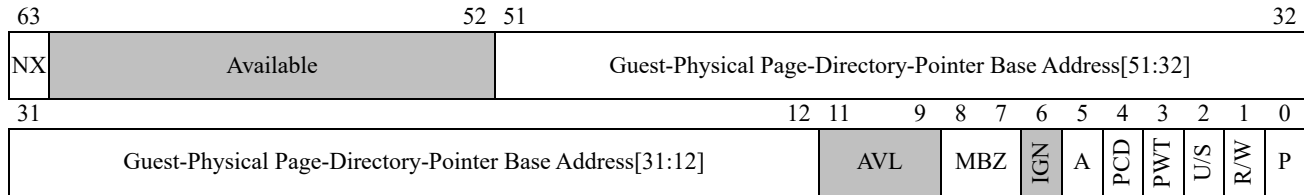

Figure 33: AMD64 Long Mode 2-Mbyte PML4E Format

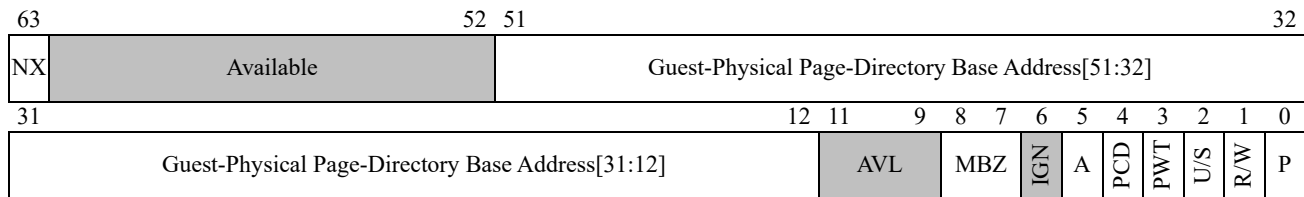

Figure 34: AMD64 Long Mode 2-Mbyte PDPE Format

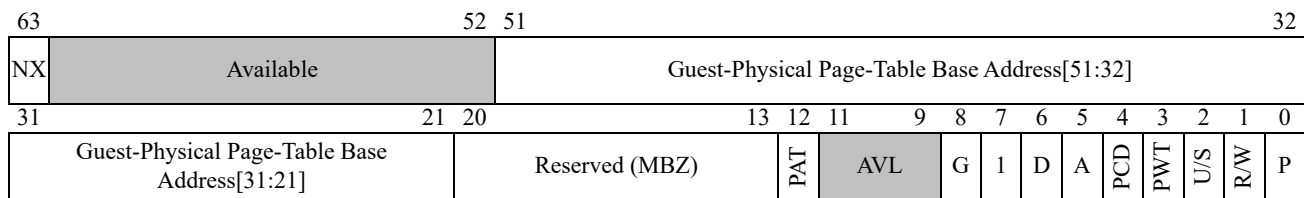

Figure 35: AMD64 Long Mode 2-Mbyte PDE Format

Table 30: IOMMU Interpretation of AMD64 Page Table Fields for 2-Mbyte Page Translation

Bits	Description
63	NX: No execute. 0=fetch for execution is allowed. 1=fetch for execution is blocked. Ignored by the IOMMU if not implemented (see MMIO Offset 0030h [NXSup]).
62:52	Available. Ignored by the IOMMU.
51:21	Guest-Physical Page Base Address[51:21]. Specifies a guest-physical base address when P = 1.
20:13	Guest-Physical Page Base Address[20:13]. For 2-Mbyte page PML5E, PML4E, and PDPE, specifies a guest-physical base address when P = 1. Reserved. For 2-Mbyte page PDE, must be zero.
12	Guest-Physical Page Base Address[12]. For 2-Mbyte page PML5E, PML4E, and PDPE, specifies a guest-physical base address when P = 1. PAT: Page Attribute Table. For 2-Mbyte page PDE, this bit is ignored by the IOMMU.
11:9	AVL: Available. Ignored by the IOMMU.
8	G: Global Page. For 2-Mbyte page PTE, this bit is ignored by the IOMMU. MBZ. For 2-Mbyte page PML5E, PML4E, PDPE, and PDE, this bit must be zero.
7	1b. For 2-Mbyte page PDE, this bit must be 1b. MBZ: Must be zero. For 2-Mbyte page PML5E, PML4E, and PDPE, this bit must be zero.

Table 30: IOMMU Interpretation of AMD64 Page Table Fields for 2-Mbyte Page Translation (Continued)

Bits	Description
6	<p>D: Dirty. For 2-Mbyte page PDE, this bit is only present in the lowest level of the page-translation hierarchy. This bit indicates whether the page-translation table or the physical page to which this entry points has been written to by a peripheral. The D bit is set to 1 by the IOMMU the first time the a peripheral writes to the physical page. The D bit is never cleared by the IOMMU. See Section 2.2.7 [Guest and Nested Address Translation].</p> <p>IGN: Ignored. For 2-Mbyte page PML5E, PML4E, and PDPE, this bit is ignored by the IOMMU.</p>
5	<p>A: Accessed. This bit indicates whether the page-translation table or the physical page to which this entry points has been accessed by an IOMMU or processor. The A bit is set to 1 by the IOMMU the first time the table or physical page is either read from or written to. The A bit is never cleared by the IOMMU. See Section 2.2.7 [Guest and Nested Address Translation].</p>
4	<p>PCD: Page-level Cache Disable. Ignored by the IOMMU.</p>
3	<p>PWT: Page-level Writethrough. Ignored by the IOMMU.</p>
2	<p>U/S: User/Supervisor. IOMMU uses same meaning as AMD64 processor. 0=access is restricted to supervisor level. 1=both user and supervisor access is allowed.</p> <p><i>Software Note: For a peripheral not using U/S, software should set the bit to signal supervisor mode. If MMIO Offset 0030h[USSup] = 0, this field is ignored.</i></p>
1	<p>R/W: Read/Write. This bit controls read/write access to all physical pages mapped by the table entry. 0=access is read-only. 1=access is either read or write. Actual permissions applied to a given page are cumulatively ORed during the page-table walk. The IOMMU converts this status to separate read- and write-enable bits where required.</p>
0	<p>P: Present. Present bit indicates whether the page-translation table or guest physical page is loaded in physical memory. 0=page is not present. 1=page is present. When P=0, all the remaining bits in this data structure entry are available to software and are not examined by the IOMMU. Entries with P=0 are never cached in an IOMMU TLB nor will the IOMMU set the Accessed or Dirty bit for the table entry.</p>

2.2.6.7 AMD64 1-Gbyte Page Translation

The 1-Gbyte page table formats are defined by the AMD64 processor architecture and interpreted by the IOMMU as in [Figure 38](#), [Figure 39](#), and [Table 31](#).

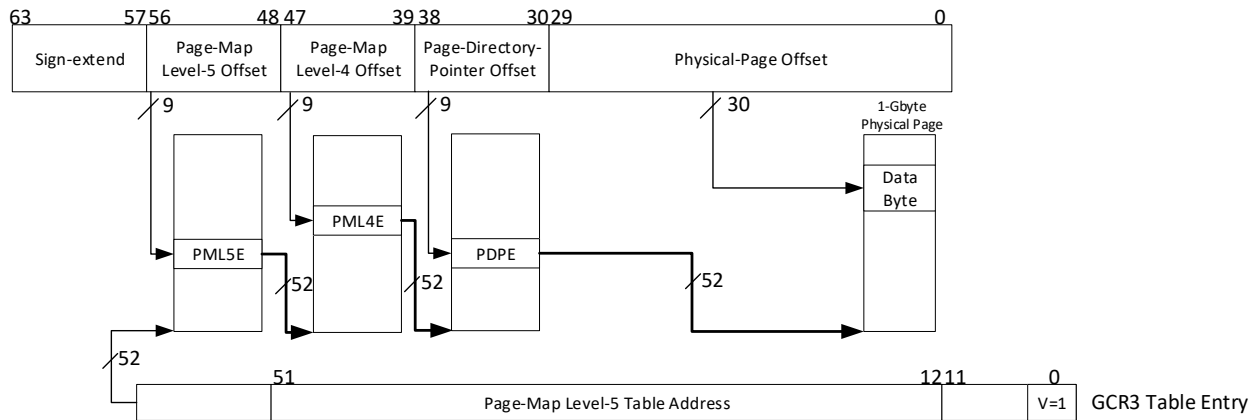

Figure 36: AMD64 Long Mode 1-Gbyte Page Address Translation

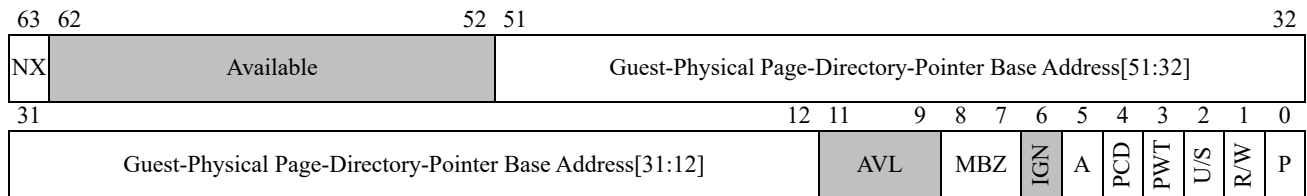

Figure 37: AMD64 Long Mode 1-Gbyte PML5E Format

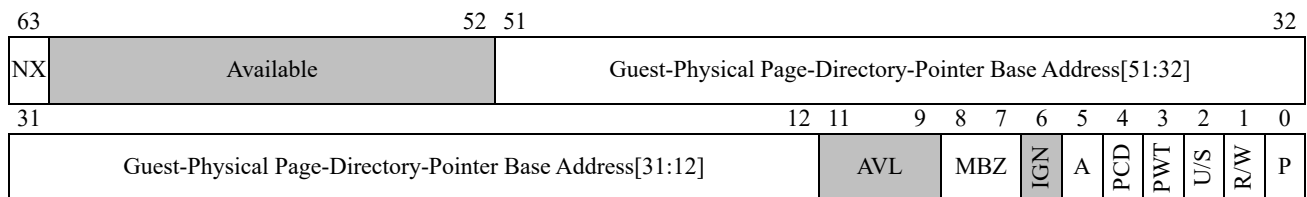

Figure 38: AMD64 Long Mode 1-Gbyte PML4E Format

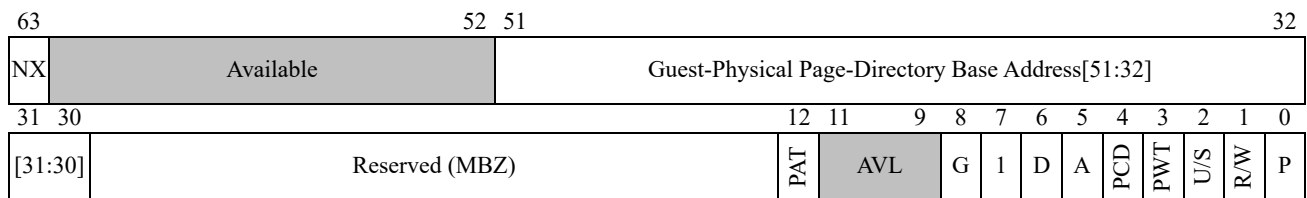

Figure 39: AMD64 Long Mode 1-Gbyte PDPE Format

Table 31: IOMMU Interpretation of AMD64 Long Mode 1-Gbyte Page Table Fields

Bits	Description from AMD64 processor specification
63	NX: No execute. 0=fetch for execution is allowed. 1=fetch for execution is blocked. Ignored by the IOMMU if not implemented (see MMIO Offset 0030h[NXSup]).
62:52	Available. Ignored by the IOMMU.
51:31	Guest-Physical Page Base Address[51:31]. For 1-Gbyte PML5E, PML4E, and PDPE, specifies a guest-physical base address when P=1.
29:13	Guest-Physical Page Base Address[29:13]. For 1-Gbyte PML5E and PML4E, specifies a guest-physical base address when P=1. Reserved. For 1-Gbyte page PDPE, must be zero
12	Guest-Physical Page Base Address[12]. For 1-Gbyte PML5E and PML4E, specifies a guest-physical base address when P = 1. PAT: Page Attribute Table. For 1-Gbyte page PDPE this bit is ignored by the IOMMU.
11:9	AVL: Available. Ignored by the IOMMU.
8	G: Global Page. For 1-Gbyte page PDPE this bit is ignored by the IOMMU. MBZ: For 1-Gbyte page PML5E and PML4E this bit must be zero.
7	1b. For 1-Gbyte page PDPE this bit must be 1b. MBZ: Must be zero. For 1-Gbyte page PML5E and PML4E this bit must be zero.
6	D: Dirty. For 1-Gbyte page PDPE, this bit is only present in the lowest level of the page-translation hierarchy. This bit indicates whether the page-translation table or the physical page to which this entry points has been written to by a peripheral. The D bit is set to 1 by the IOMMU the first time the a peripheral writes to the physical page. The D bit is never cleared by the IOMMU. See Section 2.2.7 [Guest and Nested Address Translation] . IGN: Ignored. For 1-Gbyte page PML5E and PML4E, this bit is ignored by the IOMMU.
5	A: Accessed. IOMMU uses same meaning as AMD64 processor. This bit indicates whether the page-translation table or the physical page to which this entry points has been accessed by an IOMMU or processor. The A bit is set to 1 by the IOMMU the first time the table or physical page is either read from or written to. The A bit is never cleared by the IOMMU. See Section 2.2.7 [Guest and Nested Address Translation] .
4	PCD: Page-level Cache Disable. Ignored by the IOMMU.
3	PWT: Page-level Writethrough. Ignored by the IOMMU.
2	U/S: User/Supervisor. IOMMU uses same meaning as AMD64 processor. 0 = access is restricted to supervisor level. 1 = both user and supervisor access is allowed. Software Note: For a peripheral not using U/S, software should set the bit to select supervisor mode. If MMIO Offset 0030h[USSup] = 0, this field is ignored.

Table 31: IOMMU Interpretation of AMD64 Long Mode 1-Gbyte Page Table Fields (Continued)

Bits	Description from AMD64 processor specification
1	R/W: Read/Write. This bit controls read/write access to all physical pages mapped by the table entry. 0=access is read-only. 1=access is either read or write. Actual permissions applied to a given page are cumulatively ORed during the page-table walk. The IOMMU converts this status to separate read- and write-enable bits where required.
0	P: Present. Present bit indicates whether the page-translation table or guest physical page is loaded in physical memory. 0=page is not present. 1=page is present. When P=0, all the remaining bits in this data structure entry are available to software and are not examined by the IOMMU. Entries with P=0 are never cached in an IOMMU TLB nor will the IOMMU set the Accessed or Dirty bit for the table entry.

2.2.6.8 Nested Page Table Walks

A guest translation can require many page table entries to complete. Careful IOMMU cache design can significantly reduce the penalty of page table walks.

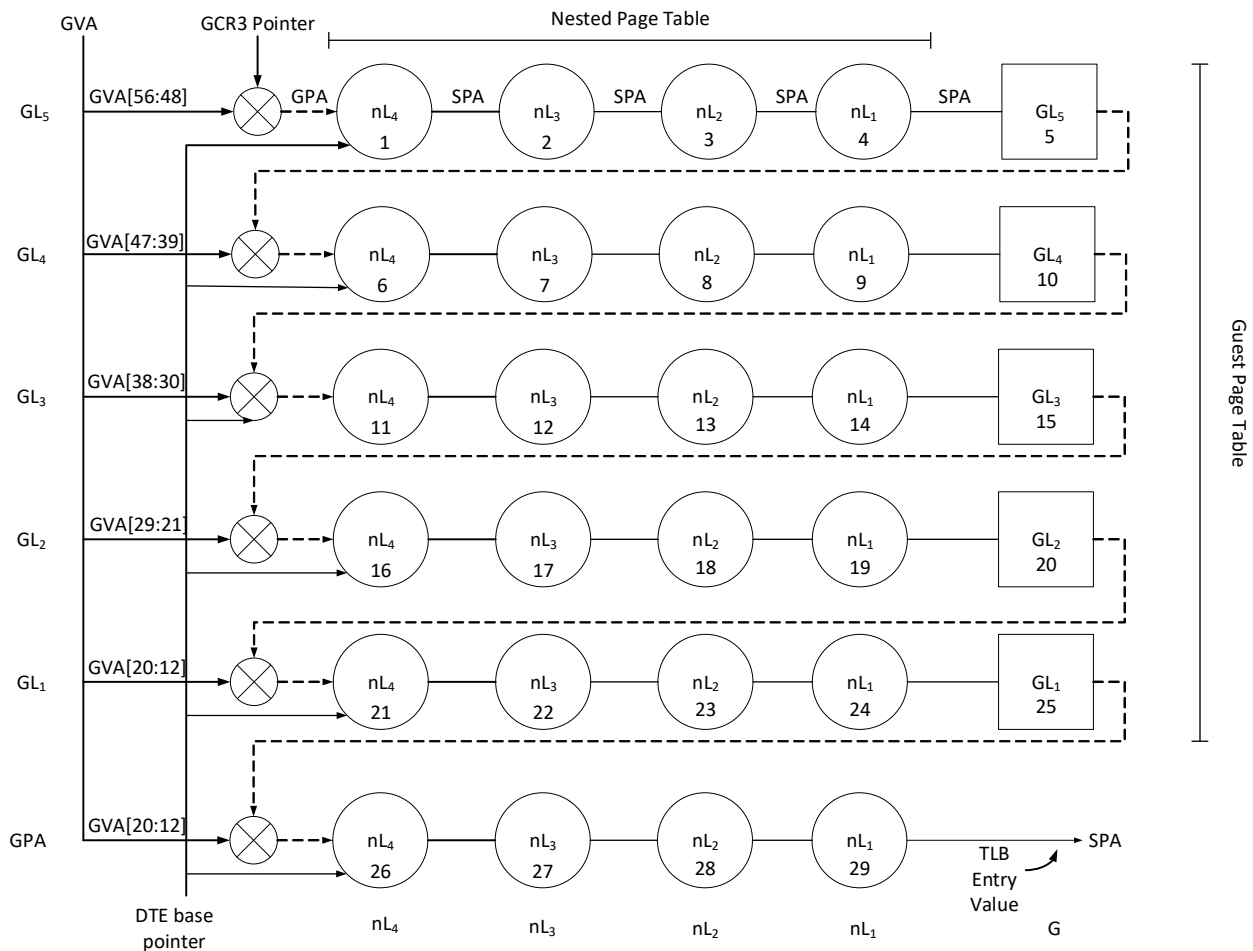

Figure 40: Complete GVA-to-SPA Address Translation

The notation in [Figure 40](#) is adapted from the AMD64 processor architecture specification and uses the notation for processor nested paging. A GVA is shown at the top-left of the figure. The circles indicate GPA translation entries that use the host page table root pointer in the DTE (“DTE base pointer” in the figure). The square entries are GPA entries that are obtained using the guest translation tables pointed to from the GCR3 Table. The figure shows an example of the nested paging translation process when using AMD64 4K Guest and Host page tables. The square entries on the right edge of the figure correspond to [Figure 27](#), [Figure 28](#), [Figure 29](#), and [Figure 30](#). The number of rows corresponds to the number of levels in the guest page table and is smaller when large pages are used. The number of circles on each row may vary depending on the size of the host pages and whether level skipping is used. In the ideal case, an IOMMU TLB cache entry is found containing the required SPA and the translation is complete.

If there is no TLB cache hit, the IOMMU must perform a complete page table walk. The GVA must be processed through four layers of guest address translations in the guest physical address space; this is illustrated down the diagram. Each GPA must be translated into the system physical address space to obtain a series of intermediate translation records, illustrated across the diagram.

2.2.7 Guest and Nested Address Translation

The IOMMU supports host nested address translation and optionally supports guest address translation.

2.2.7.1 Combining Guest and Host Address Translation

The guest and nested (host) translation can be operated in four basic combinations: disabled, together, and each independently. Interrupt remapping is controlled separately by programming DTE[IV].

1. IOMMU address translation is turned off by programming DTE[V]. When DTE[V]=0, no address translation or access checking is performed by the IOMMU for upstream operations from the device. Peripherals have full access to the entire system physical address space. ATS and PRI requests fail.
2. The IOMMU provides GPA-to-SPA address translation by programming DTE[V]=1 and DTE[GV]=0. This operational configuration offers address translation with features such as skip-level tables, large pages (e.g., 8 Kbytes, 16 Kbytes, etc.), and access control. ATS and PRI requests can be enabled.

The next two combinations require that guest address translation is supported by and enabled for the IOMMU (see [MMIO Offset 0030h](#)[GTSup] and [MMIO Offset 0018h](#)[GTEn]).

3. The IOMMU provides GVA-to-GPA (where GPA = SPA) address translation when software programs DTE[V]=1 and DTE[GV]=1 and DTE[Mode]=0, with DTE[IR] and DTE[IW] as desired. This configuration enables the nested translation in pass-through mode with guest translation active. ATS and PRI requests can be enabled.
4. The IOMMU provides GVA-to-SPA translation similar to the nested paging provided by the processor. Software programs DTE[V]=1 and DTE[GV]=1 and the associated translation tables. Accesses are translated using the guest tables for GVA-to-GPA and the underlying nested tables

for GPA-to-SPA. ATS and PRI can be enabled.

2.2.7.2 Calculating Page Table and Page Access Attributes

When guest translation is not supported, the IOMMU calculates read and write attributes as described in [Section 2.2.3 \[I/O Page Tables for Host Translations\]](#).

When guest translation is supported, the IOMMU calculates guest access attributes and nested access attributes for read, write, executable, and user/supervisor permission, and for present, page-accessed, and page-dirty attributes. Note that the updating of control bits in the page tables is visible to the CPU when the IOMMU is sharing guest page tables.

- Read permission - Read permission for a page is first calculated per the method specified by the AMD64 architecture using the guest page tables. Read permissions must also be enabled in the nested page tables used to look up the SPA. Finally, the IR bit in the DTE must be set to enable read permission for the page.
- Write permission - Write permission for a page is determined in a similar manner. First the write permission is calculated using the permission bits in the guest and nested page tables and then combined with the IW bit in the DTE.
- Executable (NX) permission - See sections 2.2.6.1 and 2.2.6.2 for information on calculating executable permissions for a page. The executable permission is ignored when a peripheral supplies a GPA or SPA (i.e., when guest address translation is not used).
- User/supervisor (U/S) permission - When permission checking is supported (EFR[USSup] = 1) and global privileged access abort is disabled (PrivAbtEn = 00b), access permission is calculated as a cumulative-AND of the U/S permission bits in the guest page descriptors. The U/S permission is ignored when a peripheral supplies a GPA or SPA (i.e., when guest address translation is not used).
- Page accessed (A) attribute - The Accessed attribute is not cumulative. The Accessed attribute bit applies to the page containing the next level of the translation table (PML4E[A] bit refers to the PDPE page, etc.). The Accessed bit in the PTE refers to the data page.
- Present (P) attribute - The Present attribute bit applies to the page containing the next level of the translation table (PML4E[P] bit refers to the PDPE page, etc.). The Present bit in the AMD64 PTE refers to the data page. The page-table walk terminates when the first non-present page is discovered.

Implementation Note: As an optimization, a page table walk may be terminated early as long as the end state is not compromised. For example, a write operation to a memory location may be terminated (IO_PAGE_FAULT) at the first descriptor found for a read-only region.

2.2.7.3 Recalculating Read and Write Access Permissions

The IOMMU calculates read and write access status from cached or in-memory information; if the result is access-denied using cached information, the IOMMU recalculates read and write access status from in-memory information when guest address translation is used by the peripheral.

When guest translation is active (see [MMIO Offset 0018h\[GTEn\]](#)), the IOMMU follows the AMD64 long mode address translation requirements for guest virtual addresses and so software is not

required to issue an invalidation command when it promotes guest access privileges or marks a not-present guest page as present. An ATS request or memory reference that results in insufficient guest privileges drawn from a TLB entry may be based on stale information. When the IOMMU detects an access violation using cached guest translation information, it must rewalk the guest page tables to recompute access permission using fresh information read from memory, in the process replacing or discarding cached information. The nested page tables may be read as a consequence of the guest table rewalk. If the retrieved information contains permission control settings that disallow the access then the IOMMU blocks the access; else the IOMMU allows the requested access. An ATS translation request calculates access privileges the same way and returns the computed result. The rewalk may require a full walk of both guest and nested translations (see [Section 2.2.7 \[Guest and Nested Address Translation\]](#)).

Software Note: For a peripheral using ATS, software must determine the invalidation requirements and issue appropriate IOTLB invalidation commands.

Software Note: Software is required to issue an invalidation command when it demotes guest access privileges or removes the guest page (“present to not-present”).

The AMD64 long mode page tables contain information about memory types (PAT) and the IOMMU ignores these bits when it is outside the coherence domain.

2.2.7.4 Updating Accessed and Dirty Bits in the Guest Address Tables

When Guest translation is supported, the IOMMU updates A and D bits in guest page descriptors when guest address translation is used by the peripheral transaction. When the IOMMU updates A and D bits in the guest page descriptors, it uses interlocked operations compatible with the processor update operations. When A and D bits in host page tables are supported [[Section 2.2.3.1](#) and [Section 2.2.3.2](#)] the IOMMU hardware also updates the host page descriptors in manner similar to one described below. Note that the setting of accessed and dirty status bits in the page tables is visible to both the CPU and the peripheral when sharing guest page tables. The IOMMU interlocked operations to update A and D bits must be 64-bit operations and naturally aligned on a 64-bit boundary.

When the IOMMU fetches each needed page table entry, it processes the descriptor differently for memory access requests and for translation requests. For a memory access request, the IOMMU processes the descriptor as follows:

1. Decodes the read and write intent from the memory access.
2. If P=0 in the page descriptor, fail the access.
3. Compare the A & D bits in the descriptor with the read and write intent in the request.
4. If the A or D bits need to be updated in the descriptor:
 - Start atomic operation.
 - Read the descriptor as a 64-bit access.
 - If the descriptor no longer appears to require an update, release the atomic lock with no further action and continue to step 5.
 - Calculate the new A & D bits.
 - Write the descriptor as a 64-bit access.
 - End atomic operation.

5. Continue to the next stage of translation or to the memory access.

For a translation request, the IOMMU processes the descriptor as follows:

1. Decode the read and write intent from the ATS request, including the ATS 1.1 NW bit.
2. If P=0 in the descriptor, return an ATS response with no access (R=W=0).
3. Check the A & D bits in the descriptor against the read and write intent in the translation request.
4. If the descriptor is obtained from the TLB (P=1) and permissions are not adequate to meet the request, discard the TLB entry, rewalk the page table, and re-evaluate the request.
5. If the descriptor has been obtained from a page-table walk, return the indicated permissions.
6. If the A or D bits need to be updated in the descriptor:
 - Start atomic operation.
 - Read the descriptor as a 64-bit access.
 - If the descriptor no longer appears to require an update, release the lock with no further action and continue to step 7.
 - Update the A & D bits.
 - Write the descriptor as a 64-bit access.
 - End atomic operation.
7. Continue to the next stage of translation or return the translation result.

2.2.7.5 Clearing Accessed and Dirty Bits

To clear the Accessed bit in a descriptor, software must modify the page table structure in memory and then invalidate the affected address range in the IOMMU for all devices using the translation table.

To clear the Dirty bit in an AMD64 descriptor, software must mark the PTE in memory as not-present (PR=0) and invalidate the affected address range in the IOMMU for all devices using the translation table. When the invalidation is complete, the Dirty bit may be examined or changed. In general, the Dirty bit is expected to be used to determine whether a page needs to be written to disk as part of a page-out operation.

2.2.7.6 Calculating PCIe[®] Read and Write Attributes for an ATS Response

When translating addresses, the IOMMU must convert between page table semantics and PCIe semantics using [Table 32](#).

Table 32: AMD64 Access Privilege Conversion Table for ATS Request

PTE		ATS Request: NW	IOMMU Action	ATS Response	
P	RW			R	W
0	X	X	Issue ATS response.	0	0

Table 32: AMD64 Access Privilege Conversion Table for ATS Request (Continued)

PTE		ATS Request: NW	IOMMU Action	ATS Response	
P	RW			R	W
1	0	0	If TLB hit, rewalk and reevaluate using in-memory page table entry.	—	—
			If TLB miss, walk page table, set A, and issue ATS response.	1	0
1	0	1	Set A and issue ATS response.	1	0
1	1	0	Set A & D and issue ATS response.	1	1
1	1	1	Set A and issue ATS response.	1	0

The page table contains a present bit (P) and a read/write bit (R/W), the ATS request includes a no-write hint, and the ATS response requires separate read (R) and write (W) permission bits. A key requirement is that the IOMMU provide an ATS response consistent with page table semantics for privilege promotions. In general, the IOMMU should return results based on the values found in the TLB. The special case for an ATS request are for pages for which the system software may have elevated the access permissions without issuing an invalidation command to the IOMMU. The system software is required to issue an invalidation command when it reduces access permissions (including marking the page not-present with P=0). Specifically, software must invalidate after removing write or execute permission, after changing P from present to not-present, or after changing U/S from user to supervisor.

2.2.7.7 PCIe® TLP PASID Prefix

The PCI-SIG defines a method to add information to a transaction called the TLP prefix. A PCI-SIG ECN uses the TLP prefix to carry added information for a transaction that bears a GVA; this is called the PASID TLP prefix. The IOMMU inspects the first TLP prefix for a PASID TLP prefix when there are multiple and passes through any remaining TLP prefixes (excluding the first if it is a PASID TLP prefix and including the first if it is not a PASID TLP prefix). The IOMMU processes memory transactions with a valid PASID TLP prefix; a PASID TLP prefix used with other types of cycles (e.g., configuration cycles, interrupts) may be ignored by the IOMMU. The IOMMU behavior is undefined when it receives a PASID TLP prefix in a downstream direction. When a PCIe transaction has a PASID TLP prefix containing PNP=0b (see [Figure 41](#) and [Table 33](#)) and an untranslated address, the transaction is said to contain a valid PASID.

The IOMMU processes the PASID TLP prefix when enabled and [MMIO Offset 0018h](#)[GTEn]=1b and [MMIO Offset 0030h](#)[GTSup]=1b. An upstream packet with a valid PASID in the PASID TLP prefix contains a canonical GVA; an upstream packet without a valid PASID in the PASID TLP prefix or with no PASID TLP prefix and an untranslated address contains a GPA. When the PASID TLP prefix contains a valid PASID, the IOMMU processes the packet using the PMR and Exe bits and the guest translation tables. When the PASID TLP prefix does not contain a valid PASID (PNP=1b), the IOMMU ignores the PASID, PMR, and Exe fields.

The PASID TLP prefix contains a 24-bit payload that is interpreted by the IOMMU in the following

way, as specified by the PCI-SIG PCIe ECR for “Process Address Space Identifier Prefix”:

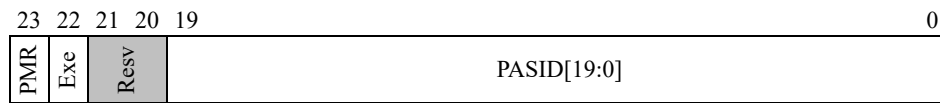

Figure 41: PCIe® TLP PASID Prefix Payload Format

Table 33: PCIe® TLP Prefix Payload Fields

Bits	Description
23	PMR: Privileged Mode Requested. 0=non-privileged (user) request. 1=privileged (supervisor) request.
22	Exe: execute requested. 0=no execute permission requested. 1=execute permission requested.
21	PNP: PASID Not Present. 0=PASID field contains the PASID to use for the transaction. 1=PASID field is not valid.
20	Reserved. <i>Note: Although this bit is reserved, it is passed through the IOMMU as received from the peripheral.</i>
19:0	PASID[19:0]: Guest process address space ID.

When a PCIe transaction contains a valid PASID, the packet contains a GVA. A DeviceID value, consisting of BusID, Device and FunctionID values (BDF) is used to select GPA-to-SPA translation tables and the PASID TLP prefix contains Exe, PMR, PNP, and PASID information. The PASID is used to select the GVA-to-GPA translation tables. When enabled (see [MMIO Offset 0030h](#)[GTSup] and [MMIO Offset 0018h](#)[GTEn]), the IOMMU processes the PASID TLP prefix on memory-access PCIe packets, PCIe ATS packets, and PCIe PRI packets. The IOMMU does not process the PASID TLP prefix on an MSI-X or MSI interrupt packet. If an I/O device supplies a PASID TLP prefix that the IOMMU does not process, the IOMMU reports an error in the event log (see [Section 2.5.9 \[INVALID_DEVICE_REQUEST Event\]](#)). When a PCIe memory transaction contains no valid PASID, the packet contains a GPA and the DeviceID is used to select GPA-to-SPA translation tables.

When the IOMMU receives a TLP prefix with Fmt=001b and Type=100b, it is processed as a PASID TLP prefix and the TLP prefix payload is interpreted to extract the fields in [Table 33](#). If the TLP Prefix Type !=100b, the IOMMU handles the TLP prefix as defined in the PCI-SIG PCIe specifications. Although the PCI-SIG TLP specification allows for multiple TLP prefixes on a single packet, the IOMMU interprets only the first TLP prefix to determine if the transaction contains a PASID. The IOMMU behavior in response to a PASID TLP prefix other than the first prefix is not defined.

2.2.7.8 Maximum PASID value (PASmax)

The maximum PASID value supported by a given IOMMU implementation can be calculated using the value read from the PASmax field of the EFR (see [MMIO Offset 0030h](#)[PASmax]). The maximum PASID value supported is equal to $(2^{\text{PASmax}} - 1)$. Each peripheral may support a smaller value. System software is required to program the guest CR3 tables so that PASID values out-of-range for the peripheral or for the IOMMU are marked not-valid (see [Table 20](#) and [Table 25](#)).

2.2.7.9 Calculating Non-Snoop Accesses Attribute for an ATS Response

In an ATS response, the N field controls whether a device may set the NoSnoop attribute in a DMA response based upon the returned translation. If N=1, the device may only generate DMA with NoSnoop=0. If N=0, the device may use proprietary means to determine how to set NoSnoop.

For ATS responses containing only host translations, the DTE[FC] attribute is used to control the N field.

For ATS responses containing guest translations, if IOMMU Offset 0030h[AttrFWSup]=0, the N field is always set to 1. If IOMMU Offset 0030h[AttrFWSup]=1, the value of the N field is determined by the values of DTE[AttrV], DTE[SnoopAttribute] and DTE[Mode0FC]. See Section 2.2.2.1 Device Table Entry.

2.2.7.10 Extended Coherency Attributes

If MMIO Offset 0030h[AttrFWSup] = 1, the IOMMU supports returning additional coherency information beyond the N field in response to an ATS request. The nature of the coherency information, the mechanisms used to communicate this information and the methods to determine whether an I/O device support receiving this information are outside the scope of this specification.

2.2.8 Guest Virtual APIC Table for Interrupt Virtualization

If the Guest Virtual APIC feature is supported, the IOMMU provides the Guest Virtual APIC Table which is used to virtualize interrupts. When enabled, the IOMMU can cause interrupts to be delivered directly to running guests without hypervisor intervention for a device. When interrupt remapping and interrupt virtualization are both enabled, an incoming device interrupt is first virtualized using the IRTE and then delivered using the AMD virtual interrupt controller. Interrupt virtualization requires compatible support in the IOMMU and the processor.

When MMIO Offset 0030h[GASup]=0, the IOMMU does not support interrupt virtualization using the Guest Virtual APIC Table.

When MMIO Offset 0030h[GASup]=1, device interrupt virtualization is enabled for the IOMMU by programming MMIO Offset 0018h[GAEn]=1, IRTE[GuestMode]=1 to activate interrupt virtualization for the device interrupt, and the Guest Virtual APIC Table Root Pointer in the IRTE to the base address (SPA) of the guest virtual APIC backing page. Further information can be found in Chapter 15 of APM2 (*Advanced Virtual Interrupt Controller*).

2.2.9 Guest I/O Protection

If the IOMMU supports Guest I/O Protection (see MMIO Offset 0030h[GIoSup]), I/O devices that do not support PASID may be used in conjunction with guest address translation. This feature is enabled by setting DTE[GIoV]=1. When enabled, a default PASID of 0 is applied to all non-PASID DMA requests from the enabled peripheral. All features related to guest and nested translation are then applied. Received DMA requests without PASID in the 0xFEEEx_XXXX address range are treated as MSI interrupts and are processed using interrupt remapping rather than address translation.

The guest I/O protection feature may be used in conjunction with peripherals that issue a mix of DMA requests with and without PASID. Requests without a PASID will be modified to use the default PASID of 0. When issuing requests with PASID, the peripheral must be configured to use a

non-zero PASID.

Multiple gCR3 table entries may be programmed to reference the same guest page table. This allows a peripheral to share a guest address space between its requests using the default PASID and requests using a non-zero PASID.

Operating systems are encouraged to use this feature to construct I/O protection buffers using the guest page table format.

IOMMU hardware that supports the Guest I/O Protection feature is capable of walking the nested page tables formed when the OS is virtualized by a Hypervisor. This is not possible if the OS uses the host page table format for I/O protection.

2.3 Starting the IOMMU

Before attempting to access memory-mapped registers, software must allocate a contiguous physical memory range for the registers and program the base address using [IOMMU Base Address Low Register \[Capability Offset 04h\]](#) and [IOMMU Base Address High Register \[Capability Offset 08h\]](#). If [MMIO Offset 0030h\[PCSup\] = 0](#), 16 Kbytes of space must be allocated. If [MMIO Offset 0030h\[PCSup\] = 1](#), 512 Kbytes of space must be allocated.

2.3.1 Data Structure Initialization

To start the IOMMU and activate table walking, etc., use the following procedure after a system reset.

- System firmware must program any implementation-defined registers to prepare for software use of the guest virtual APIC.
- If not previously set, initialize the SMI filter registers (see [Section 2.1.5 \[System Management Interrupt \(SMI\) Controls\]](#)).
- If not previously set, initialize the following registers:
 - the [Device Table Base Address Register \[MMIO Offset 0000h\]](#),
 - the [Command Buffer Base Address Register \[MMIO Offset 0008h\]](#),
 - the [Command Buffer Head Pointer Register \[MMIO Offset 2000h\]](#),
 - the [Command Buffer Tail Pointer Register \[MMIO Offset 2008h\]](#),
 - the [IOMMU Exclusion Base Register / Completion Store Base Register \[MMIO Offset 0020h\]](#) and the [IOMMU Exclusion Range Limit Register / Completion Store Limit Register \[MMIO Offset 0028h\]](#), if used,
 - the [Event Log Base Address Register \[MMIO Offset 0010h\]](#), the [Event Log Head Pointer Register \[MMIO Offset 2010h\]](#) and the [Event Log Tail Pointer Register \[MMIO Offset 2018h\]](#), if used.
- Write the [IOMMU Control Register \[MMIO Offset 0018h\]](#) with [EventLogEn=1b](#) (if used), [CmdBufEn=1b](#), and [IommuEn=1b](#). Other [IOMMU Control Register \[MMIO Offset 0018h\]](#) bits should be set as necessary.
- If using peripheral page requests, software must initialize the PPR Log registers in addition to the other registers before setting [IommuEn=1b](#):
 - [PPR Log Base Address Register \[MMIO Offset 0038h\]](#),

- IOMMU PPR Log Head Pointer Register [MMIO Offset 2030h], and
- IOMMU PPR Log Tail Pointer Register [MMIO Offset 2038h].
- Software must write the IOMMU Control Register [MMIO Offset 0018h] with PPREn = 1b, PPRLogEn = 1b; and, if using interrupts, PprIntEn = 1b.
- Enable virtual interrupt request logging.
- Software should not access the IOMMU Reserved Register [MMIO Offset 1FF8h].

The IOMMU is now operational; it processes device transactions and fetches command buffer entries. When enabled, the IOMMU creates event log entries as events occur.

2.3.2 Making Guest Interrupt Virtualization Changes

Software may change the guest interrupt virtualization information in the IRTE in the following manner, according to the value of RemapEn before the change in the relevant IRTE.

- If RemapEn=0 before the change, changes can be made in any order as long as the last change is to set RemapEn=1.
- If RemapEn=1 before the change, the following steps may be followed to change interrupt virtualization information:
 - Set RemapEn=0 in the entry to disable interrupt virtualization; device-initiated interrupt requests for the DeviceID and vector are processed as IO_PAGE_FAULT events.
 - Update the fields in the IRTE and invalidate the interrupt table (see [Section 2.4.5 \[INVALIDATE_INTERRUPT_TABLE\]](#)).
 - Set RemapEn=1 to virtualize interrupts from the device.

2.4 Commands

The host software controls the IOMMU through a shared circular buffer in system memory. The host software writes commands into the buffer and then notifies the IOMMU of their presence by writing a new value to the tail pointer. The IOMMU then reads the commands and executes them at its own pace. The shared command buffer organization was chosen to allow the host software to send commands in batches to the IOMMU, while allowing the IOMMU to set the pace at which commands are actually executed.

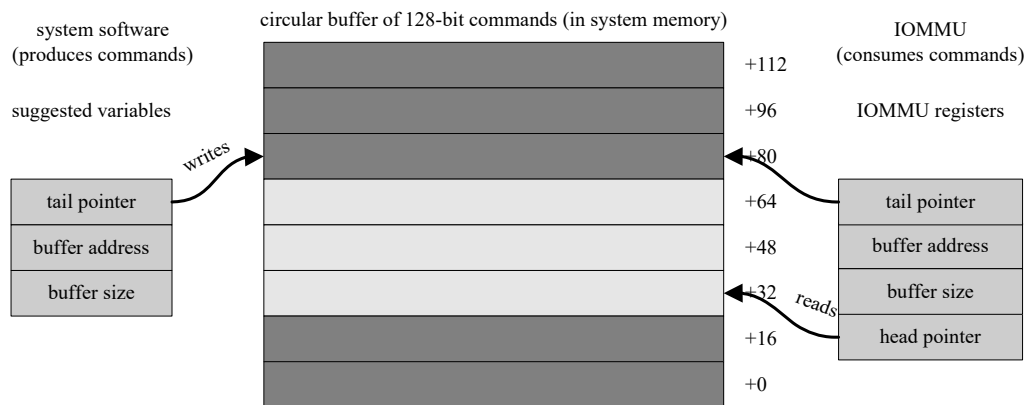

Figure 42: Command Buffer in System Memory

The [Command Buffer Base Address Register \[MMIO Offset 0008h\]](#) is used to program the system physical base address and size of the command buffer. The command buffer occupies contiguous physical memory starting at the programmed base address, up to the programmed size. The size of the command buffer must be a multiple of 4 Kbytes (to facilitate “modulo N” indexing for circularity) and can be as large as 32768 entries (corresponding to a 512-Kbyte buffer). The address of the command buffer must be aligned to a multiple of 4 Kbytes.

In addition to the [Command Buffer Base Address Register \[MMIO Offset 0008h\]](#), the IOMMU maintains two other registers associated with the command buffer: the [Command Buffer Head Pointer Register \[MMIO Offset 2000h\]](#), an offset from the base address, which points to the next command that the IOMMU can fetch, and the [Command Buffer Tail Pointer Register \[MMIO Offset 2008h\]](#), an offset from the base address, which points to the next command to be written by software. These registers are located in IOMMU MMIO space. When the [Command Buffer Base Address Register \[MMIO Offset 0008h\]](#) register is written, the [Command Buffer Head Pointer Register \[MMIO Offset 2000h\]](#) and the [Command Buffer Tail Pointer Register \[MMIO Offset 2008h\]](#) are reset to the 0. When the [Command Buffer Head Pointer Register \[MMIO Offset 2000h\]](#) and the [Command Buffer Tail Pointer Register \[MMIO Offset 2008h\]](#) are equal the command buffer is empty. The [Command Buffer Head Pointer Register \[MMIO Offset 2000h\]](#) is incremented by the IOMMU after reading a command from the command buffer.

The IOMMU fetches commands in FIFO order from the command buffer. The IOMMU must never refetch a command. The IOMMU must set the Coherent bit in the HyperTransport™ packet when issuing command buffer read requests. Although the IOMMU fetches commands in order, it may execute them concurrently. Software may use the `COMPLETION_WAIT` command when synchronization is required.

All commands read by the IOMMU take the form of a 4-bit opcode together with two operands, which may be respectively 60 and 64 bits long, for a total of 128 bits (16 bytes) per command:

31	28 27	0
First opcode dependent operand [31:0]		+00
Opcode[3:0]	First opcode dependent operand [59:32]	+04
Second opcode dependent operand [31:0]		+08
Second opcode dependent operand [63:32]		+12

Figure 43: Generic Command Buffer Entry Format

The `COMMAND_HARDWARE_ERROR` (Section 2.5.7 [COMMAND_HARDWARE_ERROR Event]) and `ILLEGAL_COMMAND_ERROR` (Section 2.5.6 [ILLEGAL_COMMAND_ERROR Event]) events cause the IOMMU to halt command processing. If a command buffer entry causes one of these errors, the command head pointer does not advance. Note that the head pointer may have advanced past the command in error. Other activities of the IOMMU, including translations, error logging, and table walks, continue to be processed. Software is required to examine the IOMMU status and event log information to resolve the situation. Command processing is restarted by using the `CmdBufEn` control bit in the `IOMMU Control Register` [MMIO Offset 0018h] and status may be determined from `CmdBufRun` in `IOMMU Status Register` [MMIO Offset 2020h].

To restart the IOMMU command processing after the IOMMU has halted it, use the following procedure.

- Wait until `CmdBufRun=0b` in the `IOMMU Status Register` [MMIO Offset 2020h] so that all commands complete processing as the circumstances allow. `CmdBufRun` must be `0b` to modify the command buffer registers properly.
- Set `CmdBufEn=0b` in the `IOMMU Control Register` [MMIO Offset 0018h].
- As necessary, change the following registers (e.g., to relocate the command buffer):
 - the `Command Buffer Base Address Register` [MMIO Offset 0008h],
 - the `Command Buffer Head Pointer Register` [MMIO Offset 2000h], and
 - the `Command Buffer Tail Pointer Register` [MMIO Offset 2008h].
- Any or all command buffer entries may be copied from the old command buffer to the new and software must set the head and tail pointers appropriately.
- Write the `IOMMU Control Register` [MMIO Offset 0018h] with `CmdBufEn=1b` and `ComWaitIntEn` as desired.

The IOMMU now processes command buffer entries.

2.4.1 COMPLETION_WAIT

The `COMPLETION_WAIT` command allows software to serialize itself with IOMMU command processing. The `COMPLETION_WAIT` command does not finish until all older commands issued since a prior `COMPLETION_WAIT` have completely executed.

Implementation Note: The `COMPLETION_WAIT` command may wait to finish after all older commands complete, including prior `COMPLETION_WAIT` commands. If there are no prior `COMPLETION_WAIT` commands in the command buffer, the `COMPLETION_WAIT` command finishes after all older commands. See important considerations in Section 2.4.11 [IOMMU Ordering

Rules].

For example, system software that wishes to reclaim pages formerly made available to devices should use the following procedure:

- Mark the page table entry (or entries) not present in the IOMMU's tables.
- Issue appropriate page invalidate commands to the IOMMU.
- Issue a `COMPLETION_WAIT` command to the IOMMU. When the `COMPLETION_WAIT` has finished, the IOMMU is designed to ensure that there are no transactions in flight anywhere in the system fabric that read or write the invalidated pages.

Both $s = 1$ and $i = 1$ may be specified in the same `COMPLETION_WAIT` command.

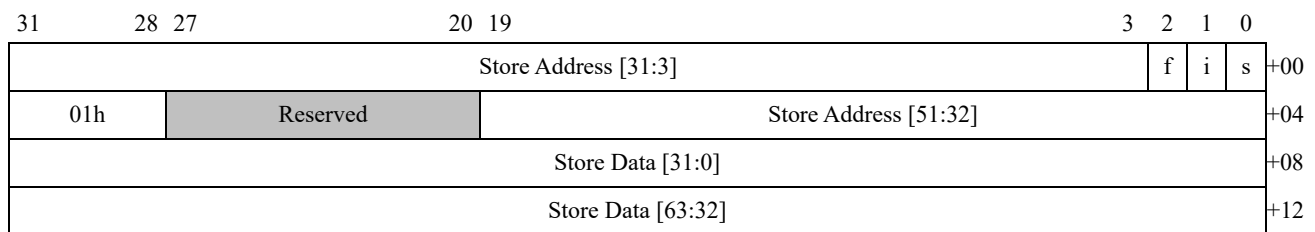

Figure 44: COMPLETION_WAIT Command Format

Table 34: COMPLETION_WAIT Fields

Bits	Description
31:3 +00	Store Address[31:3]. The lower portion of the SPA into which the IOMMU may store the Store Data.
2 +00	f: flush queue. 0=all previous commands until <code>COMPLETION_WAIT</code> have finished, but IOMMU is allowed to start execution of subsequent independent commands. 1=command queue is strictly executed in order, subsequent commands are not launched and executed until <code>COMPLETION_WAIT</code> finishes.
1 +00	i: completion interrupt. 0=the IOMMU does not set MMIO Offset 2020h[ComWaitInt] . 1=the IOMMU sets MMIO Offset 2020h[ComWaitInt] . See Capability Offset 10h[MsiNum] .
0 +00	s: completion store. 0=the IOMMU does not write the Store Data value to the Store Address. 1=the IOMMU writes the specified 64-bit Store Data value to the Store Address. Software can use this write to update a semaphore indicating to the waiting process that it can continue execution. The address written by the <code>COMPLETION_WAIT</code> must be located in system memory. <i>Implementation Note: The write operation must be coherent and not in the isochronous channel. Hardware must not set the PassPw bit when performing this write.</i>
31:28 +04	01h. <code>COMPLETION_WAIT</code> command number.
27:20 +04	Reserved.
19:0 +04	Store Address[51:32]. The lower portion of the SPA into which the IOMMU may store the Store Data.

Table 34: COMPLETION_WAIT Fields (Continued)

Bits	Description
31:0 +08	Store Data[31:0]. The lower portion of the Store Data.
31:0 +12	Store Data[63:32]. The upper portion of the Store Data.

2.4.2 INVALIDATE_DEVTAB_ENTRY

When system software changes a Device Table entry, it must instruct the IOMMU to invalidate that DeviceID from its internal caches. The IOMMU is then forced to reload the Device Table entry before DMA from the device is allowed. The IOMMU may reload the Device Table entry any time after the invalidation has completed.

When software invalidates a DeviceID corresponding to an IOMMU-aware device with its own IOTLB, it should immediately follow INVALIDATE_DEVTAB_ENTRY with an INVALIDATE_IOTLB_PAGES targeted at the same DeviceID and sized to invalidate the full 64-bit address space for the given DeviceID. For a multi-function device this only invalidates the IOTLB entries for the specified function.

Note that this command does not invalidate translation cache entries, since they may be in use by other devices sharing the same DomainID. If the DomainID is not shared, software should issue INVALIDATE_IOMMU_PAGES for the DomainID.

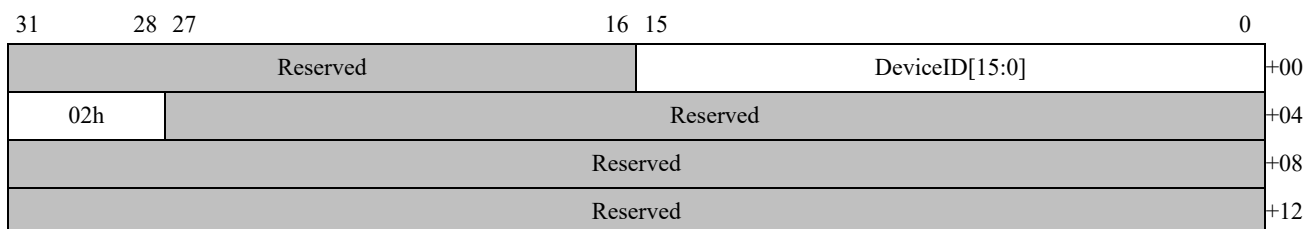
**Figure 45: INVALIDATE_DEVTAB_ENTRY Command Format****Table 35: INVALIDATE_DEV_TAB_ENTRY Fields**

Bits	Description
31:16 +00	Reserved.
15:0 +00	DeviceID[15:0] .
31:28 +04	02h . INVALIDATE_DEV_TAB_ENTRY command number.
27:20 +04	Reserved.

Table 35: INVALIDATE_DEV_TAB_ENTRY Fields (Continued)

Bits	Description
31:0 +08	Reserved.
31:0 +12	Reserved.

2.4.3 INVALIDATE_IOMMU_PAGES

The INVALIDATE_IOMMU_PAGES command instructs the IOMMU to invalidate a range of entries in its translation cache for the specified DomainID. The size of the invalidate command is determined by the S bit and the address. The INVALIDATE_IOMMU_PAGES command must appear as a single atomic operation to the translation engine.

Software Note: When issuing INVALIDATE_IOMMU_PAGES commands, the size of each invalidate must be greater than or equal to the size of the largest page being invalidated.

Implementation Note: IOMMU implementations are not required to provide optimal support for all of the possible invalidation request sizes. The IOMMU is free to invalidate more than just exactly the requested range of addresses, up to and including its entire translation cache if necessary.

Implementation Note: When a guest physical address translation is invalidated, the guest virtual address translations that depend on it must also be invalidated. The IOMMU is permitted to invalidate all guest virtual translations for the DomainID when a guest physical address translation is invalidated.

Software Note: To invalidate the guest translation information for a single process address space, issue an INVALIDATE_IOMMU_PAGES command with GN=1, PASID and DomainID as needed, PDE=1, S=1, and Address[63:12]=7_FFFF_FFFF_FFFFh. The IOMMU invalidates all translation information associated with the DomainID for both nested and guest levels when S=1, PDE=1, GN=0, and Address[63:12]=7_FFFF_FFFF_FFFFh.

Software Note: When the IOMMU is configured to update Accessed and Dirty bits, software must issue invalidation commands when it resets A or D from 1 to 0.

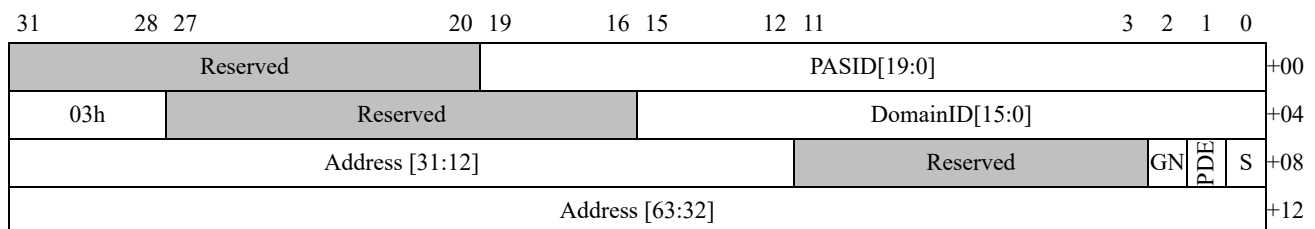

Figure 46: INVALIDATE_IOMMU_PAGES Command Format

Table 36: INVALIDATE_IOMMU_PAGES Fields

Bits	Description
31:20 +00	Reserved.
19:0 +00	PASID[19:0] . Must be zero when two-level translation is not enabled (see DTE[GV] in Table 7); ignored when GN=0.
31:28 +04	03h . INVALIDATE_IOMMU_PAGES command number.
27:16 +04	Reserved.
15:0 +04	DomainID[15:0] .
31:12 +08	Address[31:12]. Address to invalidate.
11:3 +08	Reserved.
2 +08	GN: guest/nested. 0 = Address[52:12] is a GPA so matching nested translations are invalidated and all guest translations within the domain must be invalidated if guest address translation is active for any DeviceID within the domain. 1=Address[52:12] is a GVA and matching guest translations are invalidated for the specified PASID. No nested translations are invalidated. <i>Note: When two-level translation is not supported or not enabled, GN must be zero (see DTE[GV] in Table 7).</i> Implementation Note: Previous versions of this specification indicated that only 'dependent' guest translations needed to be invalidated with GN=0. All known implementations of IOMMU that support guest translation invalidate all guest translations within the specified domain when GN=0.
1 +08	PDE: page directory entries. 0: only the cached page translation entries are flushed. 1: the cached page directory and page translation entries are flushed. If the range of the INVALIDATE_IOMMU_PAGES command covers all of the pages in a page directory entry and PDE = 1, the IOMMU must invalidate the page directory entry in the page directory cache. When GN = 1, the guest translation PDEs and PTE must be invalidated and the nested/host PDE is ignored.
0 +08	S: size. 0=the size of the invalidation is 4 Kbytes. 1=the size of the invalidation is determined by the first zero bit in the address starting from Address[12] (see encoding in Table 14).
31:0 +12	Address[63:32]. Address to invalidate.

2.4.4 INVALIDATE_IOTLB_PAGES

The INVALIDATE_IOTLB_PAGES command is only present in IOMMU implementations that support remote IOTLB caching of translations (see [Capability Offset 00h\[IotlbSup\]](#)). This command instructs the specified device to invalidate the given range of addresses in its IOTLB. The size of the invalidate command is determined by the S bit and the address.

When guest translation is supported, the INVALIDATE_IOTLB_PAGES command optionally supports PASID and software may program GN = 1 (see MMIO Offset 0030h[GTSup]) to specify that Address is a GVA to be translated using PASID.

Software Note: The IOMMU does not check the value of DTE[I] before sending the invalidation command to the peripheral.

For more information on the Maxpend and QueueID fields, refer to the PCI Address Translation Services 1.1 Specification or newer and the peripheral documentation.

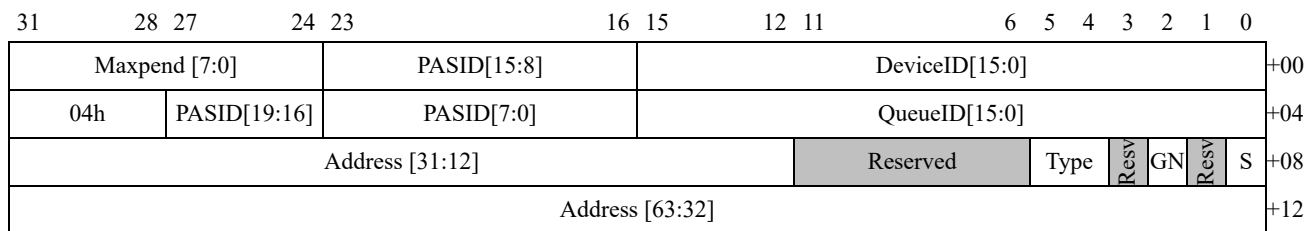

Figure 47: INVALIDATE_IOTLB_PAGES Command Format

Table 37: INVALIDATE_IOTLB_PAGES Fields

Bits	Description
31:24 +00	Maxpend[7:0]. The Maxpend field allows software to control the maximum number of simultaneously in-flight INVALIDATE_IOTLB_PAGES transactions that the IOMMU attempts to initiate with any one particular QueueID. The appropriate value for Maxpend is device-dependent and can be obtained from the device's IOTLB capability.
23:16 +00	PASID[15:8]. Must be zero when two-level translation is not enabled (see DTE[GV] in Table 7); ignored when GN=0.
15:0 +00	DeviceID[15:0].
31:28 +04	04h. INVALIDATE_IOTLB_PAGES command number.
27:24 +04	PASID[19:16]. Must be zero when two-level translation is not enabled (see DTE[GV] in Table 7); ignored when GN=0.
23:16 +04	PASID[7:0]. Must be zero when two-level translation is not enabled (see DTE[GV] in Table 7); ignored when GN=0.
15:0 +04	QueueID[15:0]. The QueueID is used to limit the outstanding invalidations for all virtual devices sharing the queue for devices that implement multiple virtual functions sharing a single invalidation queue. Some devices implement a physical function and multiple virtual functions in which each physical and virtual function has a unique DeviceID. The QueueID is an abstract number representing the shared queue. When the IOMMU receives an invalidate IOTLB command, the command targets the DeviceID. An implementation may have a single queue (likely associated with the physical function) to receive invalidates for the physical function or any of its virtual functions. To manage the flow control of the unified device invalidate-queue, it is not sufficient to track the outstanding entries based on DeviceID.

Table 37: INVALIDATE_IOTLB_PAGES Fields (Continued)

Bits	Description
31:12 +08	Address[31:12]. Address to invalidate.
11:6 +08	Reserved.
5:4 +08	<p>Type: Indicates the type of IOTLB invalidation to perform. If MMIO Offset 0030h[InvIotlbTypeSup]=0, Type must be set to 00b. The mechanisms used to communicate enhanced IOTLB invalidations to an ATS device and the methods to determine whether an I/O device supports Type 01b or 10b IOTLB invalidations are outside the scope of this specification.</p> <p>00b=Standard ATS Invalidation 01b=Invalidate virtual address range without flushing dependent transactions 10b=Invalidate virtual address range and flush all outstanding transactions including those outside the specified address range 11b=Reserved</p>
3 +08	Reserved
2 +08	<p>GN: guest/nested. 0 = Address[52:12] is a guest physical address and matching nested translations are invalidated. The corresponding guest translations must be invalidated if guest address translation is active for any DeviceID within the domain. 1 = Address[52:12] is a guest virtual address and matching guest translations are invalidated for the specified PASID. No nested translations need to be invalidated.</p> <p><i>Note:</i> When two-level translation is not supported or not enabled, GN must be zero (see DTE[GV] in Table 7).</p> <p>Implementation Note: When GN = 0, the IOMMU must invalidate the affected guest translations, but it may invalidate more guest translations for the domain, up to and including all guest translations for the domain.</p>
1 +08	Reserved.
0 +08	<p>S: size. 0=the size of the invalidation is 4 Kbytes. 1=the size of the invalidation is determined by the first zero bit in the address starting from Address[12] (see encoding in Table 14). When S=1, the size of the invalidate is determined by the first zero bit in the address starting from Address[12]. To invalidate the entire contents of an IOTLB, set S=1 and Address[63:32]=7FFF_FFFFh and Address[31:12]=F_FFFFh in the INVALIDATE_IOTLB_PAGES command. When Address[63:32]=FFFF_FFFFh, the IOMMU behavior is undefined.</p>
31:0 +12	Address[63:32]. Address to invalidate.

Since both the IOMMU and the remote IOTLB(s) may contain cached translations for a domain, software must take care to perform invalidations in an order that ensures that no stale translations persist anywhere in the system. After updating a domain's page tables, software should first issue an INVALIDATE_IOMMU_PAGES command for the domain; then, if the domain contains any devices with their own IOTLBs, software should follow with INVALIDATE_IOTLB_PAGES commands for each such device.

When GN=0, Address is a guest physical address and PASID[15:0] is ignored by the IOMMU. The GPA is transmitted to the PCIe peripheral without a TLP prefix. When GN=1, Address is a guest virtual address and software programs PASID[15:0] to indicate the process address space to use. The GVA is transmitted to a PCIe peripheral using the TLP prefix.

Implementation Note: When issuing the completion notification (Section 2.4.1 [COMPLETION_WAIT]), the IOMMU must ensure that all DMA write transactions that have already been translated have been pushed to the host bridge. A way to meet this is:

Prior to sending the invalidation completion indication (interrupt or status write) the IOMMU must:

- Send an upstream Fence command in the base channel if the channel is being used and if the IOMMU supports translating request for more than one upstream stream (more than one unitID is in use).
- Additionally send an upstream Fence command followed by a Flush command in the isochronous channel if the channel is being used and if the IOMMU supports translating requests in both the isochronous and the base channels. The invalidation completion must wait for the Flush response to be received.

Software Note: In order to flow-control invalidations to functions that share a common invalidation queue, software must set the QueueID to a unique identifier that represents the shared queue. The DeviceID of the physical function associated with the virtual functions may be used as the QueueID to insure the IOMMU issues a limited number of outstanding invalidates to the given queue.

Software Note: To completely tear down address translation for a domain, software should:

- update the IOMMU’s in-memory data structures,
- INVALIDATE_DEVTAB_ENTRY for all devices in the domain,
- INVALIDATE_IOMMU_PAGES for the domain, and
- INVALIDATE_IOTLB_PAGES for any IOTLB-capable devices that had been assigned to the domain. After COMPLETION_WAIT on the previous steps the new mapping is guaranteed to be in effect.

2.4.5 INVALIDATE_INTERRUPT_TABLE

The INVALIDATE_INTERRUPT_TABLE command instructs the IOMMU to invalidate all cached interrupt information for the device, including the guest virtual APIC table base pointer (if cached).

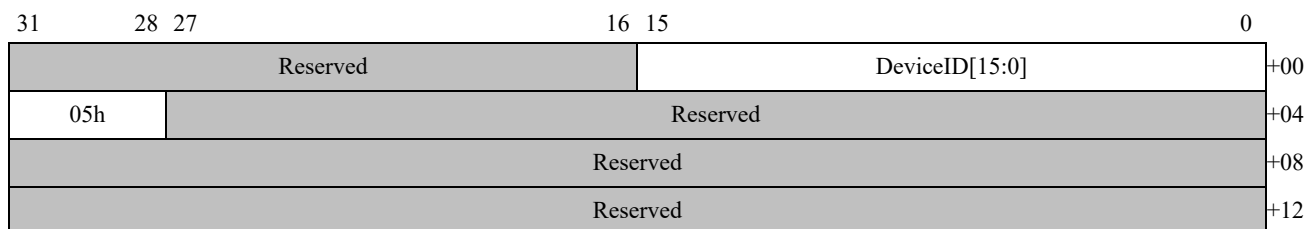

Figure 48: INVALIDATE_INTERRUPT_TABLE Command Format

Table 38: INVALIDATE_INTERRUPT_TABLE command Fields

Bits	Description
31:16 +00	Reserved.
15:0 +00	DeviceID[15:0] .
31:28 +04	05h . INVALIDATE_INTERRUPT_TABLE command number.
27:20 +04	Reserved.
31:0 +08	Reserved.
31:0 +12	Reserved.

2.4.6 PREFETCH_IOMMU_PAGES

When supported ([MMIO Offset 0030h](#)[PreFSup]=1), the PREFETCH_IOMMU_PAGES command instructs the IOMMU to load address translation information into its translation cache for the specified DeviceID. When not supported ([MMIO Offset 0030h](#)[PreFSup]=0), the PREFETCH_IOMMU_PAGES (06h) command is reserved and causes an ILLEGAL_COMMAND_ERROR.

The PREFETCH_IOMMU_PAGES command is advisory so the IOMMU may fetch zero or more translation entries in response to the command, not to exceed the value of PFCnt[7:0]. An IOMMU treats the PREFETCH_IOMMU_PAGES command as an invalid command when [MMIO Offset 0030h](#)[PreFSup]=0. Based on internal status and workloads, the IOMMU may defer fetching the translation information. If an entry is already in the TLB, the IOMMU may adjust LRU or other control tags to lengthen cache residency. The IOMMU calculates permissions for a PREFETCH_IOMMU_PAGES command as it would for a translation that was initiated by device action. Once a translation entry is loaded into the TLB by PREFETCH_IOMMU_PAGES, it is subject to ejection and invalidation like any other entry. A PREFETCH_IOMMU_PAGES command must be processed or discarded (ignored) before processing any following invalidation commands that affect the same virtual addresses. The PREFETCH_IOMMU_PAGES command does not affect the contents of remote IOTLB caches.

When GN=0, Address[63:12] is an GPA so the IOMMU walks nested page tables and PASID is ignored. When GN=1, Address[63:12] is a GVA so the IOMMU walks guest and nested page tables and PASID is used to select the guest table.

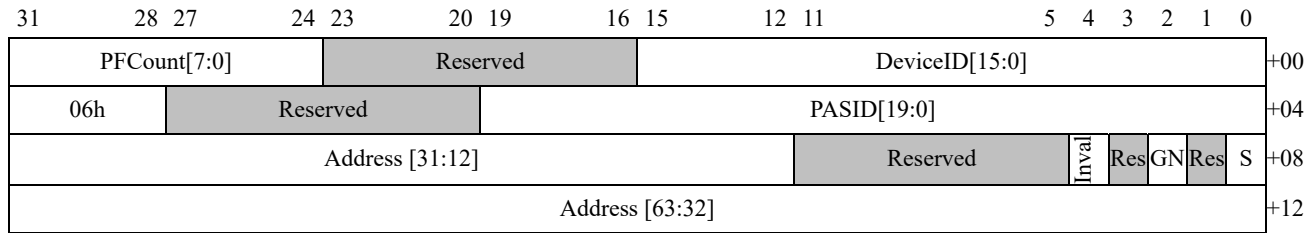

Figure 49: PREFETCH_IOMMU_PAGES Command Format

Table 39: PREFETCH_IOMMU_PAGES Fields

Bits	Description
31:24 +00	PFCOUNT[7:0]: prefetch count. Number of translations to prefetch. Zero is treated as a directive to fetch a single translation.
23:16 +00	Reserved.
15:0 +00	DeviceID[15:0].
31:28 +04	06h. PREFETCH_IOMMU_PAGES command number.
27:20 +04	Reserved.
19:0 +04	PASID[19:0]. Must be zero when two-level translation is not enabled (see DTE[GV] in Table 7). Ignored when GN=0.
31:12 +08	Address[31:12]. Fetch the address translation information for addresses starting with this value. This is a guest virtual address when GN=1 and is a guest physical address when GN=0.
11:5 +08	Reserved.
4 +08	Inval: invalidate first. 0=Prefetch only. 1=Invalidate any matching entry, then prefetch. <i>Implementation Note: the IOMMU may ignore the prefetch portion of the operation but the invalidation is mandatory if Inval=1.</i>
3 +08	Reserved.
2 +08	GN: guest/nested. 0=Address[52:12] is a GPA to be processed through nested translations. 1=reserved (must not be used by software; ignored by hardware).
1 +08	Reserved.
0 +08	S: size. 0=the size of the prefetched page is 4 Kbytes. 1=the size of the prefetched page is determined by the first zero bit in the address starting from Address[12].
31:0 +12	Address[63:32]. Address to invalidate.

When Inval=1, the IOMMU must invalidate or replace any existing translation entries in its cache related to Address[63:12]; in effect, this combines an INVALIDATE_IOMMU_PAGES command with a following PREFETCH_IOMMU_PAGES command. When Repl=1, the IOMMU is advised to replace an existing translation entry in the case of a cache conflict.

For a GVA, the PREFETCH_IOMMU_PAGES command is not supported and GN must be programmed to 0. .

For a GPA, software must program GN=0 and the PASID is ignored; the Address field contains a GPA. The size of the prefetch page is determined by the S bit and the Address. If S=0, the size of the prefetch page is 4 Kbytes. If S=1, the size of the prefetch page is determined by the first zero bit in the address starting from Address[12]. The number of descriptors to fetch is determined by the value of PFCnt[7:0]. The PFCnt value is unsigned and a PFCnt value of 0x00 is treated as 0x01.

2.4.6.1 Event Processing for PREFETCH_IOMMU_PAGES

The IOMMU checks for unusual conditions while processing a PREFETCH_IOMMU_PAGES command. Because such an event would originate as the result of a command in the command queue, neither a Master Abort nor a Target Abort can be caused by a PREFETCH_IOMMU_PAGES command. The PREFETCH_IOMMU_PAGES command never generates an event related to interrupts or interrupt tables.

System hardware events are reported when detected and the IOMMU stops processing the command queue:

- [Section 2.5.4 \[DEV_TAB_HARDWARE_ERROR Event\]](#),
- [Section 2.5.5 \[PAGE_TAB_HARDWARE_ERROR Event\]](#), and
- [Section 2.5.7 \[COMMAND_HARDWARE_ERROR Event\]](#).

These events are reported as soon as detected in the IOMMU hardware event reporting registers (see [Section 2.5.16.2 \[I/O Hardware Event Reporting Registers\]](#)). These events are also reported in the event log when logging is enabled and an interrupt is signaled when enabled.

Other errors may be reported as soon as possible or postponed until a peripheral access uses the TLB entry:

- [Section 2.5.2 \[ILLEGAL_DEV_TABLE_ENTRY Event\]](#),
- [Section 2.5.3 \[IO_PAGE_FAULT Event\]](#).

An IO_PAGE_FAULT event is not reported when processing an PREFETCH_IOMMU_PAGES command; reporting occurs when the entry is used by a peripheral transaction and is controlled by SA or SE in the corresponding DTE when DTE[V]=1. Table entries marked not-valid or not-present cannot be cached by the IOMMU so no error is reported in these cases; the IOMMU will process any error when it rewalks the page tables later to service a peripheral transaction. A PREFETCH_IOMMU_PAGES command does not indicate a read, write, or execute attribute so the IOMMU cannot report an access violation error; the IOMMU will process an access violation when it later services a peripheral transaction.

The following events are never reported as a result of a PREFETCH_IOMMU_PAGES command:

- [Section 2.5.8 \[IOTLB_INV_TIMEOUT Event\]](#),
- [Section 2.5.9 \[INVALID_DEVICE_REQUEST Event\]](#)

- Section 2.5.10 [INVALID_PPR_REQUEST Event], and
- Section 2.5.11 [EVENT_COUNTER_ZERO Event].

If the IOMMU does not prefetch the page table information, a latent problem in the page table structures will not be reported by the IOMMU.

For the purposes of a COMPLETION_WAIT command (see Section 2.4.1 [COMPLETION_WAIT]), the IOMMU may determine that the PREFETCH_IOMMU_PAGES command with Inval=0 completes immediately when the prefetch hint is ignored. A COMPLETION_WAIT command must not signal completion before the completion of a PREFETCH_IOMMU_PAGES command with Inval = 1.

If Prefetch is not supported, this command causes an ILLEGAL_COMMAND_ERROR.

Software Note: When issuing PREFETCH_IOMMU_PAGES commands, the size of the prefetch must be greater than or equal to the size of the largest page being prefetched.

2.4.7 COMPLETE_PPR_REQUEST

When supported, the COMPLETE_PPR_REQUEST command is used to instruct the IOMMU to issue a PCIe completion packet for the specified DeviceID with the supplied CompletionTag. When not supported, the COMPLETE_PPR_REQUEST command is reserved and causes an ILLEGAL_COMMAND_ERROR. See MMIO Offset 0030h[PPRSup] to determine if COMPLETE_PPR_REQUEST is supported.

After software has processed a peripheral page request (see Section 2.6 [Peripheral Page Request (PPR) Logging]), it must issue a COMPLETE_PPR_REQUEST command to the IOMMU for the originating DeviceID.

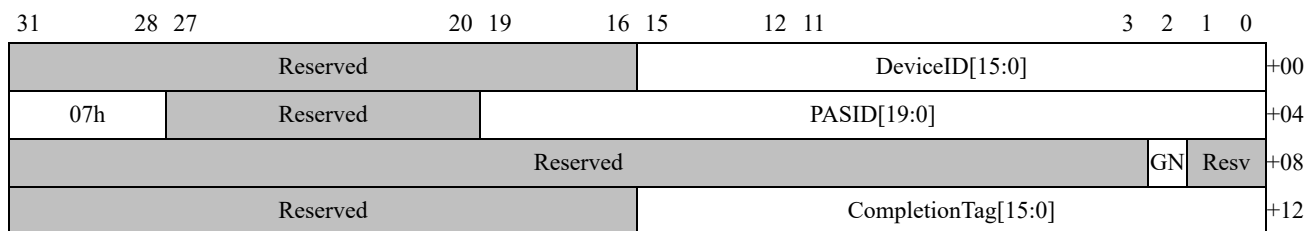

Figure 50: COMPLETE_PPR_REQUEST Command Format

Table 40: COMPLETE_PPR_REQUEST Fields

Bits	Description
31:16 +00	Reserved.
15:0 +00	DeviceID[15:0].
31:28 +04	07h. COMPLETE_PPR_REQUEST command number.

Table 40: COMPLETE_PPR_REQUEST Fields (Continued)

27:20 +04	Reserved.	
19:0 +04	PASID[19:0] . Must be zero when two-level translation is not enabled (see DTE[GV] in Table 7); ignored when GN=0.	
31:3 +08	Reserved.	
2 +08	GN: guest/nested . 0=PASID is ignored. 1=valid PASID. When two-level translation is not enabled, GN must be zero (see DTE[GV] in Table 7).	
1:0 +08	Reserved.	
31:16 +12	Reserved.	
15:0 +12	CompletionTag[15:0]. For PCIe: CompletionTag[15:12] contains the PRI Response Code, CompletionTag[11:9] must be zero and CompletionTag[8:0] contains the PRI Page Request Group Index taken from the PPRtag in the PAGE_SERVICE_REQUEST request entry (see Section 2.6.3 [Peripheral Page Request Entry]). For other bus types: Reserved.	CompletionTag[15:0]. For HyperTransport: Reserved.

Software Note: The IOMMU does not validate the contents of the CompletionTag field. Software must use the PRI Page Request Group Index from the PPR request.

For GVA transactions, software should program GN=1, DeviceID, CompletionTag, and PASID. When GN=1, the IOMMU will insert the PASID into the PCIe TLP prefix. For GPA transactions, software should program GN=0, DeviceID, and CompletionTag. When GN=0, the PASID field is ignored by the IOMMU and no PCIe TLP prefix is inserted.

If an error occurs while processing a COMPLETE_PPR_REQUEST command, it is reported in the event log (see [Section 2.5.10 \[INVALID_PPR_REQUEST Event\]](#)). The contents of CompletionTag[15:0] depend on the peripheral bus type; only transactions for the PCIe bus are defined.

2.4.8 INVALIDATE_IOMMU_ALL

When supported, the INVALIDATE_IOMMU_ALL command instructs the IOMMU to clear all address translation and interrupt remapping information from its translation caches for the all DeviceIDs and all Domains. When not supported, the INVALIDATE_IOMMU_ALL command is reserved and causes an ILLEGAL_COMMAND_ERROR. See [MMIO Offset 0030h](#)[IASup].

The INVALIDATE_IOMMU_ALL command instructs the IOMMU to invalidate all cached information for interrupt remapping and address translation for guest and nested translations, including cached portions of the Device Table, the guest CR3 table, page directory entries, page table entries, and interrupt remapping entries. Use of this command generates an ILLEGAL_COMMAND_ERROR event when not supported by the IOMMU (see [MMIO Offset 0030h](#)[IASup] and [Section 2.5.6 \[ILLEGAL_COMMAND_ERROR Event\]](#)). The INVALIDATE_IOMMU_ALL command does not

affect the contents of any remote IOTLB or IOMMU registers (see [Chapter 3, "Registers"](#)) beyond routine command processing updates. Software must issue an INVALIDATE_IOTLB_PAGES command to flush a remote IOTLB. At the completion of an INVALIDATE_IOMMU_ALL command, all IOMMU caches are empty. The results of outstanding page table walks are discarded. Any pending update operations to the page tables for Accessed and Dirty bits must be completed normally. The operational status of the IOMMU is not affected so that translations, command- and event-processing, address translation service, and peripheral page service processing continue normally. The contents of the MMIO registers are not affected except to advance the [Command Buffer Head Pointer Register \[MMIO Offset 2000h\]](#) beyond the INVALIDATE_IOMMU_ALL command. The IOMMU may start reloading internal caches with information at any time after the INVALIDATE_IOMMU_ALL command completes. The INVALIDATE_IOMMU_ALL command is not supported in a guest command buffer. For a guest, HV should emulated guest IOMMU to have IASup set to 0. If a guest command buffer receives the INVALIDATE_IOMMU_ALL command, it causes an ILLEGAL_COMMAND_ERROR. To invalidate the entire address space of an individual guest, see [Section 2.4.3 \[INVALIDATE_IOMMU_PAGES\]](#).

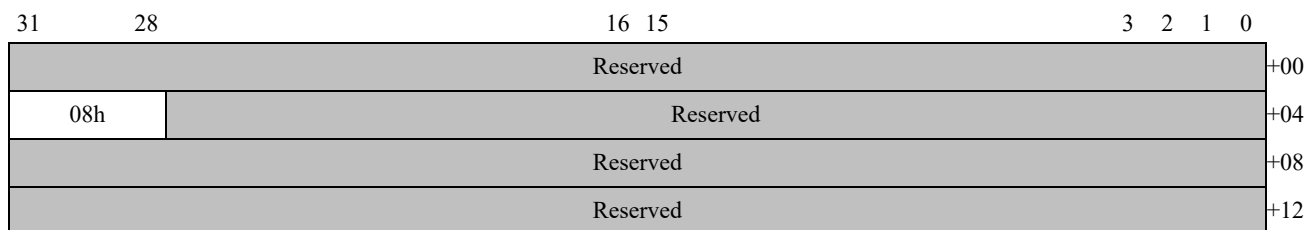

Figure 51: INVALIDATE_IOMMU_ALL Command Format

Table 41: INVALIDATE_IOMMU_ALL Fields

Bits	Description
31:0 +00	Reserved.
31:28 +04	08h. INVALIDATE_IOMMU_ALL command number.
27:0 +04	Reserved.
31:0 +08	Reserved.
31:0 +12	Reserved.

2.4.9 INSERT_GUEST_EVENT Command

When supported, the INSERT_GUEST_EVENT command is always written in pairs with a guest event entry immediately after it into the command buffer, which takes up two command entries. INSERT_GUEST_EVENT instructs the IOMMU to inject the following guest event entry to be

injected to the guest event log of the guest specified by GuestID[15:0].

31	28 27	16 15	0	
Reserved				+00
09h	Reserved	GuestID[15:0]		+04
Reserved				+08
Reserved				+12

IOMMU will not validate the contents of the guest event entry before inject into the guest event log. When the command is only supported, an ILLEGAL_COMMAND_ERROR event is detected. This command is only supported if MMIO[vIommuSup]=1 and MMIO[vIommuEn]=1.

INSERT_GUEST_EVENT command is only used in host command buffer, and should not be used in guest virtualized command buffer. An INSERT_GUEST_EVENT in guest virtualized command buffer will result in an ILLEGAL_COMMAND_ERROR detection.

2.4.10 RESET_VMMIO Command

When Hypervisor wants to reinitialize the vIOMMU MMIO registers of a particular guest, it can inject RESET_VMMIO Command into the Host Command Buffer.

31	30	28 27 26	16 15	0		
VCmd	Reserved	All	Reserved	GuestID	+00	
0Ah		Reserved				+04

Bits	Description
31 +00	VCmd. Virtualized Command Buffer. 1=Reset virtual command buffer for the specific Guest.
30:28 +00	Reserved.
27 +00	All. IAll. 1=Reset the whole virtual IOMMU for the specific Guest. The VMVId in VF Control MMIO Offset 10h will be reset as well.
26:16 +00	Reserved.
15:0 +00	GuestID. Specific the ID of the Guest.
31:27 +04	0Ah. RESET_VMMIO command number.
26:0 +04	Reserved.

This command is only valid when the vIOMMU feature is enabled and only valid in the host command buffer, otherwise it is handled as an invalid command and an `ILLEGAL_COMMAND_ERROR` event is logged into the host event log.

When IOMMU HW detects a vIOMMU fault, the IOMMU might decide to halt the vIOMMU command processing (by clearing the `vCmdRun`) or the whole vIOMMU functionality (by clearing both `vCmdRun` and `vIommuRun`). SW must first clear the corresponding `vIommuEn/vCmdEn` bit(s) then set the Enable bit(s) in order to restart the functionality.

2.4.11 IOMMU Ordering Rules

The IOMMU must ensure that proper ordering is maintained between invalidation command types and between invalidation commands and the translation process.

2.4.11.1 Invalidation Command Ordering Requirements

The IOMMU must ensure that the following command ordering rules are followed for invalidation commands:

- When an `INVALIDATE_IOMMU_PAGES` or `INVALIDATE_INTERRUPT_TABLE` command is received, the IOMMU must ensure that all cache entries associated with any prior `INVALIDATE_DEVTAB_ENTRY` commands are invalidated from the cache before executing the command.
- When an `INVALIDATE_IOTLB_PAGES` command is received, the IOMMU must ensure that all cache entries associated with any prior `INVALIDATE_DEVTAB_ENTRY` or `INVALIDATE_IOMMU_PAGES` commands are invalidated from the cache before executing the command.

2.4.11.2 Invalidation Commands Interaction Requirements

Invalidation commands are considered complete only when the IOMMU can ensure there are no DMA transactions in flight anywhere in the system fabric that relied on translation cache contents prior to invalidation. To ensure this property is achieved, the IOMMU must follow these rules:

- The IOMMU must ensure that read responses for all DMA outstanding read transactions that match the invalidation command have been received by the IOMMU.
 - HyperTransport™ tunnels that support address translation can achieve this property by maintaining a counter that is incremented when a non-posted transaction is forwarded to the processor through the tunnel and is decremented when a response is forwarded from the processor through the tunnel. The invalidation command can be considered complete when the counter reaches zero.

The tunnel may temporarily block upstream traffic to cause the counter to resolve to zero in a timely manner, ensuring that forward progress of the invalidation command is made.
- The IOMMU must ensure that all DMA write transactions that have already been translated have been pushed to the host bridge by:

Prior to sending invalidation completion indication (interrupt or status write), the IOMMU must:

 - Send an upstream Fence command in the base channel if the IOMMU supports translating requests for more than one upstream stream (more than one unitID is in use).
 - Send an upstream Fence command followed by a Flush command in the isochronous channel

if the IOMMU supports translating requests in both the isochronous and the base channels. The invalidation completion must wait for the Flush response to be received.

The IOMMU must ensure that both of these requirements are met prior to executing a subsequent COMPLETION_WAIT command.

An invalidation command matches an outstanding translation if the command:

- Invalidates the Device Table entry for the I/O device that caused a translation to be initiated, or
- Invalidates the virtual address range being translated for a device.

2.5 Event Logging

The IOMMU reports events to the host software by means of a shared circular buffer in system memory. The IOMMU writes event records into the buffer. If the IOMMU needs to report an event but finds that the event log is already full, it sets [MMIO Offset 2020h](#)[EventOverflow]. The IOMMU can be configured to signal an interrupt whenever the event log is written or overflows using [Capability Offset 10h](#)[MsiNum]. The host software increments the IOMMU's head pointer to indicate to the IOMMU that it has consumed event log entries.

When supported, the IOMMU generates event log entries for guest translations as well as host translations using [Capability Offset 10h](#)[MsiNum]. Because some event reports are caused by hardware events that may make it impossible to update the event log, a set of MMIO registers has been defined to report selected event information. The [IOMMU Hardware Event Upper Register](#) [MMIO Offset 0040h] and [IOMMU Hardware Event Lower Register](#) [MMIO Offset 0048h] contain the same information found in an event log entry. The [IOMMU Hardware Event Status Register](#) [MMIO Offset 0050h] contains status bits that indicate that the information in the three registers is valid (HEV) and if an overflow has occurred (HEO). More information is contained in [Section 2.5.16](#) [IOMMU Event Reporting].

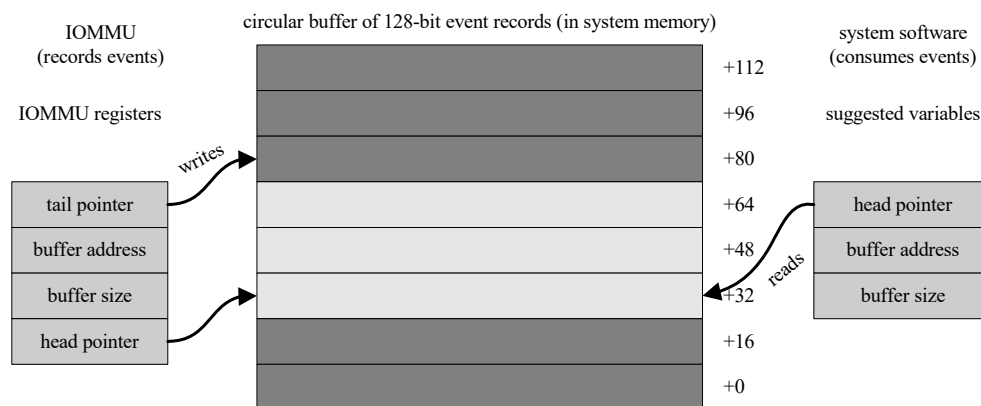

Figure 52: Event Log in System Memory

The [Event Log Base Address Register](#) [MMIO Offset 0010h] is used to program the system physical address and size of the event log. The event log occupies contiguous physical memory starting at the programmed base address, up to the programmed size. The size of the event log must be a multiple of 4 Kbytes (to facilitate “modulo N” indexing for circularity) and can be as large as 32768 entries (cor-

responding to a 512 kilobyte buffer). The address of the event log must be aligned to a multiple of 4 Kbytes.

In addition to the [Event Log Base Address Register \[MMIO Offset 0010h\]](#), the IOMMU maintains two other registers associated with the event log: the [Event Log Head Pointer Register \[MMIO Offset 2010h\]](#), which points to the next event that software will read, and the [Event Log Tail Pointer Register \[MMIO Offset 2018h\]](#), which points to the next event to be written by the IOMMU. These registers are located in MMIO space.

When the [Event Log Base Address Register \[MMIO Offset 0010h\]](#) register is written, the [Event Log Head Pointer Register \[MMIO Offset 2010h\]](#) and the [Event Log Tail Pointer Register \[MMIO Offset 2018h\]](#) are cleared to 0. When the [Event Log Head Pointer Register \[MMIO Offset 2010h\]](#) and the [Event Log Tail Pointer Register \[MMIO Offset 2018h\]](#) are equal, the event log is empty. The [Event Log Tail Pointer Register \[MMIO Offset 2018h\]](#) is incremented by the IOMMU after writing an event to the event log. The event log is full when all slots but one are used. The event log has overflowed when an event occurs that is to be logged and would otherwise consume the last unused slot.

When the Event Log has overflowed, the [EventOverflow](#) bit is set in the [IOMMU Status Register \[MMIO Offset 2020h\]](#) and any data for new events is discarded. An interrupt can be configured to notify software of the new event using [Capability Offset 10h\[MsiNum\]](#); software should check [MMIO Offset 2020h\[EventOverflow\]](#) to determine if the event log data was discarded. The host software must make space in the event log after an overflow by reading entries (by adjusting the head pointer) or by resizing the log. Event logging may then be restarted.

The optional Event Log dual buffer feature adds support for a second event log (Event Log B). See [Section 2.5.17 \[Event Log Dual Buffering\]](#) on page 171.

2.5.1 Event Log Restart Procedure

The IOMMU event logging is disabled after system reset and when the event log overflows. The IOMMU discards event reports until event logging is enabled, setting the [EventOverflow](#) bit in the [IOMMU Status Register \[MMIO Offset 2020h\]](#) to indicate the loss of event information. To restart the IOMMU event logging after the event log overflows, use the following procedure.

- Wait until [EventLogRun=0b](#) in the [IOMMU Status Register \[MMIO Offset 2020h\]](#) so that all log entries are completed as circumstances allow. [EventLogRun](#) must be 0b to modify the event log registers safely.
- Write [EventLogEn=0b](#) in the [IOMMU Control Register \[MMIO Offset 0018h\]](#).
- As necessary, change the following registers (e.g., to relocate or resize the event log).
 - the [Event Log Base Address Register \[MMIO Offset 0010h\]](#),
 - the [Event Log Head Pointer Register \[MMIO Offset 2010h\]](#), and
 - the [Event Log Tail Pointer Register \[MMIO Offset 2018h\]](#).
- Write the [IOMMU Status Register \[MMIO Offset 2020h\]](#) with [EventOverflow = 1b](#) to clear the bit (W1C).
- Write the [IOMMU Control Register \[MMIO Offset 0018h\]](#) with [EventLogEn = 1b](#), and either set [MMIO Offset 0018h\[EventIntEn\]](#) to enable the Event log interrupt or clear the bit to disable it.

The IOMMU now creates event log entries for new events.

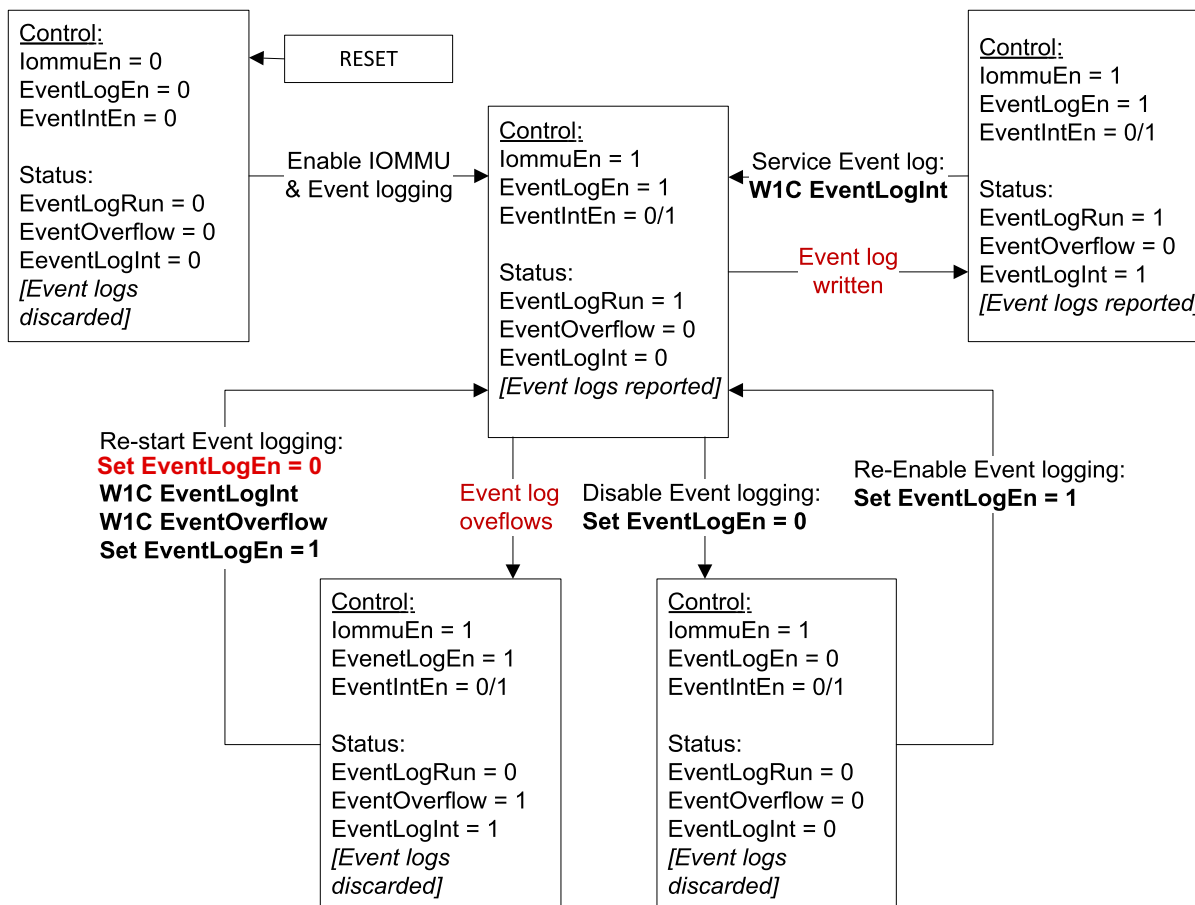

Figure 53: Event Log State Diagram

All events recorded by the IOMMU consist of a 4-bit EventCode together with two operands, which may be respectively 60 and 64 bits long, for a total of 128 bits (16 bytes) per record. Events that are logged because of errors that occur while performing Device Table or page table walks always record the DeviceID and address from the transaction that was being translated.

The IOMMU must set the Coherent bit in the HyperTransport™ packet when generating writes to the event log.

31	28 27	0
First event code dependent operand [31:0]		+00
EventCode[3:0]	First event code dependent operand [59:32]	+04
Second event code dependent operand [31:0]		+08
Second event code dependent operand [63:32]		+12

Figure 54: Generic Event Log Buffer Entry

Events reported by the IOMMU are listed in [Table 42](#). The figures that follow give details for each event type with an EventCode as shown embedded in [Figure 54](#).

Table 42: Event Type Summary

EventCode Name	Value	General Error Type	Details
Reserved	0000b	Reserved.	N/A
ILLEGAL_DEV_TABLE_ENTRY	0001b	Non-zero reserved bit or reserved encoding in DTE.	Table 43
IO_PAGE_FAULT (memory transaction or interrupt remapping)	0010b	DeviceID not in the range specified by the Device Table size.	Table 44
IO_PAGE_FAULT (memory transaction)		PTE programming problems.	
		Virtual address problems.	
		Device attempts to violate page protection settings.	
IO_PAGE_FAULT (interrupt remapping)		IRTE programming problems. Disallowed or malformed interrupt requests.	
DEV_TAB_HARDWARE_ERROR	0011b	Hardware problem as IOMMU reads Device Table.	Table 45
PAGE_TAB_HARDWARE_ERROR	0100b	Hardware problem as IOMMU accesses page table.	Table 46
ILLEGAL_COMMAND_ERROR	0101b	Invalid command buffer entry.	Table 48
COMMAND_HARDWARE_ERROR	0110b	Hardware problem as IOMMU reads command buffer.	Table 47
IOTLB_INV_TIMEOUT	0111b	Invalidation response not received from IOTLB device.	Table 49
INVALID_DEVICE_REQUEST	1000b	Device attempts access to proscribed address range.	Table 50 , Table 51 , Table 64
		Device attempts prohibited access.	
INVALID_PPR_REQUEST	1001b	Invalid or malformed PRI request from peripheral.	Table 52
		Invalid or malformed COMPLETE_PPR_REQUEST command. <i>Note: the COMPLETE_PPR_REQUEST command may be treated as an ILLEGAL_COMMAND_ERROR (see Table 52 for details).</i>	
EVENT_COUNTER_ZERO	1001b	Informational.	Table 67
Reserved	1010b-1111b	Reserved; not used.	N/A

In [Table 43](#) through [Table 53](#), each event type is marked to show that it can be caused only by host software or by hardware.

For details on ILLEGAL_DEV_TABLE_ENTRY events, see [Section 2.5.2](#).

Table 43: ILLEGAL_DEV_TABLE_ENTRY Event Types

Event Type	Cause	IOMMU Response
Non-zero reserved bit in a Device Table entry.	SW	For a translation request or memory access, Target Abort transaction.
Reserved encoding in the IntTabLen field for a Device Table entry with IntCtl=10b.	SW	For a command, abort the command. Create event log entry if enabled.
Reserved encoding in the IoCtl field.	SW	Signal interrupt if enabled (see Capability Offset 10h[MsiNum]).
Reserved encoding in the IntCtl field.	SW	

For details on IO_PAGE_FAULT events, see [Section 2.5.3](#).

Table 44: IO_PAGE_FAULT Event Types

Event Type	Cause	IOMMU Response
Memory transaction		
Reserved paging mode in Device Table entry.	SW	For an untranslated request, Target Abort transaction and create event log entry if enabled. Signal interrupt if enabled (see Capability Offset 10h[MsiNum]). For a translation request, return response with data and with R and W bits set to 0; no event log entry is created. For a command, abort the command and create log entry if enabled. Signal interrupt if enabled (see Capability Offset 10h[MsiNum]).
Page size encoding in a PTE that is smaller than the default page size of the PTE.	SW	
Page size encoding in a PTE that is larger than the default page size of the PTE.	SW	
Invalid level encoding in a page table entry, including exceeding limit specified by MMIO Offset 0030h[GATS, HATS] .	SW	
A non-zero bit in a bit position higher than root page table’s level in DTE. Virtual address bits associated with a skipped page level are not all zero.	SW	
Non-zero reserved bit in a PTE.	SW	
Valid bit not set in page table entry.	HW, SW	
TV bit not set in Device Table entry for untranslated non-interrupt transaction.	HW, SW	
PASID is outside the range specified by MMIO Offset 0030h[PASmax] .	HW, SW	
Device attempts a read transaction to a read protected page.	HW, SW	For untranslated request, Target Abort transaction and create event log entry if enabled. Signal interrupt if enabled (see Capability Offset 10h[MsiNum]). For translation request, return response with data and with R and W bits from the page translation information; no event log entry is created. Never generated by a command.
Device attempts a write transaction to a write protected page.	HW, SW	
Device attempts an instruction fetch from a no-execute page.	HW, SW	
Device attempts to access a supervisor page using user privilege.	HW, SW	Access is blocked and an event log entry is created.
Interrupt remapping		
Interrupt request that addresses an IRTE that is beyond the end of the table.	HW, SW	For interrupt transaction, Target Abort transaction. Create event log entry if enabled. Signal interrupt if enabled (see Capability Offset 10h[MsiNum]). Never generated by a command.

Table 44: IO_PAGE_FAULT Event Types (Continued)

Event Type	Cause	IOMMU Response
Non-zero reserved bit in an IRTE.	SW	
Interrupt request that targets an IRTE with RemapEn=0.	HW, SW	
Interrupt request that targets an IRTE with reserved IntType.	SW	
Interrupt request aborted by entry in Table 10 (Pass fields) or Table 19 (entries causing target abort).	HW, SW	
Interrupt transaction with PASID.	HW	
Upstream SMI request fails to match active SMI filter register (see Section 1.3.10 [SMI Filter]).	HW	Create event log entry if enabled (see MMIO Offset 0018h[SmiFLogEn]). Signal interrupt if enabled (see Capability Offset 10h[MsiNum]). Never generated by a command.
Memory transaction or interrupt remapping		
DeviceID not in the range specified by the Device Table size.	HW	For a translation request, Master Abort transaction. For a memory transaction, Target Abort transaction. For a command, abort the command. Create event log entry if enabled. Signal interrupt if enabled (see Capability Offset 10h[MsiNum]).

For details on DEV_TAB_HARDWARE_ERROR events, see [Section 2.5.4](#).

Table 45: DEV_TAB_HARDWARE_ERROR Event Types

Event Type	Cause	IOMMU Response
Master abort received on Device Table read.	HW	For memory access or translation request, Target Abort transaction. For command, abort the command. Create event log entry if enabled. Log event information in the hardware event registers (see Section 2.5.16.2 [I/O Hardware Event Reporting Registers]). Signal interrupt if enabled (see Capability Offset 10h[MsiNum]).
Target abort received on Device Table read.	HW	
Poisoned data received on Device Table read.	HW	

For details on PAGE_TAB_HARDWARE_ERROR events, see [Section 2.5.5](#).

Table 46: PAGE_TAB_HARDWARE_ERROR Event Types

Event Type	Cause	IOMMU Response
Master abort received on page table access.	HW	For memory access or translation request, Target Abort transaction. For command, abort the command. Create event log entry if enabled. Log event information in the hardware error registers (see Section 2.5.16.2 [I/O Hardware Event Reporting Registers]). Signal interrupt if enabled (see Capability Offset 10h[MsiNum]).
Target abort received on page table access.	HW	
Poisoned data received on page table access.	HW	

For details on COMMAND_HARDWARE_ERROR events, see [Section 2.5.7](#).

Table 47: COMMAND_HARDWARE_ERROR Event Types

Event Type	Cause	IOMMU Response
Master abort received on command buffer read.	HW	Halt command processing. Create event log entry if enabled. Log event information in the hardware event registers (see Section 2.5.16.2 [I/O Hardware Event Reporting Registers]). Signal interrupt if enabled (see Capability Offset 10h[MsiNum]).
Target abort received on command buffer read.	HW	
Poisoned data received on command buffer read.	HW	

For details on ILLEGAL_COMMAND_ERROR events, see [Section 2.5.6](#).

Table 48: ILLEGAL_COMMAND_ERROR Event Types

Event Type	Cause	IOMMU Response
Non-zero reserved bit in a command buffer entry.	HW, SW	Halt command processing. Create event log entry if enabled. Signal interrupt if enabled (see Capability Offset 10h[MsiNum]).
Unsupported command code in a command buffer entry. <i>Note: COMPLETE_PPR_REQUEST is treated as an ILLEGAL_COMMAND_ERROR if not supported (see MMIO Offset 0030h[PPRSup] and Table 52).</i>	SW	
IOMMU receives INVALIDATE_IOTLB_PAGES and does not support IOTLB commands (see Capability Offset 00h[IotlbSup]).	SW	

For details on IOTLB_INV_TIMEOUT events, see [Section 2.5.8](#).

Table 49: IOTLB_INV_TIMEOUT Event Types

Event Type	Cause	IOMMU Response
Invalidation response not received from IOTLB device.	HW	Create event log entry if enabled. Signal interrupt if enabled (see Capability Offset 10h[MsiNum]). Never generated by a command.

For details on INVALID_DEVICE_REQUEST events, see [Section 2.5.9](#) and [Table 64](#).

Table 50: INVALID_DEVICE_REQUEST Event Types (Access)

Event Type	Cause	IOMMU Response
Read request or non-posted write in the interrupt address range.	HW	Target Abort transaction. Create event log entry if enabled. Signal interrupt if enabled (see Capability Offset 10h[MsiNum]). Never generated by a command.
Pretranslated transaction received from an I/O device with I=0 or V=0.	HW	
Port I/O Space request from an I/O device with IoCtl=00b.	HW	
Posted write to the system management address space from an I/O device with SysMgt=00b, or with SysMgt=10b and the message is not an INTx message, or a posted write to the address translation range when Capability Offset 10h[HtAtsResv]=1 (see Table 3).	HW, SW	
Read request or non-posted write in the system management address range (if SysMgt != 11b), or a read or a non-posted-write in the address translation range when Capability Offset 10h[HtAtsResv]=1 (see Table 3). A request with a PASID TLP prefix when guest translation is not supported or not enabled for the DeviceID (see Table 5).	HW, SW	
Posted write to the Interrupt/EOI interrupt address range from an I/O device with IntCtl=00.	HW, SW	
Posted write to a reserved interrupt address range (see Table 3).	HW, SW	
Access to the system management address range when SysMgt=11b or to the port I/O space range when IoCtl=10b, while V=1 and TV=0.	HW, SW	

For details on INVALID_DEVICE_REQUEST events, see [Section 2.5.9](#) and [Table 64](#).

For details on INVALID_PPR_REQUEST events, see [Section 2.5.10](#).

Table 51: INVALID_DEVICE_REQUEST Event Types (Translation Request)

Event Type	Cause	IOMMU Response
Translation request in the interrupt space, port I/O space (if IoCtl=0xb), or system management address range (if SysMgt != 11b).	HW	Target Abort transaction. Create event log entry if enabled. Signal interrupt if enabled (see Capability Offset 10h[MsiNum]).
Translation request in the system management address range when SysMgt=11b or in the port I/O space range when IoCtl=10b, while V=1 and TV=0.	HW	Never generated by a command.
Translation request with I=0 or V=0.	HW	Master Abort transaction. Create event log entry if enabled. Signal interrupt if enabled (see Capability Offset 10h[MsiNum]). Never generated by a command.
DeviceID outside range.		

Table 52: INVALID_PPR_REQUEST Event Summary

Event Type	Cause	IOMMU Response
PRI request received when Capability Offset 00h[EFRSup]=0 or MMIO Offset 0018h[PPREn]=0 or MMIO Offset 0018h[PPRLogEn]=0 .	HW	Target Abort PRI transaction. Create event log entry if enabled. Signal an interrupt if enabled (see Capability Offset 10h[MsiNum]). Never generated by a command.
COMPLETE_PPR_REQUEST command received with GN=1 when guest translation is not enabled.	SW	Create event log entry if enabled. Signal an interrupt if enabled (see Capability Offset 10h[MsiNum]).
NOTE: COMPLETE_PPR_REQUEST is treated as an ILLEGAL_COMMAND_ERROR if PPR is not enabled (Capability Offset 00h[EFRSup]=0 or MMIO Offset 0018h[PPREn]=0 or MMIO Offset 0018h[PPRLogEn]=0). See also Table 48 .		

For details on EVENT_COUNTER_ZERO events, see [Section 2.5.11](#).

Table 53: EVENT_COUNTER_ZERO Event Types

Event Type	Cause	IOMMU Response
Informational; performance counter incremented to equal zero.	SW	Create event log entry if enabled. Signal an interrupt if enabled (see Capability Offset 10h[MsiNum]).

Table 54: RMP_PAGE_FAULT Event Types

Event Type	Cause	IOMMU Response
Hypervisor Memory RMP check failure.	SW	For an untranslated request, Target Abort transaction and create event log entry if enabled. Signal interrupt if enabled (see Capability Offset 10h[MsiNum]). For a translation request, return response with data and with R and W bits set to 0 and create event log entry if enabled. See Capability Offset 10h[MsiNum] .
Guest Memory RMP check failure	SW	
IOMMU Memory RMP check failure	SW	

Table 55: RMP_HARDWARE_ERROR Event Types

Event Type	Cause	IOMMU Response
Master abort received on RMP Table read.	HW	For memory access or translation request, Target Abort transaction. Create event log entry if enabled. Signal interrupt if enabled. See Capability Offset 10h[Msi-Num] .
Target abort received on RMP Table read	HW	
Poisoned data received on RMP Table read	HW	

2.5.2 ILLEGAL_DEV_TABLE_ENTRY Event

When the IOMMU performs a lookup in the Device Table and encounters a Device Table entry that it does not support or that is formatted incorrectly, the IOMMU writes an ILLEGAL_DEV_TABLE_ENTRY event to the event log as listed in [Table 43](#).

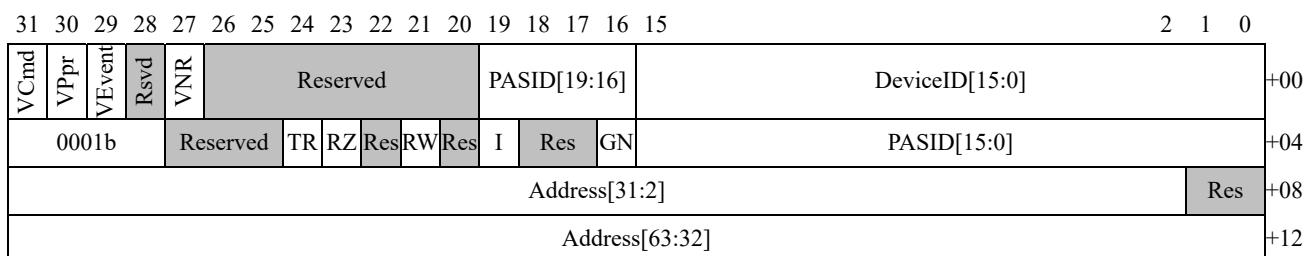
**Figure 55: ILLEGAL_DEV_TABLE_ENTRY Event Log Buffer Entry Format****Table 56: ILLEGAL_DEV_TABLE_ENTRY Event Log Buffer Entry Fields**

Bits	Description
31 +00	VCmd. Virtualized Command Buffer. This event occurs during processing of the virtual command buffer. This bit is reserved and always 0 when vIOMMU feature is disabled.
30 +00	VPpr. Virtualized PPR Log. This event occurs during processing of the virtual PPR log. This bit is reserved and always 0 when vIOMMU feature is disabled.

Table 56: ILLEGAL_DEV_TABLE_ENTRY Event Log Buffer Entry Fields (Continued)

Bits	Description
29 +00	VEvent. Virtualized Event Log. This event occurs during processing of the virtualized event log. This bit is reserved and always 0 when vIOMMU feature is disabled.
28 +00	Reserved.
27 +00	VNR. vIOMMU Non-Recoverable. 0= vIOMMU is fully operational. 1= vIOMMU is corrupted and vIommu context need to be recreated. This bit is reserved and always 0 when vIOMMU feature is disabled.
26:20 +00	Reserved.
19:16 +00	PASID[19:16]: process space ID. The guest PASID[19:16] from the transaction when GN=1; 0h when GN=0.
15:0 +00	DeviceID. Specifies the DeviceID that caused the Device Table lookup. The address of the malformed Device Table entry can be determined using the DeviceID field.
31:28 +04	0001b. Specifies an ILLEGAL_DEV_TABLE_ENTRY.
27:25 +04	Reserved.
24 +04	TR: translation. 1=transaction that caused the Device Table lookup was a translation request. 0=transaction that caused the Device Table lookup was a transaction request.
23 +04	RZ: reserved bit not zero or invalid level encoding. 1=I/O page fault was caused by a non-zero reserved bit in the Device Table entry. 0=I/O page fault was caused by an invalid level encoding in the Device Table entry.
22 +04	Reserved.
21 +04	RW: read-write. 1=transaction that caused the Device Table lookup was a write. 0=transaction that caused the Device Table lookup was a read. RW is only meaningful when TR=0 and I=0.
20 +04	Reserved.
19 +04	I: interrupt. 1=transaction that caused the Device Table lookup was an interrupt request. 0=transaction that caused the Device Table lookup was a memory request.
18:17 +04	Reserved.
16 +04	GN: guest/nested. 0=Transaction contained a GPA. 1=Transaction contained a GVA. See also PASID.
15:0 +04	PASID[15:0]: process space ID. The guest PASID[15:0] from the transaction when GN=1; 0000h when GN=0.
31:2 +08	Address[31:2]. The Address field contains the DVA that the device was attempting to access.

Table 56: ILLEGAL_DEV_TABLE_ENTRY Event Log Buffer Entry Fields (Continued)

Bits	Description
1:0 +08	Reserved.
31:0 +12	Address[63:32] . The Address field contains the DVA that the device was attempting to access.

2.5.3 IO_PAGE_FAULT Event

When the IOMMU performs a lookup in the page tables for a device and encounters an error condition in [Table 44](#), the IOMMU writes the event log with an IO_PAGE_FAULT event as controlled by the SA, SE, IG, and SupIOPF bits (see [Figure 7](#) and [Table 7](#) or [Figure 15](#) and [Table 10](#)).

When supported, IO_PAGE_FAULT events generated by the SMI filter (see [Section 1.3.10 \[SMI Filter\]](#)) are reported with Address[63:0] containing the upstream SMI request address. The [MMIO Offset 0018h\[SmiFLogEn\]](#) bit controls the logging of IO_PAGE_FAULT events reported by the SMI filter; the SA, SE, IG, and SupIOPF bits do not affect SMI filter logging.

I/O page faults detected for translation requests return a translation-not-present response (R=W=0) to the device and are not logged in the event log.

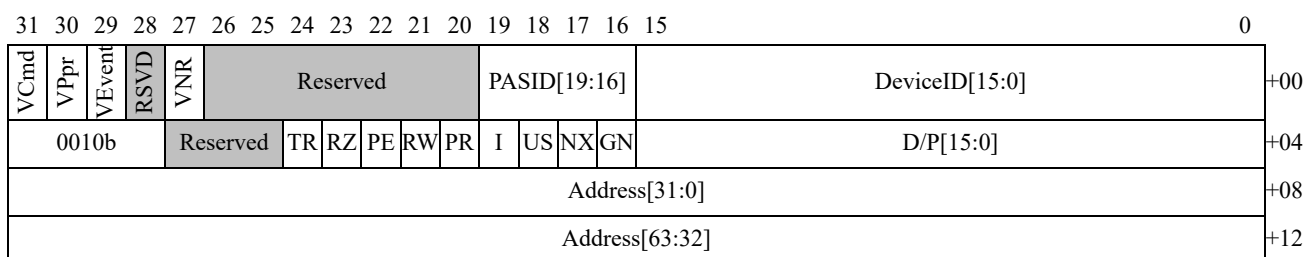
**Figure 56: IO_PAGE_FAULT Event Log Buffer Entry Format****Table 57: IO_PAGE_FAULT Event Log Buffer Entry Fields**

Bits	Description
31 +00	VCmd . Virtualized Command Buffer. This event occurs during processing of the virtualized command buffer. This bit is reserved and always 0 when vIOMMU feature is disabled.
30 +00	VPpr . Virtualized PPR Log. This event occurs during processing of the virtualized PPR log. This bit is reserved and always 0 when vIOMMU feature is disabled.
29 +00	VEvent . Virtualized Event Log. This event occurs during processing of the virtualized event log. This bit is reserved and always 0 when vIOMMU feature is disabled.
28 +00	Reserved .

Table 57: IO_PAGE_FAULT Event Log Buffer Entry Fields (Continued)

Bits	Description
27 +00	VNR. vIOMMU Non-Recoverable. 0= vIOMMU is fully operational. 1= vIOMMU is corrupted and vIommu context need to be recreated. This bit is reserved and always 0 when vIOMMU feature is disabled.
26:20 +00	Reserved.
19:16 +00	PASID[19:16]. The guest PASID[19:16] from the PASID TLP prefix when GN=1; 0h when GN=0. See also D/P below.
15:0 +00	DeviceID. Specifies the DeviceID that caused the Device Table lookup. The address of the Device Table entry can be determined using the DeviceID field.
31:28 +04	0010b. Specifies an IO_PAGE_FAULT entry.
27:25 +04	Reserved.
24 +04	TR: translation. 1=transaction that caused the Device Table lookup was a translation request. 0=transaction that caused the Device Table lookup was a transaction request.
23 +04	RZ: reserved bit not zero or invalid level encoding. 1=I/O page fault was caused by a non-zero reserved bit in the entry. 0=I/O page fault was caused by an invalid level encoding. RZ is only meaningful when PR=1.
22 +04	PE: permission indicator. 1=peripheral did not have the permissions required to perform the transaction. 0=peripheral had the necessary permissions. PE is only meaningful when PR=1. Report PE using cumulative read and write permissions as determined during the page walk as accomplished.
21 +04	RW: read-write. 1=transaction was a write. 0=transaction was a read. RW is only meaningful when PR=1, TR=0, and I=0.
20 +04	PR: present. 1=transaction was to a page marked as present (including V=1b in DTE) or interrupt marked as remapped (RemapEn=1). 0=transaction was to a page marked not present or interrupt marked as blocked (RemapEn=0).
19 +04	I: interrupt. 1=transaction was an interrupt request. 0=transaction was a memory request.
18 +04	US: user-supervisor. 0=Supervisor privileges were asserted. 1=User privileges were asserted.
17 +04	NX: no execute. NX bit as requested by peripheral when the upstream transaction has a PASID TLP prefix; 0 when the upstream transaction lacks a PASID TLP prefix.
16 +04	GN: guest/nested. 0=Transaction used a nested address (GPA). 1=Transaction used a guest address (GVA). See also PASID.

Table 57: IO_PAGE_FAULT Event Log Buffer Entry Fields (Continued)

Bits	Description
15:0 +04	D/P[15:0]: DomainID/PASID[15:0] . When guest translation / PASID is not supported, this field contains the DomainID from the Device Table Entry. For error conditions that lack a valid DomainID, the reported DomainID is zero. When guest translation / PASID is supported, this field contains the guest PASID[15:0] from the PASID TLP prefix when GN=1 (see also PASID[19:0] above); the DomainID from the DTE when GN=0. For error conditions that lack a valid PASID or DomainID, the reported value is zero.
31:0 +08	Address[31:0] . The Address field contains the DVA that the peripheral was attempting to access.
31:0 +12	Address[63:32] . The Address field contains the DVA that the peripheral was attempting to access.

An interrupt transaction that attempts to use a PASID is not allowed and the event is logged with I=1, GN=1, and the D/P and PASID[19:16] fields contain the PASID when event logging is enabled.

2.5.4 DEV_TAB_HARDWARE_ERROR Event

If the IOMMU triggers a hardware error (master abort, target abort, poisoned data, etc.) while accessing the Device Table, the IOMMU writes the event log with a DEV_TAB_HARDWARE_ERROR event (see Table 45). In this case the Address field does *not* contain the DVA the device was attempting to access, but instead contains the system physical address of the failed Device Table access. Information on the hardware error registers is contained in Section 2.5.16.2 [I/O Hardware Event Reporting Registers].

Table 58: Event Log Type Field Encodings

Type	Description
00b	Invalid COMPLETION_WAIT store address in an SNP-enabled system
01b	Master Abort
10b	Target Abort
11b	Data Error

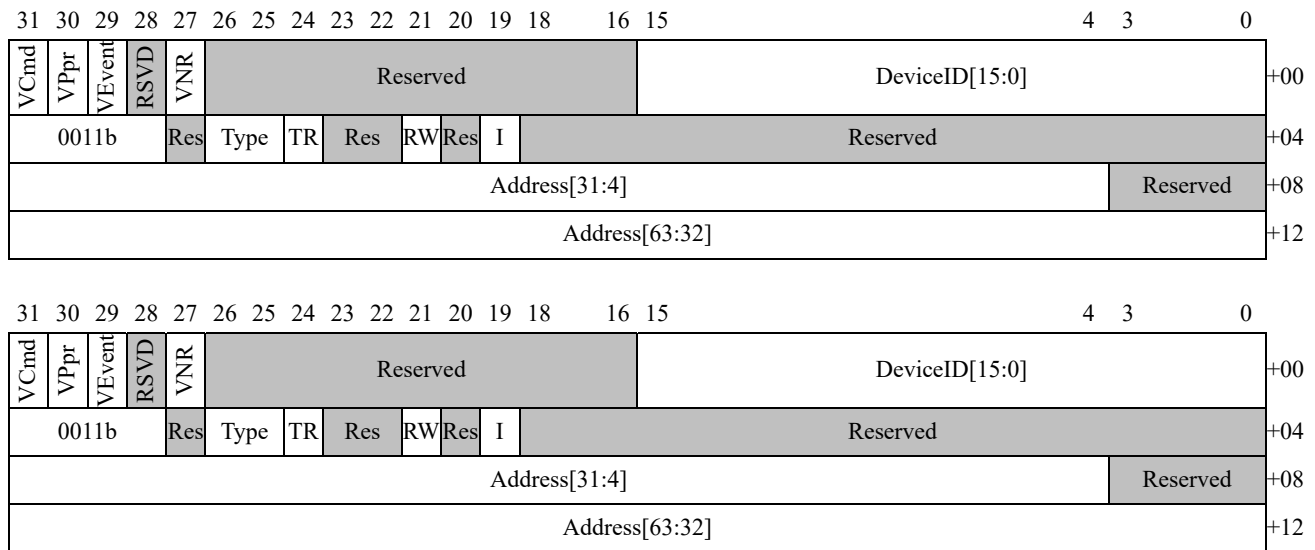

Figure 57: DEV_TAB_HARDWARE_ERROR Event Log Buffer Entry Format

Table 59: DEV_TAB_HARDWARE_ERROR Event Log Buffer Entry Fields

Bits	Description
31 +00	VCmd. Virtualized Command Buffer. This event occurs during processing of the virtualized command buffer. This bit is reserved and always 0 when vIOMMU feature is disabled.
30 +00	VPpr. Virtualized PPR Log. This event occurs during processing of the virtualized PPR log. This bit is reserved and always 0 when vIOMMU feature is disabled.
29 +00	VEvent. Virtualized Event Log. This event occurs during processing of the virtualized event log. This bit is reserved and always 0 when vIOMMU feature is disabled.
28 +00	Reserved
27 +00	VNR. vIOMMU Non-Recoverable. 0 = vIOMMU is fully operational. 1 = vIOMMU is corrupted and vIommu context need to be recreated. This bit is reserved and always 0 when vIOMMU feature is disabled.
26:16 +00	Reserved.
15:0 +00	DeviceID. Specifies the DeviceID that caused the Device Table lookup. The address of the Device Table entry can be determined using the DeviceID field.
31:28 +04	0011b. Specifies a DEV_TAB_HARDWARE_ERROR entry.

Table 59: DEV_TAB_HARDWARE_ERROR Event Log Buffer Entry Fields (Continued)

Bits	Description
27 +04	Reserved.
26:25 +04	Type. The Type field indicates the type of hardware error that occurred as listed in Table 58 .
24 +04	TR: translation. 1=transaction that caused the Device Table lookup was a translation request. 0=transaction that caused the Device Table lookup was a transaction request.
23:22 +04	Reserved.
21 +04	RW: read-write. 1=transaction was a write. 0=transaction was a read. RW is only meaningful when TR=0 and I=0.
20 +04	Reserved.
19 +04	I: interrupt. 1=transaction was an interrupt request. 0=transaction was a memory request.
18:0 +04	Reserved.
31:4 +08	Address[31:4]. The system physical address of the failed Device Table access. In this case the Address field does <i>not</i> contain the DVA the device was attempting to access.
3:0 +08	Reserved.
31:0 +12	Address[63:32]. The system physical address of the failed Device Table access. In this case the Address field does <i>not</i> contain the DVA the device was attempting to access.

2.5.5 PAGE_TAB_HARDWARE_ERROR Event

If the IOMMU detects a hardware error (master abort, target abort, poisoned data, etc.) while accessing the I/O page tables, the IOMMU writes the event log with a PAGE_TAB_HARDWARE_ERROR event (see [Table 46](#)). If the IOMMU detects a hardware error while accessing the guest CR3 table, the guest page tables, or the I/O page tables, the IOMMU writes the event log with a PAGE_TAB_HARDWARE_ERROR event (see [Table 46](#)). Data describing the PAGE_TAB_HARDWARE_ERROR event is also written to the hardware error registers (see in [Section 2.5.16.2 \[I/O Hardware Event Reporting Registers\]](#)).

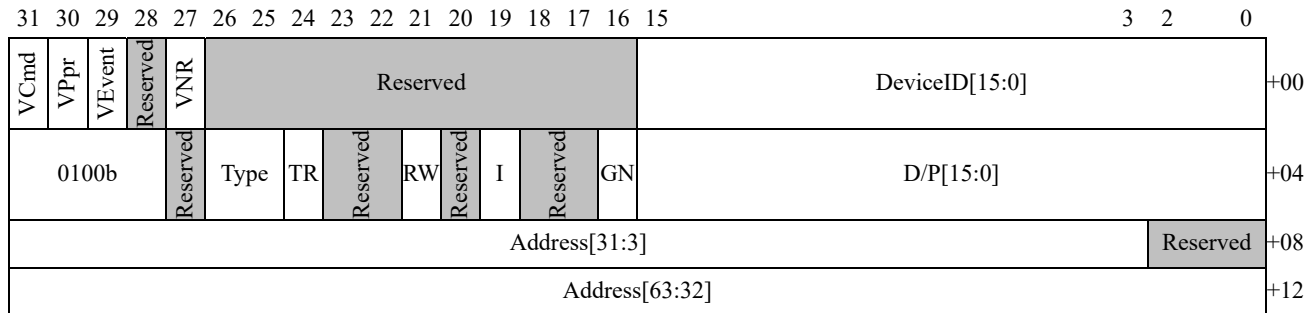

Figure 58: PAGE_TAB_HARDWARE_ERROR Event Log Buffer Entry Format

Table 60: PAGE_TAB_HARDWARE_ERROR Event Log Buffer Entry Fields

Bits	Description
31 +00	VCmd. Virtualized Command Buffer. This event occurs during processing of the virtualized command buffer. This bit is reserved and always 0 when vIOMMU feature is disabled.
30 +00	VPpr. Virtualized PPR Log. This event occurs during processing of the virtualized PPR log. This bit is reserved and always 0 when vIOMMU feature is disabled.
29 +00	VEvent. Virtualized Event Log. This event occurs during processing of the virtualized event log. This bit is reserved and always 0 when vIOMMU feature is disabled.
28 +00	Reserved.
27 +00	VNR. vIOMMU Non-Recoverable. 0 - vIOMMU is fully operational. 1 - vIOMMU is corrupted and vIommu context need to be recreated. This bit is reserved and always 0 when vIOMMU feature is disabled.
26:16 +00	Reserved.
15:0 +00	DeviceID. Specifies the DeviceID that caused the page table lookup. The address of the Device Table entry can be determined using the DeviceID field.
31:28 +04	0100b. Specifies a PAGE_TAB_HARDWARE_ERROR entry.
27 +04	Reserved.
26:25 +04	Type. The Type field indicates the type of hardware error that occurred as listed in Table 58.
24 +04	TR: translation. 1=transaction that caused the page table lookup was a translation request. 0=transaction that caused the page table lookup was an untranslated request.
23:22 +04	Reserved.

Table 60: PAGE_TAB_HARDWARE_ERROR Event Log Buffer Entry Fields(Continued)

Bits	Description
21 +04	RW: read-write. 1=transaction was a write. 0=transaction was a read. RW is only meaningful when TR=0 and I=0.
20 +04	Reserved.
19 +04	I: interrupt. 1=transaction was an interrupt request. 0=transaction was a memory request.
18:17 +04	Reserved.
16 +04	GN: guest/nested. 0=The address being translated by the IOMMU is an SPA. 1=The address being translated by the IOMMU is a GPA. Must be zero when MMIO Offset 0030h [GTSup]=0. <i>Software Note: when GN=1, the error could have been encountered in either the guest CR3 table or in the guest page tables.</i>
15:0 +04	D/P: DomainID/PASID. When guest translation / PASID is not supported, this field contains the DomainID of the peripheral that caused the page table lookup. When guest translation / PASID is supported, this field contains the PASID when GN=1; the DomainID when GN=0.
31:4 +08	Address[31:4]. The address of the page table entry.
3:0 +08	Reserved.
31:0 +12	Address[63:32]. The SPA of the page table entry. The original address space used by the peripheral is indicated by DeviceID, GN, and PASID. The Address field does <i>not</i> contain the address that the device attempted to access.

Software Note: When GN=1, the problem may be in the GCR3 table or in the guest page tables.

2.5.6 ILLEGAL_COMMAND_ERROR Event

If the IOMMU reads an invalid command (including an unsupported command code, or a command that incorrectly has reserved bits set), the IOMMU writes the event log with an ILLEGAL_COMMAND_ERROR event (see [Table 48](#)). The IOMMU must stop fetching new commands from the

command buffer if an `ILLEGAL_COMMAND_ERROR` event is detected.

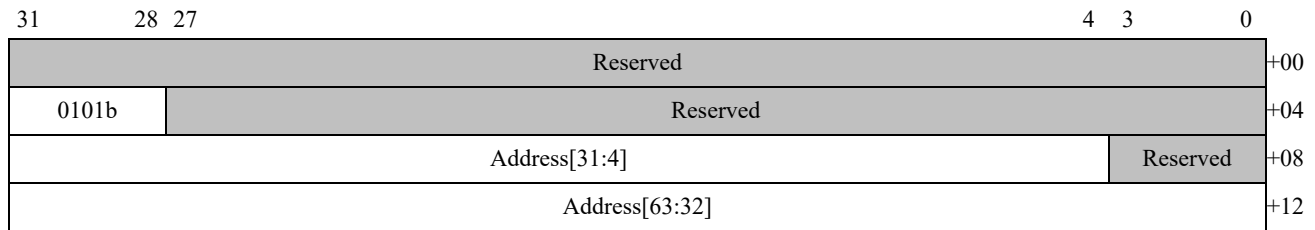

Figure 59: ILLEGAL_COMMAND_ERROR Event Log Buffer Entry Format

Table 61: ILLEGAL_COMMAND_ERROR Event Log Buffer Entry Fields

Bits	Description
31:0 +00	Reserved.
31:28 +04	0101b. Specifies an <code>ILLEGAL_COMMAND_ERROR</code> entry.
27:0 +04	Reserved.
31:4 +08	Address[31:4]. The system physical address of the invalid command.
3:0 +08	Reserved.
31:0 +12	Address[63:32]. The system physical address of the invalid command.

2.5.7 COMMAND_HARDWARE_ERROR Event

If the IOMMU detects a hardware error (master abort, target abort, poisoned data, etc.) while accessing the command buffer, the IOMMU writes the event log with a `COMMAND_HARDWARE_ERROR` event (see [Table 47](#)). The IOMMU must stop fetching new commands from the command buffer if a `COMMAND_HARDWARE_ERROR` event is detected.

Data describing the `COMMAND_HARDWARE_ERROR` event is also written to the hardware error registers (see [Section 2.5.16.2 \[I/O Hardware Event Reporting Registers\]](#)).

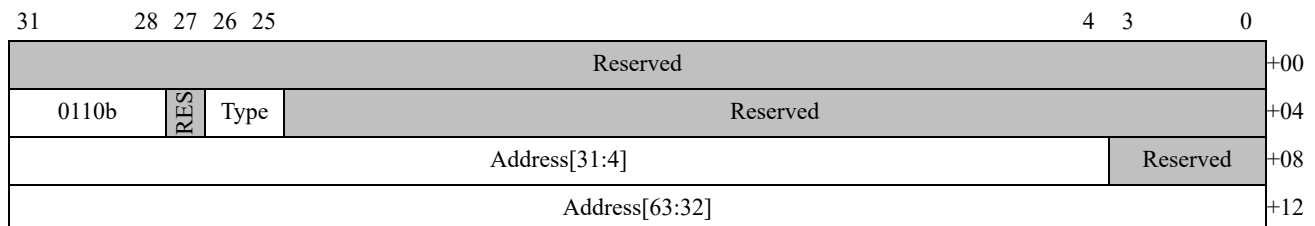

Figure 60: COMMAND_HARDWARE_ERROR Event Log Buffer Entry Format

Table 62: COMMAND_HARDWARE_ERROR Event Log Buffer Entry Fields

Bits	Description
31:0 +00	Reserved.
31:28 +04	0110b. Specifies a COMMAND_HARDWARE_ERROR entry.
27 +04	Reserved.
26:25 +04	Type. The Type field indicates the type of hardware event that occurred as listed in Table 58 .
24:0 +04	Reserved.
31:4 +08	Address[31:4]. The system physical address that the IOMMU attempted to access. This field is only valid if SR=0.
3:0 +08	Reserved.
31:0 +12	Address[63:32]. The system physical address that the IOMMU attempted to access. This field is only valid if SR=0.

2.5.8 IOTLB_INV_TIMEOUT Event

If the IOMMU sends an invalidation request to a device and does not receive a response before the invalidation timeout timer expires, the IOMMU writes the event log with a IOTLB_INV_TIMEOUT event (see [Table 49](#)). See special considerations in [Section 2.1.4.13 \[INVALIDATE_IOTLB_PAGES and Peripheral Reset\]](#).

The Address field contains the system physical address of the invalidation command that timed out.

**Figure 61: IOTLB_INV_TIMEOUT Event Log Buffer Entry Format**

Table 63: IOTLB_INV_TIMEOUT Event Log Buffer Entry Fields

Bits	Description
31:16 +00	Reserved.
15:0 +00	DeviceID. Specifies the DeviceID that caused the invalidation timeout. The identity of the device causing the error can be determined using the DeviceID field.
31:28 +04	0111b. Specifies a IOTLB_INV_TIMEOUT entry.
27:0 +04	Reserved.
31:4 +08	Address[31:4]. The system physical address of the invalidation command that timed out.
3:0 +08	Reserved.
31:0 +12	Address[63:32]. The system physical address of the invalidation command that timed out.

2.5.9 INVALID_DEVICE_REQUEST Event

If the IOMMU receives a request from a device that the device is not allowed to perform, the IOMMU writes the event log with a INVALID_DEVICE_REQUEST event (see [Table 50](#)). Creation of event log entries for INVALID_DEVICE_REQUEST events is controlled by the IG bit in the Device Table entry ([Figure 7](#) and [Table 7](#)). Depending on the type of the INVALID_DEVICE_REQUEST ([Table 64](#)), some of the fields in [Figure 62](#) and [Table 65](#) will not be meaningful.

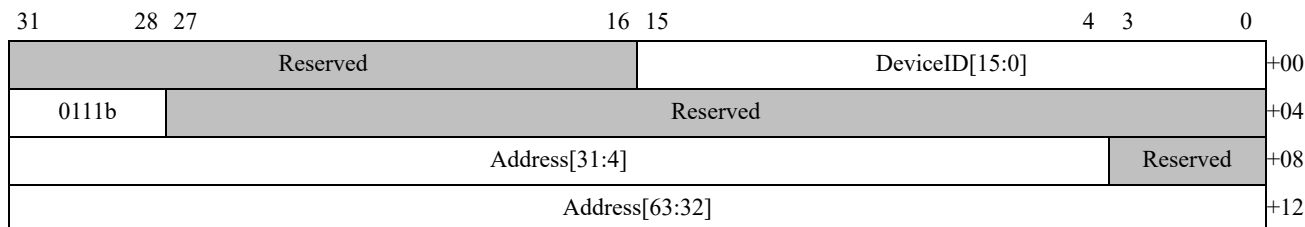
Table 64: INVALID_DEVICE_REQUEST Type Field Encodings

Type	TR	Description
000b	0b	Read request or non-posted write in the interrupt address range (see Table 3).
001b	0b	Pretranslated transaction received from an I/O device that has I=0 or V=0 in the device's DTE.
010b	0b	Port I/O space transaction received from an I/O device that has IoCtl=00b in the device's DTE.
011b	0b	Posted write to the system management address range received from an I/O device that has SysMgt=00b, or with SysMgt=10b and the message is not a INTx message in the device's DTE, or a posted write to the address translation range when HtAtsResv=1 (see Table 3).
100b	0b	When guest translation / PASID are not supported, read request or non-posted write in the system management address range (if SysMgt=10b or 0xb), or a read request or a non-posted write in the address translation range when HtAtsResv=1 (see Table 3); GN=1 for these errors and PASID is ignored. Also, a transaction in any address range with a TLP prefix when guest translation is not supported or not active for the I/O device (see Table 5); note that GN=1 for these errors and PASID is valid.

Table 64: INVALID_DEVICE_REQUEST Type Field Encodings (Continued)

Type	TR	Description
101b	0b	Posted write to the Interrupt/EOI range from an I/O device that has IntCtl=00b in the device's DTE (see Table 3).
110b	0b	Posted write to a reserved interrupt address range (see Table 3).
111b	0b	Transaction to the system management address range when SysMgt=11b or to the port I/O space range when IoCtl=10b, while V=1 and TV=0.
000b	1b	Translation request received from an I/O device that has I=0, or has V=0, or has V=1 and TV=0 in the device's DTE. This encoding is also used when a translation requests is received with a virtual address in the address translation range and HtAtsResv=1 to use encoding of Type=001b with TR=1b instead of Type=000b with TR=1b.
001b	1b	Translation request in the interrupt, port I/O space (if IoCtl=0xb), or system management address range (if SysMgt=0xb or 10b); or translation request in the system management address range when SysMgt=11b or in the port I/O space range when IoCtl=10b, while V=1 and TV=0.
010b	1b	When PASID is supported, a translation request for any address with a TLP prefix when guest translation is not supported or not active for the I/O device (see Table 5); note that GN=1 for these errors and PASID is valid.
011b-111b	1b	Reserved.

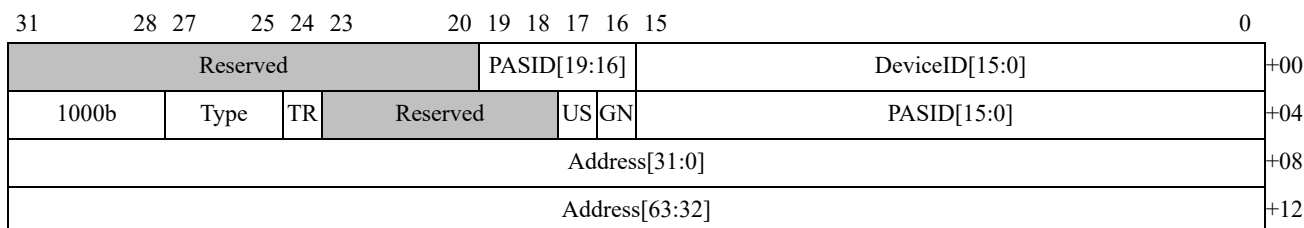
**Figure 62: INVALID_DEVICE_REQUEST Event Log Buffer Entry Format****Table 65: INVALID_DEVICE_REQUEST Event Log Buffer Entry Fields**

Bits	Description
31:16 +00	PASID[19:16] : process address space ID. When guest translation / PASID feature is supported, this field contains PASID[19:16] when GN=1; 0h when GN=0.
15:0 +00	DeviceID . Specifies the DeviceID that caused the page table lookup. The address of the Device Table entry can be determined using the DeviceID field.
31:28 +04	1000b . Specifies an INVALID_DEVICE_REQUEST entry.
27:25 +04	Type . The Type field indicates the type of hardware event that occurred as listed in Table 64.
24 +04	TR: translation . 1=transaction that caused the page table lookup was a translation request. 0=transaction that caused the page table lookup was a transaction request. See Table 64.

Table 65: INVALID_DEVICE_REQUEST Event Log Buffer Entry Fields (Continued)

Bits	Description
23:18 +04	Reserved.
17	US: user-supervisor. 0=Supervisor privileges were asserted. 1=User privileges were asserted.
16 +04	GN: guest/nested. 0=Address is a GPA. 1=Address is a GVA.
15:0 +04	PASID[15:0]: Process address space ID. The PASID when GN=1; 0000h when GN=0.
31:0 +08	Address[31:0]. The address that the device attempted to translate or access. See GN.
31:0 +12	Address[63:32]. The address that the device attempted to translate or access. See GN.

2.5.10 INVALID_PPR_REQUEST Event

When supported, an INVALID_PPR_REQUEST event log entry is generated when the peripheral page request or the completion command has a problem (see Table 52).

When Capability Offset 00h[EFRSup]=0 or MMIO Offset 0030h[PPRSup]=0, the PCIe page request interface (PRI) is not supported by an IOMMU implementation and a COMPLETE_PPR_REQUEST command will cause an ILLEGAL_COMMAND_ERROR event. When PRI is supported (MMIO Offset 0030h[PPRSup]=1), a PRI request from a peripheral is invalid when MMIO Offset 0018h[PPREn]=0 or MMIO Offset 0018h[PPRLogEn]=0. An individual peripheral is not enabled for PRI when Capability Offset 0030h[EPHSup]=1 and DTE[PPR]=0.

When the IOMMU receives an invalid PPR request from a peripheral, it writes the event log with an INVALID_PPR_REQUEST event containing RX=0. For certain error conditions noted in Table 52, the IOMMU also target aborts the transaction. The IOMMU continues processing normally. Software is responsible to issue any COMPLETE_PPR_REQUEST command required by the peripheral. The values in the INVALID_PPR_REQUEST event log entry are obtained from the peripheral page request when RX=0.

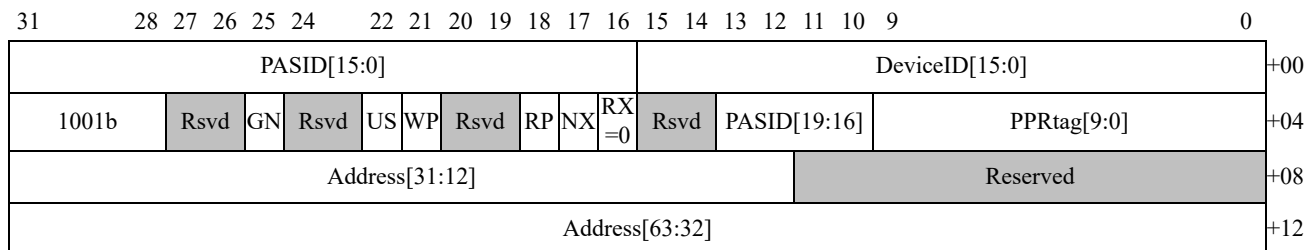

Figure 63: INVALID_PPR_REQUEST Event Log Buffer Entry Format, RX = 0

When the IOMMU detects an error while processing a COMPLETE_PPR_REQUEST command, the IOMMU writes the event log with an INVALID_PPR_REQUEST event containing RX = 1. The

DeviceID and PPRtag fields are extracted from the failed COMPLETE_PPR_REQUEST command and the address of the COMPLETE_PPR_REQUEST command is reported in Address[63:0]. When RX = 1, the contents of the WP, RP, and NX fields are undefined and should be ignored by software.

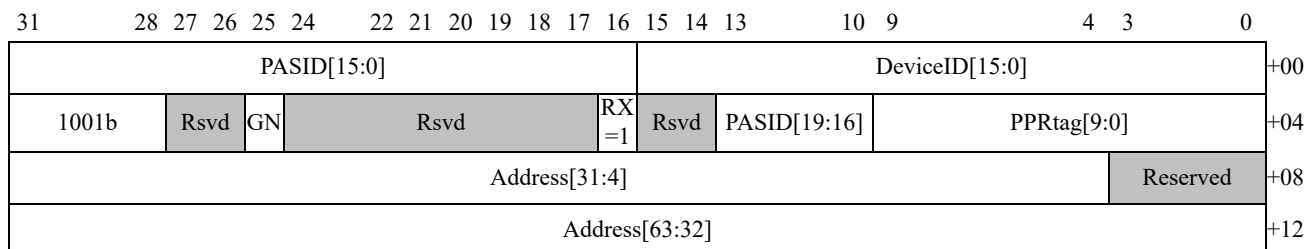

Figure 64: INVALID_PPR_REQUEST Event Log Buffer Entry Format, RX = 1

Table 66: INVALID_PPR_REQUEST Event Log Buffer Entry Fields

Bits	Description, RX=0	Description, RX=1
31:16 +00	PASID[15:0] . Meaningful if GN=1; must be zero if GN=0.	
15:0 +00	DeviceID[15:0] . DeviceID of the peripheral issuing the invalid PPR request.	DeviceID[15:0] . DeviceID of the target peripheral (see Section 2.4.7 [COMPLETE_PPR_REQUEST]).
31:28 +04	1001b . Specifies an INVALID_PPR_REQUEST entry.	
27:26 +04	Reserved.	
25 +04	GN: guest/nested . 0=Address is a GPA and PASID is not meaningful. 1=Address is a GVA and PASID contains the process address space ID.	
24:23 +04	Reserved	
22 +04	US . User/supervisor bit as received from the peripheral. See PMR in Table 33 .	Reserved.
21 +04	WP . Write permission request bit as received from the peripheral.	Reserved.
20:19 +04	Reserved.	
18 +04	RP . Read permission request bit as received from the peripheral.	Reserved.
17 +04	NX . No-execute permission request bit as received from the peripheral. See Exe in Table 33	Reserved.
16 +04	RX . 0=Invalid PAGE_SERVICE_REQUEST received (see Section 2.6.3 [Peripheral Page Request Entry]).	RX . 1=COMPLETE_PPR_REQUEST failed (see Section 2.4.7 [COMPLETE_PPR_REQUEST]).

Table 66: INVALID_PPR_REQUEST Event Log Buffer Entry Fields (Continued)

Bits	Description, RX=0	Description, RX=1
15:14 +04	Reserved.	
13:10 +04	PASID[19:16] . Meaningful if GN=1; must be zero if GN=0.	
9:0 +04	PPRtag[9:0] . The PPRtag field as received from the peripheral. This field contains a protocol-dependent tag. When the PPR request originated as a PCIe page request message, PPRtag[9] is the L bit and PPRtag[8:0] is the PRG index.	PPRtag[9:0] . The PPRtag field as sent to the peripheral. This field contains a protocol-dependent tag. When the PPR completion targets a PCIe peripheral, PPRtag[9] is the L bit and PPRtag[8:0] is the PRG index. The PRI Response Code in is not reported (see Table 40).
31:12 +08	Address[31:12] . The page address as received from the peripheral.	Address[31:4] . The SPA of the invalid PPR completion command.
11:4 +08	Reserved.	
3:0 +08	Reserved.	
31:0 +12	Address[63:32] . The page address as received from the peripheral.	Address[63:32] . The SPA of the invalid PPR completion command.

Software Note: Software is responsible to take the PCI PRG index from the PPRtag field and use it in the PPR completion command (see Section 2.4.7 [COMPLETE_PPR_REQUEST]).

2.5.11 EVENT_COUNTER_ZERO Event

When the IOMMU is programmed to count events and a counter increments to become equal to zero, the IOMMU generates an EVENT_COUNTER_ZERO event. The CounterNote field contains the CounterNote value programmed into the corresponding event register (see IOMMU Counter Report Register [MMIO Offset [40-7F][0-F]28h]). The EVENT_COUNTER_ZERO event log entry is managed by the same controls as other events (see MMIO Offset 0010h[MsiNum] and MMIO Offset 0018h[EventIntEn, EventLogEn]).

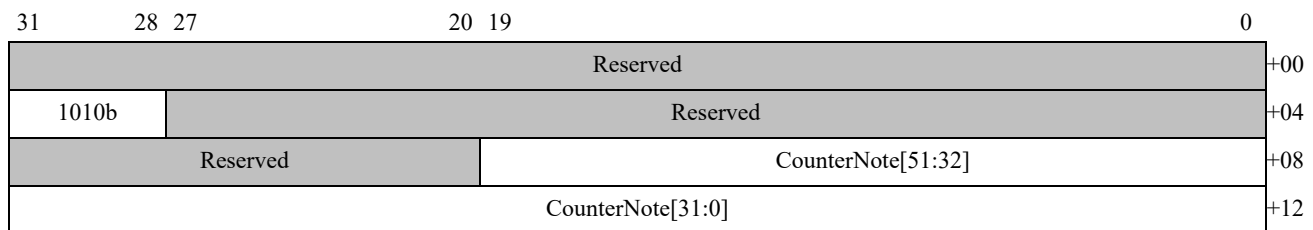

Figure 65: EVENT_COUNTER_ZERO Event Log Buffer Entry Format

Table 67: EVENT_COUNTER_ZERO Event Log Buffer Entry Fields

Bits	Description
31:00 +00	Reserved.
31:28 +04	1010b . Specifies a EVENT_COUNTER_ZERO entry.
27:0 +04	Reserved.
31:20 +08	Reserved.
19:0 +08	CounterNote[51:0] . The CounterNote value programmed into the corresponding Event Counter Register (see IOMMU Counter Report Register [MMIO Offset [40-7F][0-F]28h]).
31:0 +12	

2.5.12 GUEST_EVENT_FAULT Event

When INSERT_GUEST_EVENT is supported, IOMMU generates a GUEST_EVENT_FAULT event when the reserved bits in the INSERT_GUEST_EVENT command are not zero. GUEST_EVENT_FAULT event is always written in pairs with a guest event entry immediately after it into the event log, which takes up two event log entries. The guest event entry is taken from the original guest event which pair with the INSERT_GUEST_EVENT.

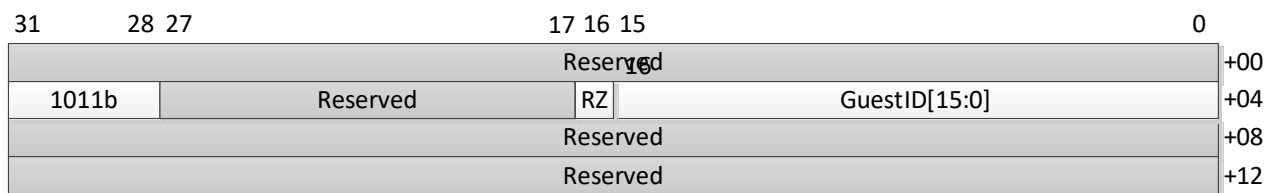
**Figure 66: GUEST_EVENT_FAULT Event Buffer Entry Format****Table 68: Guest_Event_Fault Event Log Buffer Entry Fields**

Bits	Description
31:0 +00	Reserved.
31:28 +04	1011b . Specifies a GUEST_EVENT_FAULT entry.
27:17 +04	Reserved.

Table 68: Guest_Event_Fault Event Log Buffer Entry Fields (Continued)

Bits	Description
16: +04	RZ. Reserved bits not zero. 1=This event is caused by a non-zero reserved bit in the INSERT_GUEST_EVENT command.
15:0 +04	GuestID. The 16 bit value which the host software assign to the guest.
31:0 +08	Reserved.
31:0 +12	Reserved.

2.5.13 VIOMMU_HARDWARE_ERROR Event

If the IOMMU detects a hardware error (master abort, target abort, poisoned data, etc) while accessing its private memory, the IOMMU writes the event log with a VIOMMU_HARDWARE_ERROR event.

SW Note: When the vIOMMU faults, HV can communicate to Guest via other channel, OR, HV may utilize the VIOMMU_HARDWARE_ERROR command to communicate to the guest which part of vIOMMU is not working properly by inject the command into the guest event log. Src, GuestID, Type, RW fields should be treated as reserved when a VIOMMU_HARDWARE_ERROR command is injected into the guest.

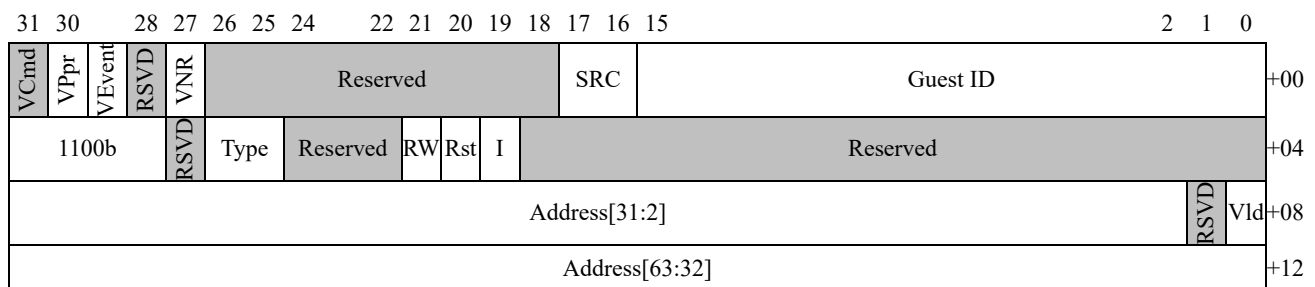

Figure 67: VIOMMU_HARDWARE_ERROR Event Entry Format

Table 69: VIOMMU_HARDWARE_ERROR Event Entry Fields

Bits	Description
31 +00	VCmd. Virtualized Command Buffer. This event occurs during processing of the virtualized command buffer. This bit is reserved and always 0 when vIOMMU feature is disabled.
30 +00	VPpr. Virtualized PPR Log. This event occurs during processing of the virtualized PPR log. This bit is reserved and always 0 when vIOMMU feature is disabled.
29 +00	VEvent. Virtualized Event Log. This event occurs during processing of the virtualized event log. This bit is reserved and always 0 when vIOMMU feature is disabled.
28 +00	Reserved.

Table 69: VIOMMU_HARDWARE_ERROR Event Entry Fields (Continued)

Bits	Description
27 +00	VNR. vIOMMU Non-Recoverable. 0= vIOMMU is fully operational. 1= vIOMMU is corrupted and vIommu context need to be recreated. This bit is reserved and always 0 when vIOMMU feature is disabled.
26:18 +00	Reserved.
17:16 +00	Src. Source. 00 – an hardware error is detected while accessing the vIOMMU MMIO registers 01 – an hardware error is detected while accessing the DeviceID Table 10 – an hardware error is detected while accessing the DomainID Table 11 – an hardware error is detected while accessing other IOMMU Private Memory.
15:0 +00	GuestID. the 16 bit value which the host software assign to the guest.
31:28 +04	I100b. Specifies a VIOMMU_HARDWARE_ERROR entry.
26:25 +04	Type. The Type field indicates the type of hardware error that occurred as listed in Table 51 .
24:22 +04	Reserved.
21 +04	RW. read-write. 1=transaction was a write. 0=transaction was a read. RW is only meaningful I=0.
20 +04	Rst. 1 – this hardware error is occur during processing a RESET_VMMIO Command from the host command buffer log.
19 +04	I. interrupt. 1=transaction was an interrupt request. 0=transaction was a memory request.
18:0 +04	Reserved.
31:2 +08	Address[31:2]. The system physical address accessed by vIOMMU hardware.
1 +08	Reserved.
0 +08	Vld. Valid Address. 1 - Address[63:2] field is being used in the event and the content is valid. 0 - The Address[63:2] field is not being used in the event.
31:0 +12	Address[63:32]. The system physical address accessed by vIOMMU hardware.

2.5.14 RMP_PAGE_FAULT Event

In an SNP-enabled system, the IOMMU reads the RMP table to perform addition security checks. If the IOMMU encounters an error condition as part of doing the RMP checks, the IOMMU writes the event log with an RMP_PAGE_FAULT event.

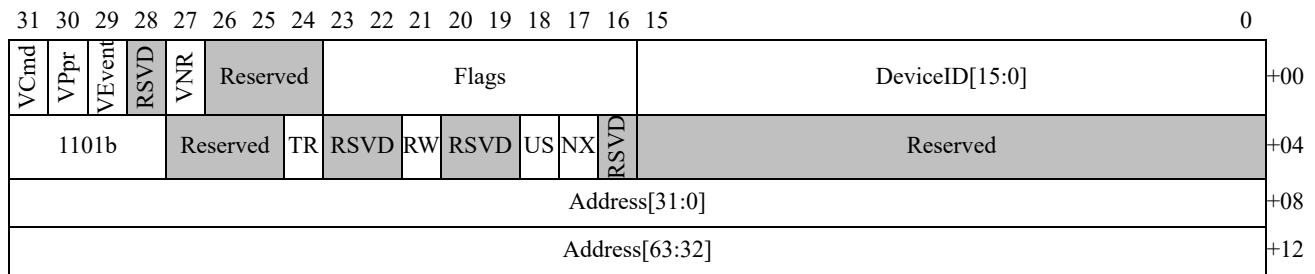

Figure 68: RMP_PAGE_FAULT Event Log Buffer Entry Format

Table 70: RMP_PAGE_FAULT Event Log Buffer Entry Fields

Bits	Description
31 +00	VCmd. Virtualized Command Buffer. This event occurs during processing of the virtualized command buffer. This bit is reserved when the vIOMMU feature is disabled.
30 +00	VPpr. Virtualized PPR Log. This event occurs during processing of the virtualized PPR log. This bit is reserved when the vIOMMU feature is disabled.
29 +00	VEvent. Virtualized Event Log. This event occurs during processing of the virtualized event log. This bit is reserved when the vIOMMU feature is disabled.
28 +00	Reserved
27 +00	VNR. vIOMMU Non-Recoverable. 0= vIOMMU is fully operational. 1= vIOMMU is corrupted and vIOMMU context must be recreated. This bit is reserved and always 0 when vIOMMU feature is disabled.
26:24 +00	Reserved
23:16 +00	Flags: One-hot indicator of all the RMP checks that failed. Flags[7] = Reserved Flags[6] = Reserved Flags[5] = PAGE_IMMUTABLE Flags[4] = Reserved Flags[3] = PAGE_LOCKED Flags[2] = PAGE_SIZE_MISMATCH Flags[1] = ASID_MISMATCH Flags[0] = Reserved
15:0 +00	DeviceID. Specifies the DeviceID of the request that caused the RMP lookup.
31:28 +04	1101b. Specifies an RMP_PAGE_FAULT entry.
27:25 +04	Reserved

Table 70: RMP_PAGE_FAULT Event Log Buffer Entry Fields (Continued)

Bits	Description
24 +04	TR: translation. 1=Transaction that caused the RMP lookup was a translation request. 0=Transaction that caused the RMP lookup was a transaction request.
23:22 +04	Reserved
21 +04	RW: read-write. 1=Transaction was a write. 0=transaction was a read. RW is only meaningful when TR=0.
20 +04	Reserved
19 +04	Reserved
18 +04	US: user-supervisor. 0=Supervisor privileges were asserted. 1=User privileges were asserted.
17 +04	NX: no execute. NX bit as requested by peripheral when the upstream transaction has a PASID TLP prefix; 0 when the upstream transaction lacks a PASID TLP prefix.
16 +04	Reserved
15:0 +04	Reserved
31:0 +08	Address[31:0]. The Guest Physical address of the memory access that failed the RMP check.
31:0 +12	Address[63:32]. The Guest Physical address of the memory access that failed the RMP check.

2.5.15 RMP_HARDWARE_ERROR Event

In an SNP-enabled system, if the IOMMU detects a hardware error (master abort, target abort, poisoned data, etc.) while accessing the RMP, the IOMMU writes an event log entry with RMP_HARDWARE_ERROR event. See [Figure 69](#).

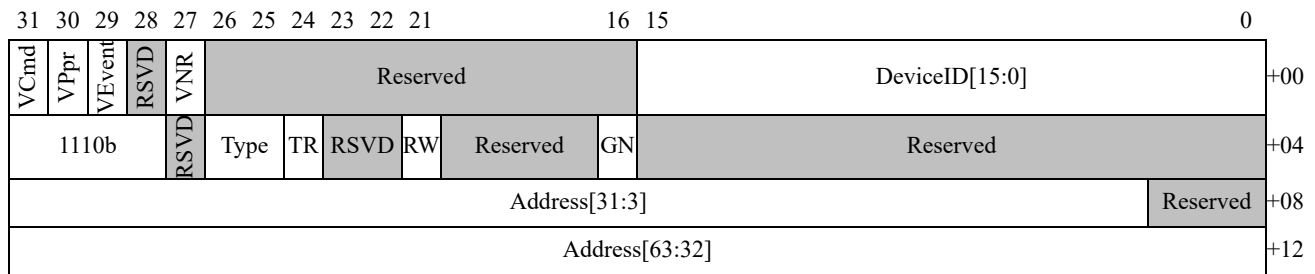

Figure 69: RMP_HARDWARE_ERROR Event Log Buffer Entry Format

Table 71: RMP_HARDWARE_ERROR Event Log Buffer Entry Fields

Bits	Description
31 +00	VCmd. Virtualized Command Buffer. This event occurs during processing of the virtualized command buffer. This bit is reserved when the vIOMMU feature is disabled.
30 +00	VPr. Virtualized PPR Log. This event occurs during processing of the virtualized PPR log. This bit is reserved when the vIOMMU feature is disabled.
29 +00	VEvent. Virtualized Event Log. This event occurs during processing of the virtualized event log. This bit is reserved when the vIOMMU feature is disabled.
28 +00	Reserved
27 +00	VNR. vIOMMU Non-Recoverable. 0= vIOMMU is fully operational. 1= vIOMMU is corrupted and vIOMMU context need to be recreated. This bit is reserved when the vIOMMU feature is disabled.
26:16 +00	Reserved
15:0 +00	DeviceID. Specifies the DeviceID of the request that caused the RMP lookup.
31:28 +04	1110b. Specifies an RMP_HARDWARE_ERROR entry.
27 +04	Reserved
26:25 +04	Type. Indicates the type of hardware error that occurred as listed in Table 58 on page 151 .
24 +04	TR: translation. 1=Transaction that caused the RMP lookup was a translation request. 0=Transaction that caused the RMP lookup was a transaction request.
23:22 +04	Reserved
21 +04	RW: read-write. 1=Transaction was a write. 0=Transaction was a read. RW is only meaningful when TR=0

Table 71: RMP_HARDWARE_ERROR Event Log Buffer Entry Fields (Continued)

Bits	Description
20:17 +04	Reserved
16 +04	GN: guest/nested. 0=Transaction contained a GPA. 1=Transaction contained a GVA. Must be zero when MMIO Offset 0030h[GTSup]=0. Software Note: When GN=1, the error could have been encountered in either the guest CR3 table or in the guest page tables.
15:0 +04	Reserved
31:3 +08	Address[31:3]. The system physical address of the failed RMP access.
2:0 +08	Reserved
31:0 +12	Address[63:32]. The system physical address of the failed RMP access.

2.5.16 IOMMU Event Reporting

The IOMMU is designed to identify and report hardware events, software programming problems, completion events, and performance events. Hardware events are the highest priority, programming problems are reported when there are no hardware events detected, and completion and performance events are reported as soon as possible. The IOMMU reports one event for a given activity; because the IOMMU can be highly concurrent, multiple events may be reported in quick succession from different causes. The IOMMU checks for exceptions in a sequence designed to protect system integrity and described in [Section 2.5.16.1 \[IOMMU Data Validation Sequence\]](#).

Hardware events could prevent reporting events via the event log in memory and are reported in IOMMU registers ([Section 2.5.16.2 \[I/O Hardware Event Reporting Registers\]](#)).

2.5.16.1 IOMMU Data Validation Sequence

When the IOMMU processes an interrupt remapping or address translation operation, it follows the data validation sequence in [Figure 65](#). The order of reported events can vary based on the nature of the events and cached information. In the case of multiple events, the IOMMU is only required to report a single event.

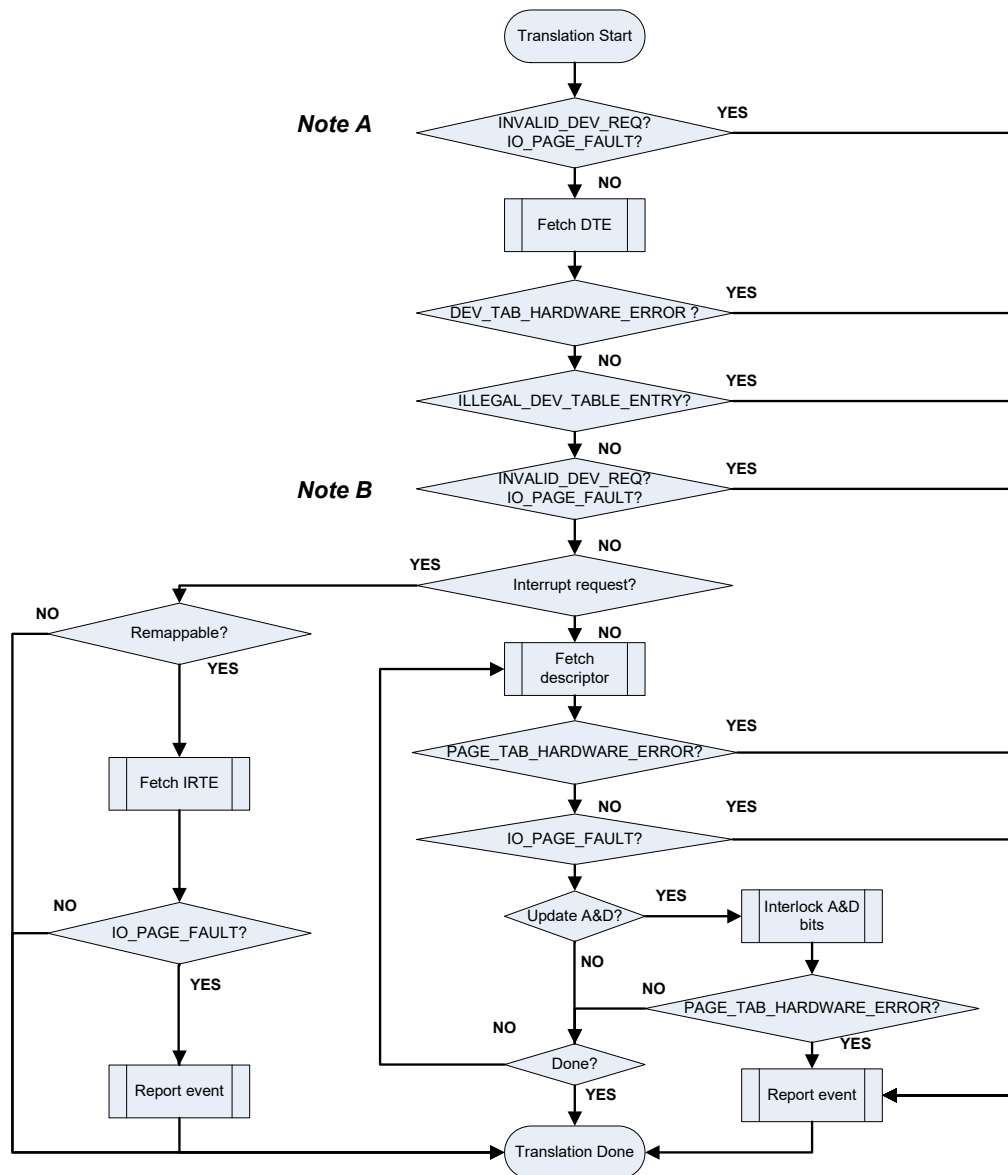

Figure 70: Translation and Remapping Validation Sequence

- **Note A:** These checks may run in parallel and an implementation selects any event to report when it detects multiple events.
- **Note B:** INVALID_DEVICE_REQUEST and IO_PAGE_FAULT checks may run in parallel and an implementation selects any detected event to report when it identifies multiple errors.

The IOMMU initially uses architectural definitions and information programmed in the registers to validate the request (Table 3, Device Table Base Address Register [MMIO Offset 0000h], IOMMU Control Register [MMIO Offset 0018h], IOMMU Exclusion Base Register / Completion Store Base Register [MMIO Offset 0020h], IOMMU Exclusion Range Limit Register / Completion Store Limit Register [MMIO Offset 0028h], and IOMMU Extended Feature Register [MMIO Offset 0030h]).

Once the IOMMU has loaded a Device Table entry, it runs a series of checks. The IOMMU uses architectural definitions to determine if the request requires interrupt remapping or address translation (Table 3). For interrupt remapping, the DTE and IRTE are used with architectural definitions to check for exceptions in sequence (Table 9 and Table 10). For address translation, the IOMMU fetches a series of descriptors and checks for exceptions in sequence. After reporting an event, the IOMMU terminates the translation process.

2.5.16.2 I/O Hardware Event Reporting Registers

Three types of event log entries are caused by memory faults:

- Section 2.5.4 [DEV_TAB_HARDWARE_ERROR Event],
- Section 2.5.5 [PAGE_TAB_HARDWARE_ERROR Event], and
- Section 2.5.7 [COMMAND_HARDWARE_ERROR Event].

When hardware event reporting is supported, hardware event information is written to the hardware event registers by the IOMMU if MMIO Offset 0030h[HESup]=1. The event log information shown in Figure 54 for the hardware events listed in this section is reported in IOMMU Hardware Event Upper Register [MMIO Offset 0040h] and IOMMU Hardware Event Lower Register [MMIO Offset 0048h] where it can be extracted (e.g., for system diagnostic purposes when memory issues prevent updates to the event log). When logging is enabled, the IOMMU also creates an event log entry.

When MMIO Offset 0018h[EventIntEn]=1, the IOMMU signals an interrupt. The hardware events are reported in the hardware event registers even when event logging to memory is not enabled. The information in the hardware event registers is meaningful when MMIO Offset 0050h[HEV]=1. The information in the hardware event registers has overwritten prior information when MMIO Offset 0050h[HEO]=1. Hardware sets MMIO Offset 0050h[HEO]=1 if MMIO Offset 0050h[HEV]=1 when the IOMMU writes new information to IOMMU Hardware Event Upper Register [MMIO Offset 0040h] and IOMMU Hardware Event Lower Register [MMIO Offset 0048h]. HEO is informational and event register overflow does not, itself, cause an error. Software must clear HEV after reading the hardware event registers to prepare the registers to record new information.

2.5.17 Event Log Dual Buffering

The optional Event Log dual buffering feature is designed to reduce the likelihood of Event Log overflow by allowing system software to set up an alternate buffer space for Event logging. When one log fills, Event entries spill over to a second buffer area.

Support for the Event Log dual buffering feature is indicated by MMIO Offset 0030h[DualEventLogSup] > 0. When the dual log feature is supported, the base Event Log buffer is also referred to as Event Log A.

The DualEventLogSup field encodes three levels of capability:

Table 72: DualEventLogSup Field Capability Levels

DualEventLogSup	Capability
00b	Dual buffering not supported
01b	Dual buffer support; no auto swap
10b	Dual buffer with auto swap supported

Table 72: DualEventLogSup Field Capability Levels (Continued)

DualEventLogSup	Capability
11b	<i>Reserved.</i>

The Event log dual buffer feature is enabled by setting [MMIO Offset 0018h](#)[DualEventLogEn] to a non-zero value. This 2-bit field encodes three levels of operation:

Table 73: DualEventLogEn Field Operation Levels

DualEventLogEn	Operation
00b	Event logging uses buffer A exclusively.
01b	Event logging uses buffer B exclusively.
10b	Automatically swap buffers when one becomes full.
11b	<i>Reserved.</i>

It is an error to set DualEventLogEn to 10b if the IOMMU does not support autoswap.

The dual event log buffer feature defines three registers that allows system software to set up and manage an alternate Event Log (Log B). These are:

- [Event Log B Base Address Register](#) [MMIO Offset 00F8h]
- [Event Log B Head Pointer Register](#) [MMIO Offset 2070h]
- [Event Log B Tail Pointer Register](#) [MMIO Offset 2078h]

See individual register definitions for information on the format of these registers.

Fields in the [IOMMU Status Register](#) [MMIO Offset 2020h] provide real-time information about both logs. The EventLogActive field indicates which log is currently being filled. EventOvrflwB is set by hardware when Log B overflows.

When auto swap is supported and enabled, logging behavior is modified:

When event logging is enabled, events are logged in Log A.

If Log A is active, an event occurs, there is no room in Log A to log the event, and Log B overflow bit is not set, the log entry is added to Log B at the entry pointed by the Event Log B Tail pointer. Log A overflow is set.

If Log B is active, an event occurs, there is no room in Log B to log the event, and Log A overflow bit is not set, the log entry is added to Log A at the entry pointed by the Event Log Tail pointer. Log B overflow is set.

Note: If the overflow bit of the log to be swapped to is set when a log swap is about to occur, an error is logged.

2.6 Peripheral Page Request (PPR) Logging

Some ATS-capable peripherals can issue requests to the processor to service peripheral page requests using PCIe PRI, the Page Request Interface (see the [PCI Address Translation Services Revision 1.1](#) specification). An IOMMU that supports peripheral page requests ([MMIO Offset 0030h](#)[PPR-

Sup]=1b) can report these requests to the host software by means of a shared circular buffer in system memory. The IOMMU writes peripheral page request (PPR) records into the buffer when enabled by [MMIO Offset 0018h\[PPREn\]](#). The host software increments the IOMMU's PPR request log head pointer to indicate to the IOMMU that it has consumed PPR request log entries. When software has completed processing the PPR request, it uses the IOMMU COMPLETE_PPR_REQUEST command to inform the peripheral of the results (see [Section 2.4.7 \[COMPLETE_PPR_REQUEST\]](#)).

Software Note: The IOMMU cannot service PRI requests without software intervention, so it converts them to PPR log entries for software to process. All PRI requests are converted to PPR log entries as long as there is room in the PPR log while [MMIO Offset 0018h\[PPRLogEn\]](#) = 1. To stop the IOMMU from processing all PRI requests, software can program [MMIO Offset 0018h\[PPRLogEn\]](#) = 0; this causes PRI requests to be discarded by the IOMMU. To stop an individual peripheral from issuing PRI requests, software must use control fields in the peripheral registers.

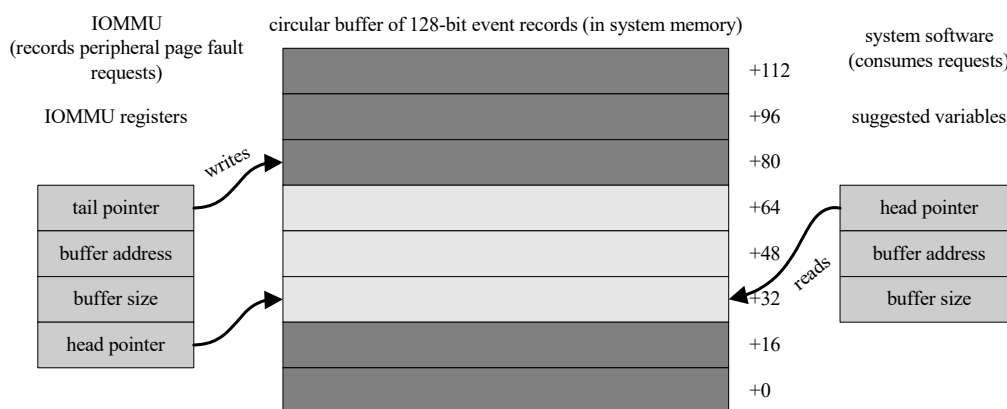

Figure 71: Peripheral Page Request Log in System Memory

The [PPR Log Base Address Register \[MMIO Offset 0038h\]](#) is used to program the system physical address and size of the PPR log. The PPR log occupies contiguous physical memory starting at the programmed base address up to the programmed size. The size of the PPR log must be a multiple of 4 Kbytes (to facilitate “modulo N” indexing for circularity) and can be as large as 32768 entries (corresponding to a 512 kilobyte buffer). The base address of the PPR log must be aligned to a multiple of 4 Kbytes.

In addition to the [PPR Log Base Address Register \[MMIO Offset 0038h\]](#), the IOMMU maintains two other registers associated with the PPR log: the [IOMMU PPR Log Head Pointer Register \[MMIO Offset 2030h\]](#), which points to the next PPR request that software will read, and the [IOMMU PPR Log Tail Pointer Register \[MMIO Offset 2038h\]](#), which points to the next PPR request to be written by the IOMMU. These registers are located in MMIO space.

When the [PPR Log Base Address Register \[MMIO Offset 0038h\]](#) register is written, the [IOMMU PPR Log Head Pointer Register \[MMIO Offset 2030h\]](#) and the [IOMMU PPR Log Tail Pointer Register \[MMIO Offset 2038h\]](#) are cleared to 0. When the [IOMMU PPR Log Head Pointer Register \[MMIO Offset 2030h\]](#) and the [IOMMU PPR Log Tail Pointer Register \[MMIO Offset 2038h\]](#) are equal, the PPR request log is empty. The [IOMMU PPR Log Tail Pointer Register \[MMIO Offset 2038h\]](#) is incremented by the IOMMU after writing a PPR request to the log. If the IOMMU needs to

report a service request but finds that the PPR log is already full, it sets **MMIO Offset 2020h**[PprOverflow].

The IOMMU can be configured to signal an MSI interrupt by programming the **Capability Offset 10h**[MsiNumPPR]. When enabled by setting **MMIO Offset 0018h**[PprIntEn], the IOMMU can be programmed to signal an interrupt whenever the PPR log is written or overflows. The PPR request log is full when all slots but one are used. The PPR log has overflowed when a PPR request occurs that is to be logged and would otherwise consume the last unused slot. When the PPR log has overflowed, the **MMIO Offset 2020h**[PprOverflow] is set, any data for new PPR requests is discarded, and PPR logging is disabled. The host software must make space in the PPR log by reading entries (by adjusting the head pointer) or resizing the log. PPR request logging may then be restarted.

The PPR Log dual buffering feature described in the next section adds support for a second PPR Log.

2.6.1 PPR Log Dual Buffering

The optional PPR Log dual buffering feature is designed to reduce the likelihood of PPR Log overflow by allowing system software to set up an alternate buffer space for PPR logging. When one log fills, PPR entries spill over to a second buffer area. Buffers can be managed as ping-pong buffers using two fixed areas of memory, or a longer series of buffers can be maintained by allowing two active buffers to leap-frog one another.

Support for the PPR Log dual buffering feature is indicated by **MMIO Offset 0030h**[DualPprLogSup] > 0. When the dual log feature is supported, the base PPR log buffer is also referred to as PPR Log A.

The DualPprLogSup field encodes three levels of capability:

DualPprLogSup	Capability
00b	Dual buffering not supported
01b	Dual buffer support; no auto swap
10b	Dual buffer with auto swap supported
11b	<i>Reserved.</i>

The PPR log dual buffer feature is enabled by setting **MMIO Offset 0018h**[DualPprLogEn] to a non-zero value. This 2-bit field encodes three levels of operation:

DualPprLogEn	Operation
00b	PPR logging uses buffer A exclusively.
01b	PPR logging uses buffer B exclusively.
10b	Automatically swap buffers when one becomes full.
11b	<i>Reserved.</i>

It is an error to set DualPprLogEn to 10b if the IOMMU does not support autoswap.

The dual PPR log feature defines three registers that allow system software to set up and manage the alternate PPR Log (Log B). These are:

- PPR Log B Base Address Register [MMIO Offset 00F0h]
- PPR Log B Head Pointer Register [MMIO Offset 2050h]
- PPR Log B Tail Pointer Register [MMIO Offset 2058h]

See individual register definitions for information on the format of these registers.

Fields in the **IOMMU Status Register** [MMIO Offset 2020h] provide real-time information about both logs. The `PprLogActive` field indicates which log is currently being filled. `PprOvrflwB` is set by hardware when Log B overflows.

Note: If the overflow bit of the log to be swapped to is set when a log swap is about to occur, an error is logged.

See **Section 2.6.4 [PPR Log Overflow Protection]** on page 178 for more information about autoswap and other optional features that further reduce the likelihood of PPR Log overflow.

2.6.2 Peripheral Page Request Log Restart Procedure

The IOMMU PPR logging is disabled after system reset and when the PPR log overflows. The IOMMU discards PPR requests until PPR logging is enabled, setting **MMIO Offset 2020h**[`PprOverflow`] to indicate the loss of PPR request information. To restart the IOMMU PPR request logging after the PPR log overflows, use the following procedure.

- Wait until **MMIO Offset 2020h**[`PPRLogRun`]=0b so that all request entries are completed as circumstances allow. `PPRLogRun` must be 0b to modify the PPR log registers safely.
- Write **MMIO Offset 0018h**[`PPRLogEn`]=0b.
- As necessary, change the following registers (e.g., to relocate or resize the PPR log):
 - the **PPR Log Base Address Register** [MMIO Offset 0038h],
 - the **IOMMU PPR Log Head Pointer Register** [MMIO Offset 2030h], and
 - the **IOMMU PPR Log Tail Pointer Register** [MMIO Offset 2038h].
- Write **MMIO Offset 2020h**[`PprOverflow`] = 1b to clear the bit (W1C).
- Write **MMIO Offset 0018h**[`PPRLogEn`] = 1b, and either set **MMIO Offset 0018h**[`PprIntEn`] to enable the Event log interrupt or clear the bit to disable it.

The IOMMU now creates PPR request log entries for new requests.

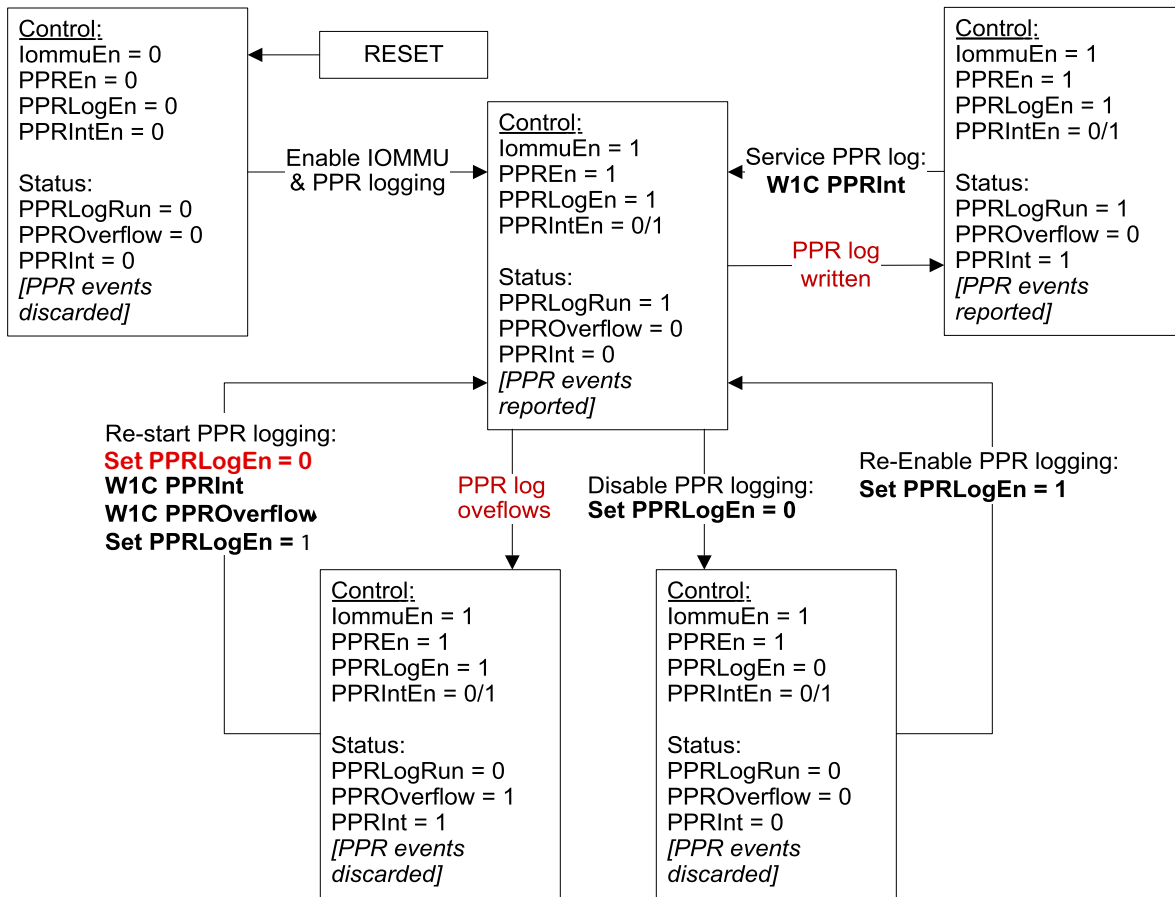

Figure 72: PPR Log State Diagram

All PPR requests recorded by the IOMMU consist of a 4-bit PPRCode together with two operands, which may be respectively 60 and 64 bits long, for a total of 128 bits (16 bytes) per record.

The IOMMU must set the Coherent bit in the HyperTransport™ packet when generating writes to the PPR log.

31	28 27	0
First event code dependent operand [31:0]		+00
PPRCode[3:0]	First event code dependent operand [59:32]	+04
Second event code dependent operand [31:0]		+08
Second event code dependent operand [63:32]		+12

Figure 73: Generic Peripheral Page Request Log Buffer Entry Format

2.6.3 Peripheral Page Request Entry

When a peripheral needs memory page services, it issues a special bus request to the IOMMU. If supported (see MMIO Offset 0030h[PPRSup] and MMIO Offset 0018h[PPREn]), the IOMMU converts the special bus request to the PAGE_SERVICE_REQUEST format. When peripheral page service is

enabled for the device (see [MMIO Offset 0018h](#)[PPRLogEn]), the IOMMU creates a PAGE_SERVICE_REQUEST entry in the PPR log buffer. Certain types of ill-formed PCIe PRI requests are logged in the PPR request log with RZ=1 so that software may attempt recovery (e.g., reserved bit error in [Figure 41](#)). When peripheral page request processing is not enabled, the IOMMU creates an entry in the IOMMU event log to report the error (see [Section 2.5.10 \[INVALID_PPR_REQUEST Event\]](#)). After processing the request, software issues a COMPLETE_PPR_REQUEST command to inform the peripheral that page service processing is complete (see [Section 2.4.7 \[COMPLETE_PPR_REQUEST\]](#)).

If the PCIe PRI request has a PASID TLP prefix with a valid PASID, it is a GVA request and the header contains a PASID. If the PRI request packet lacks a PASID TLP prefix with a valid PASID, it is a nested (GPA) request and the PASID in the log entry must be ignored by software. The presence of a valid PASID is indicated to software by the GN bit in the log entry.

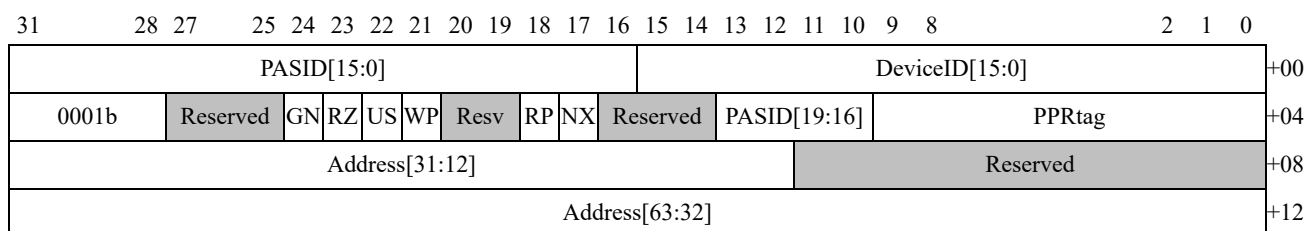

Figure 74: PAGE_SERVICE_REQUEST PPR Log Buffer Entry Format

Table 74: PAGE_SERVICE_REQUEST PPR Log Buffer Entry Fields

Bits	Description
31:16 +00	PASID[15:0] . Specifies PASID[15:0] that requested the page service. PASID is valid when GN=1 and is ignored by software when GN=0.
15:0 +00	DeviceID . Specifies the DeviceID that requested the page service. The IOMMU domain can be determined using the DeviceID field. The page to be serviced can be determined from the Address field.
31:28 +04	0001b . Specifies a PAGE_SERVICE_REQUEST from the peripheral identified in the DeviceID field.
27:25 +04	Reserved.
24 +04	GN: Guest/nested . 1=Address[63:12] is a GVA and PASID is valid. 0=Address[63:12] is a GPA and PASID should be ignored by software.
23 +04	RZ: reserved bit not zero or reserved encoding . 1=The received peripheral request had a non-zero reserved bit or used a reserved encoding. The rest of the request has been reported as it was received. Software may attempt recovery. 0=The received peripheral request passed all hardware validation checks.
22 +04	US: User/Supervisor . The U/S request received from the peripheral. 1 = user level access requested. 0 = supervisor access requested.

Table 74: PAGE_SERVICE_REQUEST PPR Log Buffer Entry Fields (Continued)

Bits	Description
21 +04	WP: write permission requested. 1=peripheral is requesting write access. 0=write access may be denied.
20:19 +04	Reserved.
18 +04	RP: read permission requested. 1=peripheral is requesting read access. 0=read access may be denied.
17 +04	NX: execute permission requested. 0=peripheral instruction fetch access should be handled as a read request. 1=peripheral is requesting NX handling of access requests (instruction fetch requests will be blocked, read requests are to be allowed when RP=1).
16:14 +04	Reserved.
13:10 +04	PASID[19:16]. Specifies PASID[19:16] that requested the page service. PASID is valid when GN=1 and is ignored by software when GN=0.
9:0 +04	PPRtag: protocol tag. This field contains a protocol-dependent tag. When the PPR request originated as a PCIe page request message, PPRtag[9] is the PRI L bit and PPRtag[8:0] is the PRI PRG index; the IOMMU is required to return the PRG index in the response message (see Section 2.4.7 [COMPLETE_PPR_REQUEST]).
31:12 +08	Address[31:12]. The address field contains the DVA that the device was attempting to access. The minimum invalidation granularity is a 4-Kbyte page so the address is truncated. See also GN and PASID fields.
11:0 +08	Reserved.
31:0 +12	Address[63:32]. The Address field contains the DVA that the device was attempting to access. See also GN and PASID fields.

The log entry is designed to carry a full set of independent read-, write-, and execute-permission bits; any bits not provided by the underlying peripheral protocol are set to the “permitted” state by the IOMMU (see also [MMIO Offset 0030h\[NXSup\]](#)).

2.6.4 PPR Log Overflow Protection

The architecture provides a number of optional features that drastically reduce the likelihood of a PPR Log overflow. These features are:

- PPR Auto Response
- PPR Log Dual Buffering
- PPR Auto Response Always-on
- PPR Log Overflow Early Warning
- Block StopMark Messages

2.6.4.1 PPR Auto Response

The PPR auto response feature is supported when [MMIO Offset 0030h](#)[PprAutoRespSup] = 1. When enabled (by setting [MMIO Offset 0018h](#)[PprAutoRspEn] to 1), the IOMMU starts generating automatic PPR responses to the requesting I/O device when the currently active PPR log has reached an PPR Log at limit state.

The IOMMU only generates responses for peripheral page requests with the L bit set in the original request, with the exception of stop marker messages, which are dropped when there is no space in the log. All other peripheral page requests (L = 0) are dropped without any response when the log is full.

When the auto response is enabled, system software does not need to manually restart PPR logging when the log has reached an at limit state. The PPR log automatically recovers regular operation when log entries are freed up.

The PPR auto response feature is not available in autoswap mode ([MMIO Offset 0018h](#)[DualPprLogEn = 10b]).

The automatically generated PPR responses have “successful” completion code by default. This can be changed by system software, if required, by programming the PprAutoRespCode field of the [PPR Log Overflow Early Indicator Register](#) [[MMIO Offset 2088h](#)]. The PprAutoRespMskGn bit of the same register can be used to eliminate the PASID field in all the PPR auto response.

Automatically generated PPR responses to PPR requests with PASID are returned with the same PASID when DTE[GPRP]=1 otherwise PPR response is returned without a PASID.

Note: PPR auto response behavior is slightly different when enabled with PPR early overflow. This behavior is described below.

2.6.4.2 PPR Log Dual Buffering

PPR Log dual buffering provides an alternate PPR Log (Log B) buffer space that can be programmed to capture peripheral page requests when the default PPR Log (Log A) becomes full. PPR Log dual buffering is described in [Section 2.6.1 \[PPR Log Dual Buffering\]](#) on page 174.

2.6.4.3 PPR Log Overflow Early Indication

The PPR log early overflow indication feature helps prevent PPR Log overflow by providing a indication to system software when the number of free entries in a PPR Log has reached a programmable threshold value. This feature is supported when [MMIO Offset 0030h](#)[PprOvrflwEarlySup] = 1.

The PPR Log overflow early warning feature defines two new registers:

- [PPR Log Overflow Early Indicator Register](#) [[MMIO Offset 2088h](#)] and
- [PPR Log B Overflow Early Indicator Register](#) [[MMIO Offset 2090h](#)]

The second register is only supported if the PPR Log dual buffering feature is supported.

The first register is used to set the threshold for the overflow early warning for the default PPR Log (also known as PPR Log A when PPR log dual buffering is supported and enabled). The second register is used to set the threshold for the overflow early warning for PPR Log B.

The IOMMU can be programmed to generate an MSI interrupt when the number of free entries in the PPR Log A drops below the threshold specified by [MMIO Offset 2088h](#)[PprOvrflwEarlyThreshold]

or when the number of free entries in the PPR Log B drops below the threshold specified by [MMIO Offset 2090h](#)[PprOvrflwEarlyThreshold]. The PprOvrflwEarlyIntEn bit of the respective threshold registers is used to enable the interrupt.

The PPR Log overflow early warning feature is not available in autoswap mode ([MMIO Offset 0018h](#)[DualPprLogEn = 10b]).

The PPR logger behavior is slightly different when PPR auto response and early overflow are enabled at the same time. The PPR logger generates an MSI interrupt when the number of free entries drops below the specified threshold as usual. When number of free entries in the PPR logger falls below the threshold, IOMMU begins to generate auto responses. Auto responses are generated for peripheral page requests with L bit set and the rest are silently dropped.

PPR Stop marker messages are treated uniquely allowing them to be logged in the PPR Log even when the number of free entries is below the threshold, unless Stop marker messages are set to be dropped. The PPR logger resumes normal operation when system software has consumed entries from the log and the free space is more than the threshold.

2.6.4.4 PPR Auto Response Always-on

The PPR auto response always-on feature builds on the auto response feature. When this feature is enabled, the IOMMU returns auto responses for peripheral page requests all the time regardless the PprOvrflwEarlyThreshold value. The feature is intended to eliminate an overflow of the PPRLOG buffer, if software cannot process it in time.

The PPR auto response always-on feature is enabled when [MMIO Offset 0018h](#)[PprAutoRspAon] = 1. This feature requires that PPR Auto Response also be enabled. This feature should be turned on (along with PPR auto response) whenever system software is dynamically relocating or resizing the log.

The PPR auto response always-on feature is supported on all implementations that support the PPR auto response feature.

2.6.4.5 Block StopMark Messages

The Block StopMark Messages feature provides the capability for the IOMMU to silently drop all the stop marker messages without error. This feature includes an internal performance event counter to count the number of stop marker messages that have been discarded since the counter was reset.

This feature is supported if [MMIO Offset 0030h](#)[BlkStopMrkSup] = 1. If supported, this feature is enabled by default. To disable the feature, [MMIO Offset 0018h](#)[BlkStopMrkEn] should be set to 0.

2.7 Guest Virtual APIC (GA) Logging

An IOMMU that supports the guest virtual APIC feature ([MMIO Offset 0030h](#)[GASup] = 1) can deliver interrupts directly to a running guest operating system in a virtual machine when used with an AMD processor that supports the Advanced Virtual Interrupt Controller (AVIC) architecture. This architecture defines the behavior and the system programming interface for the guest virtual APIC (vAPIC). See the full description of AVIC in Chapter 15 of *AMD64 Architecture Programmer's Manual, Volume 2: System Programming*, order #24593.

Guest vAPIC logging is used to record device interrupt requests that could not be immediately delivered to the target virtual processor due the fact the target was not running. When logging is enabled and an interrupt request for a non-running virtual processor arrives from an I/O device, the IOMMU creates an entry in the GALog. This entry records the Device ID of the requesting device and the GATag of the target vAPIC. System software supplies the GATag by writing it in the appropriate IRTE of the Interrupt Remap Table for the device.

2.7.1 Guest vAPIC Virtual Interrupt Request Log

The guest vAPIC virtual interrupt request log (GA Log) is diagrammed in [Figure 75](#) below.

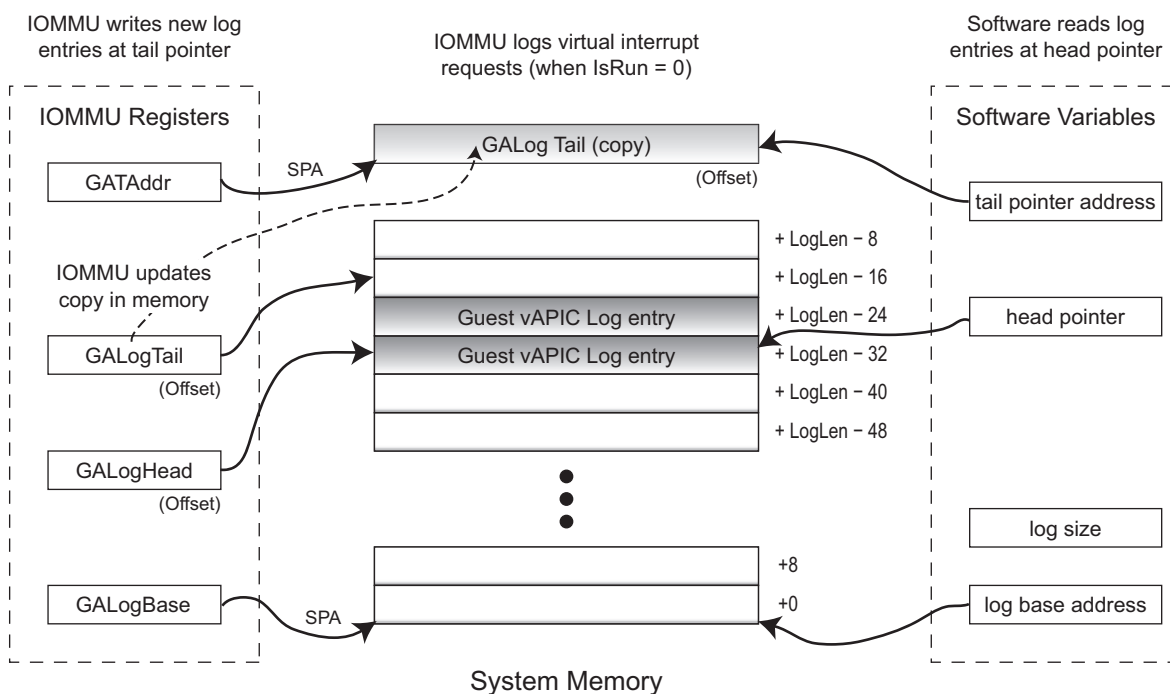

Figure 75: Guest vAPIC Log in System Memory

The GA Log is circular buffer in system physical memory that provides a queue of virtual interrupt requests waiting to be delivered to their target virtual processors. These virtual interrupt requests could not be delivered immediately due to the non-running state of the target virtual processor. Log entries identify the source of the virtual interrupt request and the target virtual processor. The source is identified using the Device ID of the device initiating the interrupt request. The target is recorded using the GATag value assigned by system software.

When the IOMMU receives a virtual interrupt request from an I/O device it records the request by updating the appropriate IRR bit of vAPIC backing page of the vAPIC associated with the target virtual processor. If the target virtual processor is running at the time of the interrupt request, the IOMMU completes the delivery of the interrupt by sending a doorbell interrupt to the physical processor that is hosting the virtual processor.

If the target virtual processor is not running, delivery of the interrupt must be deferred. Instead of

causing a doorbell interrupt, the IOMMU logs the details of the request in the GA Log. The virtual interrupt remains pending until system software makes the targeted virtual processor active. When the virtual processor is again active it acts on the interrupt request that the IOMMU has already set in the IRR of the vAPIC backing page. System software utilizes information logged in the GALog to make virtual processor scheduling decisions.

Guest virtual APIC event logging is enabled when MMIO Offset 0018h[GAEEn] = 1, MMIO Offset 2020h[GALogRun] = 1, and IRTE[GALogIntr] = 1 (see Figure 18). The IRTE[IsRun] field indicates whether or not the target virtual processor is running.

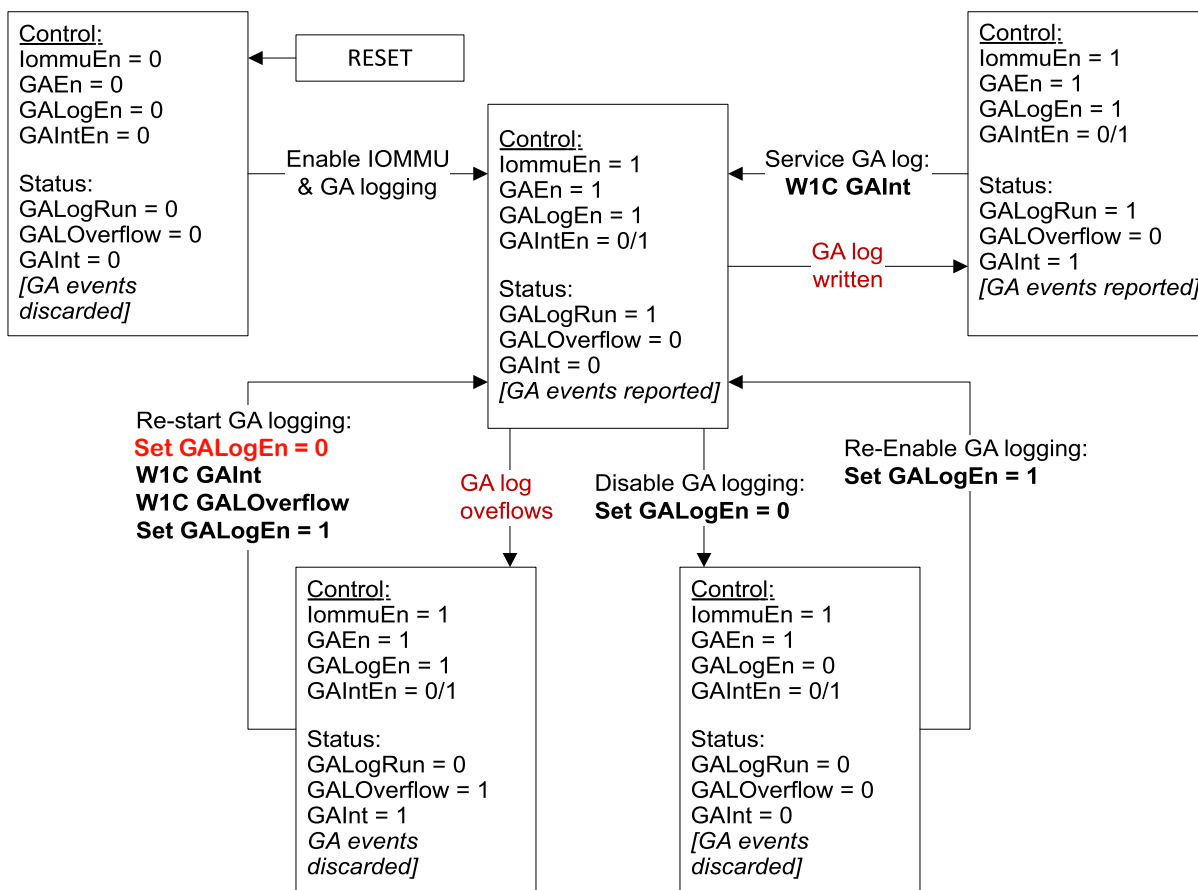

Figure 76: Guest Virtual APIC Log State Diagram

When logging a virtual interrupt request in the GA Log, the IOMMU writes the next available GA Log entry. Assuming the log is not full, this is the entry pointed to by the GA Log tail pointer (MMIO Offset 2048h[GALogTail]). After writing the new log entry, the IOMMU advances the GA Log tail pointer and sets the MMIO Offset 2020h[GAInt] bit. If enabled via MMIO Offset 0018h[GAIntEn] = 1, the setting of the GAInt bit generates a message signalled interrupt using the MSI number specified by Capability Offset 14h[MsiNumGA].

To find the next entry to be processed, system software reads the GALog entry at the location pointed

to by the GA Log head pointer and advances the head pointer to indicate that it has consumed the entry. After it advances the head pointer, it compares the new value of the head pointer to the current value of the tail pointer. (The IOMMU maintains a copy of its GA Log tail pointer in system memory at the system physical memory location pointed to by [MMIO Offset 00E8h](#).) If the new value of the head pointer is equal to the tail pointer, there are no more entries in the log for system software to consume. If head and tail pointers are not equal, this indicates there are more entries in the GA Log.

When done processing one or more GA Log entries, system software writes the new value of the head pointer to the IOMMU head pointer register ([MMIO Offset 2040h](#)) to indicate to the IOMMU that the consumed entries in the GA Log have been freed up. The IOMMU uses this value to determine if the log is full. The GA Log is considered full if the tail pointer is pointing at the entry immediately below the head pointer. Note that since the buffer is circular that “below” does not always mean at a numerically smaller offset. Since the tail pointer always points at the entry to be written next, the last entry (the one immediately below the head) in the circular buffer always remains unused.

If the log is full at the time of the arrival of the virtual interrupt request, logging is suspended and [MMIO Offset 2020h](#)[GALOverflow] is set to 1. When this occurs software must intervene to resume logging.

Note that the IOMMU maintains a copy of the tail pointer register ([MMIO Offset 2048h](#)) in system memory at the location specified by the contents of the register [MMIO Offset 00E8h](#) to reduce the latency involved in reading the current value of the tail pointer from the internal register.

The [Guest Virtual APIC Log Base Address Register](#) [[MMIO Offset 00E0h](#)] is used by system software to assign the system physical address of the guest vAPIC log and to define its size. The guest vAPIC log occupies contiguous physical memory starting at the programmed base address up to the programmed size. The size of the guest virtual APIC log must be a multiple of 4 Kbytes (to facilitate “modulo N” indexing for circularity) and can be as large as 8192 entries (corresponding to a 64-Kbyte buffer). The base address of the GA log must be aligned to a multiple of 4 Kbytes.

System software uses the [Guest Virtual APIC Log Tail Address Register](#) [[MMIO Offset 00E8h](#)] to assign the system physical address of the location where IOMMU maintains the copy of the guest vAPIC Log tail pointer.

Software is responsible to initialize the head and tail pointers to zero to create an empty log before enabling guest vAPIC event logging. When the head pointer and the tail pointer are equal, the guest virtual APIC event log is empty.

To add an entry to the guest virtual APIC log, the IOMMU proceeds as follows:

1. Compare the GA Log head and tail pointers ([MMIO Offset 2040h](#)[GALogHead] and [MMIO Offset 2048h](#)[GALogTail]) to determine if the log is full.
Let $Head = GALogHead \gg 3$, $Tail = GALogTail \gg 3$, and $Max = GA\ Log\ size \gg 3$.
If $\{(Head \geq Tail) ? Tail : Tail + Max\} - Head = (Max - 1)$, then the log is full.
2. If the log is already full, set the overflow bit APIC log overflow and cease guest virtual APIC logging.
3. If the log is not full, write a 64-bit log entry to the guest virtual APIC log in memory (see [Table 75](#)),

4. Increment the register copy of the tail pointer (modulo the size of the log, see [MMIO Offset 00E0h\[GALogLen\]](#)),
5. Write the new tail pointer value to the [Guest Virtual APIC Log Tail Pointer Register \[MMIO Offset 2048h\]](#),
6. Write the new tail pointer value to the shadow tail pointer in memory (see [Guest Virtual APIC Log Tail Address Register \[MMIO Offset 00E8h\]](#)), and
7. Send a guest virtual APIC log interrupt, if enabled.

The guest virtual APIC log has overflowed when an interrupt request is received by the IOMMU that is to be logged and would otherwise consume the last unused slot. The log is empty when the [Guest Virtual APIC Log Head Pointer Register \[MMIO Offset 2040h\]](#) and [Guest Virtual APIC Log Tail Pointer Register \[MMIO Offset 2048h\]](#) are equal.

The guest virtual APIC event log is full when all slots but one are used. The IOMMU uses the same interrupt to signal when the guest virtual APIC log is written or overflows. The guest virtual APIC log has overflowed when a request occurs that is to be logged and would otherwise consume the last unused slot. When the guest virtual APIC log has overflowed, the [MMIO Offset 2020h\[GALOverflow\]](#) bit is set, any data for new virtual APIC events is discarded, and logging is disabled. Host software must make space in the log by reading entries (by adjusting the head pointer) before Guest virtual APIC event logging may then be restarted.

2.7.2 Guest Virtual APIC Log Entry (Generic)

All GA requests recorded by the IOMMU are 64-bit (8-byte) records. The IOMMU must set the Coherent bit in the HyperTransport™ packet when generating writes to the GA log.

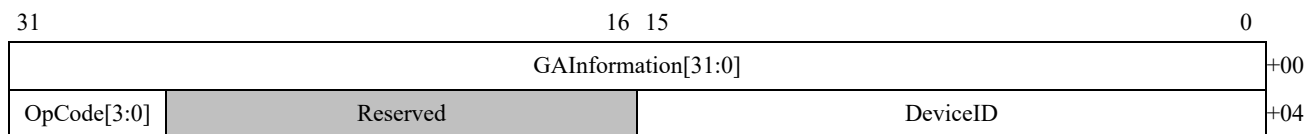

Figure 77: Generic Guest Virtual APIC Log Buffer Entry Format

2.7.3 Guest Virtual APIC Request Entry (GA_GUEST_NR)

When the IOMMU receives an interrupt request for which IRTE[IsRun] indicates the guest OS is not running, it records the interrupt in the backing page for the virtual APIC and signals the hypervisor of the undelivered interrupt. If supported (see [MMIO Offset 0030h\[GASup\]](#) and [MMIO Offset 0018h\[GAEEn\]](#)), the IOMMU processes guest virtual interrupt requests. When the guest virtual APIC is in use for the device and the guest OS is not running (see IRTE[GuestMode] and IRTE[IsRun]), the IOMMU creates a new GA_GUEST_NR entry in the guest virtual APIC event log buffer.

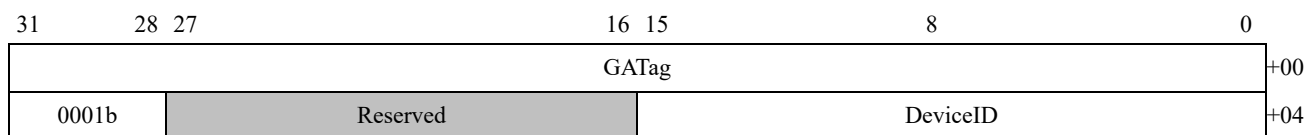

Figure 78: GA_GUEST_NR Log Buffer Entry Format

Table 75: GA_GUEST_NR Log Buffer Entry Fields

Bits	Description
31:0 +00	GATag[31:0] . Specifies the GATag taken from the IRTE entry (see Figure 18 and Table 22) that requested the virtual interrupt service for the guest found to be not-running.
31:28 +04	0001b . Specifies a GA_GUEST_NR from the peripheral identified in the DeviceID field.
27:16 +04	Reserved.
15:0 +04	DeviceID . Specifies the DeviceID that requested the guest virtual interrupt service.

The log entry contains a GATag field for software use.

2.7.4 Guest Virtual APIC Log Restart Procedure

The IOMMU guest virtual APIC logging is disabled after system reset and when the log overflows. The IOMMU does not log guest virtual APIC events until logging is enabled, setting [IOMMU Status Register \[MMIO Offset 2020h\]\[GALOverflow\]](#) to indicate that guest APIC events are not being logged. To restart the guest virtual APIC event logging after the log overflows, use the following procedure.

- Wait until [MMIO Offset 2020h\[GALogRun\]](#)=0b so that all request entries are completed as circumstances allow. GALogRun must be 0b to modify the guest virtual APIC log registers safely.
- Write [MMIO Offset 0018h\[GALogEn\]](#)=0b.
- As necessary, change the following values (e.g., to relocate or resize the guest virtual APIC event log):
 - the [Guest Virtual APIC Log Base Address Register \[MMIO Offset 00E0h\]](#),
 - the [Guest Virtual APIC Log Head Pointer Register \[MMIO Offset 2040h\]\[GALogHead\]](#), and
 - the [Guest Virtual APIC Log Tail Pointer Register \[MMIO Offset 2048h\]\[GALogTail\]](#).
- Write [MMIO Offset 2020h\[GALOverflow\]](#) = 1b to clear the bit (W1C).
- Write [MMIO Offset 0018h\[GALogEn\]](#) = 1b, and either set [MMIO Offset 0018h\[GALogEn\]](#) to enable the GA log interrupt or clear the bit to disable it.

The IOMMU now creates guest virtual APIC event log entries for new events.

2.8 IOMMU Interrupt Support

The IOMMU supports the signaling of interrupts using both the MSI and the MSI-X mechanisms. However, only one mechanism can be enabled at a time. The MSI capability must support 64-bit addressing. The IOMMU must not set the PassPW bit when sending interrupts associated with the IOMMU over HyperTransport™ links.

The IOMMU supports generation of an interrupt when the event log is updated or overflows and when a completion wait command completes (see [Capability Offset 10h\[MsiNum\]](#), [MMIO Offset](#)

0018h[ComWaitEn], and MMIO Offset 0018h[EventIntEn]), and when the peripheral page request log is updated or overflows (see Capability Offset 10h[MsiNumPPR] and MMIO Offset 0018h[PprIntEn]).

2.9 Memory Address Routing and Control (MARC)

The Memory Access Routing and Control (MARC) feature provides simple, static memory virtualization and access protection for SoC-integrated devices that require low-latency access to system memory. MARC provides this address virtualization while avoiding the need for costly page table walks. MARC hardware is set up and controlled by trusted system software.

When a device virtual address (DVA) lies within one of the defined regions (MARC aperture) and access permissions checking allows the access requested by the device, the IOMMU translation mechanism is bypassed and MARC provides the system physical address to be used for the access. If the DVA does not lie within one of the programmed and enabled apertures, or the access is denied based on permissions checking, the address is passed to the IOMMU without flagging an error. The IOMMU will then use the translation and permissions information in its page tables to check the access. If a translation is available and permissions checking allows the access, the IOMMU will complete the translation.

Each MARC aperture is defined by programming a base and a length register. For each aperture, a third relocation register provides the system physical address (SPA) to which that region in the DVA space is mapped. Access protection and an enable bit are provided by fields in the relocation register. The mechanism maps aligned 4-Kbyte pages of address space.

A given implementation may support either four or eight MARC apertures. MMIO Offset 0030h[MarcSup] supplies the number of MARC apertures supported by a given implementation. MMIO Offset 0018h[MarcEn] provides a global enable for the MARC feature. If MarcEn is set to 0, all DVAs emitted by I/O devices are sent to the IOMMU for translation.

The relocation register for each aperture MARC Aperture [0–3] Relocation Register [MMIO Offset 02[08,20,38,50]h] provides a RelocEn bit to enable each individual aperture 0–3 and a ReadOnly bit to establish the device access allowed for each aperture. When ReadOnly is programmed to 0, device read or write access is allowed; when programmed to 1, only read access is allowed. When RelocEn is set to 0, the corresponding aperture is ignored.

The MARC mechanism maps addresses at a 4-Kbyte granularity. The architecture supports 52-bit addresses. Thus only address bits [51:12] of the DVA are examined. Interpreted as an unsigned integer, this corresponds the page frame number (PFN).

The PFN of the DVA is compared with the PFN specified by the value of bits [51:12] of the MARC Aperture [0–3] Base Register [MMIO Offset 02[00,18,30,48]h]. If the difference is greater than or equal to zero but less than MarcLength specified by bits [51:12] of the MARC Aperture [0–3] Length Register [MMIO Offset 02[10,28,40,58]h], the DVA falls within the corresponding MARC aperture and the access permission for that aperture is checked. If requested access type (read or write) is allowed by the setting of ReadOnly for that aperture, the access is allowed and bits [51:12] of the relocation register are substituted for bits [51:12] of the DVA. The byte offset within the page is provided by bits [11:0] of the DVA.

To define an aperture of one 4-Kbyte page, `MarcLength` is programmed to 1. If a value of 0 is used, the behavior of the hardware is implementation-dependent, but does not result in an error.

2.10 vIOMMU

The vIOMMU feature may be used to accelerate multiple guest IOMMUs. vIOMMU allows the IOMMU hardware to directly access and process guest data structures, such as the guest command buffers, guest peripheral page request logs, and guest event logs. It also allow the IOMMU hardware to send interrupts directly to the guest IOMMU drivers. This feature is supported if [MMIO Offset 0030h](#)[`vIommuSup`]=1. When enabled, `DTE[vImuEn]`=1 indicates the guest owning this device is a vIOMMU enabled guest, and IOMMU should write event and peripheral page requests associated with this device into the guest data structures. `DTE[GuestID]` specifies the guest ID associated with the device. `GuestID` is an opaque identifier for a VM. All devices assigned to the VM must share the same `DTE[GuestID]` value, and the same `DTE[vImuEn]` settings.

Host software must allocate MMIO resources for the IOMMU Virtual Function MMIO region and IOMMU Virtual Function Control MMIO region. Software must further map a portion of each Guest IOMMU's MMIO register space onto a portion of the IOMMU Virtual Function MMIO region. When vIOMMU is enabled, host software must enable the Guest Virtual APIC feature ([MMIO Offset 0018h](#)[`GAEn`]).

Host software should map a VM-specific IVRS ACPI table to the VM view that reflects the appropriate base addresses and features (e.g. MMIO Base address, EFR, IVHD/IVMD substructures) reflecting the appropriate addresses and features to the guest OS utilizing the IOMMU.

2.10.1 vIOMMU Private Address Space

When vIOMMU is enabled, software must manage a new IOMMU private address space. The private address space is accessed by the IOMMU using the host page table referenced by the Device Table Entry associated with the device ID of the IOMMU. The private address space maps both private backing storage memory used by vIOMMU and Guest IOMMU memory data structures. The Guest IOMMU memory data structures are also mapped into the guest physical address space of each VM and are backed by real memory.

The DTE for the IOMMU's DeviceID must be set with `V=1`, `TV=1`, `GV=0`, `Mode=100b`.

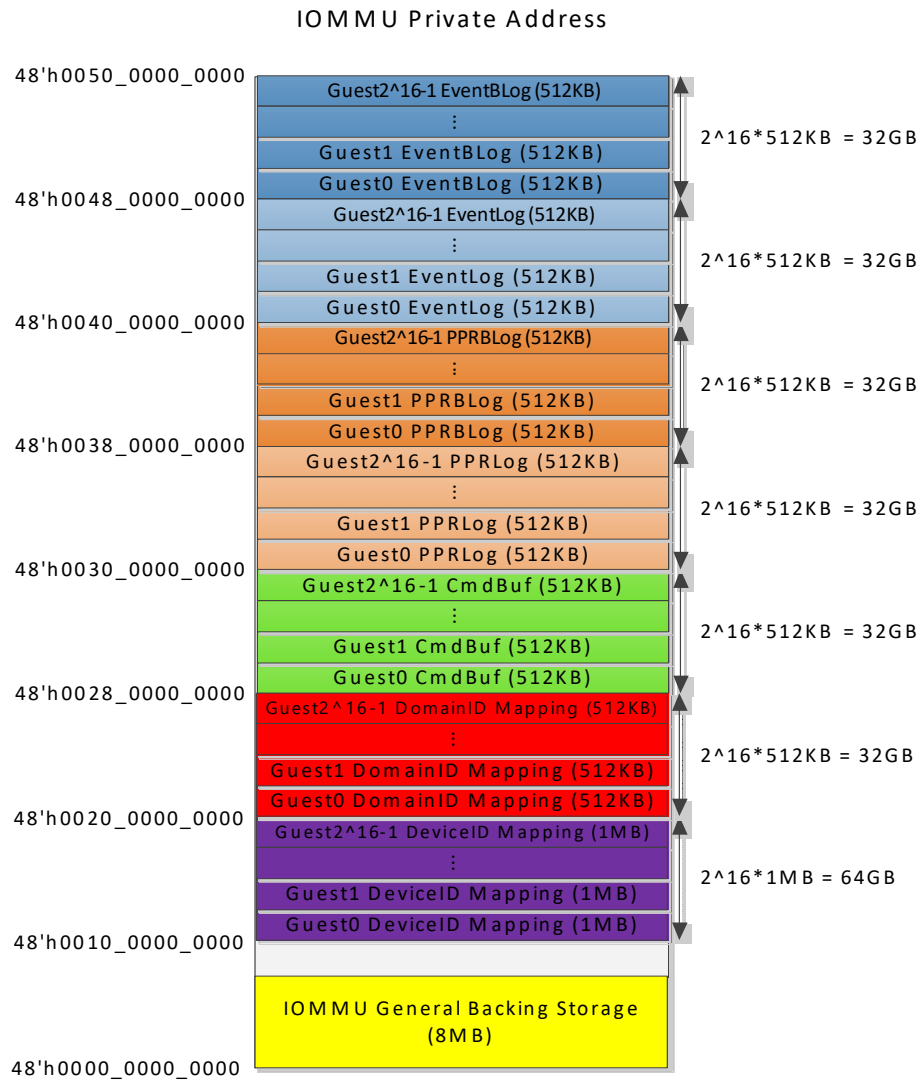

Figure 79: IOMMU Private Address Map

2.10.1.1 vIOMMU Backing Storage Memory

Host software must allocate unpinned memory buffers for the following regions of the IOMMU address space. These buffers should be treated as uncacheable by software.

Table 76: Pinned Memory Buffer Regions

Size	Starting Address	Notes
8MB	0000_0000_0000h	This memory must be allocated regardless of the number of VMs. The underlying memory may not be shared between IOMMU instances. Software must initialize this region of memory to all-zero prior to enabling vIOMMU.
1MB	0010_0000_0000 + (N<<20)	This region is allocated for each GuestID=N that uses vIOMMU. This contains the DomainID mapping table. Software must initialize the region of memory associated with a Guest to all-zero prior to enabling that Guest.
512KB	0020_0000_0000 + (N<<19)	This region is allocated for each GuestID=N that uses vIOMMU. This contains the DeviceID mapping table. Software must initialize the region of memory associated with a Guest to all-zero prior to enabling that Guest.

2.10.2 vIOMMU MMIO Resources

The vIOMMU feature adds two additional MMIO resources. The Virtual Function MMIO (VFMMIO) region is used by Guests to access IOMMU MMIO registers implemented by vIOMMU hardware. The Virtual Function Control MMIO (VFCntlMMIO) region is used by the Hypervisor software to communicate Guest<->Host mappings used by vIOMMU.

BIOS software is expected to allocate MMIO resources for both of these regions.

Hypervisor software is responsible for mapping guest IOMMU MMIO accesses between offsets 2000h and 2FFFFh onto the aligned 4KB section of the VFMMIO region corresponding to guest's vIOMMU GuestID value. All other guest MMIO addresses are not handled by vIOMMU hardware and must be emulated.

Software must access the VFCntlMMIO region using either 1DW or 2DW accesses with all byte enables set.

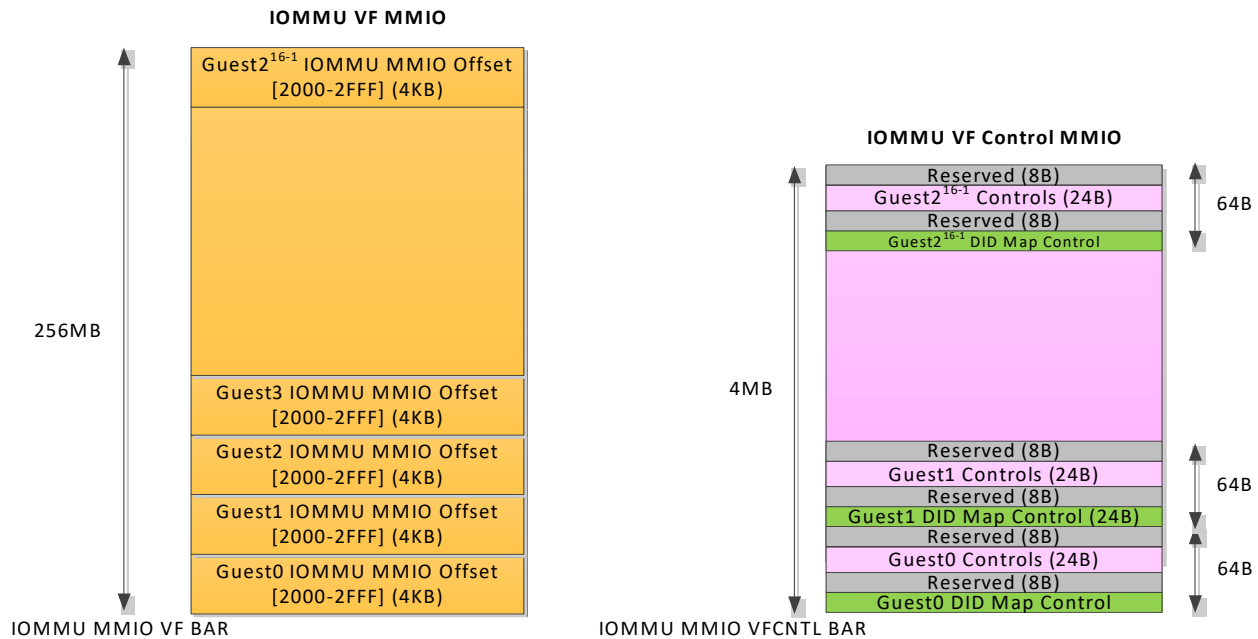

Figure 80: IOMMU Virtual Function Control MMIO and IOMMU Virtual Function MMIO

2.10.3 vIOMMU Event Logging

When IOMMU hardware detects an error, the IOMMU hardware logs an event into the host event log. The Host software received the log and determine whether the log should be communicated to the guest. For a vIOMMU enabled guest, host software must inject the emulated event into the guest event log via the host IOMMU command buffer.

The Host software writes an INSERT_GUEST_EVENT command followed by an event entry into the IOMMU command buffer to indicate the command immediately after the INSERT_GUEST_EVENT command is an event that IOMMU needs to be written to the guest event log. IOMMU will not validate the contents of the guest event entry before injecting it into the guest event log. Host software is responsible for processing the event log entry to be suitable for guest consumption, for example, by changing addresses from SPA to GPA format.

2.10.4 vIOMMU Extended Interrupt Remapping

When vIOMMU is enabled, the IOMMU utilizes the Guest Virtual APIC features to send interrupts from Guest IOMMUs directly to the appropriate vCPUs. The Interrupt Remapping Table used by the IOMMU's own DTE is extended to 2-levels.

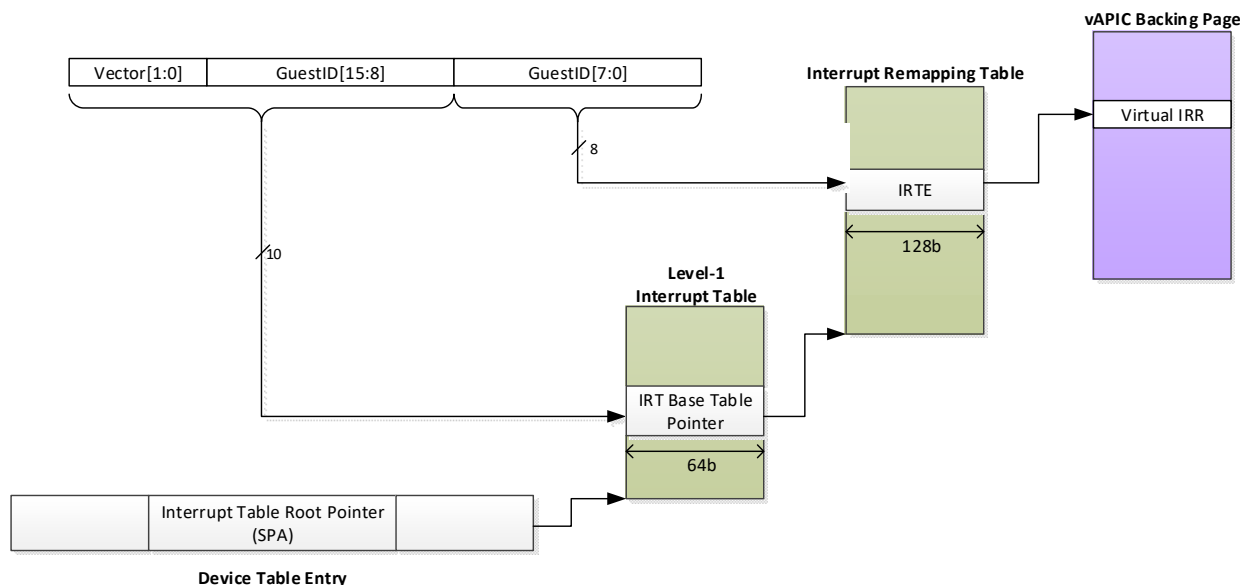

Figure 81: Extended Interrupt Remapping Table

The Interrupt Table Root Pointer [51:6] in the DTE becomes the base pointer to the Level-1 Interrupt Table. The IntTabLen in the DTE becomes the length of the Level-1 Interrupt Table. SW must allocate a two consecutive 4K page for the Level 1 Interrupt Table.

Vector[1:0] :

- 00 - Iommu event/general interrupt
- 01 - Iommu ppr interrupt
- 10 - Reserved
- 11 - Reserved

Level-1 Interrupt Table Entry Format

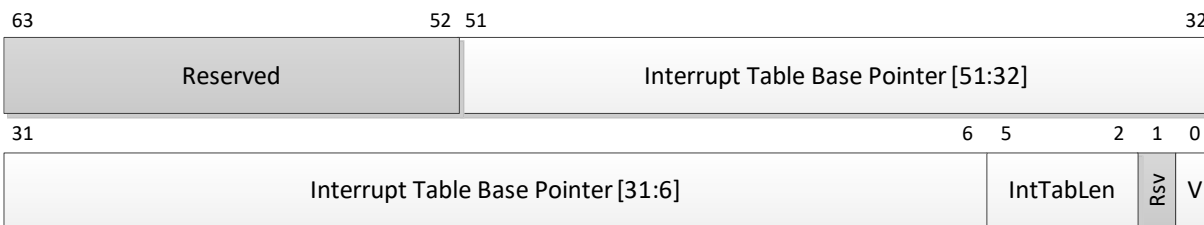

2.10.5 vIOMMU and EOI Bus Cycle

Use of the EOI special bus cycle is not supported in systems that enable the vIOMMU feature. The EOI special bus cycle is generated by writing the EOI or SEOI registers inside the LAPIC when the associated interrupt vector is configured as level sensitive. Software must instead configure all device interrupts as edge-triggered using the IOMMU interrupt remapping facilities. In addition to writing the EOI/SEOI register in the LAPIC, software must manually write the appropriate vector number into the EOI register in the IOAPIC that generated the interrupt request. The IOAPIC entry may continue to be configured as level sensitive.

2.11 Secure ATS Support

In normal non-secure processing of PCIe ATS requests, the IOMMU performs a full address translation and returns an SPA to the requesting device to be stored in that device's IOTLB. The device may subsequently issue Translated DMA containing SPAs. The IOMMU only check that the device was allowed to issue such requests by checking $DTE[I]=1$ and does not attempt to validate the SPA. Malicious devices or vulnerabilities in a device IOTLB might allow an attacker to generate DMA with arbitrary SPAs.

The IOMMU may optionally support processing ATS requests as secure ATS requests when IOTLB is supported and enabled, $EFER[SATSSup]=1$ and $DTE[SATS]=1$. When processing secure ATS requests, the IOMMU will walk the full page table as normal to determine whether the requested page is present and whether sufficient permissions are available. This allows the device to support unpinned memory access. Instead of returning the final SPA to the device, the IOMMU returns the previous GPA.

When receiving Translated DMA from a device with $DTE[SATS]=1$, the IOMMU performs in-line GPA to SPA translation. This ensures that any malicious devices or vulnerable IOTLB implementations do not have access to the full SPA space even if they can generate Translated DMA with arbitrary addresses.

2.12 IOMMU Secure Nested Paging (SEV-SNP) Support

The SEV-SNP feature is enabled in three stages. During initial boot, the BIOS software chooses whether to enable the system for SEV-SNP support. This is performed through device-specific methods. Next, the Hypervisor software prepares the system to use SEV-SNP. This includes having the IOMMU driver prepare the IOMMU for SEV-SNP. Hypervisor software must also issue the `SNP_INIT` command to the PSP. Finally, SNP-aware Guest VMs may be loaded.

The IOMMU driver software may check `MMIO Offset 0030h[SnpSup] = 1` to ensure the system supports SEV-SNP. It must also modify its behavior to conform to the restrictions for SNP-enabled systems described in the following sections.

This document refers to the system or IOMMU as being SNP-enabled after a successful `SNP_INIT` command is executed by the PSP. Note that this definition is different from the one used in APM2.

2.12.1 SEV-SNP RMP Access Checks

The IOMMU checks that all device DMA operations target Hypervisor-owned memory as identified

by the RMP. New event log entry formats are defined for faults related to checking the RMP. See Section 2.5.15 [RMP_HARDWARE_ERROR Event] on page 167 and Section 2.5.14 [RMP_PAGE_FAULT Event] on page 165.

2.12.2 SEV-SNP Restrictions

The following sections describe additional restrictions when using SEV-SNP.

2.12.2.1 SEV-SNP Register Locks

The following IOMMU registers become locked and are no longer writeable after the system becomes SNP-enabled:

- Device Table Base Address Register [MMIO Offset 0000h]
- Command Buffer Base Address Register [MMIO Offset 0008h]
- Event Log Base Address Register [MMIO Offset 0010h]
- IOMMU Control Register [MMIO Offset 0018h] fields:
 - MMIO Offset 0018h[IOMMUEn]
 - MMIO Offset 0018h[DevTblSegEn]
- IOMMU Exclusion Base Register / Completion Store Base Register [MMIO Offset 0020h]
- IOMMU Exclusion Range Limit Register / Completion Store Limit Register [MMIO Offset 0028h]
- PPR Log Base Address Register [MMIO Offset 0038h]
- Guest Virtual APIC Log Base Address Register [MMIO Offset 00E0h]
- Guest Virtual APIC Log Tail Address Register [MMIO Offset 00E8h]
- PPR Log B Base Address Register [MMIO Offset 00F0h]
- Event Log B Base Address Register [MMIO Offset 00F8h]
- Device Table Segment *n* Base Address Register [MMIO Offset 01[00–30]h]

2.12.2.2 SEV-SNP COMPLETION_WAIT Store Restrictions

On systems that are SNP-enabled, the store address associated with any host COMPLETION_WAIT command (s=1) is restricted. The Store Address must fall within the address range specified by the Completion Store Base and Completion Store Limit registers. When the system is SNP-enabled, the memory within this range will be marked in the RMP using a special immutable state by the PSP. This memory region will be readable by the CPU but not writable.

This change only applies to COMPLETION_WAIT commands issued through the host command buffer. It does not apply to commands issued through command buffers belonging to Guest IOMMUs, including those exposed through vIOMMU.

2.12.2.3 SEV-SNP Exclusion Range Restrictions

The exclusion range feature is not supported on systems that are SNP-enabled. Additionally, the Exclusion Base and Exclusion Range Limit registers are re-purposed to act as the Completion Store Base and Limit registers.

2.12.2.4 SEV-SNP Page Mode Restrictions

In SNP-enabled systems, software must set DTE[V]=1 for all devices in the system. The IOMMU aborts DMA operations from devices with DTE[V]=0 and reports ILLEGAL_DEV_TABLE_ENTRY.

The use of DTE[Mode]=0 is not supported on systems that are SNP-enabled. The IOMMU aborts DMA operations from devices with DTE[Mode]=0 and reports RMP_PAGE_FAULT.

For devices that only generate interrupts, such as IOAPIC, software is advised to set DTE[V]=1 and DTE[TV]=0 on SNP-enabled systems. IOMMU does not check DTE[Mode] if DTE[TV]=0.

2.12.3 SEV-SNP Guest Virtual APIC Support

On SNP-enabled systems, guest virtual APIC support is determined through [MMIO Offset 01A0h\[SNPAVICSup\]](#) instead of [MMIO Offset 0030h\[GAMSup\]](#). Additionally, guest virtual APIC interrupt remapping is controlled through [MMIO Offset 0018h\[SNPAVICEn\]](#) instead of [MMIO Offset 0018h\[GAMEn\]](#).

3 Registers

The IOMMU is configured and controlled via two sets of registers—one in the PCI configuration space and another set mapped in system address space. Since the IOMMU appears as a PCI function, it has a capability block in the PCI configuration space.

IOMMU registers not defined in this chapter are reserved. Software should not write reserved register locations and must not rely on the value returned by hardware if a reserved register is read. Bit ranges within writeable registers that are designated as *Reserved* should always be written as all zeros. When read, software must not rely on the value returned in that bit range.

3.1 PCI Resources

The IOMMU is implemented as an independent PCI Function. Any PCI Function containing an IOMMU capability block cannot be used for any purpose other than containing an IOMMU. A PCI Function containing an IOMMU capability block does not include PCI BAR registers. Configuration and status information for the IOMMU are mapped into PCI configuration space using a PCI capability block.

A peripheral may implement more than one IOMMU within a single Function. One or more IOMMU capability blocks may be implemented in a PCIe[®] Function.

If a single IOMMU capability block is implemented in a PCI Function, the IOMMU may support either MSI or MSI-X or both. If more than one IOMMU capability block is implemented in a Function, the IOMMU must support generating MSI-X interrupts. The Function must assign a distinct interrupt vector to each interrupt that can be generated by each IOMMU capability block.

The base functionality of the IOMMU supports one interrupt which is used report Event Log exceptions and CommWait Completions. If this interrupt is enabled, the field [Capability Offset 10h\[Msi-Num\]](#) must be written with the appropriate MSI/MSI-X vector. If PPR logging and GA logging are supported, two more interrupt sources are provided to signal PPR and GA logging exceptions. If the PPR log interrupt is to be enabled, a vector for it must be first set up for it in [Capability Offset 10h\[MsiNumPPR\]](#). If the GA log interrupt is to be enabled, a vector for it must be first set up in [Capability Offset 10h\[MsiNumGA\]](#).

The PCI class is System Base Peripheral (08h) with a subclass of IOMMU (06h) and a programming interface code of 00h, as issued by the PCI-SIG.

The HyperTransport[™] UnitID used when an IOMMU generates requests must not be used for any other traffic. A HyperTransport[™] UnitID can be shared by multiple IOMMUs within a physical component.

3.1.1 Accessing MSI Capability Block Registers

Optionally, specific fields of the MSI capability registers are mapped to MMIO space by IOMMU hardware. When this capability is supported these registers can be accessed either through configuration space reads and writes or via memory reads and writes. However, in some cases field write capability varies between configuration space and MMIO space access. See [Section 3.4.8 \[MMIO Access](#)

to MSI Capability Block Registers].

3.2 IOMMU Base Capability Block Registers

The presence of an IOMMU capability block in a PCIe Function indicates the presence of an IOMMU. The IOMMU capability block contains various registers to control the IOMMU and to configure the location of the MMIO registers of the IOMMU.

When [Capability Offset 04h\[Enable\]](#) is written with a 1b, all RW capability registers defined in this section are locked until the next system reset. This means the registers become read-only and attempts to write them are ignored.

Capability Offset 00h IOMMU Capability Header

This is the first register of the IOMMU capability block and provides information about capabilities that the IOMMU supports.

31	29	28	27	26	25	24	23	19	18	16	15	8	7	0
Reserved		CapExt	EFRSup	NpCache	HtTunnel	IotlbSup	CapRev		CapType		CapPtr		CapID	

Bits	Description
31:29	Reserved.
28	CapExt: 1 = indicates support for IOMMU Miscellaneous Information Register 1 [Capability Offset 14h] . 0 = Capability Offset 14h not supported.
27	EFRSup: IOMMU Extended Feature Register support. RO. Reset Xb. EFRSup = 1 indicates IOMMU Extended Feature Register [MMIO Offset 0030h] is supported. If EFRSup = 0, MMIO Offset 0030h is Reserved.
26	NpCache: Not present table entries cached. RO. Reset Xb. 1 = Indicates that the IOMMU caches page table entries that are marked as not present. When this bit is set, software must issue an invalidate after any change to a PDE or PTE. 0 = Indicates that the IOMMU caches only page table entries that are marked as present. When NpCache is clear, software must issue an invalidate after any change to a PDE or PTE marked present before the change. <i>Implementation Note:</i> For hardware implementations of the IOMMU, this bit must be 0b.
25	HtTunnel: HyperTransport™ tunnel translation support. RO. Reset Xb. Indicates that the device contains a HyperTransport™ tunnel that supports address translation on the HyperTransport™ interface.
24	IotlbSup: IOTLB Support. RO. Reset Xb. Indicates the IOMMU will support ATS translation request messages as defined in PCI ATS 1.0 or later.
23:19	CapRev: Capability revision. RO. Reset 0_0001b. Specifies the IOMMU interface revision. <i>Software Note:</i> this value is changed when architectural changes cause an interface incompatibility.
18:16	CapType: IOMMU capability block type. RO. Reset 011b. Specifies the layout of the Capability Block as an IOMMU capability block.
15:8	CapPtr: Capability pointer. RO. Reset XXh. Indicates the location of the next capability block, or 00h if this is the last capability block in the capability list.
7:0	CapId: Capability ID. RO. Reset 0Fh. Indicates a Secure Device capability block.

Capability Offset 04h IOMMU Base Address Low Register

This register specifies bits [31:14] of the base address (SPA) of the IOMMU control registers. This register is locked when IOMMU Base Address Low[Enable] is written with a 1b.

When [MMIO Offset 0030h](#)[PCSup] = 1, the IOMMU event counters are supported. The MMIO register area must be sized at 512 Kbytes and must be 512-Kbyte aligned. Base Address[18:14] must be set to 0_0000b. When [MMIO Offset 0030h](#)[PCSup] = 0, the IOMMU event counters are not supported. The MMIO area must be sized at 16 Kbytes and must be 16-Kbyte aligned. In this case, Base Address[31:14] may be set to any value.

31	19 18	14 13	1 0
BaseAddress[31:19]	BaseAddress[18:14]	Reserved	Enable

Bits	Description
31:19	BaseAddress[31:19] . RW when Capability Offset 04h [Enable] = 0. RO when Capability Offset 04h [Enable] = 1. Reset 0_0000_0000_0000b. Specifies lower bits of the base address of the IOMMU control registers. Base Address[31:19] may be set to any value.
18:14	BaseAddress[18:14] . RW when Capability Offset 04h [Enable] = 0. RO when Capability Offset 04h [Enable] = 1. Reset 0_0000b. This field must be set to 0_0000b.
13:1	Reserved. Software must write zeros to this field and not rely on this field to return the value written when read.
0	Enable . RW1S. Reset 0b. 1 = IOMMU accepts memory accesses to the address specified in the Base Address Register. When Enable is written with a 1, all RW capability registers defined in Section 3.2 [IOMMU Base Capability Block Registers] are locked until the next system reset. <i>Note: BaseAddress may be changed and locked with the same write operation that sets Enable = 1b.</i>

Capability Offset 08h IOMMU Base Address High Register

This register specifies the upper 32 bits of the base address of the IOMMU control registers. This register is locked when IOMMU Base Address Low[Enable] is written with a 1b.

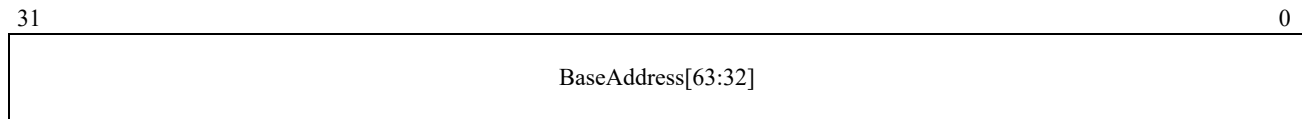

Bits	Description
31:0	BaseAddress[63:32] . RW when Capability Offset 04h[Enable] = 0. RO when Capability Offset 04h[Enable] = 1. Reset 0000_0000h. Specifies the upper 32 bits of the base address of the IOMMU control registers.

Capability Offset 0Ch IOMMU Range Register

This register indicates the device and function numbers of the first and last devices associated with the IOMMU. This register is locked when IOMMU Base Address Low[Enable] is written with a 1. Root port devices that have device and function numbers between the first and last device numbers inclusive are supported by the IOMMU and provide full source identification to the IOMMU. Non-root port devices that have device and function numbers between the first and last device numbers inclusive are devices integrated in with the IOMMU and support address translation using the IOMMU. Integrated devices associated with the IOMMU must be located on the same logical bus.

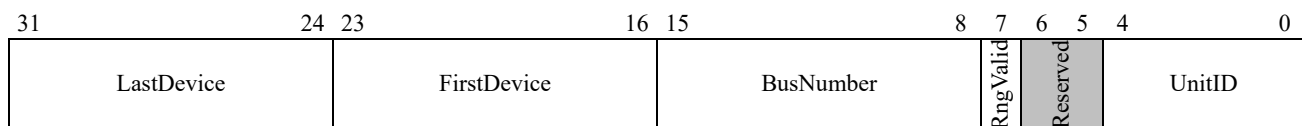

Bits	Description
31:24	LastDevice: Last device. RW when Capability Offset 04h[Enable] = 0. RO when Capability Offset 04h[Enable] = 1. Reset XXh. Indicates device and function number of the last integrated device associated with the IOMMU. <i>Note: an implementation may define this value as RO.</i>
23:16	FirstDevice: First device. RW when Capability Offset 04h[Enable] = 0. RO when Capability Offset 04h[Enable] = 1. Reset XXh. Indicates device and function number of the first integrated device associated with the IOMMU. <i>Note: an implementation may define this value as RO.</i>
15:8	BusNumber: Device range bus number. RW when Capability Offset 04h[Enable] = 0. RO when Capability Offset 04h[Enable] = 1. Reset XXh. Indicates the bus number that FirstDevice and LastDevice reside on. <i>Note: an implementation may define this value as RO.</i>

Bits	Description
7	RngValid: Range valid. RW when Capability Offset 04h[Enable] = 0. RO when Capability Offset 04h[Enable] = 1. Reset Xb. 1b = the BusNumber, FirstDevice, and LastDevice fields are valid. Although the register contents are valid, software is encouraged to use I/O topology information as defined in Chapter 5, "I/O Virtualization ACPI Table" . 0b = Software must use I/O topology information. <i>Note: an implementation may define this value as RO.</i>
6:5	Reserved.
4:0	UnitID: IOMMU HyperTransport™ UnitID. RW when Capability Offset 04h[Enable] = 0. RO when Capability Offset 04h[Enable] = 1. Reset X_XXXXb. This field returns the HyperTransport™ UnitID used by the IOMMU. <i>Note: an implementation may define this value as RO.</i> <i>Note: this field is deprecated and may be set to 0_0000b.</i>

Capability Offset 10h IOMMU Miscellaneous Information Register 0

This register returns the size of virtual and physical addresses supported by the IOMMU and the message number for MSI or MSI-X interrupts associated with the IOMMU.

31	27	26	23	22	21	15	14	8	7	5	4	0
MsiNumPPR	Reserved		HtAtsResv	VAsize			PAsize		GVAsize		MsiNum	

Bits	Description
31:27	MsiNumPPR: Peripheral Page Request MSI message number. RO. Reset X_XXXXb. This field must indicate which MSI/MSI-X vector is used for the interrupt message generated by the IOMMU for the peripheral page request log when MMIO Offset 0030h[PPRSup] = 1. MsiNumPPR must be zero when PPRSUp = 0. For MSI there can only be one IOMMU so this field must be zero (Section 3.1 [PCI Resources]). For MSI-X, the value in this field indicates which MSI-X Table entry is used to generate the interrupt message. Either MSI or MSI-X must be implemented, but not both. This interrupt is not remapped by the IOMMU. If neither MSI nor MSI-X are enabled and a PPR interrupt occurs, the interrupt is silently dropped. Implementation Note: INTx is not supported for the PPR interrupt.
26:23	Reserved.
22	HtAtsResv: ATS response address range reserved. RW when Capability Offset 04h[Enable] = 0b. RO when Capability Offset 04h[Enable] = 1b. Reset 0b. 1= The HyperTransport™ Address Translation address range for ATS responses is reserved and cannot be translated by the IOMMU. 0= The Address Translation address range can be translated by the IOMMU. See Table 3 on page 51 . <i>Implementation Note: This bit may be RO if ATS is not supported.</i>

Bits	Description
21:15	<p>VAsize: Virtual Address size. RO. Reset XXXXXXb. This field must indicate the size of the maximum virtual address processed by the IOMMU. The value is the (unsigned) binary log of the maximum address size. Allowed values are 32, 40, 48, and 64; all other values are reserved.</p> <p>010_0000b = 32 bits 010_1000b = 40 bits 011_0000b = 48 bits 100_0000b = 64 bits</p> <p>If guest translation is supported, this field defines the size of the GPA.</p>
14:8	<p>PAsize: Physical Address size. RO. Reset XXXXXXb. This field indicates the width of the maximum system physical address (SPA) generated by the IOMMU. The value is the (unsigned) binary log of the maximum address size. Allowed values are 40, 48, and 52; all other values are reserved.</p> <p>010_1000b = 40 bits 011_0000b = 48 bits 011_0100b = 52 bits</p>
7:5	<p>GVAsize: Guest Virtual Address size. RO. Reset XXXb. This field must indicate the size of the maximum guest virtual address processed by the IOMMU. The allowed size is 48 and all other values are reserved.</p> <p>000b - 001b = Reserved. 010b = 48 bits 011b = 57 bits 100b - 111b = Reserved</p>
4:0	<p>MsiNum: MSI message number. RO. Reset XXXXXXb. This field must indicate which MSI/MSI-X vector is used for the interrupt message generated by the IOMMU for the IOMMU event log.</p> <p>For MSI there can only be one IOMMU so this field must be zero (Section 3.1 [PCI Resources]).</p> <p>For MSI-X, the value in this field indicates which MSI-X Table entry is used to generate the interrupt message. Either MSI or MSI-X must be implemented, but not both. This interrupt is not remapped by the IOMMU.</p> <p>Implementation Note: <i>INTx is supported for backwards compatibility with the legacy implementation of the IOMMU, but its use is discouraged in designs.</i></p>

Capability Offset 14h IOMMU Miscellaneous Information Register 1

This register provides information about IOMMU extended capabilities. If [Capability Offset 00h\[Ext-Cap\]](#) = 1, the contents of this register are valid. If [Capability Offset 00h\[ExtCap\]](#) = 0, this register is reserved.

31	19 18	14 13	5 4	0
Reserved				MsiNumGA

Bits	Description
31:5	Reserved
4:0	MsiNumGA : MSI message number. RO. Reset XXXXXb. Message number for MSI or MSI-X interrupt associated with the guest vAPIC virtual interrupt request log (GA Log). If GA logging is supported (as indicated by MMIO Offset 0030h[GASup] = 1), Capability Offset 00h[ExtCap] will be set and this field will contain valid data.

3.3 IOMMU Vendor Specific Capability Block Registers

The IOMMU Vendor Specific capability is a capability structure in PCI 3.0 compatible Configuration Space. The presence of an IOMMU Vendor Specific capability block contains various registers to control the vIOMMU.

Vendor Specific Capability Offset 00h IOMMU Vendor Specific Capability Header

This is the first register of the IOMMU vendor specific capability block and provides information about vendor specific capabilities that IOMMU supports.

31	24 23	16 15	8 7	0
CapType	CapLen	CapPtr	CapID	

Bits	Description
31:24	CapType: IOMMU vendor specific capability block type. RO. Reset 01h.
23:16	CapLen: Capability length. RO. Reset XXh. Indicate the length of this vendor specific capability block in number of bytes.
15:8	CapPtr: Capability Pointer. RO. Reset XXh. Indicates the location of the next capability block, or 00h if this is the last capability block in the capability list.
7:0	CapID: Capability ID. RO. Reset 09h. Indicates a Vendor-Specific Capability block.

Vendor Specific Capability Offset 04h IOMMU Vendor Specific Capability Info

This register specifies the ID and the Revision of the IOMMU Vendor Specific Capability Block.

31	24 23	16 15	8 7	0
Reserved	VSC_Rev	VSC_ID		

Bits	Description
31:24	Reserved
23:16	VSC_Rev: Vendor specific capability revision. RO. Reset 0h.
15:0	VSC_ID: Vendor specific capability ID. RO. Reset 00h.

The registers specified below are the base address (SPA) of the IOMMU Virtual Function MMIO area. The area must be 256M aligned.

Vendor Specific Capability Offset 08h IOMMU Virtual Function Base Address Low Register

31:28 – VF_BaseAddress[31:28]	27:1 – Reserved
	0 – VF_Enable

31:28 VF_BaseAddress[31:28]. RW when Capability 110h [VF_Enable] = 0. RO when Capability 110h [VF_Enable] = 1. Reset 0000b. Specifies the lower bits of the base address of the IOMMU Virtual Function MMIO region.

0 VF_Enable. RW1S. Reset 0b. 1 = IOMMU accepts memory accesses to the address specified in the VF_BaseAddress field. Lock VF_BaseAddress once this bit is set.

Vendor Specific Capability Offset 0Ch IOMMU Virtual Function Base Address High Register

31:0 – VF_BaseAddress[63:32]

31:0 VF_BaseAddress[63:32]. RW when Capability 110h [VF_Enable] = 0. RO when Capability 110h [VF_Enable] = 1. Reset 0000_0000h. Specifies the upper bits of the base address of the IOMMU Virtual Function MMIO region.

The registers specified below are the base address (SPA) of the IOMMU Virtual Function Control MMIO area. The area must be 4M aligned.

Vendor Specific Capability Offset 10hIOMMU Virtual Function Control Base Address Low Register

31:22 – VFCntl_BaseAddress[31:22]	21:1 – Reserved 0 – VFCntl_Enable
-----------------------------------	--------------------------------------

31:22 VFCntl_BaseAddress[31:22]. RW when Capability 118h [VFCntl_Enable]=0. RO when Capability 118h [VFCntl_Enable] = 1. Reset 00_0000_0000b. Specifies the lower bits of the base address of the IOMMU Virtual Function Control MMIO region.

0 VFCntl_Enable. RW1S. Reset 0b. 1 = IOMMU accepts memory accesses to the address specified in the VFCntl_BaseAddress field. Lock VFCntl_BaseAddress once this bit is set.

Vendor Specific Capability Offset 14hIOMMU Virtual Function Control Base Address High Register

31:0 – VFCntl_BaseAddress[63:32]

31:0 VFCntl_BaseAddress[63:32]. RW when Capability 118h [VFCntl_Enable]=0. RO when Capability 118h [VFCntl_Enable] = 1. Reset 0000_0000h. Specifies the upper bits of the base address of IOMMU Virtual Function Control MMIO region.

3.4 IOMMU MMIO Registers

The IOMMU control registers are mapped using the [IOMMU Base Address Low Register \[Capability Capability Offset 04h\]](#) and [IOMMU Base Address High Register \[Capability Capability Offset 08h\]](#) specified in the IOMMU capability block. Software access to IOMMU registers may not be larger than 64 bits. Accesses must be aligned to the size of the access and the size in bytes must be a power of two. Software may use accesses as small as one byte.

3.4.1 Control and Status Registers

MMIO Offset 0000h Device Table Base Address Register

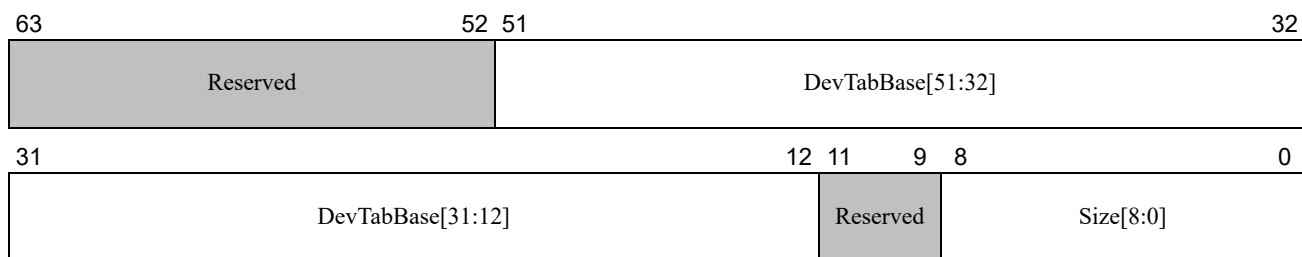

Bits	Description
63:52	Reserved.
51:12	DevTabBase: Device Table base address. RW. Reset 00_0000_0000h. Specifies bits [51:12] of the 4-Kbyte aligned base address of the first level Device Table.
11:9	Reserved.
8:0	Size: Size of the Device Table. RW. Reset 000h. This field contains an unsigned value n that specifies the size of the Device Table. The size indicated is $(n + 1) * 4$ Kbytes. For example, the value 0 corresponds to a table size of 4 Kbytes and the value of 1FFh (the maximum that can be specified) corresponds to a table size of 2 Mbytes.

If device table segmentation is not supported or not enabled, this register establishes the base address of the single, unified Device Table. When device table segmentation is supported and enabled, this register serves as the base address register for segment 0 of the Device Table.

MMIO Offset 0008h Command Buffer Base Address Register

This register specifies the system physical address and length of the command buffer.

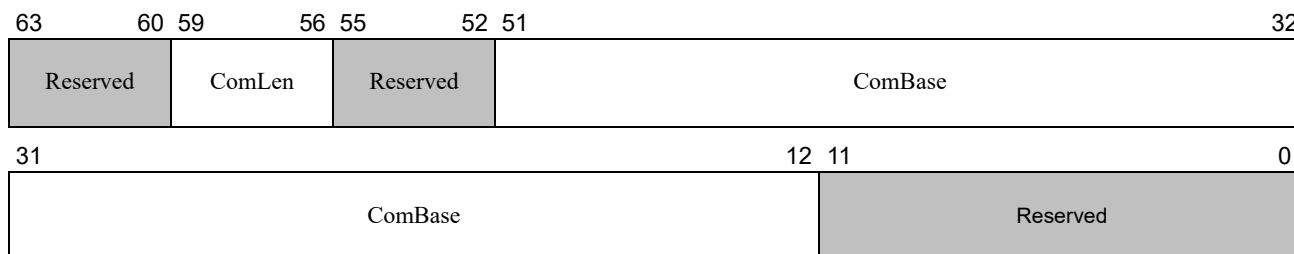

Bits	Description
63:60	Reserved.
59:56	ComLen: Command buffer length. RW. Reset 1000b. Specifies the length of the command buffer in power-of-2 increments. The minimum size is 256 entries (4 Kbytes); values less than 1000b are reserved. 0000b - 0111b = Reserved 1000b = 256 entries (4 Kbytes) 1001b = 512 entries (8 Kbytes) ... 1111b = 32768 entries (512 Kbytes)
55:52	Reserved
51:12	ComBase: Command buffer base address. RW. Reset 00_0000_0000h. Specifies bits [51:12] of the base address of the command buffer. The base address must be aligned to 4 Kbytes.
11:0	Reserved

MMIO Offset 0010h Event Log Base Address Register

This register specifies the system physical address and length of the event log.

Software Note: If *EventLen* or *EventBase* is changed while the *EventLogRun* = 1, the IOMMU behavior is undefined.

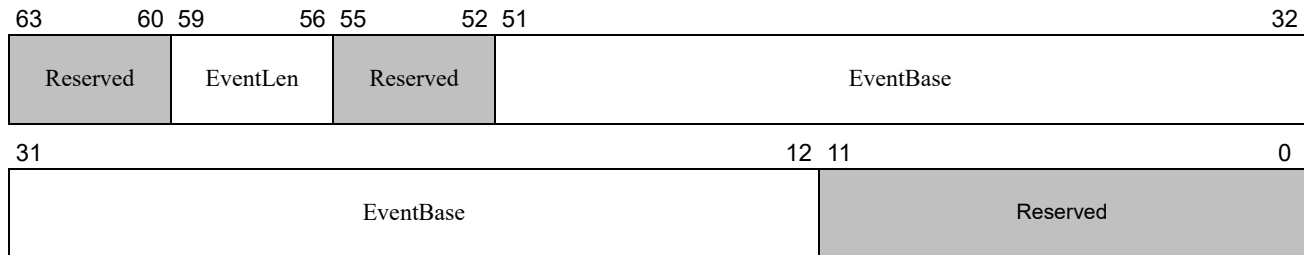

Bits	Description
63:60	Reserved.
59:56	EventLen: Event log length. RW. Reset 1000b. Specifies the length of the event log in power of 2 increments. The minimum size is 256 entries (4 Kbytes); values less than 1000b are reserved. 0000b - 0111b = Reserved 1000b = 256 entries (4 Kbytes) 1001b = 512 entries (8 Kbytes) ... 1111b = 32768 entries (512 Kbytes)
55:52	Reserved
51:12	EventBase: Event log base address. RW. Reset 00_0000_0000h. Specifies bits [51:12] of the base address of the event log. The base address must be aligned to 4 Kbytes.
11:0	Reserved

MMIO Offset 0018h IOMMU Control Register

This register controls the behavior of the IOMMU.

63	61	60	59	58	57	56	55	54	53	52	51	50	49	48	47	46	45	44	43	42	41	40	39	38	37	36	34	33	32
SNPAVICEn	GstBufferTRPMode	IRTCacheDis	GCR3TRPMode	Reserved	GAPPIEn	GAUpdateDis	viommuEn	vCmdEn	IntCapXTEn	XTEn	Reserved	GDUpdateDis	HADUpdate	EPHEn	Reserved	PprAutoRspAon	BlkStopMrkEn	MarcEn	PprAutoRspEn	PrivAbrtEn	DevTblSegEn	DualEventLogEn							
31	30	29	28	27	25	24	23	22	21	18	17	16	15	14	13	12	11	10	9	8	7	5	4	3	2	1	0		
DualPprLogEn	GAIntEn	GALogEn	GAMEn	SmIFLogEn	SIWBadis	SmIFEn	CRW	GAEn	GTEn	PPREn	PprIntEn	PPRLogEn	CmdBufEn	Isoc	Coherent	ResPassPW	PassPW	InvTimeOut	ComWaitIntEn	EventIntEn	EventLogEn	HtTunEn	IommuEn						

Bits	Description
63:61	<p>SNPAVICEn: Controls guest virtual APIC mode when the system is SNP-enabled. Supported modes are indicated through MMIO Offset 01A0h[SNPAVICSup].</p> <p>000b = Interrupt remapping behavior as defined in Section 2.2.5.2, “Interrupt Virtualization Tables with Guest Virtual APIC Enabled” on page 90. Upstream interrupts are remapped using the IRTE entries defined by Figure 17 on page 92 and Table 22 on page 92</p> <p>001b-111b = Reserved.</p>
60	<p>GstBufferTRPMode: Controls how IOMMU computes the Base pointer of the vIOMMU accelerated Guest Buffers (Event, Command, PPR etc.) Software may detect the presence of this feature by checking that this register bit is writable.</p> <p>0 = IOMMU will calculate base address of vIOMMU Guest Buffer algorithmically in the IOMMU Private Space. The IOMMU Private PA will then be translated to System PA using IOMMU v1 page tables.</p> <p>1 = GuestX VF Control MMIO Offsets will contain Guest Physical Address of the buffers base address. See Section 3.5 [IOMMU Virtual Function Controls MMIO Registers].</p>
59	<p>IRTCacheDis: 1=Disable IRTE caching. When caching is disabled, software may modify IRTEs in memory without issuing INVALIDATE_INTERRUPT_TABLE commands. Writing this register to 1 does not invalidate prior cached IRTEs. Software must invalidate those using appropriate invalidation commands. Software may detect the presence of this feature by checking that this register bit is writable.</p>
58	<p>GCR3TRPMode:</p> <p>0: GCR3 Table Root Pointer inside DTE is System Physical Address.</p> <p>1: GCR3 Table Root Pointer inside DTE is Guest Physical Address. The GPA must be translated by IOMMU using nested page tables to system physical addresses.</p> <p>See Section 2.2.3 [I/O Page Tables for Host Translations].</p>
57:56	Reserved.

Bits	Description
55	GAPPIEn: Guest APIC Physical Processor Interrupt Enable. RW. Reset: 0b. 1= Writing to the GALog when handling a guest interrupt to a non-running guest may be selectively suppressed on a per-IRTE basis. 0 = Guest interrupts to non-running guests are recorded in GALog entries. See Section 2.2.5.4 [Guest APIC Physical Processor Interrupt] on page 96.
54	GAUpdateDis: Disable hardware update access bit in guest page table.
53	vIommuEn: Enable virtualized IOMMU.
52	vCmdEn: Enable virtualized command buffer processing.
51	IntCapXTEn: Enable IOMMU x2APIC interrupts generation. When MMIO Offset 0030h[XTSup]=0, this field is reserved.
50	XTEn: Enable X2APIC. When MMIO Offset 0030h[XTSup]=0, this field is reserved.
49	Reserved.
48	GDUpdateDis: Disable hardware updating dirty bit in guest page table.
47:46	HADUpdate: Access and Dirty bit update in host page table.
45	EPHEN: Enhanced Peripheral Page Request Handling.
44:43	Reserved.
42	PprAutoRspAon: Peripheral Page Request Auto Response – Always On feature enable. RW. Reset: 0b. 0 = PPR Auto Response – Always On feature is disabled. Enabling the PPR Auto Response – Always On feature requires setting this bit and PprAutoRspEn. When MMIO Offset 0030h[PprAutoRespSup] = 0, this field is reserved. See Section 2.6.4.4 [PPR Auto Response Always-on] on page 180.
41	BlkStopMrkEn. Block StopMark messages feature Enable RW. Reset: 1b. This feature, when supported, is enabled by default. When MMIO Offset 0030h[BlkStopMrkSup] = 0. this field is reserved. See Section 2.6.4.5 [Block StopMark Messages] on page 180.
40	MarcEn: Memory Address Routing and Control feature Enable. RW. Reset: 0b. 0 = MARC disabled. 1 = MARC is enabled. When MMIO Offset 0030h[MarcSup] = 00b, this field is reserved. See Section 2.9 [Memory Address Routing and Control (MARC)] on page 186.
39	PprAutoRspEn: Peripheral Page Request Automatic Response feature Enable. RW. Reset: 0b. 0 = PPR auto response is disabled. 1 = PPR auto response, if supported, is enabled. When MMIO Offset 0030h[PprAutoRespSup] = 0, this field is reserved. See Section 2.6.4.1 [PPR Auto Response] on page 179.
38:37	PrivAbtEn: Privilege abort enable. RW. Reset: 00b. 00b = IOMMU will abort any access request to a guest supervisor page when the PMR bit of the PCIe TLP prefix indicates a non-privileged (user mode) request. 01b = IOMMU will abort any access request to a guest supervisor page regardless of the setting of the PMR bit. Values 10b and 11b are reserved. When MMIO Offset 0030h[USSup] = 0, this field is reserved. See Section 2.2.6.2 [AMD64 Guest Page Table Access Protection] on page 97.
36:34	DevTblSegEn: Device Table Segmentation Enable. RW. Reset: 000b. 000b = Device Table is not segmented. 001b = Device Table divided into 2 segments. 010b = Device Table divided into 4 segments. 011b = Device Table divided into 8 segments. 100b–111b = Reserved. When MMIO Offset 0030h[DevTblSegSup] = 00b, this field is reserved. This field must not be set to a value greater than the value of DevTblSegSup. See Section 2.2.2.3 [Device Table Segmentation] on page 76.

Bits	Description
33:32	<p>DualEventLogEn: Dual Event Log Enable. RW. Reset: 00b. 00b = Use the default (A) Event Log buffer. 01b = Use the alternate (B) buffer. 10b = Automatically swap buffers as the currently active buffer becomes full. 11b = Reserved.</p> <p>Note: If the overflow bit of the buffer to be swapped to is set, event logging ceases. When MMIO Offset 0030h[DualEventLogSup] = 00b, this field is reserved. See Section 2.5.17 [Event Log Dual Buffering] on page 171.</p>
31:30	<p>DualPprLogEn: Dual Peripheral Page Request Log Enable. RW. Reset: 00b. 00b = Use the default (A) Peripheral Page Request Log. 01b = Use the alternate (B) Peripheral Page Request Log. 10b = Automatically swap logs as the currently active log becomes full. 11b = Reserved.</p> <p>Note: If the overflow bit of the log to be swapped to is set when a log swap about to occur, an error occurs. Note: If auto-response is enabled (auto-response is enabled if either bit 39 or 42 of the IOMMU Control Register [MMIO Offset 0018h] is set to 1), PprLogEn must not be set to 10b. When MMIO Offset 0030h[DualPPRLogSup] = 00b, this field is reserved. See Section 2.6.1 [PPR Log Dual Buffering] on page 174.</p>
29	<p>GAIntEn: Guest virtual APIC interrupt enable. RW. Reset 0b. 0 = An interrupt is not signalled when MMIO Offset 2020h[GALogInt] changes from 0 to 1. 1 = An interrupt is signaled when MMIO Offset 2020h[GALogInt] changes from 0 to 1 using Capability Offset 14h[MsiNumGA]. Writes to this bit are ignored when MMIO Offset 0030h[GASup] = 0.</p>
28	<p>GALogEn: Guest virtual APIC GA Log Enable. RW. Reset 0b. 0 = Disable guest vAPIC virtual interrupt request logging. (GA Logging). 1 = Enable GA Logging. See Section 2.7 [Guest Virtual APIC (GA) Logging]. Writes to this bit are ignored when MMIO Offset 0030h[GASup] = 0.</p>
27:25	<p>GAMEn: Guest virtual APIC mode enabled. RW. Reset 000b. This field specifies advanced interrupt behaviors and the size of the IRTE.</p> <p>000b = Interrupt remapping behavior as defined in Section 2.2.5.2 [Interrupt Virtualization Tables with Guest Virtual APIC Enabled]. Upstream interrupts are remapped using the IRTE entries defined by Figure 17 on page 92 and Table 22 on page 92.</p> <p>001b = Virtual interrupt behavior as defined by the Guest Virtual APIC specification in APM2 and Section 2.2.5.2 [Interrupt Virtualization Tables with Guest Virtual APIC Enabled]. Upstream interrupts are remapped using the IRTE entries defined by Figure 21 on page 91 and Table 23 on page 94.</p> <p>010b-111b = reserved values. Writes to this field are ignored when MMIO Offset 0030h[GASup] = 0.</p>
24	<p>SmiFLogEn: SMI filter log enable. RW. Reset 0b. Defines if SMI interrupts blocked by the SMI filter are logged by the IOMMU.</p> <p>0 = SMI interrupts blocked by the SMI filter are not logged. 1 = SMI interrupts blocked by the SMI filter are reported in the IOMMU event log. See also Section 2.5.3 [IO_PAGE_FAULT Event].</p> <p>Note: SmiFLogEn controls event log entry creation by the SMI filter; the SA, SE, IG, and SupIOPF bits operate independently on interrupts processed through the interrupt remapping filter (see Table 7 on page 64 and Table 20 on page 89).</p> <p>When MMIO Offset 0030h[SmiFSup] = 0b, this bit is ignored by hardware and may be implemented as a read-only value of 0b.</p>

Bits	Description
23	SlfWBdis : Self Writeback Disable.
22	SmiFEn : SMI filter enable. Defines how SMI interrupts are handled by the IOMMU. 0 = SMI interrupts are always passed upstream without modification. 1 = SMI interrupts are blocked unless otherwise controlled by the SMI filter registers. Blocked SMI interrupts are reported in the IOMMU event log as governed by SmiFLogEn. See also Section 2.1.5.1 [SMI Filter Operation] . When MMIO Offset 0030h[SmiFSup] = 0b, SmiFEn is ignored by hardware and may be implemented as a read-only value of 0b.
21:18	CRW : RO. Reset 0h. Reserved. Intended for future use. Software Note : Software may safely write 0h to this field, but should ignore the value read.
17	GAEn : Guest virtual APIC enable. RW. Reset 0b. 0 = Guest virtual APIC feature for device interrupt virtualization is not enabled. 1 = device interrupts are updated using the Guest Virtual APIC Table Root Pointer in the DTE and are posted to the processors. Writes to this bit are ignored when MMIO Offset 0030h[GASup] = 0. See Section 1.3.7 [AMD64 Interrupt Virtualization(Guest Virtual APIC Interrupt Controller)] .
16	GTEn : Guest translation enable. RW. Reset 0b. 0 = Guest translation disabled. 1 = Guest translation may be enabled for a peripheral by programming DTE[GV] (see Table 7 on page 64). When guest translation is enabled, invalidation semantics are changed (see Section 1.3.2 [Enhanced Processor Page Table Compatibility]). Writes to this bit are ignored when MMIO Offset 0030h[GTSup] = 0.
15	PPREn : Peripheral page request processing enable. RW. Reset 0b. 1 = Peripheral page requests are processed. 0 = PPR requests are treated as invalid device requests (see Section 2.5.9 [INVALID_DEVICE_REQUEST Event]). Writes to this bit are ignored when MMIO Offset 0030h[PPRSup] = 0.
14	PprIntEn : Peripheral page request interrupt enable. RW. Reset 0b. 1 = An interrupt is signalled when MMIO Offset 2020h[PPRLogInt] = 1 using Capability Offset 10h[MsiNumPPR] . 0 = An interrupt is not signalled when MMIO Offset 2020h[PPRLogInt] = 1. Writes to this bit are ignored when MMIO Offset 0030h[PPRSup] = 0.
13	PPRLogEn : Peripheral page request log enable. RW. Reset 0b. 1 = The PPR Log Base Address Register [MMIO Offset 0038h] has been configured and peripheral page request events are written to the peripheral page request log when IommuEn has also been set. Writing a 1 to this bit when MMIO Offset 2020h[PPRLogRun] = 1b has no effect. 0 = Peripheral page request logging is not enabled. Peripheral page requests are discarded when the peripheral page request log is not enabled or when MMIO Offset 0030h[PPRSup] = 0. When IommuEn = 1b and PPREn = 1b, if software writes PPRLogEn with 1b, the IOMMU clears the PPRLogOverflow bit and sets the PPRLogRun bit in the IOMMU Status Register [MMIO Offset 2020h] . The IOMMU can now write new entries to the event log if there are usable entries available. Note : writes to this bit are ignored when MMIO Offset 0030h[PPRSup] = 0. Software Note : software can read MMIO Offset 2020h[PPRLogRun] to determine the status of peripheral page request log writing by the IOMMU. Note : the peripheral page request log and event log are independent. Software Note : the PPR Log Base Address Register [MMIO Offset 0038h], the IOMMU PPR Log Head Pointer Register [MMIO Offset 2030h], and the IOMMU PPR Log Tail Pointer Register [MMIO Offset 2038h] must be set prior to enabling the event log.

Bits	Description																
12	<p>CmdBufEn: Command buffer enable. RW. Reset 0b. 1 = Start or restart command buffer processing. When CmdBufEn = 1b and IommuEn = 1b, the IOMMU starts fetching commands and sets MMIO Offset 2020h[CmdBufRun] to 1b. Writing a 1b to CmdBufEn when CmdBufRun = 1b has no effect. 0 = Halt command buffer processing. Writing a 0 to CmdBufEn causes the IOMMU to cease fetching new commands although commands previously fetched are completed. The IOMMU stops fetching commands upon reset and after events as specified in Section 2.5 [Event Logging]. See MMIO Offset 2020h[CmdBufRun].</p> <p><i>Note:</i> see IOMMU Status Register [MMIO Offset 2020h] to determine the status of command buffer processing.</p> <p>Note: writing of event log entries is independently controlled by EventLogEn.</p> <p>Software Note: the Command Buffer Base Address Register [MMIO Offset 0008h], the Command Buffer Head Pointer Register [MMIO Offset 2000h], and the Command Buffer Tail Pointer Register [MMIO Offset 2008h] must be set prior to enabling the IOMMU command buffer processor.</p>																
11	<p>Isoc: Isochronous. RW. Reset 0b. This bit controls the state of the isochronous bit in the HyperTransport™ read request packet when the IOMMU issues I/O page table reads and Device Table reads on the HyperTransport™ link. 1 = Request packet to use isochronous channel. 0 = Request packet to use standard channel.</p> <p><i>Note:</i> Platform firmware should set this bit to 1b for processors that support the isochronous channel.</p>																
10	<p>Coherent:: Coherent. RW. Reset 1b. This bit controls the state of the coherent bit in the HyperTransport™ read request packet when the IOMMU issues Device Table reads on the HyperTransport™ link. 1 = Device table requests are snooped by the processor. 0 = Device table requests are not snooped by the processor. See SD in Table 7 on page 64.</p>																
9	<p>ResPassPW: Response pass posted write. RW. Reset 0b. This bit controls the state of the ResPassPW bit in the HyperTransport™ read request packet when the IOMMU issues I/O page table reads and Device Table reads on the HyperTransport™ link. 1 = Response may pass posted requests. 0 = Response may not pass posted requests.</p>																
8	<p>PassPW: Pass posted write. RW. Reset 0b. This bit controls the state of the PassPW bit in the HyperTransport™ read request packet when the IOMMU issues I/O page table reads and Device Table reads on the HyperTransport™ link. 1 = Request packet may pass posted requests. 0 = Request packet may not pass posted requests.</p>																
7:5	<p>InvTimeOut: Invalidation time-out. RW. Reset 000b. This field specifies the invalidation time-out for IOTLB invalidation requests.</p> <table border="0"> <tr> <td>000b</td> <td>No time-out</td> <td>001b</td> <td>1 ms</td> </tr> <tr> <td>010b</td> <td>10 ms</td> <td>011b</td> <td>100 ms</td> </tr> <tr> <td>100b</td> <td>1 sec.</td> <td>101b</td> <td>10 sec.</td> </tr> <tr> <td>110b</td> <td>100 sec.</td> <td>111b</td> <td>reserved</td> </tr> </table>	000b	No time-out	001b	1 ms	010b	10 ms	011b	100 ms	100b	1 sec.	101b	10 sec.	110b	100 sec.	111b	reserved
000b	No time-out	001b	1 ms														
010b	10 ms	011b	100 ms														
100b	1 sec.	101b	10 sec.														
110b	100 sec.	111b	reserved														
4	<p>ComWaitIntEn: Completion wait interrupt enable. RW. Reset 0b. 1 = An interrupt is signalled when MMIO Offset 2020h[ComWaitInt] = 1 using Capability Offset 10h[MsiNum].</p>																
3	<p>EventIntEn: Event log interrupt enable. RW. Reset 0b. 1 = An interrupt is signalled when MMIO Offset 2020h[EventLogInt] = 1 or when MMIO Offset 2020h[EventOverflow] = 1 using Capability Offset 10h[MsiNum].</p>																

Bits	Description
2	<p>EventLogEn: Event log enable. RW. Reset 0b. 1 = The Event Log Base Address Register [MMIO Offset 0010h] has been configured and all events detected are written to the event log when IommuEn has also been set. Writing a 1b to this bit when EventLogEn = 1b has no effect. 0 = Event logging is not enabled. Events are discarded when the event log is not enabled.</p> <p>When IommuEn = 1b and software changes EventLogEn from 0b to 1b, the IOMMU clears the EventOverflow bit and sets the EventLogRun bit in the IOMMU Status Register [MMIO Offset 2020h]. The IOMMU can now write new entries to the event log if there are usable entries available.</p> <p>Software Note: software can read MMIO Offset 2020h[EventLogRun] to determine the status of event log writing by the IOMMU.</p> <p>Note: the fetching of commands is independently controlled by CmdBufEn.</p> <p>Software Note: the Event Log Base Address Register [MMIO Offset 0010h], the Event Log Head Pointer Register [MMIO Offset 2010h], and the Event Log Tail Pointer Register [MMIO Offset 2018h] must be set prior to enabling the event log.</p>
1	<p>HtTunEn: HyperTransport™ tunnel translation enable. RW. Reset 0b. 1 = Upstream traffic received by the HyperTransport™ tunnel is translated by the IOMMU. 0 = Upstream traffic received by the HyperTransport™ tunnel is not translated by the IOMMU. The IOMMU ignores the state of this bit while IommuEn = 0. See the HtTunnel bit in the IOMMU Capability Header [Capability Offset 00h].</p>
0	<p>IommuEn: IOMMU enable. RW. Reset 0b.</p> <p>1 = IOMMU enabled. All upstream transactions are processed by the IOMMU. The Device Table Base Address Register [MMIO Offset 0000h] must be configured by software before setting this bit.</p> <p>0 = IOMMU is disabled and no upstream transactions are translated or remapped by the IOMMU. When disabled, the IOMMU reads no commands and creates no event log entries.</p>

MMIO Offset 0020h IOMMU Exclusion Base Register / Completion Store Base Register

This register specifies the base DVA of the IOMMU exclusion range. Device accesses that target addresses in the exclusion range are neither translated nor access checked if the EX bit in the Device Table is set for the device or if the Allow bit is set in this register. Note that the exclusion range test is not applied to device transactions presenting a valid PASID TLP Prefix.

A translation request for which the IOMMU exclusion range applies and I = 1b in the Device Table entry returns R = 1, W = 1, and a physical address that equals the requested virtual address. The response to a multi-page translation request in the IOMMU exclusion range is implementation-specific.

Software Note: A peripheral using a remote IOTLB may cache the results of a translation request to the exclusion range, so an `INVALIDATE_IOTLB_PAGES` command must be issued after changing the IOMMU exclusion range.

63	52 51	32
Reserved	Exclusion Base Address[51:32]	
31	12 11	2 1 0
Exclusion Base Address[31:12]		Reserved
		Allow ExEn

Bits	Description
63:52	Reserved.
51:12	Exclusion range base address. RW. Reset 00_0000_0000h. Specifies bits [51:12] of the 4Kbyte-aligned base address of the exclusion range. When the system is SNP-enabled, the contents of the Exclusion range base address field are locked and repurposed as the Completion store base address field. This contains bits [51:12] of the 4Kbyte-aligned base address that defines the starting address range that host COMPLETION_WAIT stores may target.
11:2	Reserved.
1	Allow: Allow all devices. RW. Reset 0b. 1 = All accesses to the exclusion range are forwarded untranslated. 0 = The EX bit in the Device Table entry specifies if accesses to the exclusion range are translated. This field must be set to 0 prior to and after making the system SNP-enabled.
0	ExEn: Exclusion range enable. RW. Reset 0b. 1 = The exclusion range is enabled. 0 = the exclusion range is disabled. This field must be set to 0 prior to and after making the system SNP-enabled.

MMIO Offset 0028h IOMMU Exclusion Range Limit Register / Completion Store Limit Register

This register specifies the limit of the IOMMU exclusion range. The lower 12 bits of the limit are treated as FFFh for range comparisons.

Note: When the exclusion base address equals the exclusion limit address, the exclusion range is 4 KB.

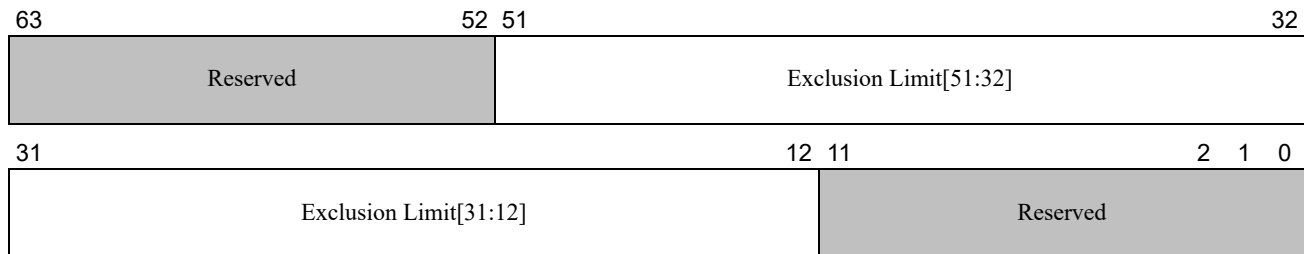

Bits	Description
63:52	Reserved.
51:12	Exclusion range limit. RW. Reset 00_0000_0000h. Specifies bits [51:12] of the upper limit of the exclusion range. When the system is SNP-enabled, the contents of the Exclusion range limit field are locked and repurposed as the Completion store limit field. Bits 11:0 of the completion store limit address are treated as F_FFh. The completion store limit address defines the upper address range that host COMPLETION_WAIT stores may target.
11:0	Reserved.

MMIO Offset 0030h IOMMU Extended Feature Register

This register specifies the extended features supported by the IOMMU.

Note: when *Capability Offset 00h*[EFRSup] = 0b, this register is reserved and the features described by it are not supported by the IOMMU.

63	62	61	60	56	55	54	53	52	51	50	49	48	47	46	45	44	43	42	41	40	39	38	37	36									32
SNPSup	ForcePhyDestSup	GAUpdateDisSup	Reserved				vIommuSup	InvIotlbTypeSup	Reserved	HDSup	AttrFWSup	EPHSup	HASup	GIOSup	Reserved	MsiCapMmioSup	PerfOptSup	BlkStopMrkSup	MarcSup	PPRAutoRspSup	PPREarlyOFSup	DevTblSegSup	USup	PASmax[4:0]									
31	30	29	28	27	26	25	24	23	21		20	18		17	16	15	14	13	12	11	10	9	8	7	6	5	4	3	2	1	0		
SATSSup	Reserved	DualEventLogSup	Reserved		DualPprLogSup	GAMSup			SmiFRC		SmiFSup		GLXSup		GATS		HATS		PCSup	HESup	GASup	IASup	GAPPIISup	GTSup	NXSup	XTSup	PPRSup	PreFSup					

Bits	Description
63	SNPSup: Secure Nested Paging support. RO. 1=SEV-SNP supported 0=SEV-SNP not supported SEV-SNP is only supported at the system level if both the CPU and IOMMU support the feature.
62	ForcePhyDestSup: Force Physical Destination Mode for Remapped Interrupt Support. RO. 1= feature supported. 0 = feature not supported. When this bit is set, OS or host must program the DM bit to 0b in the IRTE and program the destination field to the physical APIC ID of the thread to which the interrupt should be delivered.
61	GAUpdateDisSup: Support disabling hardware update on guest page table access bit. RO. 1= feature supported. 0 = feature not supported.
60:56	Reserved.
55	vIommuSup: virtualized IOMMU support. RO. 1=feature supported. 0=feature not supported.
54	InvIotlbTypeSup: Invalidate IOTLB Type Support. RO. 1=feature supported. 0=feature not supported. See Section 2.4.4 INVALIDATE_IOTLB_PAGES.
53	Reserved.
52	HDSup: Host Dirty Support. RO. 1 = feature supported. 0 = feature not supported. See Section 2.2.3.2 [Host Dirty Support] on page 86. The Host Access feature must be supported if the IOMMU supports the Host Dirty feature.
51	AttrFWSup: Attribute Forward Support. RO. 1=feature supported. 0=feature not supported. See Section 2.2.7.11 Extended Coherency Attributes.
50	EPHSup: Enhanced PPR Handling Support. RO. 1=feature supported. 0=feature not supported. See Section 2.6.4.1 PPR Auto Response and Section 2.5.10 INVALID_PPR_REQUEST.
49	HASup: Host Access Support. RO. 1 = feature supported. 0 = feature not supported. See Section 2.2.3.1 [Host Access Support] on page 85.

Bits	Description
48	GIOSup: Guest I/O Protection Support. RO. 1= feature supported. 0 = feature not supported. See Section 2.2.7.9 [Calculating Non-Snoop Accesses Attribute for an ATS Response] on page 117.
47	Reserved.
46	MsiCapMmioSup: MSI Capability Register MMIO access Support. RO. 1 = feature supported. 0 = feature not supported. See Section 3.4.8 [MMIO Access to MSI Capability Block Registers] on page 230.
45	PerfOptSup: IOMMU performance optimization feature. RO. 1 = feature supported. 0 = feature not supported. See IOMMU Performance Optimization Control Register [MMIO Offset 016Ch] .
44	BlkStopMrkSup: Block StopMark messages feature Support. RO. 1 = feature is supported. 0 = feature is not supported.
43:42	MarcSup: Memory Access Routing and Control feature support. RO. Specifies the number of MARC apertures and thus the number of MARC register 3-tuples supported. 00b = MARC feature not supported. 01b = Four MARC register 3-tuples are supported. 10b = Eight MARC register 3-tuples are supported. 11b = Reserved.
41	PPRAutoRspSup: PPR Automatic Response Support. RO. 1 = feature is supported. 0 = feature is not supported.
40	PprOvrflwEarlySup: PPR Log Overflow Early Warning Support. RO. 1 = feature is supported. 0 = feature is not supported.
39:38	DevTblSegSup: Segmented Device Table feature support. RO. Specifies the number of IOMMU Device Table segments supported. Number of Device Table segments supported = $2^{\text{DevTblSegSup}[1:0]}$.
37	USSup: 1 = User / supervisor page protection feature supported. 0 = feature not supported. See Section 2.2.6.2 [AMD64 Guest Page Table Access Protection] on page 97 for more information on this feature.
36:32	PASmax[4:0]: Maximum PASID supported. RO. Reset X_XXXXb. The maximum PASID value supported is equal to $2^{\text{PASmax}-1}$. 00h = 1-bit PASID 01h = 2-bit PASID 02h = 3-bit PASID 03h = 4-bit PASID 04h = 5-bit PASID 05h = 6-bit PASID 0Eh = 15-bit PASID 0Fh = 16-bit PASID 10h = 17-bit PASID 11h = 18-bit PASID 12h = 19-bit PASID 13h = 20-bit PASID 14h-1Fh = Reserved This value is not meaningful when MMIO Offset 0030h[GTSup] = 0.
31	SATSSup: Secure ATS Support. RO. Resert Xb. 1 = IOMMU supports processing ATS requests as either secure or non-secure ATS requests as controlled by DTE[SATS]. 0 = IOMMU does not support processing ATS requests as secure ATS requests.
30	Reserved.
29:28	DualEventLogSup: Dual Event Log Support. 00b = Event log dual buffer not supported. 01b = Event log dual buffer supported without autoswap. 10b = Event log dual buffer autoswap supported. 11b = Reserved.
27:26	Reserved.

Bits	Description
25:24	<p>DualPprLogSup: Dual PPR Log Support.</p> <p>00b = PPR log dual buffer not supported.</p> <p>01b = PPR log dual buffer supported without autoswap.</p> <p>10b = PPR log dual buffer autoswap supported.</p> <p>11b = Reserved.</p>
23:21	<p>GAMSup[2:0]: Guest virtual APIC modes supported. RO. Reset XXXb. Indicates the advanced virtual interrupt controller features supported.</p> <p>000b = No advanced interrupt features supported (interrupt remapping only).</p> <p>001b = Guest Virtual APIC supported.</p> <p>010b-111b = Reserved.</p> <p>See Table 21 on page 91 for activation controls.</p>
20:18	<p>SmiFRC[2:0]: SMI filter register count. RO. Reset XXXb. Indicates the number of SMI filter registers supported in hardware.</p> <p>000b = 1 filter register</p> <p>001b = 2 filter registers</p> <p>010b = 4 filter registers</p> <p>011b = 8 filter registers</p> <p>100b = 16 filter registers</p> <p>101b-111b = Reserved</p> <p>This value is not meaningful when MMIO Offset 0030h[SmiFSup] = 00b.</p>
17:16	<p>SmiFSup[1:0]: SMI filter register supported. RO. Reset XXb. Specifies that SMI interrupts may be filtered.</p> <p>00b = SMI interrupts are always passed-through. 01b = SMI interrupts are filtered under the control of MMIO Offset 0018h[SmiFEn] and the contents of the SMI filter registers. 10b and 11b are reserved values.</p>
15:14	<p>GLXSup: Guest CR3 root table level supported. RO. Reset XXb. Specifies the maximum number of levels supported in a guest CR3 root table. 00b = single-level Guest CR3 base table address translation is supported. 01b = Two-level GCR3 base address table is supported in hardware. 10b = Three-level GCR3 base address table is supported in hardware. 11b is reserved.</p> <p>The value of GLXSup is not meaningful when MMIO Offset 0030h[GTSup] = 0. See Table 11 on page 73.</p>
13:12	<p>GATS[1:0]: Guest Address Translation Size. RO. Reset XXb. The maximum number of translation levels supported for guest address translation (GVA). This value is not meaningful when MMIO Offset 0030h[GTSup] = 0.</p> <p>00b = 4 levels (PML4E)</p> <p>01b = 5 levels (PML5E)</p> <p>10b = 6 levels</p> <p>11b = Reserved</p> <p>See also Figure 33 on page 106 and Table 30 on page 106.</p>
11:10	<p>HATS[1:0]: Host Address Translation Size. RO. Reset XXb. The maximum number of host address translation levels supported.</p> <p>00b = 4 levels</p> <p>01b = 5 levels</p> <p>10b = 6 levels</p> <p>11b = Reserved</p> <p>This field sets an implementation limit on the value of DTE[Mode] in Table 7 on page 64 and sets an implementation limit on the value of Next Level in Figure 9 on page 80 and Figure 10 on page 82. See also Figure 40 on page 110.</p>
9	<p>PCSup: Performance counters supported. RO. Reset Xb. 0 = no performance counters are supported. 1 = performance counters are supported (see IOMMU Counter Configuration Register [MMIO Offset 4000h] and Section 3.4.22.1 [MMIO Event Counter Control Registers]).</p>

Bits	Description
8	HESup: Hardware Error registers supported. RO. Reset Xb. 0 = Hardware error registers do not report error information. 1 = Error information is reported in hardware error registers (see I/O Hardware Event Reporting Registers [2.5.16.2]).
7	GASup: Guest Virtual APIC Support. RO. Reset Xb. 1 = guest virtual APIC is supported. 0 = feature is not supported. See GAMSUp for modes supported. See MMIO Offset 0018h[GAEn] to enable the feature.
6	IASup: INVALIDATE_IOMMU_ALL supported. RO. Reset Xb. 1 = The INVALIDATE_IOMMU_ALL command is supported. 0 = The INVALIDATE_IOMMU_ALL command is not supported and will generate an error when used.
5	GAPPISup: Guest APIC Physical Processor Interrupt Support. RO. Reset Xb. 1 = Guest APIC Physical Interrupt feature is supported. 0 = Guest APIC Physical Interrupt feature is not supported.
4	GTSup: Guest translations supported. RO. Reset Xb. 1 = guest address translation is supported. 0 = only nested address translation is supported. When GTSup = 0, the following values in the DTE must be zero: GV, GLX, and GCR3 Table Root Pointer. See also MMIO Offset 0018h[GTEen] .
3	NXSup: EXE (PMR) and PRIV supported. RO. Reset Xb. 1 = no-execute protection (EXE, PMR) and privilege level are supported. 0 = no-execute protection (EXE, PMR) and privilege level are not supported. See Section 2.2.7.7 [PCIe® TLP PASID Prefix] .
2	XTSup: x2APIC support. RO. Reset Xb. 1 = the interrupt remapping table supports x2APIC. 0 = No x2APIC interrupt being supported.
1	PPRSup: Peripheral page request support. RO. Reset Xb. 1 = Indicates the IOMMU handles page service request events from peripherals, the IOMMU supports the page service request log, and that the second IOMMU interrupt can be used to signal peripheral page request events. 0 = peripheral page requests are not supported, the peripheral page request log is not supported, and the PPR interrupt is not generated by the IOMMU.
0	PreFSup: Prefetch support. RO. Reset Xb. 1 = Indicates IOMMU will accept PREFETCH_IOMMU_PAGES commands (see Section 2.4.6 [PREFETCH_IOMMU_PAGES]). 0 = IOMMU treats PREFETCH_IOMMU_PAGES commands as invalid commands.

3.4.2 PPR Log Registers

MMIO Offset 0038h PPR Log Base Address Register

This register specifies the system physical address and length of the peripheral page request log. Peripheral requests for page service handling are converted to entries in the PPR log.

This register is reserved when [Capability Offset 00h](#)[EFRSup] = 0b or when [MMIO Offset 0030h](#)[PPRSup] = 0b. Page service requests detected by the IOMMU are reported in the event log (see [Section 2.5.3 \[IO_PAGE_FAULT Event\]](#)).

If PPRLogLen or PPRLogBase is changed while the PPRLogRun = 1, the IOMMU response is undefined.

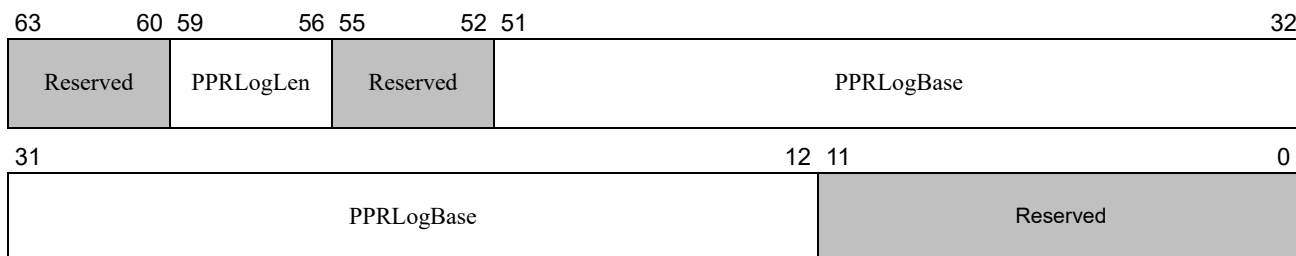

Bits	Description
63:60	Reserved.
59:56	PPRLogLen: Peripheral page request log length. RW. Reset 1000b. Specifies the length of the PPR log in power of 2 increments. The minimum size is 256 entries (4 Kbytes); values less than 1000b are reserved. 0000b - 0111b = Reserved 1000b = 256 entries (4 Kbytes) 1001b = 512 entries (8 Kbytes) ... 1111b = 32768 entries (512 Kbytes)
55:52	Reserved
51:12	PPRLogBase: Peripheral page request log base address. RW. Reset 00_0000_0000h. Specifies bits [51:12] of the base address of the PPR log. The base address must be aligned to 4 Kbytes.
11:0	Reserved

MMIO Offset 0040h IOMMU Hardware Event Upper Register

This register contains the upper 64-bits or the most recent hardware event detected by the IOMMU. If MMIO Offset 0030h[HESup] = 0, this and the following two registers are reserved.

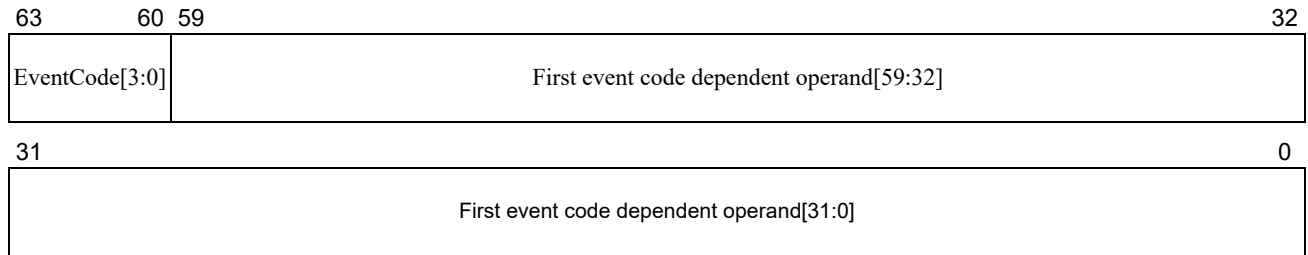

Bits	Description
63:60	EventCode[3:0] : RW. Reset 0000b. See Figure 54 on page 139 .
59:0	First event code dependent operand[59:0] : RW. Reset 000_0000_0000_0000h. See Figure 54 .

MMIO Offset 0048h IOMMU Hardware Event Lower Register

This register contains the lower 64-bits of the most recent hardware event detected by the IOMMU.

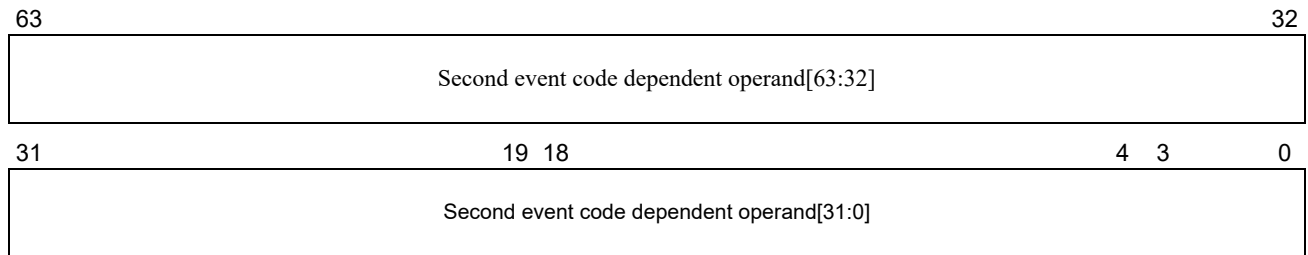

Bits	Description
63:0	Second event code dependent operand[59:0] : RW. Reset 0000_0000_0000_0000h. See Figure 54 on page 139 .

MMIO Offset 0050h IOMMU Hardware Event Status Register

This register contains information about the hardware event detected by the IOMMU.

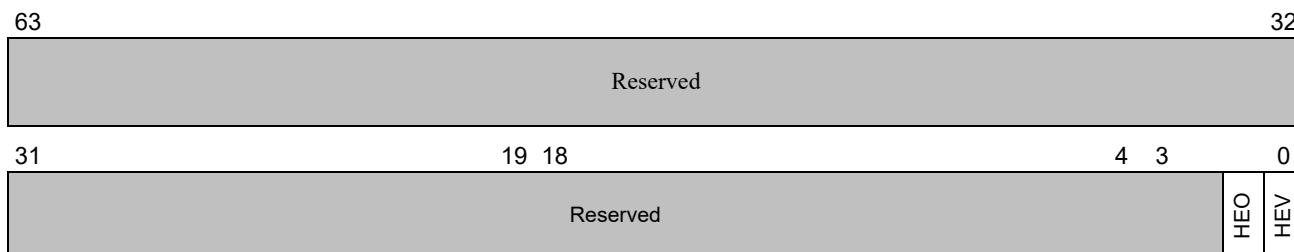

Bits	Description
63:2	Reserved.
1	HEO : Hardware Event Overflow. RW1C. Reset 0. 1 = The hardware event log has overflowed. An event was generated when HEV was already set to 1. The event information could not be stored in the hardware event registers.
0	HEV : Hardware Event Valid. RW1C. Reset 0. Defines the contents of the IOMMU hardware event registers as valid. 0 = register contents not valid. 1 = contents valid.

3.4.3 SMI Filter**MMIO Offset 00[60-D8]h IOMMU SMI Filter Register**

These registers filter the delivery of system management interrupts governed by [MMIO Offset 0018h\[SmiFEn\]](#) and [MMIO Offset 0030h\[SmiFSup\]](#). Information about a discarded SMI may be written to the event log as controlled by [MMIO Offset 0018h\[SmiFLogEn\]](#) (see [Section 2.5.3 \[IO_PAGE_FAULT Event\]](#)).

Up to 16 64-bit SMI filter registers are supported; the number of SMI filter registers implemented by the hardware is reported in [MMIO Offset 0030h\[SmiFRC\]](#). Unimplemented registers beyond those specified by SmiFRC return 0 when read and written data is ignored. SMI filter register 0 is the first implemented register, if any. All implemented SMI filter registers have the same behavior and are contiguous (see [Table 77](#)).

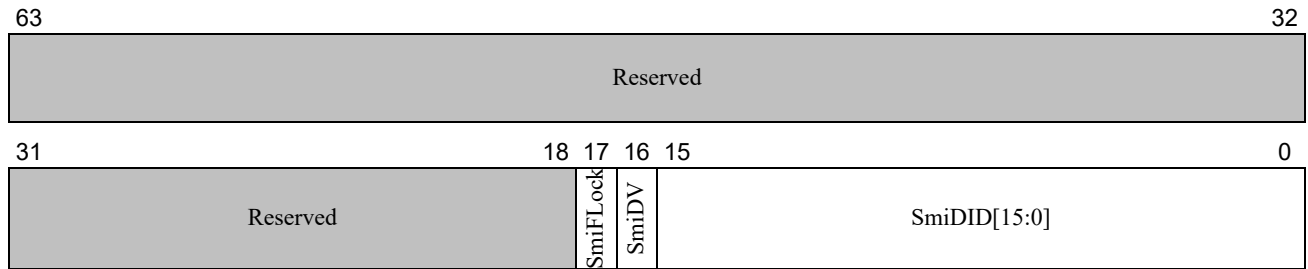

Bits	Description
63:18	Reserved.
17	SmiFLock : SMI filter lock. RW. Reset 0b. Locks the value of the containing SMI filter register. 0b = other fields in the SMI filter register can be read and written. 1b = all fields of the containing SMI filter register are read-only. Once written to a 1b, SmiFLock can only be changed to 0b by a system reset.
16	SmiDV : SMI device ID valid. RW. Reset 0b. Indicates that SmiDID is valid for matching purposes. 0b = SmiDID is not valid and any match results are ignored. 1b = SmiDID is a valid DeviceID and a comparison of SmiDID with the SMI interrupt DeviceID is meaningful. This bit is locked read-only by SmiFLock.
15:0	SmiDID[15:0] : SMI device ID. RW. Reset 0000h. Treated as a DeviceID when SmiDV indicates the field is valid. When SMI filtering is enabled for the containing SMI filter register, the SmiDID is compared to the DeviceID of an incoming SMI interrupt. When they match, the SMI interrupt is passed upstream without change. If none of the SMI filter registers indicate a valid match of the DeviceID of an upstream SMI interrupt, the SMI interrupt is discarded and is optionally reported in the IOMMU event log (see MMIO Offset 0018h[SmiFLogEn]). This field is locked read-only by SmiFLock.

Table 77: SMI Filter Register MMIO Offset Assignments

SMI Filter Register Name	MMIO Offset	SMI Filter Register Name	MMIO Offset
SMI Filter Register 0	0060h	SMI Filter Register 8	00A0h
SMI Filter Register 1	0068h	SMI Filter Register 9	00A8h
SMI Filter Register 2	0070h	SMI Filter Register 10	00B0h
SMI Filter Register 3	0078h	SMI Filter Register 11	00B8h
SMI Filter Register 4	0080h	SMI Filter Register 12	00C0h
SMI Filter Register 5	0088h	SMI Filter Register 13	00C8h
SMI Filter Register 6	0090h	SMI Filter Register 14	00D0h
SMI Filter Register 7	0098h	SMI Filter Register 15	00D8h

3.4.4 Guest Virtual APIC Log Registers

MMIO Offset 00E0h Guest Virtual APIC Log Base Address Register

This register specifies the system physical address and length of the guest virtual APIC log. Guest virtual interrupt requests processed while `IRTE[IsRun] = 0b` are reported as 64-bit entries in the guest virtual APIC log (see [Section 2.7 \[Guest Virtual APIC \(GA\) Logging\]](#)). This register is reserved

when [Capability Offset 00h\[EFRSup\]](#) = 0b or when [MMIO Offset 0030h\[GASup\]](#) = 0b.

An `IO_PAGE_FAULT` event caused by a guest interrupt is reported in the IOMMU event log (see [Section 2.5.3 \[IO_PAGE_FAULT Event\]](#)). If `GALogLen` or `GALogBase` is changed while the [MMIO Offset 2020h\[GALogRun\]](#) = 1, the IOMMU response is undefined. The head and tail pointers for the guest virtual APIC log are found in the [Guest Virtual APIC Log Head Pointer Register \[MMIO Offset 2040h\]](#) and [Guest Virtual APIC Log Tail Pointer Register \[MMIO Offset 2048h\]](#).

63	60 59	56 55	52 51	32
Reserved	GALogLen	Reserved	GALogBase	
31			12 11	0
GALogBase			Reserved	

Bits	Description
63:60	Reserved.
59:56	<p>GALogLen: Guest virtual APIC log length. RW. Reset 1000b. Specifies the length of the guest virtual APIC log in power of 2 increments. The minimum size is 512 entries (4 Kbytes); values less than 1000b are reserved.</p> <p>0000b - 0111b = Reserved</p> <p>1000b = 512 entries (4 Kbytes)</p> <p>1001b = 1024 entries (8 Kbytes)</p> <p>1010b = 2048 entries (16 Kbytes)</p> <p>1011b = 4096 entries (32 Kbytes)</p> <p>1100b = 8192 entries (64 Kbytes)</p> <p>...</p> <p>1101b-1111b = reserved</p>
55:52	Reserved
51:12	<p>GALogBase: Guest virtual interrupt log base address. RW. Reset 00_0000_0000h. Specifies bits [51:12] of the base address of the guest virtual APIC log. The base address must be aligned to 4 Kbytes.</p>
11:0	Reserved

MMIO Offset 00E8h Guest Virtual APIC Log Tail Address Register

This register specifies the system physical address of the memory location containing the shadow tail pointer for the guest virtual APIC log (see [Guest Virtual APIC Log Tail Pointer Register \[MMIO Offset 2048h\]](#)). A new 64-bit entry is written to the guest virtual APIC log when a guest virtual interrupt addressed to a non-running guest OS is received by the IOMMU (see [Section 2.7 \[Guest Virtual APIC \(GA\) Logging\]](#)).

This register is reserved when [Capability Offset 00h\[EFRSup\]](#) = 0b or when [MMIO Offset 0030h\[GASup\]](#) = 0b. If `GALogLen` or `GALogBase` is changed while [MMIO Offset 2020h\[GALogRun\]](#) = 1, the IOMMU response is undefined. The register contains a system physical address as shown:

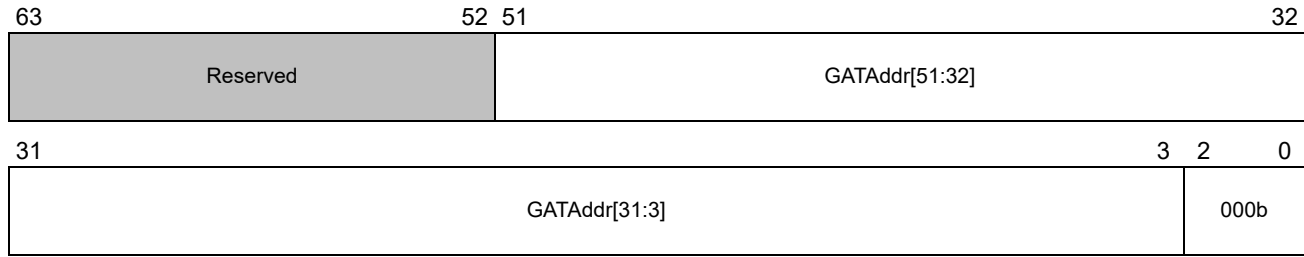

Bits	Description
63:52	Reserved.
51:3	GATAddr: Guest virtual APIC log tail address. RW. Reset 0. Specifies the SPA of the memory location containing the tail pointer of the guest virtual APIC log. The address must be aligned to a 8-byte boundary. When GATAddr is 0, the memory location is not updated and software must read the tail pointer from the Guest Virtual APIC Log Tail Pointer Register [MMIO Offset 2048h].
2:0	Reserved.

The 64-bit value pointed to by the [Guest Virtual APIC Log Tail Address Register \[MMIO Offset 00E8h\]](#) contains a shadow-copy of the relative tail pointer of the guest virtual APIC log. The tail of the guest virtual APIC log is at the SPA calculated as ([Guest Virtual APIC Log Base Address Register \[MMIO Offset 00E0h\]](#) + [MMIO Offset 00E8h\[GALogTail\]](#)). The memory location pointed to by [Guest Virtual APIC Log Tail Address Register \[MMIO Offset 00E8h\]](#) has the same format as the [Guest Virtual APIC Log Tail Pointer Register \[MMIO Offset 2048h\]](#).

3.4.5 Alternate PPR and Event Log Base Registers

MMIO Offset 00F0h PPR Log B Base Address Register

This register specifies the system physical address and length of the PPR log B. This register is reserved if the PPR Dual Buffer feature is not supported.

The head and tail pointers for the PPR log B are PPR Log B Head Pointer Register [MMIO Offset 2050h] and PPR Log B Tail Pointer Register [MMIO Offset 2058h].

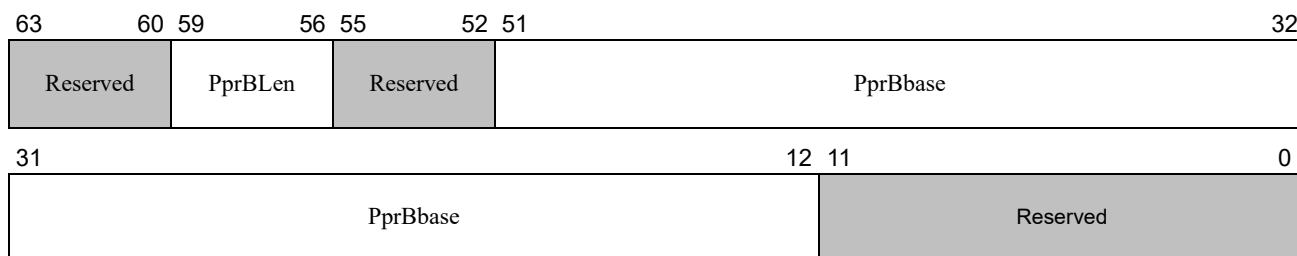

Bits	Description
63:60	Reserved.
59:56	PprBLen: Peripheral Page Request B Log length. RW. Reset 1000b. Specifies the length of the PPR Log B in power-of-2 increments. The minimum size is 512 entries (4 Kbytes); values less than 1000b are reserved. 0000b - 0111b = Reserved 1000b = 512 entries (4 Kbytes) 1001b = 1024 entries (8 Kbytes) 1010b = 2048 entries (16 Kbytes) 1011b = 4096 entries (32 Kbytes) 1100b = 8192 entries (64 Kbytes) ... 1101b–1111b = reserved
55:52	Reserved
51:12	PprBbase: Peripheral Page Request B Log base. RW. Reset 00_0000_0000h. Specifies bits [51:12] of the base address of the alternate (B) PPR Log. The base address programmed must be aligned to 4 Kbytes.
11:0	Reserved

MMIO Offset 00F8h Event Log B Base Address Register

This register specifies the system physical address and length of the event log.

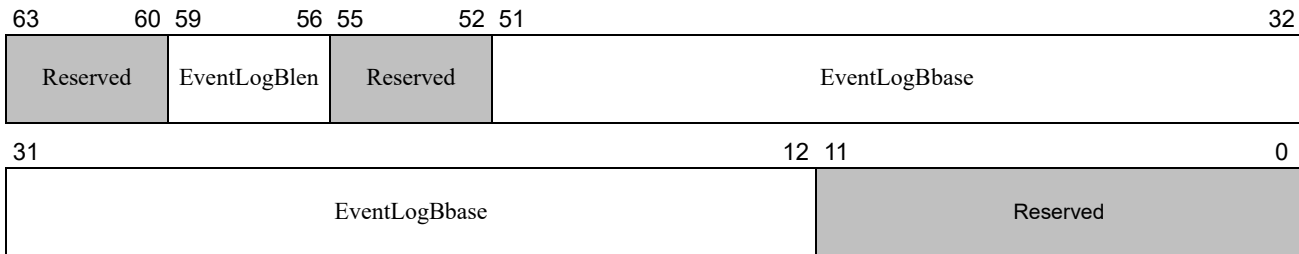

Bits	Description
63:60	Reserved.
59:56	EventLogBlen: Event log B length. RW. Reset 1000b. Specifies the length of the event log in power of 2 increments. The minimum size is 256 entries (4 Kbytes); values less than 1000b are reserved. 0000b - 0111b = Reserved 1000b = 256 entries (4 Kbytes) 1001b = 512 entries (8 Kbytes) ... 1111b = 32768 entries (512 Kbytes)
55:52	Reserved
51:12	EventLogBbase: Event log B base address. RW. Reset 00_0000_0000h. Specifies bits [51:12] of the base address of the event log. The base address must be aligned to 4 Kbytes.
11:0	Reserved

Software Note: If EventLogBlen or EventLogBbase are changed while the EventLogRun = 1, the IOMMU behavior is undefined.

3.4.6 Device Table Segment [1–7] Base Address Registers

MMIO Offset 01[00–30]h Device Table Segment n Base Address Register

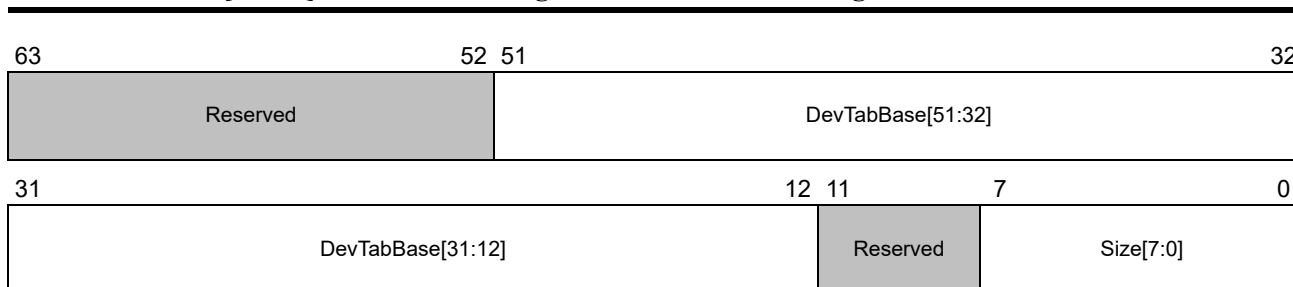

Bits	Description
63:52	Reserved.
51:12	DevTabBase: Device Table segment n base address. RW. Reset 00_0000_0000h. Specifies bits [51:12] of the 4 Kbyte aligned base address of this Device Table segment.
11:9	Reserved.
7:0	Size: Size of the Device Table segment n . RW. Reset 00h. This field contains an unsigned value m that specifies the size of the Device Table for this segment in 4 Kbyte increments. The size in bytes is equal to $(m + 1) * 4$ Kbytes.

These registers allow software to independently set the SPA of each enabled Device Table segment. When Device Table segmentation is supported and enabled, [Device Table Base Address Register \[MMIO Offset 0000h\]](#) serves as the base address register for segment 0. When Device Table segmentation is either not supported or not enabled, the [Device Table Base Address Register \[MMIO Offset 0000h\]](#) is used to specify the location and size of the single (unified) Device Table. [Table 78](#) below gives the MMIO offset of each of the seven Device Table Segment n Base Address Registers 1–7 and the maximum value of the **Size** field for each.

[MMIO Offset 0030h\[DevTblSegSup\]](#), when non-zero, gives the number of segments supported. If [MMIO Offset 0030h\[DevTblSegSup\]](#) = 00b, device table segmentation is not supported and the Device Table Segment n Base Address registers are reserved.

Table 78: Device Table Segment Base Address Registers; Offsets and Maximum Size Value

Register Name	MMIO Offset	Maximum Value of Size Field	Maximum Size(Bytes)
Device Table Segment 1 Base Address Register	0100h	FFh (255d)	1 Mbytes
Device Table Segment 2 Base Address Register	0108h	7Fh (127d)	512 Kbytes
Device Table Segment 3 Base Address Register	0110h	7Fh (127d)	512 Kbytes
Device Table Segment 4 Base Address Register	0118h	3Fh (63d)	256 Kbytes
Device Table Segment 5 Base Address Register	0120h	3Fh (63d)	256 Kbytes

Table 78: Device Table Segment Base Address Registers; Offsets and Maximum Size Value (Continued)

Register Name	MMIO Offset	Maximum Value of Size Field	Maximum Size(Bytes)
Device Table Segment 6 Base Address Register	0128h	3Fh (63d)	256 Kbytes
Device Table Segment 7 Base Address Register	0130h	3Fh (63d)	256 Kbytes

3.4.7 Device-Specific Feature Registers

The Device-Specific Feature Registers are used to report IOMMU hardware revision level information to system software. Three registers are defined: the Device-Specific Feature Extension Register, the Device-Specific Control Extension Register, and the Device-Specific Status Extension Register.

MMIO Offset 0138h Device-Specific Feature Extension (DSFX) Register

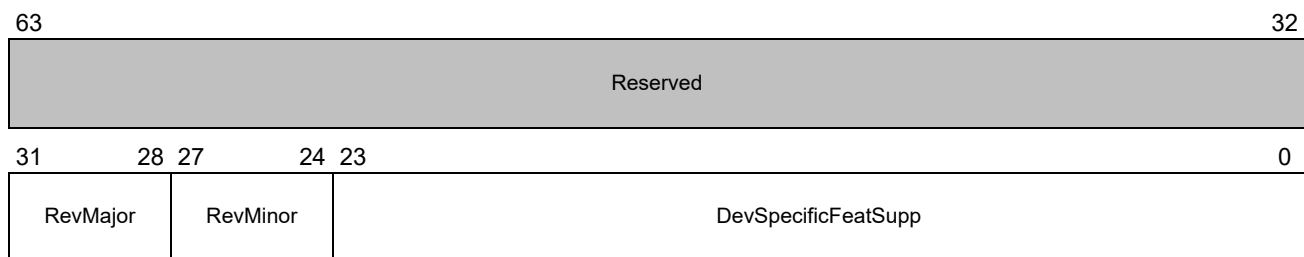

Bits	Description
63:28	Reserved.
31:28	RevMajor : RO. Major revision identifier.
27:24	RevMinor : RO. Minor revision identifier.
23:0	DevSpecificFeatSup : Bit fields provide specific feature support information. Definition is Implementation-specific.

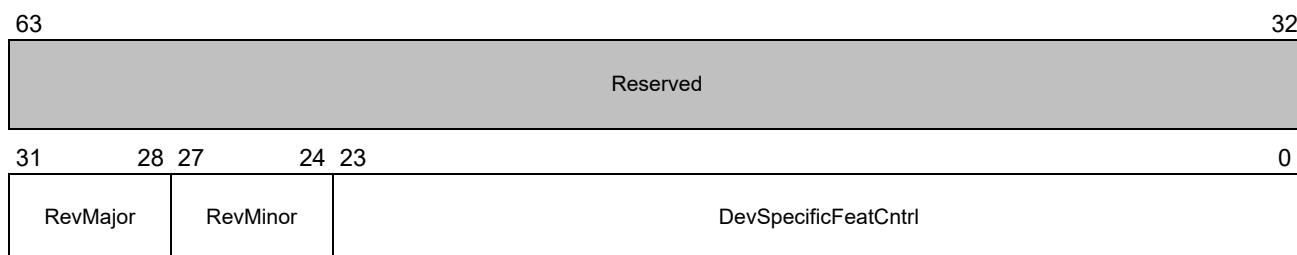
MMIO Offset 0140h Device-Specific Control Extension (DSCX) Register

Bits	Description
63:28	Reserved.
31:28	RevMajor : RO. Major revision identifier.
27:24	RevMinor : RO. Minor revision identifier.
23:0	DevSpecificFeatCtrl : RW. Reset 00_0000h. Fields (to be defined) used to control features reported in the DSFX register.

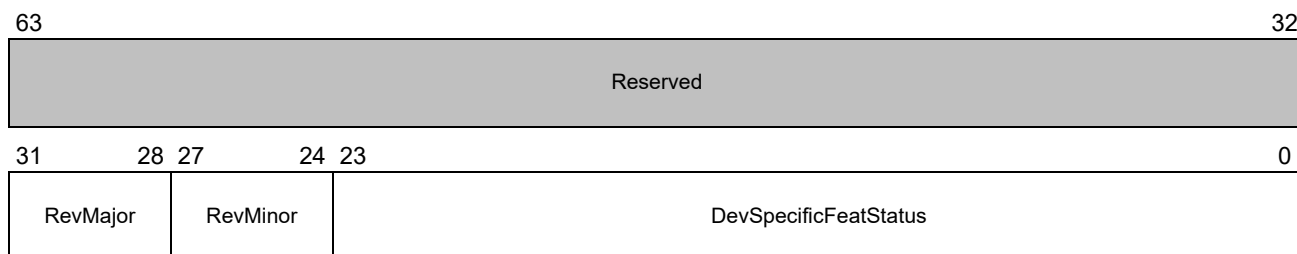
MMIO Offset 0148h Device-Specific Status Extension (DSSX) Register

Bits	Description
63:28	Reserved.
31:28	RevMajor : RO. Major revision identifier.
27:24	RevMinor : RO. Minor revision identifier.
23:0	DevSpecificFeatStatus : RW. Reset 00_0000h. Fields (to be defined) used to report the current status of features reported in the DSFX register.

3.4.8 MMIO Access to MSI Capability Block Registers

IOMMU optionally supports direct access via memory-mapped I/O reads and writes to specific register fields associated with MSI interrupts that would otherwise only be accessible via PCI configuration cycles. Only those fields of each register related to configuring and enabling MSI interrupts are accessible via this method.

MMIO Offset 0150h MSI Vector Register 0

This register shadows the fields of the [IOMMU Miscellaneous Information Register 0 \[Capability Offset 10h\]](#) used to set up the MSI vector number for the Event Log and PPR Log exception interrupts.



Bits	Description
31:27	MsiNumPpr: RO. Returns the value programmed into bits[31:27] of the capability register.
26:5	Reserved.
4:0	MsiNum: RO. Returns the value programmed into bits[4:0] of the capability register.

MMIO Offset 0154h MSI Vector Register 1

This register shadows the field of the [IOMMU Miscellaneous Information Register 1 \[Capability Offset 14h\]](#) used to set up the MSI / MSI-X vector number for the GA Log exception interrupt.

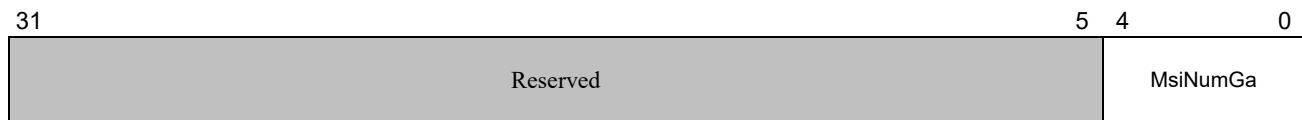

Bits	Description
31:5	Reserved.
4:0	MsiNumGa: RW. Reset 0_0000b.

MMIO Offset 0158h MSI Capability Header Register

This register shadows the header of the IOMMU MSI capability block.

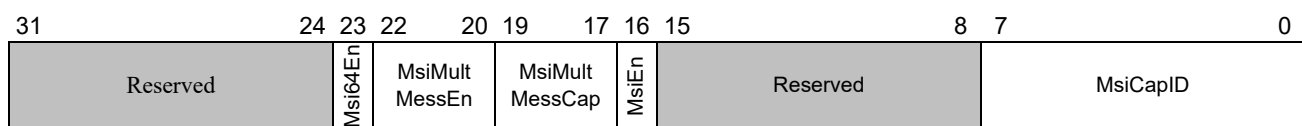

Bits	Description
31:24	Reserved.
23	Msi64bitEn : MSI 64-bit Enabled. RO. Reset 1b. This field always reads as 1 and indicates that the device (the IOMMU) supports 64-bit MSI addresses.
22:20	MsiMultMessEn : MSI Multi-message Enable. RW. Reset 000b. Used to program the number of MSI messages assigned to this function. MsiMultMessEn must be set to a value less than or equal to the value of MsiMultMessCap
19:17	MsiMultMessCap : MSI Multi-message Capability. RO. Reset xxxb. Specifies the number of MSI messages supported. 0 = MSI Multi-message capability not supported.
16	MsiEn : Message Signaled Interrupt Enable. RW. Reset 0. When set to 1, Message Signaled Interrupt capability is enabled.
15:8	Reserved.
7:0	MsiCapId : Capability ID. RO. Value = 05h.

MMIO Offset 015Ch MSI Address Low Register

This register provides read / write access to the low 32 bits of the IOMMU MSI address.

31	2 1 0
MsiAddr[31:2]	Reser ved

Bits	Description
31:2	MsiAddr[31:2] : RW. Reset xxxx_xxxxh. Bits [31:2] of the MSI address for the IOMMU. MsiAddr must be doubleword aligned, therefore bits [1:0] are always 0.
1:0	Reserved.

MMIO Offset 0160h MSI Address High Register

This register provides read / write access to the upper 32 bits of the IOMMU MSI address.

31	0
MsiAddr[63:32]	

Bits	Description
31:0	MsiAddr[63:32] : RW. Reset xxxx_xxxxh. Bits [63:32] of the MSI address for the IOMMU.

MMIO Offset 0164h MSI Data Register

This register provides read / write access to the IOMMU MSI data field.

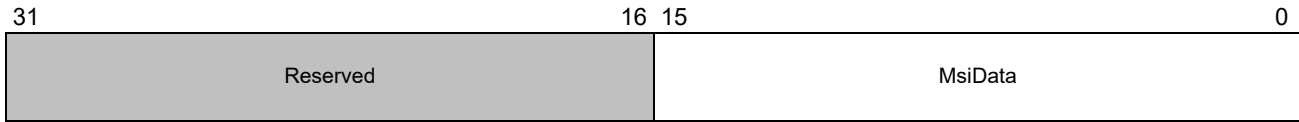

Bits	Description
31:16	Reserved.
15:0	MsiData: Message Signaled Interrupt Data. RW. Reset xxxh.

MMIO Offset 0168h MSI Mapping Capability Header Register

This register shadows the header of the IOMMU MSI Mapping capability block.

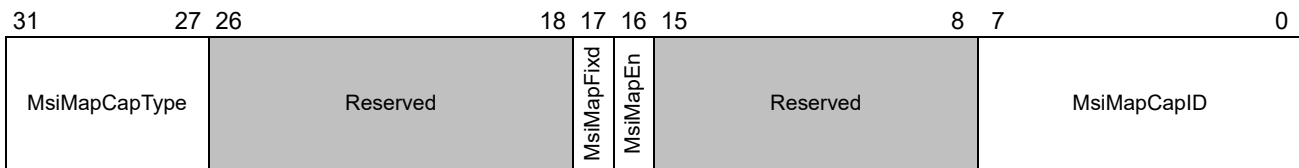

Bits	Description
31:27	MsiMapCapType: RO. Value = 15h. Indicates the MSI Mapping Capability.
26:18	Reserved.
17	MsiMapFixd: MSI Map Fixed. RO. Value = 1b. MSI mapping range is fixed.
16	MsiMapEn: MSI Map Enable. RO. Value = 1b. Message Signaled Interrupt mapping capability is enabled.
15:8	Reserved.
7:0	MsiMapCapId: Capability ID. RO. Value = 08h.

3.4.9 Performance Optimization Control Register

MMIO Offset 016Ch IOMMU Performance Optimization Control Register

This register is used by system software to enable the optional IOMMU Performance Optimization feature. This feature allows accesses from privileged (usually integrated) I/O devices such as GPUs to bypass the IOMMU when directly accessing system memory. It is recommended to set this bit, unless it is planned for the system software to use the the host I/O tables for GPA->SPA redirection

The register contains the PerfOptEn bit, which when set to 1 enables the feature. System software may enable this feature if it is using the translation mechanism within the device rather than the IOMMU to protect/translate integrated GPU access to system memory. These accesses may instead be protected by controlling the private TLB inside the GPU. The mechanisms to do so are outside the scope of the IOMMU specification.

A HV may enable this feature if it directly assigns an integrated GPU to a Guest OS and it maps the Guest memory such that GPA = SPA. The MARC feature provides more flexibility to the HV and is the preferred mechanism to use under virtualization. Both PerfOpt and MARC allow realtime DMA clients (e.g., display, audio, ...) to access system memory with lower latency.

This register is supported if [MMIO Offset 0030h](#)[PerfOptSup] = 1; otherwise this register is reserved.



Bits	Description
31:14	Reserved.
13	PerfOptEn. RW. Reset 0b.
12:0	Reserved.

3.4.10 IOMMU x2APIC Control Register

IOMMU generated interrupts will have field values based on the programming in XT IOMMU Interrupt Control Registers in MMIO 0x170-0x180 when MMIO 0x18[IntCapXTEn]=1.

MMIO Offset 0x170h XT IOMMU General Interrupt Control Register

This register is used to define the fields used for the interrupt message generated by the IOMMU for Event Log exception interrupts and Completion_wait interrupts when MMIO 0x18[IntCapXTEn]=1.

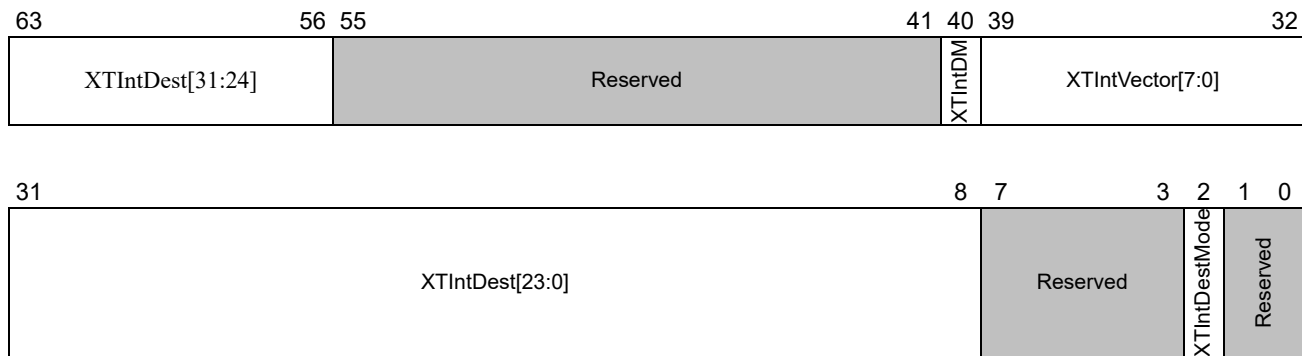

Bits	Description
63:56	XTIntDest[31:24]: RW. Destination field bit[31:24] for IOMMU general interrupt when x2APIC is enabled.
55:41	Reserved
40	XTIntDM: RW. Delivery Mode for IOMMU general interrupt when x2APIC is enabled. 0 = Fixed, 1 = Arbitrated
39:32	XTIntVector[7:0]: RW. Vector field for IOMMU general interrupt when x2APIC is enabled.
31:8	XTIntDest[23:0]: RW. Destination field bit[23:0] for IOMMU general interrupt when x2APIC is enabled.
7:3	Reserved
2	XTIntDestMode: RW. Destination Mode for IOMMU PPR interrupt when x2APIC is enabled. 0 = Physical Mode, 1 = Logical Mode
1:0	Reserved

MMIO Offset 0x178h XT IOMMU PPR Interrupt Control Register

This register is used to define the fields used for the interrupt message generated by the IOMMU for PPR Log exception interrupts when MMIO 0x18[IntCapXTEn]=1.

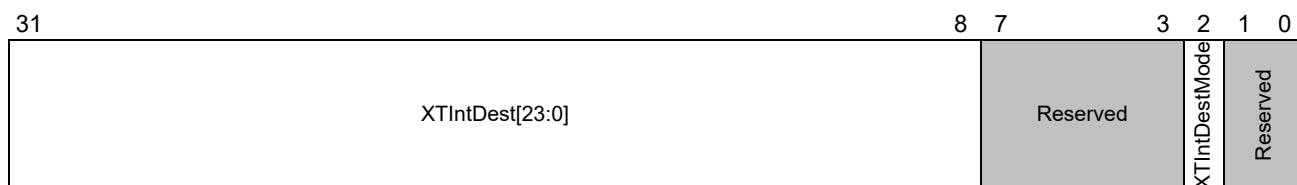
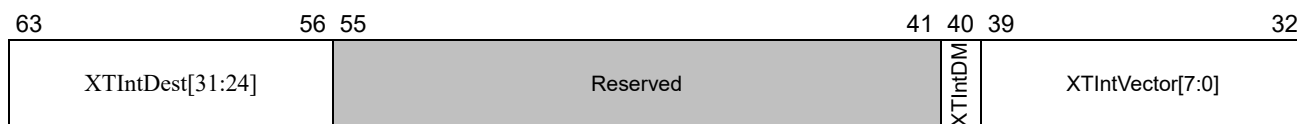

Bits	Description
63:56	XTIntDest[31:24]: RW. Destination field bit[31:24] for IOMMU PPR interrupt when x2APIC is enabled.
55:41	Reserved
40	XTIntDM: RW. Delivery Mode for IOMMU PPR interrupt when x2APIC is enabled. 0 = Fixed, 1 = Arbr0
39:32	XTIntVector[7:0]: RW. Vector field for IOMMU PPR interrupt when x2APIC is enabled.
31:8	XTIntDest[23:0]: RW. Destination field bit[23:0] for IOMMU PPR interrupt when x2APIC is enabled.
7:3	Reserved
2	XTIntDestMode: RW. Destination Mode for IOMMU PPR interrupt when x2APIC is enabled. 0 = Physical Mode, 1 = Logical Mode.
1:0	Reserved

MMIO Offset 0x180h XT IOMMU GA Log Interrupt Control Register

This register is used to define the fields used for the interrupt message generated by the IOMMU for GA Log exception interrupts when MMIO 0x18[IntCapXTEn]=1.

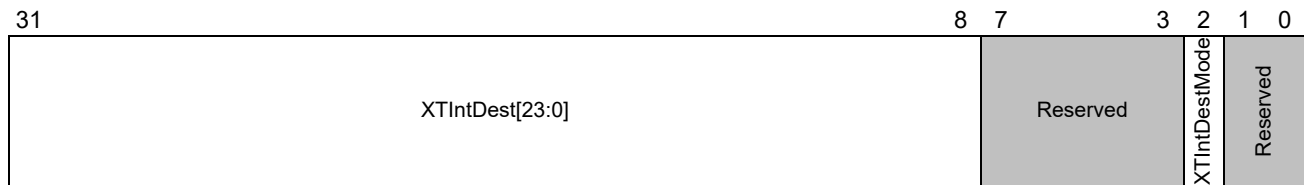
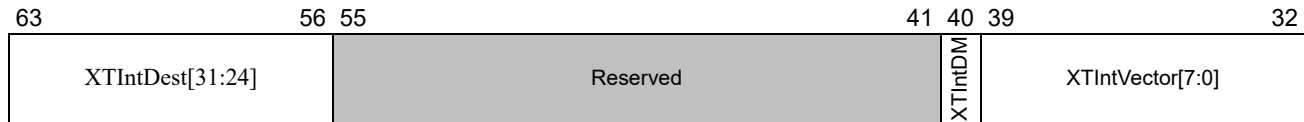

Bits	Description
63:56	XTIntDest[31:24]: RW. Destination field bit[31:24] for IOMMU GA Log interrupt when x2APIC is enabled.
55:41	Reserved
40	XTIntDM: RW. Delivery Mode for IOMMU GA Log interrupt when x2APIC is enabled.
39:32	XTIntVector[7:0]: RW. Vector field for IOMMU GA Log interrupt when x2APIC is enabled.
31:8	XTIntDest[23:0]: RW. Destination field bit[23:0] for IOMMU GA Log interrupt when x2APIC is enabled.
7:3	Reserved
2	XTIntDestMode: RW. Destination Mode for IOMMU GA Log interrupt when x2APIC is enabled. 0 = physical CPU, 1 = logical CPU.
1:0	Reserved

3.4.11 vIOMMU Status Register

MMIO Offset 0x190h vIOMMU Status Register

This register indicates the current status of the vIOMMU

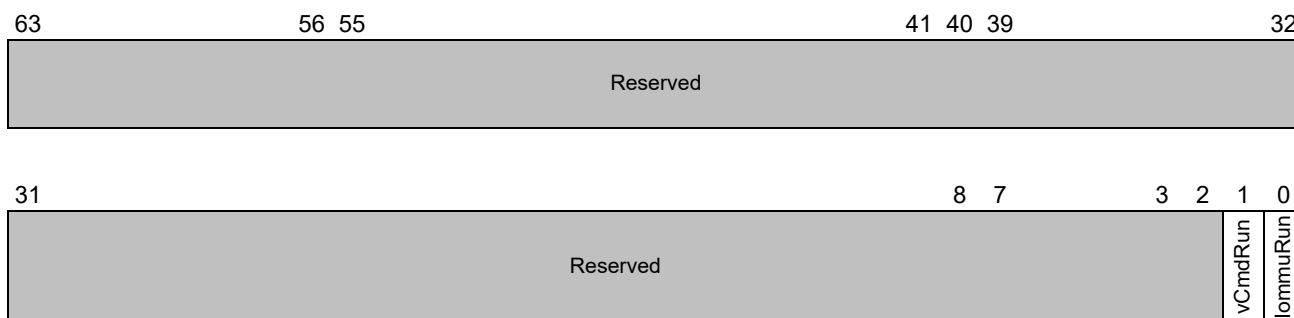

Bits	Description
63:2	Reserved
1	vCmdRun: RO. 1 = virtualized command buffers process are running. 0 = vIOMMU stop processing virtualized command buffers.
0	vIommuRun: RO. 1 = virtualized IOMMU functionality is running. 0 = virtualized IOMMU functionality is not running.

3.4.12 Memory Access and Routing (MARC) Registers

The Memory Access Routing and Control (MARC) feature provides a fast static translation mechanism that provides I/O device domain to system physical address translation with simple read-only or read / write access permissions. When a DVA emitted by an I/O device falls within one of the programmed and enabled MARC apertures, and access permissions match, the translation is applied and the remainder of the translation process is bypassed.

Support for the MARC feature is indicated by [MMIO Offset 0030h](#)[MarcSup] = 1.

If the I/O device domain address does not fall within any of the enabled MARC apertures, or if the access permissions do not match, the address is passed on to the remainder of the translation process.

This feature allows trusted system software to allocate several contiguous physical ranges for low-latency graphics processing in virtualized systems.

Each aperture and its corresponding translation address with access permissions is set up by software by programming a set of three MARC aperture registers. These are the MARC Aperture Base Register, Length Register, and Relocation Register. When supported, MARC provides either four or eight of these register tuples.

Implementation Note: *The first revision 2.6 implementation provides four sets (four triplets) of these registers.*

For each aperture, the base, relocation, and length registers are located in consecutive quadword-aligned MMIO offsets. The following table lists these offsets.

Table 79: MARC Aperture Register Offsets (hexadecimal)

Aperture	Base Register	Relocation Register	Length Register
0	200	208	210
1	218	220	228
2	230	238	240
3	248	250	258

The registers are defined below:

MMIO Offset 02[00,18,30,48]h MARC Aperture [0–3] Base Register

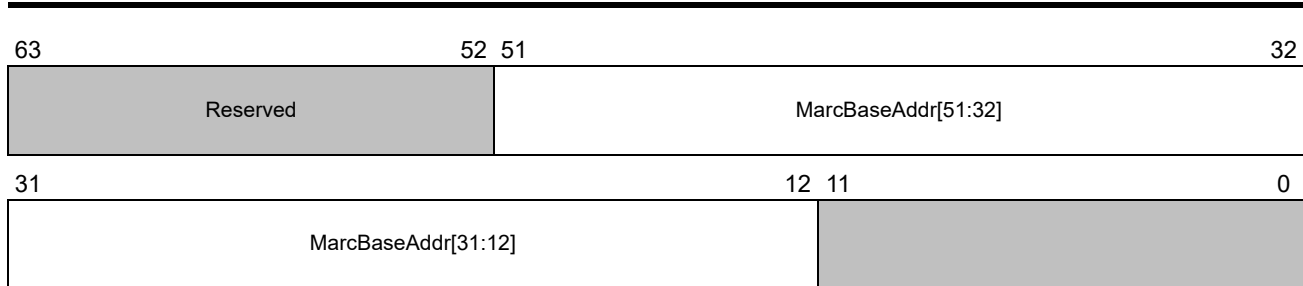

Bits	Description
63:52	Reserved.
51:12	MarcBaseAddr: MARC aperture base address. RW. Reset 00_0000_0000h. Specifies bits [51:12] of the 4 Kbyte aligned base address of a MARC memory aperture in the device’s address space.
11:0	Reserved.

Note: MMIO Offsets 02[60,78,90,A8]h are reserved.

MMIO Offset 02[08,20,38,50]h MARC Aperture [0–3] Relocation Register

63	52 51	32
Reserved	MarcRelocAddr[51:32]	
31	12 11	0
MarcRelocAddr[31:12]		Reserved
		ReadOnly RelocEn

Bits	Description
63:52	Reserved.
51:12	MarcRelocAddr : MARC aperture relocation address. RW. Reset 00_0000_0000h. Specifies bits [51:12] of the 4 Kbyte aligned system physical address (SPA) for the aperture defined by the corresponding MARC base and length registers.
11:2	Reserved.
1	ReadOnly : RW. Reset 0. 0 = Read and write accesses are allowed. 1 = Only read accesses are allowed. <i>Note: when access permission fails, no error is flagged and the address is passed on to the IOMMU translation mechanism.</i>
0	RelocEn : Relocation Enable. RW. Reset 0. 0 = ignore this aperture base address, length, and relocation address. 1 = base address, length, and relocation address for this aperture are valid and active.

Note: MMIO Offsets 02[68,80,98,B0]h are reserved.

MMIO Offset 02[10,28,40,58]h MARC Aperture [0–3] Length Register

63	52 51	32
Reserved	MarcLength[51:32]	
31	12 11	0
MarcLength[31:12]		Reserved

Bits	Description
63:52	Reserved.
51:12	MarcLength : MARC aperture Length. RW. Reset 00_0000_0000h. Bits [51:12] of this register, interpreted as an unsigned integer, indicates the length of the MARC aperture in 4-Kbyte pages.
11:0	Reserved.

Note: MMIO Offsets 02[70,88,A0,B8]h are reserved.

To define an aperture of one 4-Kbyte page, the value of MarcLength is programmed to 1. If MarcLength is programmed to 0 (or left unchanged from its default value) and the aperture is enabled (by setting MMIO Offset 02[08,20,38,50]h[RelocEn] to 1), the resultant behavior is implementation-dependent, but does not result in the signaling of an error.

3.4.13 Extended Feature 2 Register

MMIO Offset 01A0h IOMMU Extended Feature 2 Register

This register specifies the extended features supported by the IOMMU.

Note: When Capability Offset 00h[EFRSup] = 0b, this register is reserved, and the features described by it are not supported by the IOMMU.

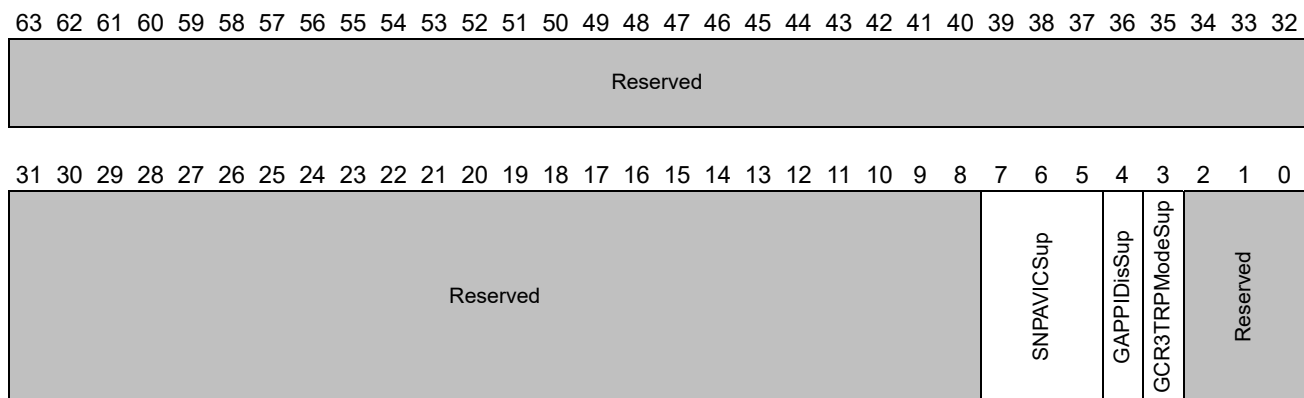

Bits	Description
63:8	Reserved.
7:5	SNPAVICSup: RO. 000b = No advanced interrupt features supported (interrupt remapping only) when the system is SNP-enabled. All other encodings reserved.
4	GAPPIDisSup: RO Support for masking Guest APIC Physical Processor Interrupt based on IRTE[GAPPIDis] when Interrupt Virtualization is enabled. See Section 2.2.5.4, “Guest APIC Physical Processor Interrupt” on page 96.
3	GCR3TRPModeSup: RO Support for GPA based GCR3 Pointer inside DTE. 0: Pointer to GCR3 Table inside DTE is SPA. 1: Pointer to GCR3 Table in DTE is GPA based. The GPA must be translated by IOMMU using nested page tables to be system physical addresses (see Section 2.2.3, “I/O Page Tables for Host Translations” on page 77).
2:0	Reserved.

3.4.14 Reserved Register

MMIO Offset 1FF8h IOMMU Reserved Register

Reserved. RW. Reset 0. Not for software use.

63	IommuReserved[63:32]	32
----	----------------------	----

31	IommuReserved[31:0]	0
----	---------------------	---

Bits	Description
63:0	IommuReserved: Reserved register. RW. Reset 0. Reserved for hardware use. Not for software use.

Software Note: Software should not access this register.

3.4.15 Command and Event Log Pointer Registers

MMIO Offset 2000h Command Buffer Head Pointer Register

This register points to the offset in the command buffer that will be read next by the IOMMU.

63	Reserved			32
31	19 18	4 3	0	
	Reserved	CmdHeadPtr	Reserved	

Bits	Description
63:19	Reserved.
18:4	CmdHeadPtr: Command buffer head pointer. RW. Reset 0000h. Specifies the 16-byte aligned offset from the command buffer base address register of the next command to be fetched by the IOMMU. The IOMMU increments this register, rolling over to zero at the end of the buffer, after fetching and validating the command in the command buffer. After incrementing this register, the IOMMU cannot re-fetch the command from the buffer. If this register is written to by software while CmdBufRun = 1b, the IOMMU behavior is undefined. If this register is set by software to a value outside the length specified by MMIO Offset 0008h[ComLen] , the IOMMU behavior is undefined.
3:0	Reserved.

MMIO Offset 2008h Command Buffer Tail Pointer Register

This register points to the offset in the command buffer that will be written next by the software.

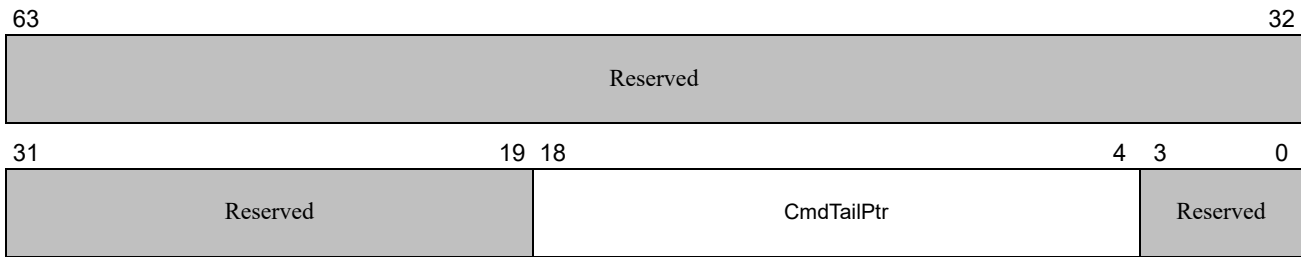

Bits	Description
63:19	Reserved.
18:4	CmdTailPtr: Command buffer tail pointer. RW. Reset 0000h. Specifies the 128-bit aligned offset from the command buffer base address register of the next command to be written by the software. Software must increment this field, rolling over to zero at the end of the buffer, after writing a command to the command buffer. If software advances the tail pointer equal to or beyond the head pointer after adding one or more commands to the buffer, the IOMMU behavior is undefined. If software sets the command buffer tail pointer to an offset beyond the length of the command buffer, the IOMMU behavior is undefined.
3:0	Reserved.

MMIO Offset 2010h Event Log Head Pointer Register

This register points to the offset in the event buffer that will be read next by the software.

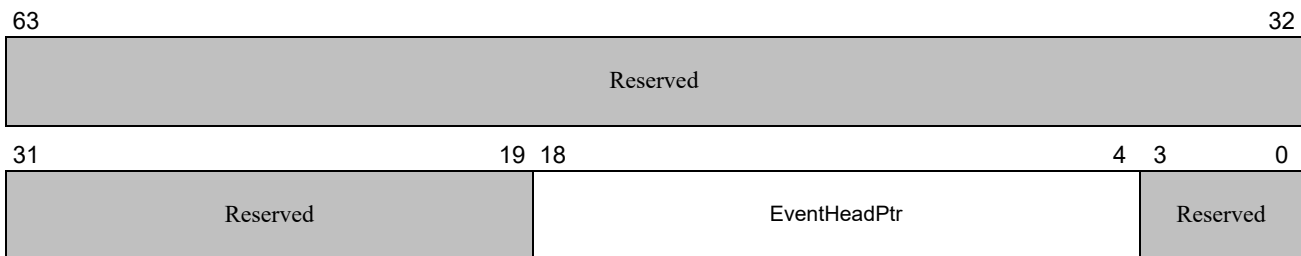

Bits	Description
63:19	Reserved.
18:4	EventHeadPtr: Event log head pointer. RW. Reset 0000h. Specifies the 128 bit aligned offset from the event log base address register that will be read next by software. Software must increment this field, rolling over at the end of the buffer, after reading an event from the event log. If software advances the head pointer beyond the tail pointer, the IOMMU behavior is undefined. If software sets the event log head pointer to an offset beyond the length of the event log, the IOMMU behavior is undefined.
3:0	Reserved.

Bits	Description
63:19	Reserved.
18	<p>PprOvrflwEarly: PPR log Overflow Early warning. RW1C Reset 0b. 1 = IOMMU PPR log has reached its early overflow threshold.</p> <p>When supported and enabled, hardware sets this bit when the number of free entries in the PPR Log has reached the programmed threshold. When MMIO Offset 0018h[PprAutoRspEn] = 1, hardware will generate auto responses for PPR requests but will pass Stop marker PPR messages through to the PPR log. The PPR Log overflow early warning feature is enabled by setting MMIO Offset 2088[PprOvrflwEarlyEn] (bit 31).</p>
17	<p>PprOvrflwEarlyB: PPR log B Overflow Early warning. RW1C Reset 0b. 1 = IOMMU PPR log B has reached its early overflow threshold.</p> <p>When supported and enabled, hardware sets this bit when the number of free entries in the PPR Log has reached the programmed threshold. When MMIO Offset 0018h[PprAutoRspEn] = 1, hardware will generate auto responses for PPR requests but will pass Stop marker PPR messages through to the PPR log B. The PPR Log overflow early warning feature is enabled by setting MMIO Offset 2090[PprBOvrflwEarlyEn] (bit 31).</p>
16	EventLogActive: RO Reset 0b. 0 = Event Log A is active. 1 = Event Log B is active.
15	EventOvrflwB: RW1C Reset 0b. 1 = Event Log B has overflowed. When the dual event log feature is supported and enabled, EventOverflow (bit 0) serves as the Event Log A overflow indication.
14:13	Reserved.
12	PprLogActive: RO Reset 0b. 0 = PPR Log A is active. 1 = PPR Log B is active.
11	PprOvrflwB: RW1C Reset 0b. 1 = PPR Log B has overflowed. When the dual PPR log feature is supported and enabled, PPROverflow (bit 5) serves as the PPR Log A overflow indication.
10	<p>GAInt: Guest virtual APIC log Interrupt. RW1C. Reset 0b. 1 = Virtual interrupt request written to the guest virtual APIC log by the IOMMU. 0 = No log entry written. An interrupt is generated when GAInt changes from 0b to 1b and MMIO Offset 0018h[GAIntEn] = 1b.</p> <p>Software Note: Upon servicing a GA log interrupt, the software should clear GAInt to 0b (RW1C).</p>
9	<p>GALOverflow: Guest virtual APIC log Overflow. RW1C. Reset 0b. 1 = IOMMU guest virtual APIC event log overflow has occurred. This bit is set when a new guest virtual APIC event is to be written to the log and there is no usable entry in the log, causing the new event information to be discarded. No interrupt is generated when GALOverflow is changed from 0b to 1b. No new guest virtual APIC log entries are written while this bit is set. The virtual APIC backing page is always updated so the interrupt is not lost. Software Note: <i>To resume logging, adjust the head and tail pointers, clear GALOverflow (W1C) and write to MMIO Offset 0018h[GALogEn].</i></p>
8	<p>GALogRun: Guest virtual APIC logging is running. RO. Reset 0b. 1 = guest virtual APIC events are logged as they occur when the guest is not running (see IRTE[IsRun] in Figure 18 on page 93). 0 = guest virtual APIC events are discarded without logging. When GALOverflow = 1, the IOMMU does not write new guest virtual APIC log entries even when GALogRun = 1. When halted, guest virtual APIC event logging is restarted by using MMIO Offset 0018h[GALogEn].</p>
7	<p>PPRLogRun: Peripheral page request logging is running. RO. Reset 0b. 1 = PPR requests are logged as they occur. 0 = PPR requests are discarded without logging. When PprOverflow = 1b, the IOMMU does not write new PPR log entries even when PPRLogRun = 1b. When halted, PPR request logging is restarted by using MMIO Offset 0018h[PPRLogEn].</p>
6	<p>PprInt: Peripheral page request interrupt. RW1C. Reset 0b. 1 = PPR request entry written to the PPR log by the IOMMU. 0 = No PPR entry written to the PPR log by the IOMMU. An interrupt is generated when PprInt changes from 0b to 1b and MMIO Offset 0018h[PprIntEn] = 1b.</p> <p>Software Note: Upon servicing a PPR interrupt, the software should clear PprInt to 0b (RW1C).</p>

Bits	Description
5	<p>PprOverflow: Peripheral page request log overflow. RW1C. Reset 0b. 1 = IOMMU PPR log overflow has occurred. This bit is set when a new peripheral page request is to be written to the PPR log and there is no usable entry in the PPR log, causing the new event information to be discarded. An interrupt is generated when PprOverflow = 1b and MMIO Offset 0018h[PprIntEn] = 1b (see Capability Offset 10h[MsiNumPPR]). No new PPR log entries are written while this bit is set.</p> <p>Software Note: To resume logging, clear PprOverflow (W1C), and write a 1 to MMIO Offset 0018h[PPRLogEn]. This condition can be eliminated by setting PprOvrflwB bit and increasing the PprLogA size while PprLogB is used, then switching back.</p>
4	<p>CmdBufRun: Command buffer is running. RO. Reset 0b. 1 = the IOMMU may fetch commands from the command buffer. 0 = IOMMU does not fetch commands from the command buffer. The IOMMU stops command processing after COMMAND_HARDWARE_ERROR (Section 2.5.7 [COMMAND_HARDWARE_ERROR Event]) and ILLEGAL_COMMAND_ERROR (Section 2.5.6 [ILLEGAL_COMMAND_ERROR Event]) events. When CmdBufRun = 0, the IOMMU will not fetch commands until software programs MMIO Offset 0018h[CmdBufEn].</p> <p>Implementation Note: CmdBufRun is level-sensitive; once set to 1, it does not change to 0 until command processing stops for cause; and once set to 0, it does not change to 1 until MMIO Offset 0018h[CmdBufEn] is written with 1 by software.</p>
3	<p>EventLogRun: Event logging is running. RO. Reset 0b. 1 = events are logged as they occur. 0 = event reports are discarded without logging. When EventOverflow = 1b, the IOMMU does not write new event log entries even when EventLogRun = 1b. When halted, event logging is restarted by using MMIO Offset 0018h[EventLogEn].</p>
2	<p>ComWaitInt: Completion wait interrupt. RW1C. Reset 0b. 1 = COMPLETION_WAIT command completed. This bit is only set if the i bit is set in the COMPLETION_WAIT command. An interrupt is generated when ComWaitInt = 1b and MMIO Offset 0018h[ComWaitIntEn] = 1b (see Capability Offset 10h[MsiNum]).</p> <p>Software Note: Upon servicing this interrupt, software should clear ComWaitInt to 0b (RW1C).</p>
1	<p>EventLogInt: Event log interrupt. RW1C. Reset 0b. 1 = Event entry written to the event log by the IOMMU. 0 = No event entry written to the event log by the IOMMU. An interrupt is generated when EventLogInt = 1b and MMIO Offset 0018h[EventIntEn] = 1b.</p> <p>Software Note: Upon servicing this interrupt, software should clear EventLogInt to 0b (RW1C).</p>
0	<p>EventOverflow: Event log overflow. RW1C. Reset 0b. 1 = IOMMU event log overflow has occurred. This bit is set when a new event is to be written to the event log and there is no usable entry in the event log, causing the new event information to be discarded. An interrupt is generated when EventOverflow = 1b and MMIO Offset 0018h[EventIntEn] = 1b. No new event log entries are written while this bit is set. Software Note: To resume logging, clear EventOverflow (W1C), and write a 1 to MMIO Offset 0018h[EventLogEn].</p>

3.4.17 PPR Log Head and Tail Pointer Registers

MMIO Offset 2030h IOMMU PPR Log Head Pointer Register

This register points to the offset in the peripheral page request log entry that will be read next by the software. If EFR[PPRSup] = 0, this register is reserved.

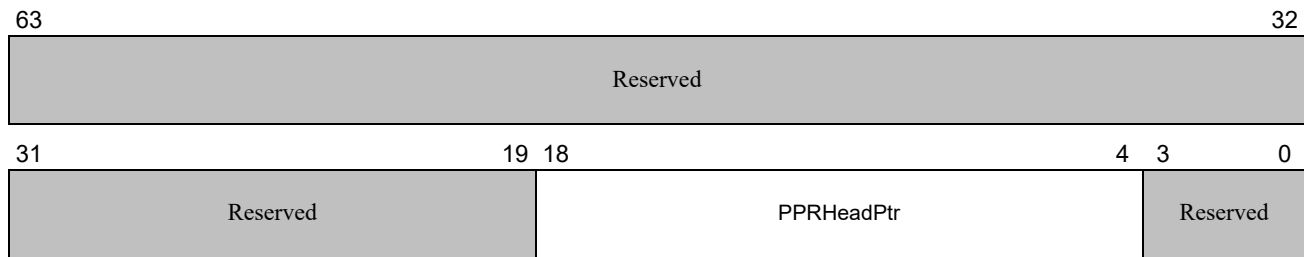

Bits	Description
63:19	Reserved.
18:4	PPRHeadPtr: Peripheral page request log head pointer. RW. Reset 0000h. Specifies the 128 bit aligned offset from the PPR log base address register that will be read next by software. Software must increment this field, rolling over at the end of the buffer, after reading a PPR request entry from the PPR event log. If software advances the head pointer beyond the tail pointer, the IOMMU behavior is undefined. If software sets the PPR log head pointer to an offset beyond the length of the PPR log, the IOMMU behavior is undefined.
3:0	Reserved.

MMIO Offset 2038h IOMMU PPR Log Tail Pointer Register

This register points to the offset in the peripheral page request log that will be written next by the IOMMU. If EFR[PPRSup] = 0, this register is reserved.

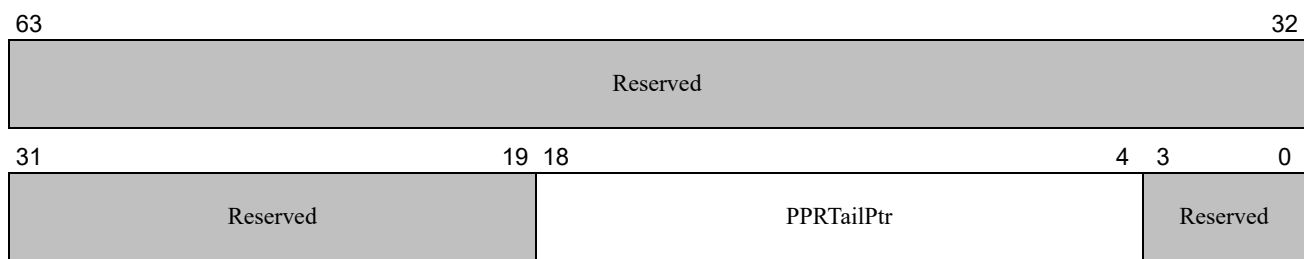

Bits	Description
63:19	Reserved.
18:4	PPRTailPtr : peripheral page request log tail pointer. RW. Reset 0000h. Specifies the 128 bit aligned offset from the PPR log base address register that will be written next by the IOMMU when a PPR request is detected. The IOMMU increments this register, rolling over at the end of the buffer, after writing a PPR request to the PPR log. If this register is written while PPRLogRun = 1, IOMMU behavior is undefined. If this register is set by software to a value outside the length specified by MMIO Offset 0038h [PPRLen], IOMMU behavior is undefined.
3:0	Reserved.

3.4.18 Guest Virtual APIC Log Head and Tail Pointer Registers

MMIO Offset 2040h Guest Virtual APIC Log Head Pointer Register

This register points to the byte offset in the guest virtual APIC log that will be read next by system software. If EFR[GASup] = 0, this register is reserved.

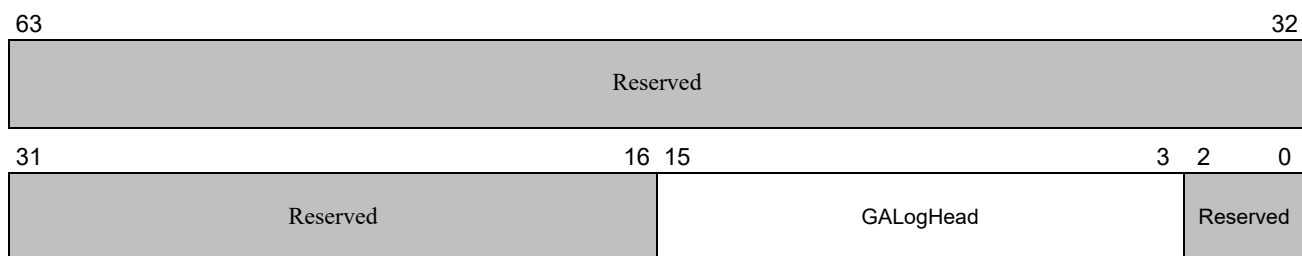

Bits	Description
63:16	Reserved.
15:0	GALogHead : Guest virtual APIC log head pointer. RW. Reset 0000h. Specifies the 64-bit aligned offset from the Guest Virtual APIC Log Base Address Register [MMIO Offset 00E0h] that will be read next by software. Software must increment this field, rolling over at the end of the buffer, after reading an entry from the GA log. If software advances the head pointer to or beyond the tail pointer, the IOMMU behavior is undefined.

MMIO Offset 2048h Guest Virtual APIC Log Tail Pointer Register

This register points to the byte offset in the guest virtual APIC log that will be written next by the IOMMU. If EFR[GASup] = 0, this register is reserved.

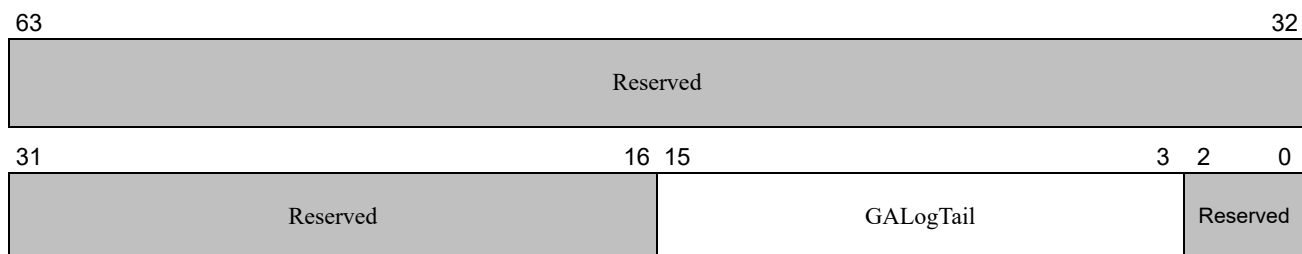

Bits	Description
63:16	Reserved.
15:0	<p>GALogTail: Guest virtual APIC log tail pointer. RW. Reset 0000h. Specifies the 8-byte aligned offset from the Guest Virtual APIC Log Base Address Register [MMIO Offset 00E0h] that will be written next by the IOMMU when an undelivered virtual interrupt request needs to be entered into the log. The IOMMU increments this register, rolling over at the end of the buffer, after writing an entry into the log.</p> <p>Note: IOMMU maintains a copy of the GA Log tail pointer in system memory at the address pointed to by the contents of the Guest Virtual APIC Log Tail Address Register [MMIO Offset 00E8h].</p>

3.4.19 PPR Log B Head and Tail Pointer Registers

MMIO Offset 2050h PPR Log B Head Pointer Register

This register points to the offset the entry in the peripheral page request log B that will be read next by the software. If EFR[[DualPPRLogSup](#)] = 0, this register is reserved.

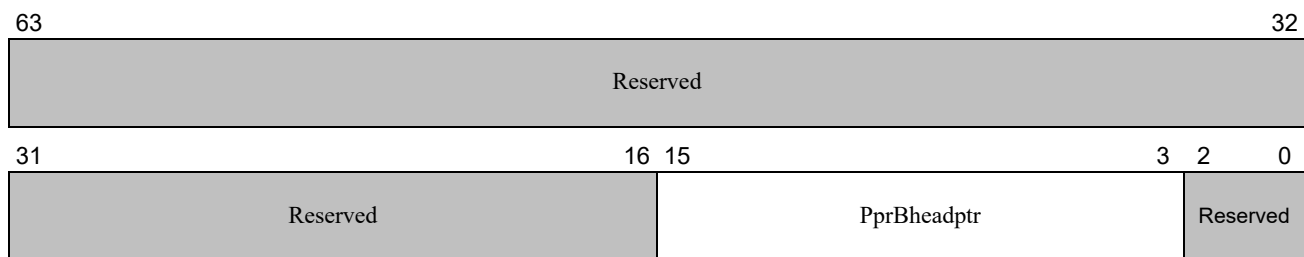

Bits	Description
63:16	Reserved.
18:4	<p>PprBheadptr: Peripheral page request log B head pointer. RW. Reset 0000h. Specifies the 128 bit aligned offset from the PPR log B base address register that will be read next by software. Software must increment this field, rolling over at the end of the buffer, after reading a PPR request entry from the PPR log. If software advances the head pointer beyond the tail pointer, the IOMMU behavior is undefined. If software sets the PPR log B head pointer to an offset beyond the length of the PPR log, the IOMMU behavior is undefined.</p>

MMIO Offset 2058h PPR Log B Tail Pointer Register

This register points to the offset in the peripheral page request log B that will be written next by the IOMMU. If EFR[[DualPPRLogSup](#)] = 0, this register is reserved.

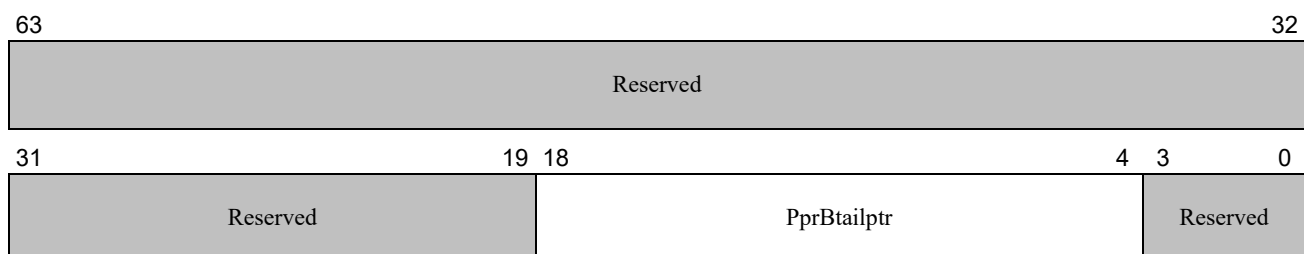

Bits	Description
63:19	Reserved.
18:4	PprBtailptr : peripheral page request log B tail pointer. RW. Reset 0000h. Specifies the 128 bit aligned offset from the PPR log B base address register that will be written next by the IOMMU when a PPR request is detected. The IOMMU increments this register, rolling over at the end of the buffer, after writing a PPR request to the PPR log B. If this register is written while PPRLogRun = 1, IOMMU behavior is undefined. If this register is set by software to a value outside the length specified by MMIO Offset 00F0h [PprBLen], IOMMU behavior is undefined.
3:0	Reserved.

3.4.20 Event Log B Head and Tail Pointer Registers

MMIO Offset 2070h Event Log B Head Pointer Register

This register points to the offset in the event log B that will be read next by the software. If EFR[DualEventLogSup] = 0, this register is reserved.

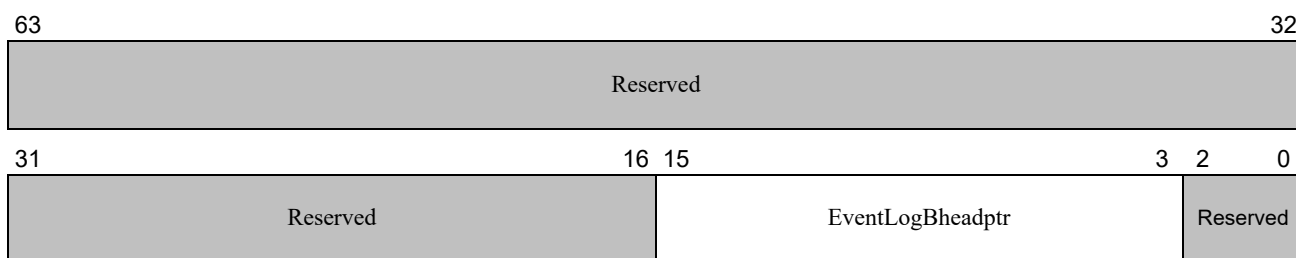

Bits	Description
63:16	Reserved.
18:4	EventLogBheadptr : Event log B head pointer. RW. Reset 0000h. Specifies the 128 bit aligned offset from the Event Log B base address register that will be read next by software. Software must increment this field, rolling over at the end of the buffer, after reading an event log entry from the Event log B. If software advances the head pointer beyond the tail pointer, the IOMMU behavior is undefined. If software sets the Event log B head pointer to an offset beyond the length of the Event log B, the IOMMU behavior is undefined.

MMIO Offset 2078h Event Log B Tail Pointer Register

This register points to the offset in the event Log B buffer that will be written next by the IOMMU. If EFR[DualEventLogSup] = 0, this register is reserved.

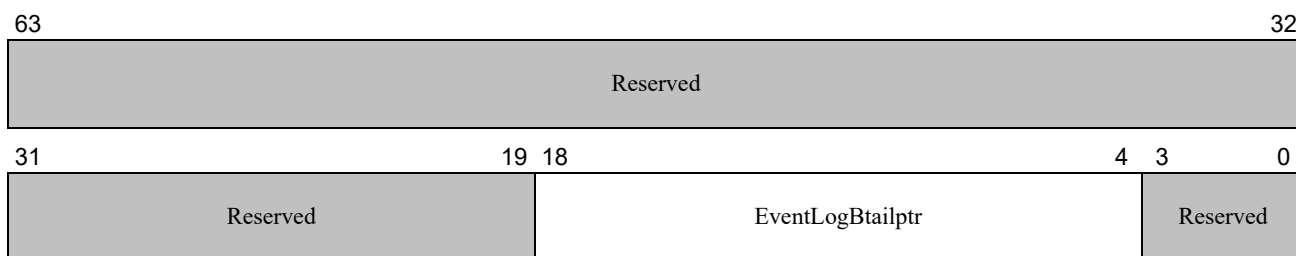

Bits	Description
63:19	Reserved.
18:4	EventLogBtailptr : Event log B tail pointer. RW. Reset 0000h. Specifies the 128 bit aligned offset from starting address of the event log specified by the Event Log B Base Register that will be written next by the IOMMU when an event is detected. The IOMMU increments this register, rolling over at the end of the buffer, after writing an event to the event log. If this register is written while EventLogRun = 1, the IOMMU behavior is undefined. If this register is set by software to a value outside the length specified by MMIO Offset 00F8h [EventLogBlen], the IOMMU behavior is undefined.
3:0	Reserved.

3.4.21 PPR Log Overflow Protection Registers

MMIO Offset 2080h PPR Log Auto Response Register

This register controls the response that is generated when a peripheral page request is received from a PCI device.

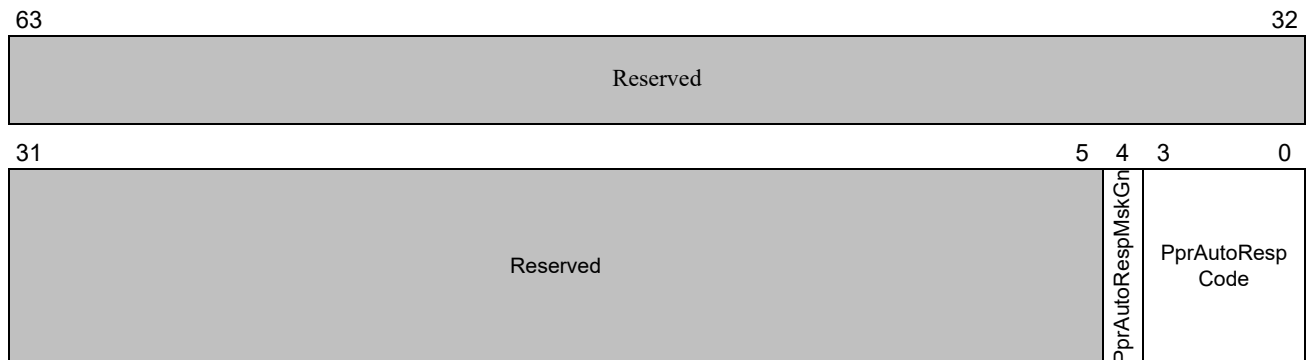

Bits	Description
63:5	Reserved.
4	PprAutoRespMskGn : PPR log Auto Response Mask Gen. RW. Reset 0.
3:0	PprAutoRespCode : PPR log Auto Response Code.

MMIO Offset 2088h PPR Log Overflow Early Indicator Register

This register is used to control the PPR Log (A) early overflow indication feature.

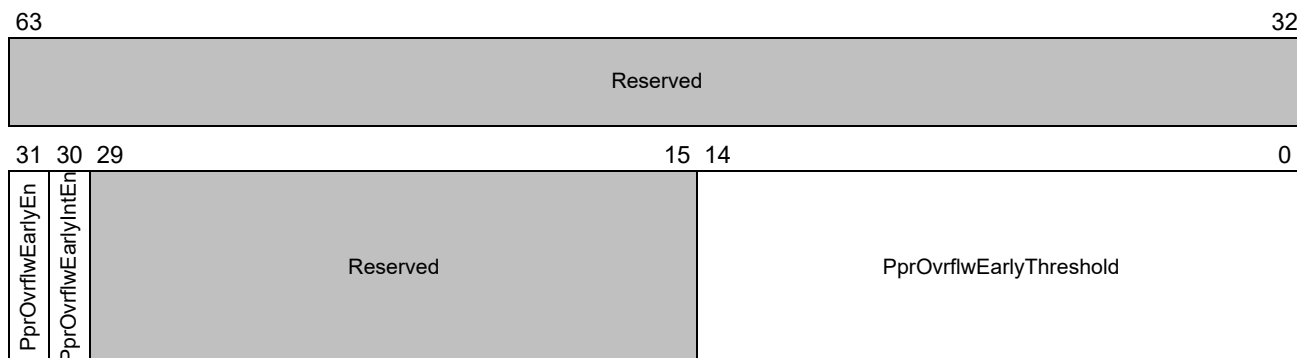

Bits	Description
63:32	Reserved.
31	PprOvrflwEarlyEn : PPR log Overflow Early indicator Enable. RW. Reset 0. 0 = PPR Log overflow early indicator mechanism is disabled. 1 = PPR Log overflow early indicator mechanism is enabled.
30	PprOvrflwEarlyIntEn : PPR log Overflow Early indicator Interrupt Enable. RW. Reset 0. 1 = an IOMMU MSI is signaled when the number of remaining entries in the PPR log is less than the programmed PprOvrflwEarlyThreshold value. 0 = an MSI is not signaled.
29:15	Reserved.
14:0	PprOvrflwEarlyThreshold : PPR log Overflow Early indicator threshold. RW. Reset 0000h. A PPR Log overflow early indication is asserted when the number of remaining entries in the PPR log is less than this value.

MMIO Offset 2090h PPR Log B Overflow Early Indicator Register

This register is used to control the PPR Log B early overflow indication feature.

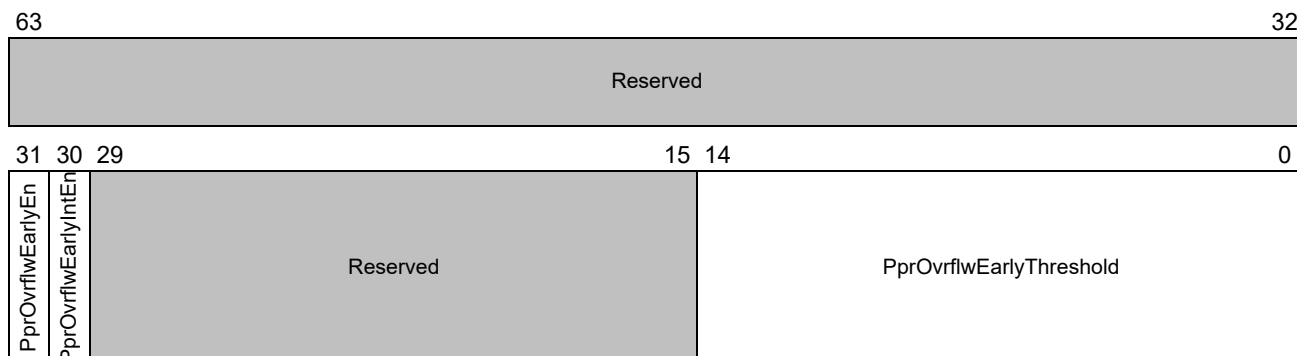

Bits	Description
63:32	Reserved.
31	PprBOvrflwEarlyEn : PPR log B Overflow Early indicator Enable. RW. Reset 0. 0 = PPR Log B overflow early indicator mechanism is disabled. 1 = PPR Log B overflow early indicator mechanism is enabled.
30	PprBOvrflwEarlyIntEn : PPR log B Overflow Early indicator Interrupt Enable. RW. Reset 0. 1 = an IOMMU MSI is signaled when the number of remaining entries in the PPR log B is less than the programmed PprOvrflwEarlyThreshold value. 0 = an MSI is not signaled.
29:15	Reserved.
14:0	PprBOvrflwEarlyThreshold : PPR log B Overflow Early indicator threshold. RW. Reset 0000h. A PPR Log B overflow early indication is asserted when the number of remaining entries in the PPR log B is less than this value.

3.4.22 IOMMU Event Counter Registers

If IOMMU Extended Feature Register [MMIO Offset 0030h][PCSup] = 0, the event counter registers are reserved.

3.4.22.1 MMIO Event Counter Control Registers

The following set of registers, MMIO Offset 4000h through MMIO Offset 4018h, control the IOMMU event counters.

MMIO Offset 4000h IOMMU Counter Configuration Register

This register reports the type and number of counters available to software.

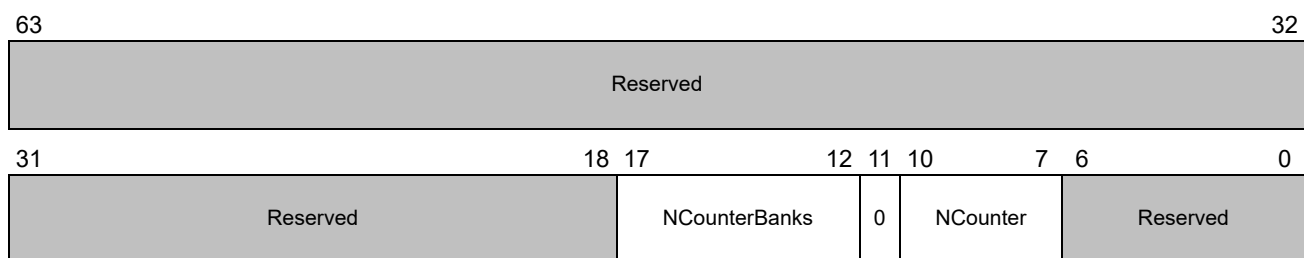

Bits	Description
63:18	Reserved.
17:12	<p>NCounterBanks[5:0]: Number of IOMMU counter banks. RO. Reset XXh. The number of counter banks supported by the IOMMU. Each bank contains two or more counter register and control registers as specified by NCounter. For each counter bank, a corresponding control bit is in IOMMU Counter PASID Bank-Lock Register [MMIO Offset 4008h], IOMMU Counter Domain Bank-Lock Register [MMIO Offset 4010h], and IOMMU Counter DeviceID Bank-Lock Register [MMIO Offset 4018h]. Each supported event counter bank is in a distinct, consecutive 4-Kbyte page. The limit of 63 counter banks is architectural and an implementation may set a lower value.</p> <p>0 = No event counter banks supported. 1–63 = The number of event counter banks supported.</p> <p>Note: IOMMU event counter banks are numbered starting with 0.</p>
11	Reserved.
10:7	<p>NCounter[3:0]: Number of counters per counter bank. RO. Reset Xh. Reports the number of individual counters in each IOMMU counter bank. Each counter bank contains the same number of counters.</p> <p>0 = No counters supported. 1 = Reserved. 2–15 = number of counters in each counter bank.</p>
6:0	Reserved.

MMIO Offset 4008h IOMMU Counter PASID Bank-Lock Register

This register locks the corresponding PASID-match register, [IOMMU PASID Match Register \[MMIO Offset \[40-7F\]\[0-F\]10h\]](#). When a PASID-match register is locked, the register can be read but writes are ignored.

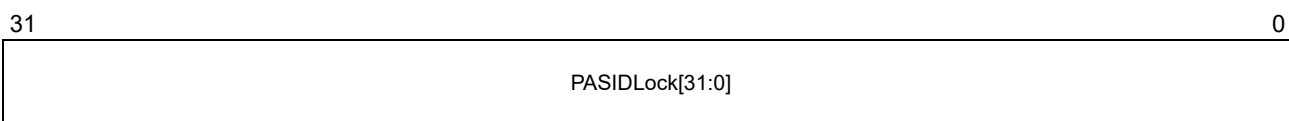
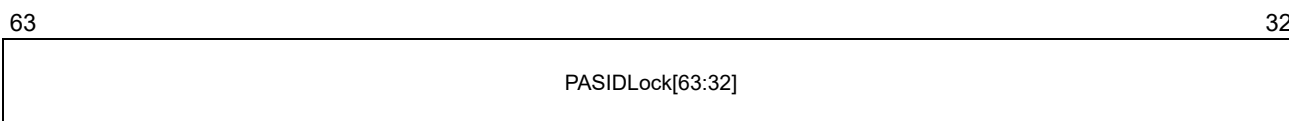

Bits	Description
63:0	<p>PASIDLock: PASID lock enable. RW. Reset 0.</p> <p>0 = Corresponding counter bank of PASID-match registers is unlocked. 1 = locked (writes are ignored).</p> <p>For each bit in PASIDLock, the corresponding PASID-match registers in an IOMMU counter bank may be changed. See IOMMU PASID Match Register [MMIO Offset [40-7F][0-F]10h]. Bit positions above the value reported in MMIO Offset 4000h[NCounterBanks] are ignored when written and return zero when read. The counter banks are numbered starting with zero; PASIDLock[0] controls bank 0, etc.</p>

Software Note: this register should be managed by trusted software.

MMIO Offset 4010h IOMMU Counter Domain Bank-Lock Register

This register locks the corresponding Domain-match counter bank registers, [IOMMU Domain Match Register \[MMIO Offset \[40-7F\]\[0-F\]18h\]](#). When a Domain-match register is locked, the register can be read but writes are ignored.

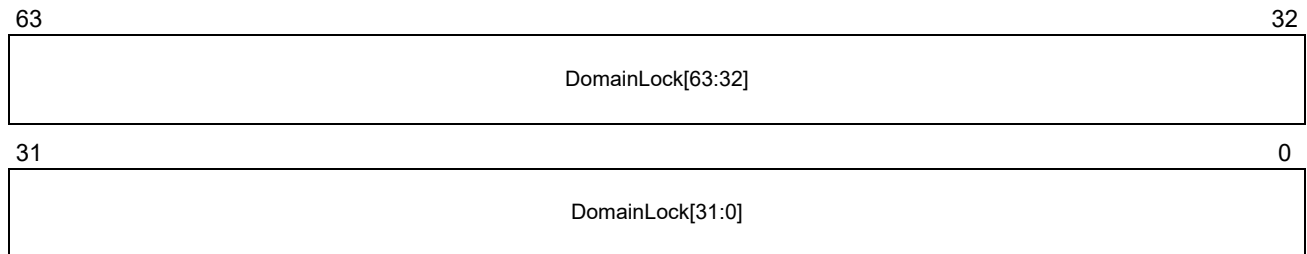

Bits	Description
63:0	<p>DomainLock: Domain lock enable. RW. Reset 0. 0 = Corresponding counter bank of Domain-match registers is unlocked. 1 = locked (writes are ignored). For each bit in DomainLock, the corresponding Domain-match registers in an IOMMU counter bank may be changed. See IOMMU Domain Match Register [MMIO Offset [40-7F][0-F]18h]. Bit positions above the value reported in MMIO Offset 4000h[NCounterBanks] are ignored when written and return zero when read. The counter banks are numbered starting with zero; DomainLock[0] controls bank 0, DomainLock[1] controls bank 1, etc.</p>

Software Note: this register should be managed by trusted software.

MMIO Offset 4018h IOMMU Counter DeviceID Bank-Lock Register

This register locks the corresponding DeviceID-match counter bank registers, [IOMMU DeviceID Match Register \[MMIO Offset \[40-7F\]\[0-F\]20h\]](#). When a DeviceID-match register is locked, the register can be read but writes are ignored.

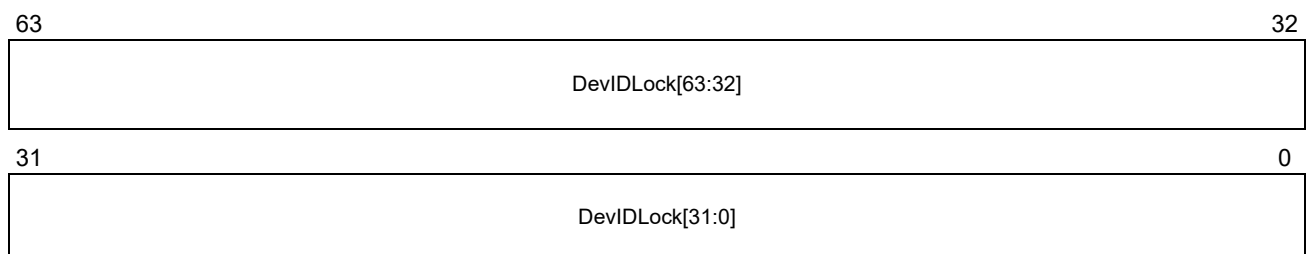

Bits	Description
63:0	DevIDLock: DeviceID lock enable. RW. Reset 0. 0 = Corresponding counter bank of DeviceID-match registers is unlocked. 1 = locked (writes are ignored). For each bit in DevIDLock, the corresponding DeviceID-match registers in an IOMMU counter bank may be changed. See IOMMU DeviceID Match Register [MMIO Offset [40-7F][0-F]20h] . Bit positions above the value reported in MMIO Offset 4000h[NCounterBanks] are ignored when written and return zero when read. The counter banks are numbered starting with zero. DevIDLock[0] controls bank 0, etc.

Software Note: This register should be managed by trusted software.

3.4.22.2 MMIO Event Counter Configuration Registers

The following set of registers, [MMIO Offset \[40-7F\]\[0-F\]00h](#) through [MMIO Offset \[40-7F\]\[0-F\]28h](#), are organized as banks of counters spaced at 4-Kbyte page boundaries. There are a variable number of counter registers and counter register banks implemented as specified in [MMIO Offset 4000h\[NCounterBanks, NCounter\]](#). The MMIO addresses are decoded as shown in [Figure 82](#).

The base address is the IOMMU MMIO base address defined by [IOMMU Base Address Low Register \[Capability Offset 04h\]](#) and [IOMMU Base Address High Register \[Capability Offset 08h\]](#). Note that the use of IOMMU event counters affects the value programmed into [IOMMU Base Address Low Register \[Capability Offset 04h\]](#).

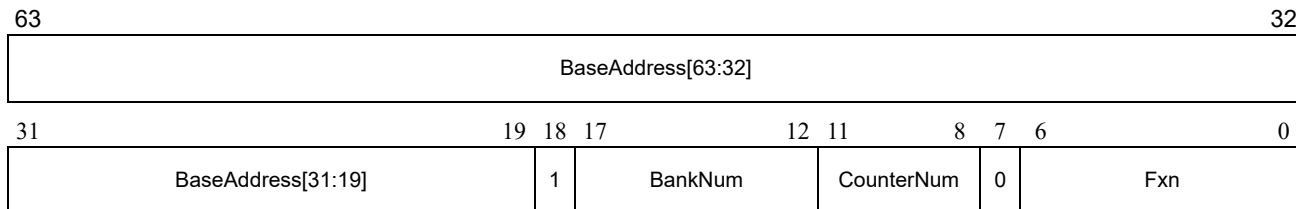

Figure 82: IOMMU Counter Register Address Decode

Table 80: Counter Bank Addressing (MMIO)

Bits	Description
63:19	BaseAddress: Equal to bits 63:19 of the IOMMU base address programmed in the IOMMU Base Address Low Register [Capability Offset 04h] and IOMMU Base Address High Register [Capability Offset 08h] registers.
18	Reserved. Must be set to 1.
17:12	BankNum: Bank number. Selects counter bank. The maximum value is defined by MMIO Offset 4000h[NCounterBanks] .
11:8	CounterNum: Counter number. Selects counter within bank. The maximum value is defined by MMIO Offset 4000h[NCounter] .
7	Reserved. Must be zero.

Table 80: Counter Bank Addressing (MMIO) (Continued)

Bits	Description
6:0	<p>Fxn: Function. This field selects the functional register within the counter set.</p> <p>+00h: IOMMU Counter Register [MMIO Offset [40-7F][0-F]00h].</p> <p>+08h: IOMMU Counter Source Register [MMIO Offset [40-7F][0-F]08h].</p> <p>+10h: IOMMU PASID Match Register [MMIO Offset [40-7F][0-F]10h].</p> <p>+18h: IOMMU Domain Match Register [MMIO Offset [40-7F][0-F]18h].</p> <p>+20h: IOMMU DeviceID Match Register [MMIO Offset [40-7F][0-F]20h].</p> <p>+28h: IOMMU Counter Report Register [MMIO Offset [40-7F][0-F]28h].</p> <p>+30h through +78h: Reserved.</p> <p>Bits 2:0 of the field must be zero.</p>

Software Note: because each counter bank is aligned to a 4-Kbyte page, the counter banks can be assigned to different guests for direct access after programming IOMMU Counter PASID Bank-Lock Register [MMIO Offset 4008h], IOMMU Counter Domain Bank-Lock Register [MMIO Offset 4010h], and IOMMU Counter DeviceID Bank-Lock Register [MMIO Offset 4018h].

MMIO Offset [40-7F][0-F]00h IOMMU Counter Register

This register counts events as programmed by IOMMU Counter Source Register [MMIO Offset [40-7F][0-F]08h] and IOMMU PASID Match Register [MMIO Offset [40-7F][0-F]10h].

When the ICounter value increments to zero, an event is optionally written to the event log (see IOMMU Counter Report Register [MMIO Offset [40-7F][0-F]28h] and Section 2.5.11 [EVENT_COUNTER_ZERO Event]) and the counter continues incrementing. To cause an interrupt at a threshold value, software must set ICounter to the 2’s complement of the desired threshold value.

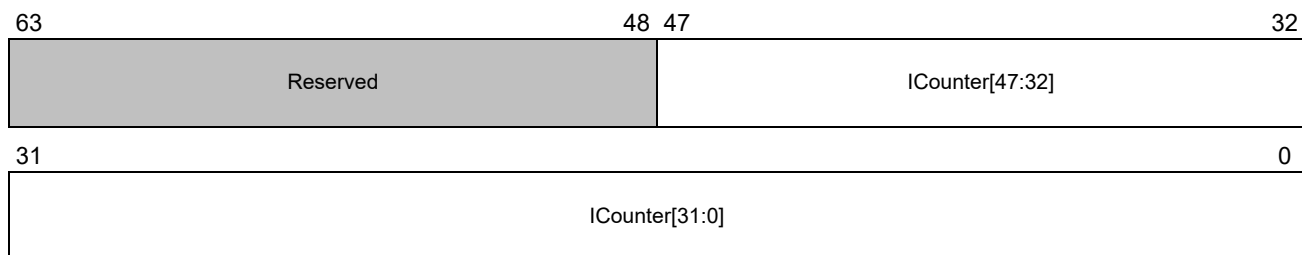

Bits	Description
63:48	Reserved.
47:28	ICounter. RW. Reset 0. Reports the counter value. The counter counts up continuously, wrapping at the maximum value and continuing to count. There is no overflow indicator.

MMIO Offset [40-7F][0-F]08h IOMMU Counter Source Register

This register selects an event source for the corresponding counter.

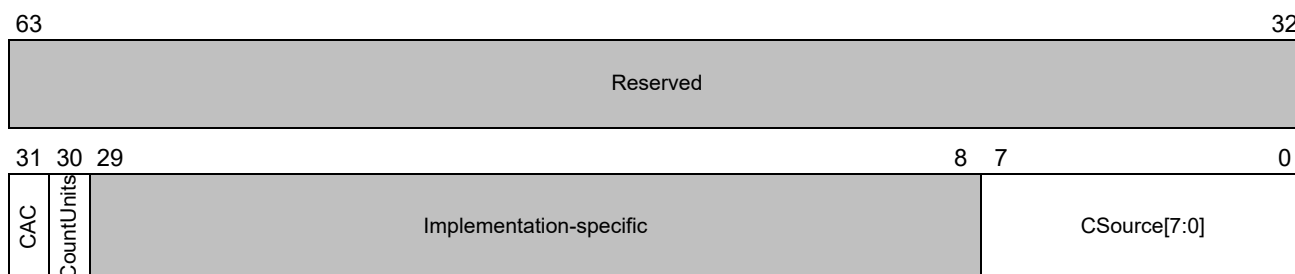

Bits	Description
63:32	Reserved.
31	CAC: Counter source architectural or custom. RW. Reset 0. Selects architectural counter input group (Table 81) or custom input group. 0 = architectural counters as defined in Table 81. 1 = implementation-defined counters. Software Note: Unless otherwise specified, selecting a counter marked Reserved returns undefined results.
30	CountUnits. RW. Reset 0. 0 = Counter counts events (level). 1 = Counter counts clocks (edges). Meaningful when CAC = 0; implementation-specific when CAC = 1.
29:8	Implementation-specific: When CAC = 0, writes to this field are ignored and reads return 0. When CAC = 1, this field is implementation-specific.
7:0	CSource: Counter source. RW. Reset 0. Selects event counter input from the choices in Table 81 when CAC = 0; selects an implementation-specific counter input when CAC = 1.

Table 81: Architectural Counter Input Group, CAC = 0b

CSource (decimal)	Architectural Counter Input Group Selection
0	No events. <i>Note: CountUnits = 0 stops the counter and CountUnits = 1 is a free-run counter.</i>
1	Peripheral memory operations passed-through, untranslated.
2	Peripheral memory operations passed-through, pretranslated.
3	Peripheral memory operations passed-through, via Exclusion Range.
4	Peripheral memory operations target aborted.
5	Peripheral memory operations translated, total.
6	Peripheral memory operations translated, IOMMU TLB hit PTE.
7	Peripheral memory operations translated, IOMMU TLB missed PTE.
8	Peripheral memory operations translated, IOMMU TLB hit PDE.
9	Peripheral memory operations translated, IOMMU TLB missed PDE.
10	Peripheral memory operations, DTE cache hit.
11	Peripheral memory operations, DTE cache miss.
12	IOMMU page table read operations due to memory translation, total.
13	IOMMU page table read operations due to memory translations, nested.
14	IOMMU page table read operations due to memory translations, guest.
15	Peripheral interrupt operations remapped, DTE cache hit.
16	Peripheral interrupt operations remapped, DTE cache miss.
17	IOMMU commands processed (total).
18	IOMMU commands processed, invalidations (total).
19	IOMMU TLB invalidations (total).
20	Reads and writes from/to IOMMU Reserved Register [MMIO Offset 1FF8h] that are ignored.
21	Peripheral interrupts for guest virtual APIC, IRTE[GuestMode] = 0b (see Figure 17 on page 92 and Table 22 on page 92).
22	Peripheral interrupts for guest virtual APIC, IRTE[GuestMode] = 1b (see Figure 18 on page 93 and Table 23 on page 94).
23	SMI interrupt requests received (see Section 2.1.5.2 [SMI Filter Address Format]).
24	SMI interrupt requests matched and blocked (see Section 2.1.5.1 [SMI Filter Operation]).
25-255	Reserved (treated as CSource = 0 and CountUnits = 0).

The IOMMU Counter Register [MMIO Offset [40-7F][0-F]00h] is incremented when IOMMU PASID Match Register [MMIO Offset [40-7F][0-F]10h], IOMMU Domain Match Register [MMIO Offset [40-7F][0-F]18h], and IOMMU DeviceID Match Register [MMIO Offset [40-7F][0-F]20h] match or are ignored.

MMIO Offset [40-7F][0-F]10h IOMMU PASID Match Register

This register contains the PASID filter mask and the PASID for which to count events in the corresponding counter register. The incoming PASID is ANDed with the PASIDMask field and the result is compared to the PASIDMatch field. If the comparison result is the same value, the event is enabled to be counted in the corresponding counter.

63	52 51	48 47	32
Reserved		PASIDMask	
31 30	20 19	16 15	0
PASMEN	Reserved		PASIDMatch

Bits	Description
63:52	Reserved
51:32	PASIDMask. RW. Reset 0. This bit-mask is ANDed with the PASID of the transaction to decide to count the corresponding event. 0 = count events for all values of incoming PASID. 0_0001h–F_FFFFh = bit-wise mask ANDed with incoming PASID.
31	PASMEN: PASID match enable. RW. Reset 0. 0 = PASID is ignored. 1 = Filtered PASID must match to count an event. An event with no PASID tag is only counted when PASMEN = 0.
30:20	Reserved.
19:0	PASIDMatch. RW. Reset 0. This value is compared to the masked (filtered) value of the incoming PASID of the transaction to decide to count the corresponding event. The event is counted if PASIDMatch is equal to the masked incoming PASID; the event is not counted if they are not equal.

MMIO Offset [40-7F][0-F]18h IOMMU Domain Match Register

This register contains the Domain filter mask and the Domain for which to count events in the corresponding counter register. The incoming Domain is ANDed with the DomainMask field and the result is compared to the DomainMatch field. If the comparison result is the same value, the event is enabled to be counted in the corresponding counter.

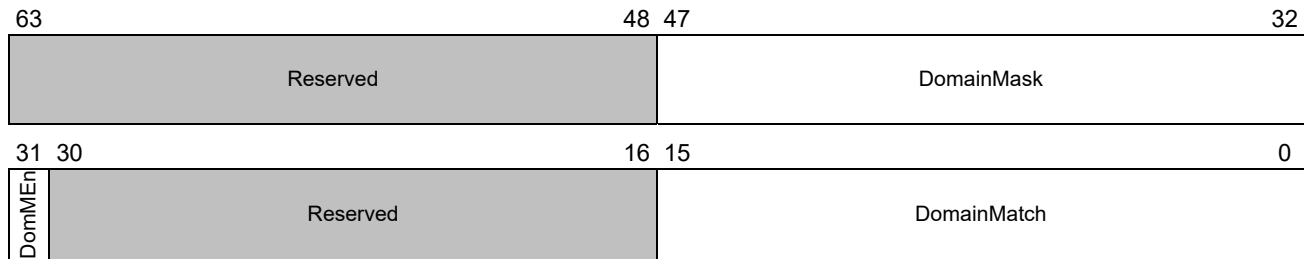

Bits	Description
63:48	Reserved.
47:32	DomainMask. RW. Reset 0. This bit-mask is ANDed with the Domain of the transaction to decide to count the corresponding event. 0 = count events for all values of incoming Domain. 0001h–FFFFh = bit-wise mask ANDed with incoming Domain.
31	DomMEen: Domain match enable. RW. Reset 0. 0 = Domain is ignored. 1 = Filtered. Domain must match to count an event.
30:16	Reserved.
15:0	DomainMatch. RW. Reset 0. This value is compared to the masked (filtered) value of the incoming Domain of the transaction to decide to count the corresponding event. The event is counted if DomainMatch is equal to the masked incoming PASID; the event is not counted if they are not equal.

MMIO Offset [40-7F][0-F]20h IOMMU DeviceID Match Register

This register contains the DeviceID filter mask and the DeviceID for which to count events in the corresponding counter register. The incoming DeviceID is ANDed with the DeviceIDMask field and the result is compared to the DeviceIDMatch field. If the comparison result is the same value, the event is enabled to be counted in the corresponding counter.

63	Reserved	48 47	DeviceIDMask	32
31 30	Reserved	16 15	DeviceIDMatch	0
DIDMEN				

Bits	Description
63:48	Reserved.
47:32	DeviceIDMask. RW. Reset 0. This bit-mask is ANDed with the DeviceID of the transaction to decide to count the corresponding event. 0 = count events for all values of incoming DeviceID. 0001h-FFFFh = bit-wise mask ANDed with incoming DeviceID.
31	DIDMEN: DeviceID match enable. RW. Reset 0. 0 = DeviceID is ignored. 1 = Filtered DeviceID must match to count an event.
30:16	Reserved.
15:0	DeviceIDMatch. RW. Reset 0. This value is compared to the masked (filtered) value of the incoming DeviceID of the transaction to decide to count the corresponding event. The event is counted if DeviceIDMatch is equal to the masked incoming DeviceID; the event is not counted if they are not equal.

MMIO Offset [40-7F][0-F]28h IOMMU Counter Report Register

This register hold information for the optional event log entry generated when the event counter wraps to zero. The counters continue to count after they wrap to zero.

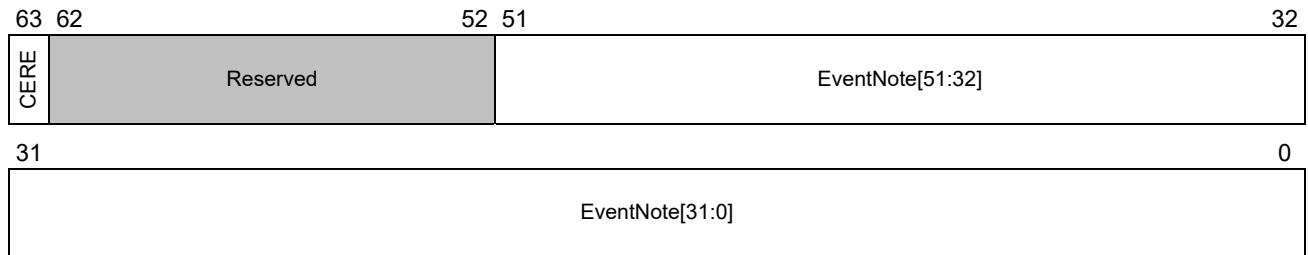

Bits	Description
63	<p>CERE: Counter Event Report Enable. RW. Reset 0. 0 = no event report when counter wraps to zero. 1 = IOMMU writes an EVENT_COUNTER_ZERO event log entry when the counter wraps to zero. The counter-wrap event is treated like any other event (see Section 2.5 [Event Logging]).</p> <p><i>Software Note: the counter-wrap event is delivered promptly but without a latency guarantee.</i></p>
62:52	Reserved.
51:0	<p>EventNote. RW. Reset 0_0000_0000_0000h. When CERE = 1 and the corresponding counter is incremented and wraps to zero, EventNote[51:0] is reported in the EVENT_COUNTER_ZERO event log entry (see Section 2.5.11 [EVENT_COUNTER_ZERO Event]).</p>

3.5 IOMMU Virtual Function Controls MMIO Registers

The IOMMU Virtual Function Control MMIO registers are mapped using the IOMMU Virtual Function Control Base Address Low Register and IOMMU Virtual Function Control Base Address High Register. Software access to IOMMU Virtual Function Controls MMIO registers using either 1DW or 2DW access. Access address must be size aligned.

Each guest takes up a contiguous 64B space in this region which aligned to 64B address. GuestID is a 16-bit value.

VFCntMMIO Offset {16'b[GuestID], 6'b00_0000} Guest Device Map Control Register

Software must program this register as a single 2DW access or program the lower DW follow immediately by upper DW before programming other registers.

The register defines the mapping between the guest Device ID and the system Device ID. If the guest owns N number of devices, software must program this register N times with W=1 to cycle through the N guest device ID and its corresponding system DeviceID and QueueID.

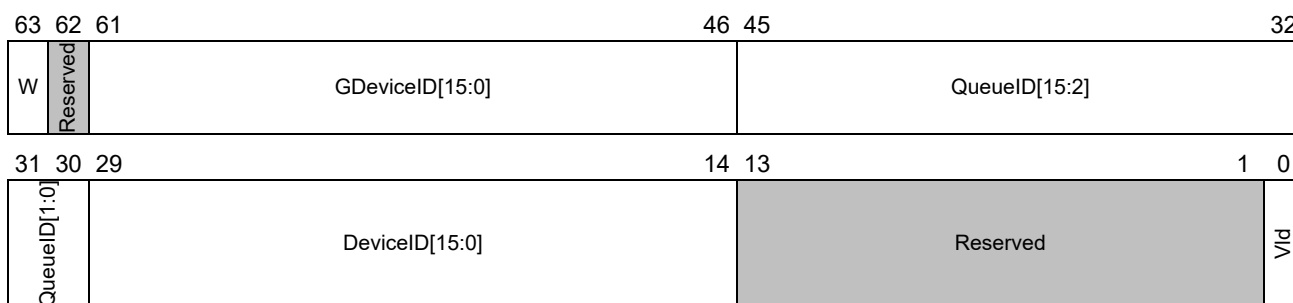

Bits	Description
63	W. Write-Only. Commit the programming of DeviceID mapping across the 2DW.
62	Reserved
61:46	GDeviceID[15:0]. The guest device ID.
45:30	QueueID[15:0]. The Queue ID across the system in Invalidate IOTLB Page command. This is used in IOMMU to limit the number of outstanding iotlb invalidations to a given queue.
29:14	DeviceID[15:0]. The system device ID.
13:1	Reserved
0	Vld. Indicate the device mapping for the guest is valid.

VFCntMMIO Offset {16'b[GuestID], 6'b00_1000} Guest Domain Map Control Register

Software must program this register as a single 2DW access or program the lower DW follow immediately by upper DW before programming other registers.

The register defines the mapping between the guest Domain ID and the system Domain ID. If the

guest has N number of domain, software must program this register N times with W=1 to cycle through the N guest domain ID and its corresponding system DomainID.

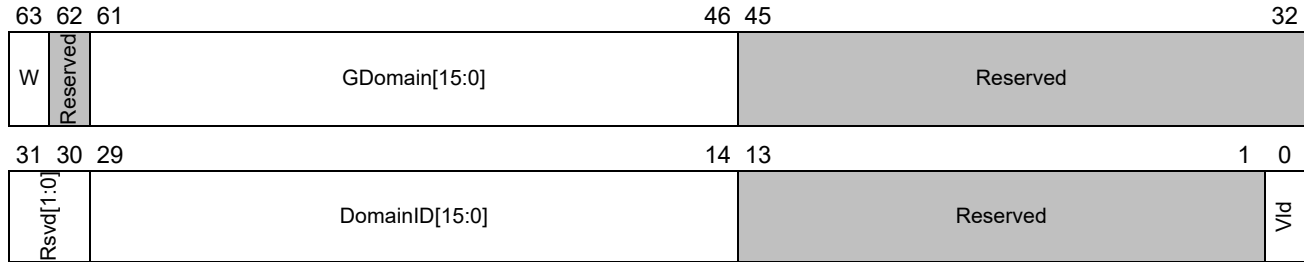

Bits	Description
63	W. Write-Only. Commit the programming of DeviceID mapping across the 2DW.
62	Reserved
61:46	GDeviceID[15:0]. The guest domain ID.
45:30	Reserved
29:14	DeviceID[15:0]. The system domain ID.
13:1	Reserved
0	Vld. Indicate the domain mapping for the guest is valid.

VFCntMMIO Offset {16'b[GuestID], 6'b01_1000} Guest Event LogB Buffer Control Register

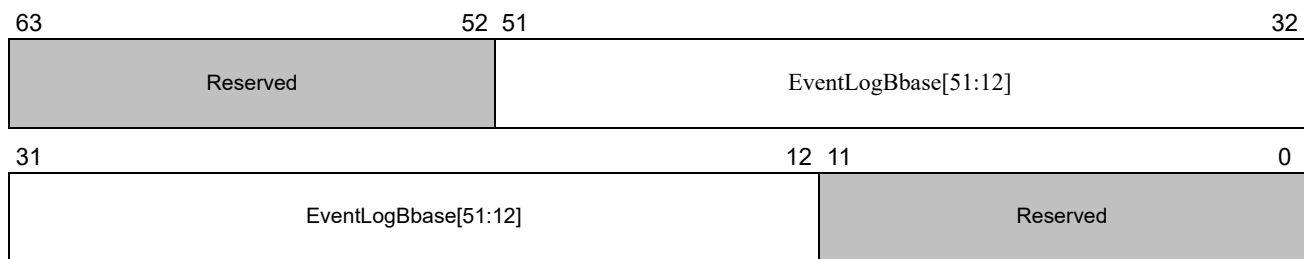

Bits	Description
63:52	Reserved
51:12	EventLogBbase[51:12]. Specifies the Guest Physical Base Address of Guest Event LogB Buffer. The GPA will be translated to an SPA by the IOMMU using the Guest's nested page table. (See Section 2.2.3, “I/O Page Tables for Host Translations” on page 77.) The base address must be aligned to 4KB. This field is reserved with MMIO Offset 0018h[GstBufferTRPMode]=0.
11:0	Reserved

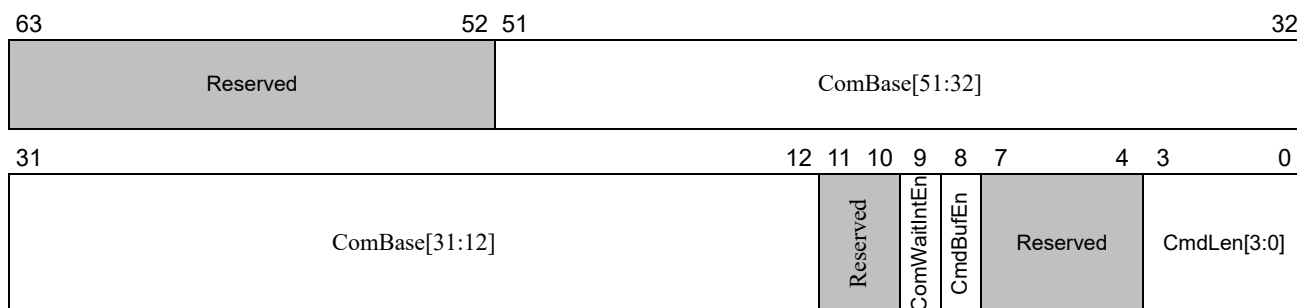
VFCntMMIO Offset {16'b[GuestID], 6'b10_0000} Guest Command Control Register

Bits	Description
63:52	Reserved
51:12	ComBase[51:12] : Specifies the Guest Physical Base Address of Guest Command Buffer. The GPA will be translated to an SPA by the IOMMU using the Guest's nested page table. (See Section 2.2.3, “I/O Page Tables for Host Translations” on page 77.) The base address must be aligned to 4KB. This field is reserved with MMIO Offset 0018h[GstBufferTRPMode]=0.
11:10	Reserved
9	ComWaitIntEn : Completion wait interrupt enable for this guest. Refer to IOMMU MMIO Offset 0018h[CmWaitIntEn].
8	CmdBufEn : Command buffer enable for this guest. Refer to IOMMU MMIO Offset 0018h[CmdBufEn].
7:4	Reserved
3:0	CmdLen : Command buffer length for this guest. Refer to IOMMU MMIO Offset 0008h[ComLen].

VFCntMMIO Offset {16'b[GuestID], 6'b10_1000} Guest Event Control Register

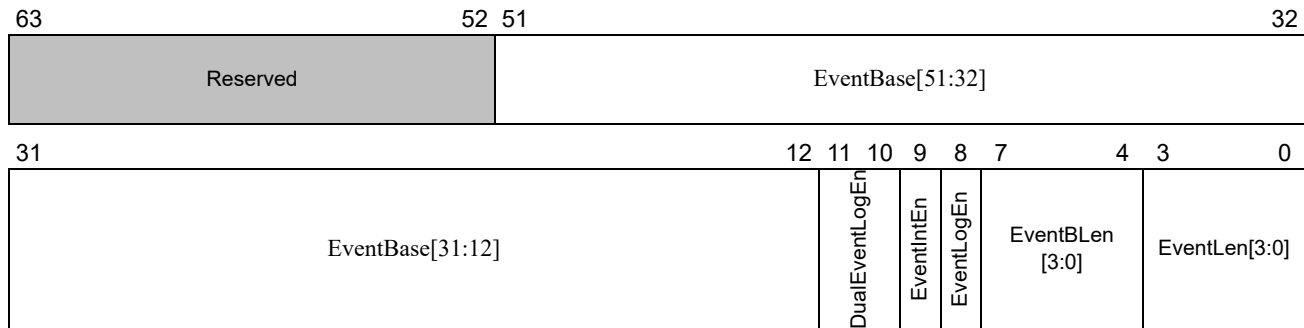

Bits	Description
63:52	Reserved
51:12	EventBase[51:12]: Specific the Guest Physical Base Address of Guest Event Log Buffer. The GPA will be translated to an SPA by the IOMMU using the Guest's nested page table. (See Section 2.2.3, "I/O Page Tables for Host Translations" on page 77.) The base address must be aligned to 4KB. This field is reserved with MMIO Offset 0018h[GstBufferTRPMode]=0.
11:10	DualEventLogEn: Dual event log enable for this guest. Refer to IOMMU MMIO Offset 0018h[DualEventLogEn].
9	EventIntEn: Event log interrupt enable for this guest. Refer to IOMMU MMIO Offset 0018h[EventIntEn].
8	EventLogEn: Event log enable for this guest. Refer to IOMMU MMIO Offset 0018h[EventLogEn].
7:4	EventBLen: Event log B length for this guest. Refer to IOMMU MMIO Offset 00F8h[EventLogBLen].
3:0	EventLen: Event log length for this guest. Refer to IOMMU MMIO Offset 0010h[EventLen].

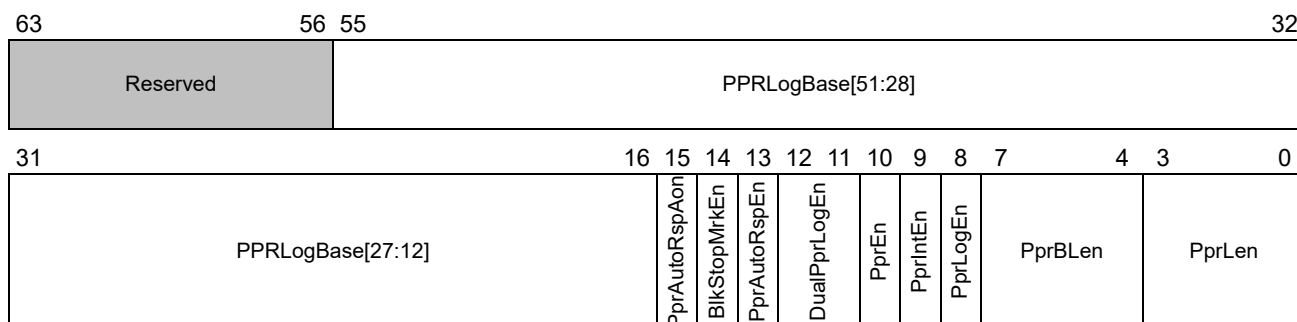
VFCntMMIO Offset {16'b[GuestID], 6'b11_0000} Guest PPR Control Register

Bits	Description
63:56	Reserved
55:16	PPRLogBase[51:12]: Specific the Guest Physical Base Address of Guest PPR Log Buffer. The GPA will be translated to an SPA by the IOMMU using the Guest's nested page table. (See Section 2.2.3, “I/O Page Tables for Host Translations” on page 77.) The base address must be aligned to 4KB. This field is reserved with MMIO Offset 0018h[GstBufferTRPMode]=0.
15	PprAutoRspAon: Peripheral Page Request Auto Response for this guest. Refer to IOMMU MMIO Offset 0018h[PprAutoRspAon] .
14	BlkStopMrkEn: Block StopMark message feature enable for this guest. Refer to IOMMU MMIO Offset 0018h[BlkStopMrkEn] .
13	PprAutoRspEn: Peripheral Page Request Automatic Response feature enable for this guest. Refer to IOMMU MMIO Offset 0018h[PprAutoRspEn] .
12:11	DualPprLogEn: Dual Peripheral Page Request Log enable for this guest. Refer to IOMMU MMIO Offset 0018h[DualPprLogEn] .
10	PprEn: Peripheral page request processing enable for this guest. Refer to IOMMU MMIO Offset 0018h[PPREn] .
9	PprIntEn: Peripheral page request interrupt enable for this guest. This value contains the guest vIOMMU MMIO Offset 0018h[PprIntEn] .
8	PprLogEn: Peripheral page request log enable for this guest. Refer to IOMMU MMIO Offset 0018h[PPRLogEn] .
7:4	PprBLen: Peripheral page Request B log length for this guest. Refer to IOMMU MMIO Offset 00F0h[PprBLen] .
3:0	PprLen: Peripheral page request log length for this guest. Refer to IOMMU MMIO Offset 0038h[PPRLogLen] .

VFCntMMIO Offset {16'b[GuestID], 6'b11_1000} Guest PPRB Control Register

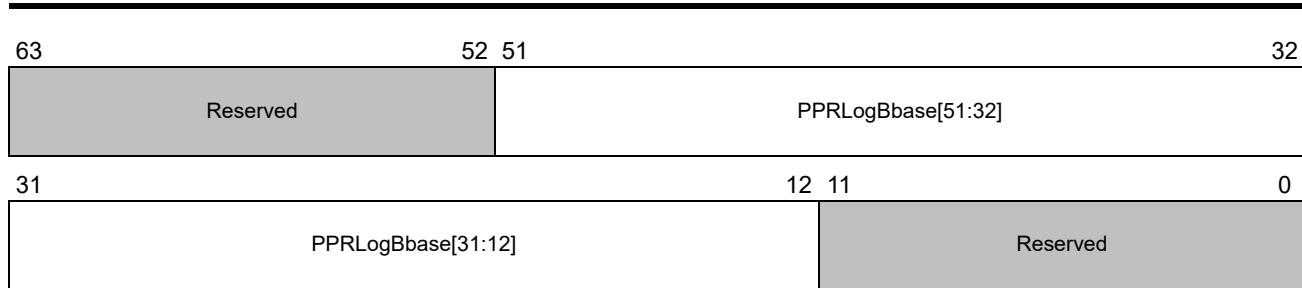

Bits	Description
63:52	Reserved
51:12	PPRLogBbase[51:12]: Specifies the Guest Physical Base Address of Guest PPRLogB Buffer. The GPA will be translated to an SPA by the IOMMU using the Guest's nested page table. (See Section 2.2.3, “I/O Page Tables for Host Translations” on page 77.) The base address must be aligned to 4KB. This field is reserved with MMIO Offset 0018h[GstBufferTRPMode]=0.
11:0	Reserved

3.6 IOMMU Virtual Function MMIO Registers

The IOMMU Virtual Function MMIO region contains all the Command/Event Log/PPR Pointer Registers, Command/Event Log/PPR Log Status Registers and PPR Overflow Protection Registers for all the guests.

Each guest takes up a contiguous 4K space in this region which aligned to 4K address. GuestID is a unique 16-bit value associated with a Guest VM.

VFMMIO Offset {16'b[GuestID], 12'h0000h} Command Buffer Head Pointer Register for GuestID.
(Register definition is the same as [MMIO Offset 2000h](#).)

VFMMIO Offset {16'b[GuestID], 12'h0008h} Command Buffer Tail Pointer Register for GuestID.
(Register definition is the same as [MMIO Offset 2008h](#).)

VFMMIO Offset {16'b[GuestID], 12'h0010h} Event Log Head Pointer Register for GuestID.
(Register definition is the same as [MMIO Offset 2010h](#).)

VFMMIO Offset {16'b[GuestID], 12'h0018h} Event Log Tail Pointer Register for GuestID.
(Register definition is the same as [MMIO Offset 2018h](#).)

VFMMIO Offset {16'b[GuestID], 12'h0020h} vIOMMU Status Register for GuestID.

(Register definition is the same as [MMIO Offset 2020h](#) except bit 10:8 are marked as reserved.)

VFMMIO Offset {16'b[GuestID], 12'h0030h} IOMMU PPR Log Head Pointer Register for GuestID.

(Register definition is the same as [MMIO Offset 2030h](#).)

VFMMIO Offset {16'b[GuestID], 12'h0038h} IOMMU PPR Log Tail Pointer Register for GuestID.

(Register definition is the same as [MMIO Offset 2038h](#).)

VFMMIO Offset {16'b[GuestID], 12'h0040h} Reserved.

VFMMIO Offset {16'b[GuestID], 12'h0048h} Reserved.

VFMMIO Offset {16'b[GuestID], 12'h0050h} PPR Log B Head Pointer Register for GuestID.

(Register definition is the same as [MMIO Offset 2050h](#).)

VFMMIO Offset {16'b[GuestID], 12'h0058h} PPR Log B Tail Pointer Register for GuestID.

(Register definition is the same as [MMIO Offset 2058h](#).)

VFMMIO Offset {16'b[GuestID], 12'h0070h} Event Log B Head Pointer Register for GuestID.

(Register definition is the same as [MMIO Offset 2070h](#).)

VFMMIO Offset {16'b[GuestID], 12'h0078h} Event Log B Tail Pointer Register for GuestID.

(Register definition is the same as [MMIO Offset 2078h](#).)

VFMMIO Offset {16'b[GuestID], 12'h0080h} PPR Log Auto Response Register for GuestID.

(Register definition is the same as [MMIO Offset 2080h](#).)

VFMMIO Offset {16'b[GuestID], 12'h0088h} PPR Log Overflow Early Indicator Register for GuestID.

(Register definition is the same as [MMIO Offset 2088h](#).)

VFMMIO Offset {16'b[GuestID], 12'h0090h} PPR Log B Overflow Early Indicator Register for GuestID.

(Register definition is the same as [MMIO Offset 2090h](#).)

4 Implementation Considerations

This chapter discusses issues that are primarily of concern to IOMMU implementers.

The IOMMU specification is intended to allow a wide range of implementations with different cost and performance trade-offs. Potential implementation technology may range from ASIC to full custom. Capacity and organization of the IOMMU's translation caches can vary substantially depending on technology, die budgets, and product requirements. The IOMMU can be integrated with a chipset (typically as part of some existing interconnect bridge) or built as a standalone component (which can act as a HyperTransport™ bridge or tunnel).

4.1 Caching and Invalidation Strategies

All IOMMU implementations should have some form of translation cache that allows the IOMMU to determine the disposition of device accesses quickly without having to re-walk the IOMMU tables for each separate device access. The translation cache is likely to be the largest portion of the IOMMU's die area budget in all but the smallest implementations. Consequently the IOMMU specification has been written to allow flexibility in the design of the translation cache.

Plausible implementations range from direct mapped RAM structures to fully associative CAM structures, with the expectation that most implementations are set associative. Furthermore, implementers may choose to flatten the multi-stage IOMMU table walk into a single cache array lookup, or, alternatively, may choose to use a similar multi-stage organization for internal translation cache lookups.

The IOMMU's translation cache must support the following operations:

- **Lookup** — when the IOMMU processes an access by a particular device to a specified DVA, it applies protection checks and translation transformations using information obtained using DeviceID and DVA.
- **Invalidate device** — discard any translation cache contents that depend on a specific Device Table entry.
- **Invalidate virtual address (within domain)** — discard any cached translations for a virtual address within the specified domain.

Typical IOMMU implementations are likely to be built with ASIC design flows, where CAM cells are expensive compared to RAM cells. The main implication of this is that direct support for different page sizes is likely to require a combination of separate arrays and/or multiple entries within arrays, causing both fills and invalidations to require time-consuming search-and-destroy algorithms.

The IOMMU is designed to support three main usage models:

- Direct user process access to a single device like a graphics controller;
- Direct virtual machine guest access to a collection of devices that have been dedicated to that guest; and
- A single non-virtualized OS using the IOMMU to enforce device to system memory access controls.

When a user process directly controls a single device, the total memory footprint for the device's accesses is likely to be a modest fraction of the process's own memory footprint. Moreover, the user process has direct knowledge of the specific device, so there is a good chance that the device's access pattern is controllable for good locality. In this case the main consideration for achieving performance is to ensure that the IOMMU translation cache is large enough.

By contrast, the potential memory footprint of a virtual machine guest's devices is the entire memory of the guest. Often the access pattern may be poorly controlled, as determined by the guest operating system's workload (of which the HV likely has no specific knowledge), and, moreover, consists of interactions with a variety of devices under the control of different guest device drivers and subsystems, with diverse memory allocation strategies. In the case of a non-paravirtualized guest, a HV's strategy for improving performance is probably to set up I/O page tables using the largest available page size and assume that the IOMMU can share the same translation cache entries among multiple devices. It is for this reason that the IOMMU table structure includes a *DomainID* that can be shared for multiple *DeviceIDs*: since the IOMMU uses translation cache entries tagged by *{DomainID, I/O virtual address}* it automatically shares translations among multiple devices assigned to the same domain.

Based on these considerations, designers should consider a two-stage organization for the IOMMU translation cache:

- The first stage should map *DeviceID* to *{DomainID, I/O page table base address}*. Most systems have only a few distinct *DeviceIDs*, so the capacity of the first stage can be small. The one complication is that *DeviceIDs* are not very random and tend to be clustered, so, to avoid conflicts, this stage should either be highly associative or use a good *DeviceID* hash function.
- The second stage should map *{DomainID, DVA}* to *{system physical address, protection}*. This stage should have (at least) hundreds of entries. This stage should explicitly include the *DomainID* in set index hashing (rather than just using the *DomainID* as a tag), so that different domains with similar memory layouts do not compete for the same translation cache entries. (Server consolidation environments are likely to create many domains with very similar memory layouts.)

In addition, since the latency of IOMMU access to system memory can be high, implementers should consider a *page directory cache (PDC)* to accelerate processing of translation cache misses. This cache should map *{DomainID, DVA}* to *page directory entry (PDE)*, so that the IOMMU can quickly calculate the address of the final PTE needed to resolve a translation cache miss. This way, most translation cache misses can be resolved in a single memory access by the IOMMU, rather than requiring a full multi-stage table walk. The page directory cache could also double as a large-page translation cache, since for large pages the PDE is also the PTE.

4.2 IOMMU Topologies

The IOMMU's architecture is designed to accommodate a variety of system fabrics and topologies. There can be multiple IOMMUs, located at a variety of places in the system fabric. Some requestor ID information can be lost at bridges between busses or bus types, so it is advantageous to locate IOMMUs in bridges. The mapping of bus requesterIDs to IOMMU *DeviceIDs* depends on both the

bus type as well as the IOMMU's location in the system fabric. In most other respects, the IOMMU's behavior is bus-independent.

The most basic implementation of the IOMMU takes the form of a HyperTransport™ tunnel.

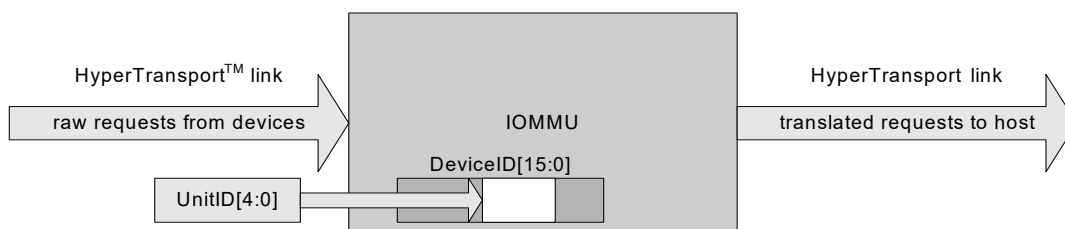

Figure 83: IOMMU in a Tunnel

The advantage of this approach is that it can be easily retrofitted to an existing system design. The main limitation of this approach is that the HyperTransport™ specification defines only 5 bits of UnitID information to identify the originators of requests, so the IOMMU can provide distinct translations for at most 31 downstream devices. If downstream nodes include any bridges, the IOMMU is unable to distinguish between different devices beyond the bridges, since bridged requests use the UnitID of the bridge.

A possible solution is to include a separate IOMMU on each downstream bus; each IOMMU can then be programmed not to rewrite transactions whose UnitID proves they have already passed through another IOMMU. Software must understand the system topology to correctly coordinate multiple IOMMUs. If a downstream HyperTransport device is a PCIe® root complex or a PCI-X® host bridge, the device can implement the RequesterID mapping capability to assign specific UnitIDs to PCIe or PCI-X devices.

An IOMMU implemented in a PCIe- or PCI-X-to-HyperTransport bridge can exploit the larger PCIe or PCI-X RequesterID namespace to provide better discrimination between downstream devices when translating requests:

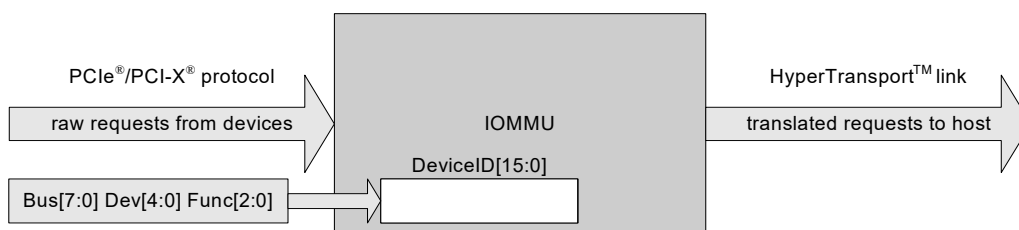

Figure 84: IOMMU in a Peripheral Bus Bridge

Since most future commodity devices are expected to be on a PCIe bus, this is likely to be the most common implementation of the IOMMU for low-cost systems.

Large systems may want a scalable IOMMU building block. Such systems may choose to implement a hybrid HyperTransport tunnel / PCIe root complex component or a HyperTransport tunnel / PCI-X host bridge component combining the above ideas:

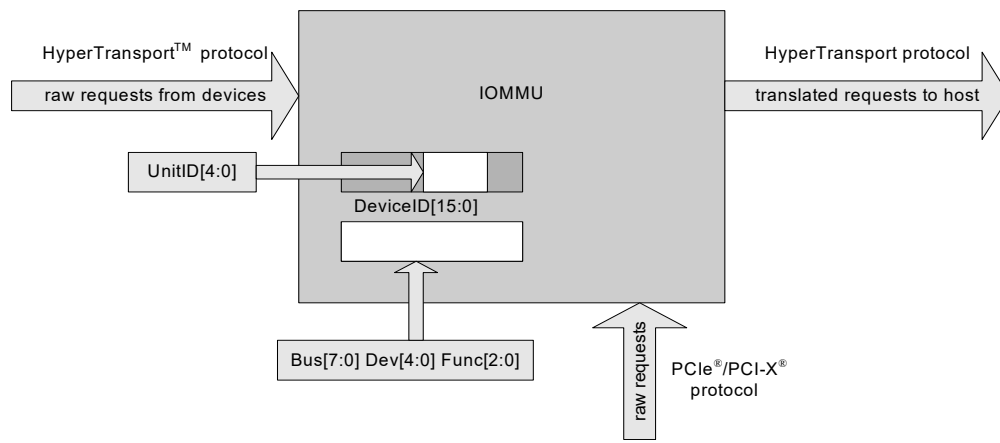

Figure 85: Hybrid IOMMU

Hybrid IOMMUs can be chained together to build large systems:

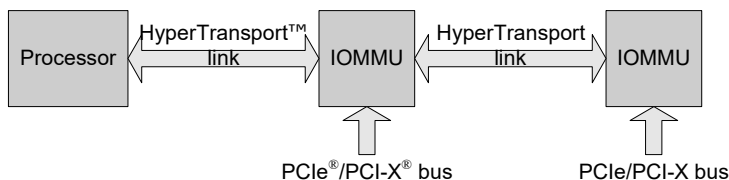

Figure 86: Chained Hybrid IOMMU in a Large System

4.3 Issues Specific to the HyperTransport™ Architecture

This section discusses implementation considerations that are specific to IOMMUs attached to a HyperTransport link.

The HyperTransport specification requires devices (especially tunnels and bridges) to interoperate with other devices in ways that ensure correctness and maintain performance. Among other requirements, HyperTransport devices must make certain transaction ordering guarantees and must ensure they operate without deadlocks.

A key requirement in the HyperTransport specification is that posted requests must be able to pass non-posted requests. The introduction of the IOMMU, however, means that posted requests (e.g. writes to memory) may spawn non-posted requests (I/O page table walks) that must complete before the posted request can be allowed to progress further.

To avoid deadlocks, the IOMMU requires a dedicated virtual channel for its I/O page table walk requests. This ensures that, the IOMMU's page table walks on behalf of posted requests can com-

plete, regardless of the completion status of other non-posted traffic in the fabric. The IOMMU also requires that the host bridge process its requests without spawning any requests to other devices. In other words, the IOMMU's table structures must be located solely in system memory.

The IOMMU can share its virtual channel with other traffic as long the other traffic is also guaranteed to make forward progress. In practice, this means that any other devices sharing the IOMMU's page walk channel must also restrict their non-posted traffic solely to accessing system memory.

To allow the IOMMU to support different AMD processors with different isochronous capabilities the IOMMU control registers contain bits that control the state of the PassPW bits, the coherent bit and the isochronous bit in the HyperTransport™ link read request issued by the IOMMU.

4.4 Chipset Specific Implementation Issues

Chipsets that implement both an IOMMU and a legacy PCI or AGP bridge must provide source identification to identify uniquely DMA traffic as originating from the PCI or AGP bus. To provide this identification, the IOMMU must use the requesterID of the PCI or AGP bridge to perform translations for DMA transactions from the legacy bus. The Device legacy ID information must be reported via appropriate ACPI or Device Tree table entries. Details are in [Section 5.2.2 \[I/O Virtualization Definition Blocks\]](#).

4.5 Software and Platform Firmware Implementation Issues

Because of the flexible architecture of the IOMMU, it is unlikely that any single system software implementation uses all the features, topologies, or options. The following constraints are strongly recommended:

- An IOMMU should be a root-complex device (i.e., appear directly on the bus at the top of the PCI tree hierarchy).
- Some system software may prohibit an IOMMU from appearing under a PCI-to-PCI bridge.
- To ensure the IOMMU is recognized and configured properly, the platform firmware should perform the initial configuration of the IOMMU so that it is accessible to system software when control is handed off by the platform firmware.
- The platform firmware should describe the IOMMU in an ACPI table as defined in [Chapter 5, "I/O Virtualization ACPI Table"](#). The table must include all information necessary to identify, configure, and access the IOMMU. It is recommended that System software retrieves IOMMU hardware information from ACPI and Firmware tables, in descending order of priority from Type11h table, if not available to Type10h IVHD tables, finally evaluating IOMMU MMIO feature registers if no other property is available or accessible.
- System firmware must ensure the IOMMU configuration is preserved or restored across power-management state changes.

5 I/O Virtualization ACPI Table

The architecture defines an ACPI-compatible data structure called an I/O Virtualization Reporting Structure (IVRS) that is used to convey information related to I/O virtualization to system software. The IVRS describes the configuration and capabilities of the IOMMUs contained in the platform as well as information about the devices that each IOMMU virtualizes.

The IVRS provides information about the following:

- IOMMUs present in the platform including their capabilities and proper configuration
- System I/O topology relevant to each IOMMU
- Peripheral devices that cannot be otherwise enumerated
- Memory regions used by SMI/SMM, platform firmware, and platform hardware. These are generally exclusion ranges to be configured by system software.

Software Implementation Note: Information conveyed in the IVRS overrides the corresponding information available through the IOMMU hardware registers. System software is required to honor the ACPI settings.

The IVRS is created in memory by the platform firmware. There are two formats for the IVRS, one that supports fixed DeviceID I/O devices only and a second format that supports both fixed DeviceID devices and ACPI Hardware ID (HID) devices. System software must be capable of handling both formats. The **Revision** field in the IVRS header identifies the format of a given IVRS. **Note:** This revision number does not correspond to a revision level of the IOMMU implementation.

Following the header, the IVRS contains one or more I/O Virtualization Definition Blocks (IVDBs). There are two types of IVDBs:

1. I/O Virtualization Hardware Definition (IVHD) block.

An IVHD provides specific information about each IOMMU in the platform and the devices attached downstream of the IOMMU.

2. I/O Virtualization Memory Definition (IVMD) block.

An IVMD is used to describe any special memory constraints.

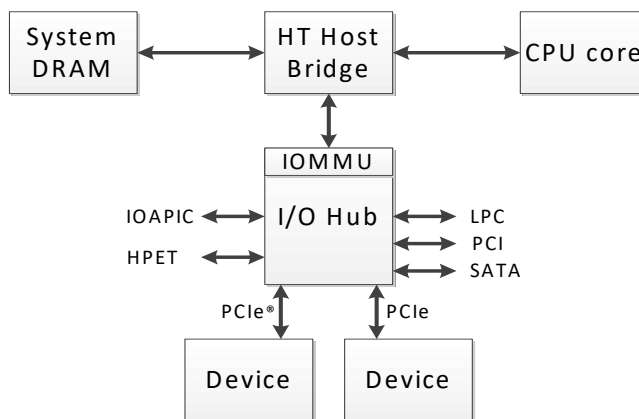

Figure 87: Example Platform Architecture

In the example system shown in [Figure 87](#), there is a single IOMMU and all the I/O devices are attached downstream. Assuming that firmware has pre-assigned I/O device IDs, the pertinent I/O Virtualization information can be described using a single IVHD (type = 10h or 11h) block to define the IOMMU and its attached I/O devices. IVHD *device entries* define the entire range of peripherals (DeviceID 0h through DeviceID FFFFh), probably as a range, (see IVHD device entry types 3 and 4 in [Table 102](#) and IVHD device entry type 71 in [Table 104](#)) and IVHD *special device entries* for the IOAPIC and for the HPET (see IVHD device entry type 72 in [Table 104](#)).

In a system where one or more I/O devices are identified using the ACPI HID format, the IVRS contains a Type 40h IVHD block that may contain both fixed length device entries and variable length device entries to define the entire range of peripherals. Variable length device entries use the ACPI HID device format (See [Table 107](#).) The IOAPIC is required to boot, so it is reported as an IVHD special device entry; the HPET is not required for boot so it can be reported as an IVHD special device entry if it is assigned a BDF by the boot program or as a special device entry if it is not assigned a BDF.

5.1 IOMMU Control Flow

The IOMMU start-up procedure flows through several stages. In general, the IOMMU PCI configuration space is initially configured by the platform firmware and later the primary operational manipulations are done by (privileged) system software. Some settings are programmed into the IOMMU hardware at design time (e.g., virtual address size, physical address size, MSI interrupts). Certain hardware features can be overridden by the platform designer and so are defined in ACPI settings (e.g., the exclusion range, remote IOTLB support), such as when certain features are not included in platform qualification testing or are reserved for use by the platform firmware.

At system reset, the IOMMU is set to a default state. Following system reset, platform firmware is able to program essential platform-specific information into the IOMMU, mostly through the PCI configuration space registers (for example, the MMIO base address). Some additional settings are made by the platform firmware in the MMIO space (for example, tunnel enable) while other settings are made by system software in the MMIO space (for example, the coherent bit). Finally, system software must initialize and manage IOMMU control and operational tables allocated in memory (for example, the device tables). Some of these control and operational settings must be configured according to policies determined by the platform firmware, so they are communicated to system software via the ACPI tables (these include selected interrupt controls and system management controls).

Once configuration is complete, the IOMMU is enabled by system software and begins processing transactions from peripherals. From this point, the IOMMU is under the control of the system software. See “[Starting the IOMMU](#)” on [page 118](#) for more information on starting the IOMMU.

Software Note: *Although this specification allows the placement of IOMMUs outside the root complex, current platform implementations are cautioned against such designs. This architecture does not currently define the ACPI methods or data structures necessary to hot-plug a peripheral controller containing an IOMMU.*

5.2 I/O Virtualization Reporting Structure (IVRS)

The I/O Virtualization Reporting Structure (IVRS) is the ACPI-compatible data structure used to

report the configuration and capabilities of each IOMMU in a platform. There is a single I/O Virtualization Reporting Structure (IVRS) in a system that contains one or more IOMMUs.

Table 82 shows a top-level view of the format of the IVRS. Bytes 0–47 provide header information fields. The **Length** field gives the overall length of the data structure including the length of the header.

Table 82: I/O Virtualization Reporting Structure (IVRS)

Byte Offset	I/O Virtualization Reporting Structure (IVRS)								
00	Signature (“IVRS”)				Length (bytes)				
08	Revision	Check	OEM ID						
16	OEM Table ID								
24	OEM Revision				Creator ID				
32	Creator Revision				IVinfo				
40	Reserved (0000_0000_0000_0000h)								
48	I/O Virtualization Definition Blocks (IVDBs)								
—	Additional IVDBs, as required.								
Offset:	0	1	2	3	4	5	6	7	

Following the 48-byte header, the IVRS contains one or more IVDBs. IVDBs are packed in the IVRS data structure; no padding is allowed. Two types of IVDBs are defined: the IVHD and the IVMD.

Three types of IVHD blocks are defined:

- Types 10h and 11h which support fixed DeviceID device entries only.
- Type 40h which adds support for ACPI HID device entries.

The type 10h IVHD block is defined for backward compatibility and supports the reporting of legacy IOMMU properties to legacy System Software. configuration and capabilities. In order to use the full set of features of the IOMMU, system software must support the decoding of Type 11h and 40h IVHDs. The IVHD Type11h contains all relevant IOMMU feature information. It is recommended for system software to detect IOMMU features from the fields in the IVHD Type11h structure information, superseding information in Type10h block and MMIO registers.

Three types of IVMDs are defined: IVMD types 20h, 21h, and 22h

The inclusion of IVMDs in the IVRS is optional. Each IVMD, if present, provides memory range information related to the IVHD that immediately precedes it. IVMDs may be used for both fixed DeviceID and ACPI HID named devices.

Software Implementation Note: In order to use the full set of features of the IOMMU, system software must support the decoding of Type 11h and 40h IVHDs.

5.2.1 IVRS Header Fields

Table 83 defines the fields of the IVRS headers. Table 84 further describes the **Revision** field and Table 85 describes the sub-fields of the **IVInfo** field.

Table 83: IVRS Fields

IVRS field name	Offset	Size (bytes)	Value	Definition
Signature	00	4	“IVRS”	I/O Virtualization Reporting Structure signature (ASCII)
Length	04	4	Length in bytes	Length in bytes of the entire IVRS, including IVDBs (IVHD and optional IVMD blocks)
Revision	08	1	01h or 02h	IVRS <i>format</i> revision number (see Table 84.)
Check	09	1		Checksum of entire structure must equal zero
OEM ID	10	6		Identifies platform OEM
OEM Table ID	16	8		Specified by OEM
OEM Revision	24	4		Specified by OEM
Creator ID	28	4		Vendor ID of the utility that created the table
Creator Revision	32	4		Revision of the utility that created the table
IVinfo	36	4		I/O virtualization information common to all IOMMU units in a system. See Table 85.
Reserved	40	8	0	Reserved for future use; must be zero
(varies)	48+			I/O Virtualization Definition Blocks (IVDBs)

Notes:

1. IVHDs and IVMDs are subclasses of IVDBs.
2. Revision = 01h IVRS allows only type 10h and 11h IVHDs.
3. Revision = 02h IVRS allows the inclusion of type 10h, 11h, and 40h IVHDs.

Table 84: IVRS Revision Field

Value	IVRS Format	Description
01h	Fixed	This format only supports pre-assigned DeviceIDs. Supports Type 10h and 11h IVHD blocks and all IVMD block types.
02h	Mixed	This format supports both pre-assigned DeviceIDs and ACPI HID device naming. Supports all IVHD and IVMD block types.
03h–FFh	—	<i>reserved.</i>

Software Note: The IVRS Revision field is not related to the revision level of the IOMMU hardware implementation.

Table 85: IVRS IVinfo Field

Field name	Bits	Definition
Reserved	31:23	Must be zero.
HtAtsResv	22	ATS response address translation range reserved. See Capability Offset 10h[HtAtsResv] definition.
VAsize	21:15	Virtual address size. If guest translation is supported, this field defines the width of the Guest Physical Address. See Capability Offset 10h[VAsize] definition.
PAsize	14:8	This field defines the width of the System Physical Address. See Capability Offset 10h[PAsize] definition.
GVAsize	7:5	Guest virtual address width. See Capability Offset 10h[GVAsize] definition.
Reserved	4:2	Must be zero.
DMA remap support	1	Presence of this flag indicates to the OS/HV that the IOMMU is used for Pre-Boot DMA protection and device accessed memory should be remapped after the OS has loaded.
EFRSup	0	Extended Feature Support. See Capability Offset 00h[EFRSup] definition.

Notes:

1. If DMA remap support flag is set, the platform must declare all ACPI device instances via F0h format IVHD device entry type declaration and with a string type UID (see [Table 107](#)). Other IVHD ACPI device entry type declarations are not permitted. Other IVHD device entry type and range declarations (for example, referring to PCI devices located in other PCI segments) are still permitted when this flag is set.

5.2.2 I/O Virtualization Definition Blocks

The following section describes the I/O Virtualization Hardware Definition (IVHD) block and “[I/O Virtualization Memory Definition \(IVMD\) Block](#)” on page 296 describes the I/O Virtualization Memory Definition (IVMD) block. IVMD blocks are optional. If a IVMD is included, it pertains to the IVHD block that immediately precedes it.

5.2.2.1 I/O Virtualization Hardware Definition (IVHD) Block

Each IOMMU in the system is described by one IVHD block. The IVHD block is shown [Table 86](#) below. An IOMMU and the peripherals it serves must be on the same PCI Segment defined in the IVHD block. The IVHD block contains at least one IVHD device entry. Each entry describes one or a range of I/O devices that the IOMMU virtualizes.

Table 86: I/O Virtualization Hardware Definition (IVHD) Block Generic Format

Byte offset	I/O Virtualization Hardware Definition (IVHD) block								
0	Type	Flags	Length		IOMMU DeviceID		Capability Offset		
8	IOMMU Base address								
16	PCI Segment Group		IOMMU info		IOMMU feature information				
Types 11h, 40h only	24	IOMMU EFR Image							
	32	reserved							
	24 or 40	IVHD device entries ...							
	—	Additional device entries as required.							
Offset:	0	1	2	3	4	5	6	7	

The **IOMMU DeviceID** in the IVHD header identifies the IOMMU defined by the IVHD block. The **Capability Offset** is required in case the function implements multiple IOMMU capabilities.

All peripherals that can generate transactions processed by an IOMMU must be defined in the IVHD.

There are two classes of IVHD blocks: 1) The fixed-length IVHD, which only allows the inclusion of device entries that are identified using pre-assigned DeviceIDs, and 2) the variable-length IVHD, which allows the inclusion of devices that are identified using ACPI HID device names.

Device entries are packed into the IVHD following the 24 or 40 byte header (shown in Table 86 above). If a mixed format IVRS includes both fixed length and variable length device entries, the fixed length device entries must appear first in the data structure, followed by the variable length device entries.

These two classes of IVHDs are described in the following sections.

Fixed-Length IVHD Blocks

The IVHD device entries, which follow the 24 or 40 byte header, describe the I/O topology (start and end of a range, or single entries) of I/O devices and slots served by an IOMMU. All possible Device IDs must be defined, whether the DeviceID is actually populated or not. Device entries are used to report ranges when hot-plug and SR-IOV devices are possible. Each DeviceID is described by one IVHD device entry which may be a select or select-alias record or is part of a range or an alias range. If a given DeviceID exists but can generate neither DMA nor interrupts (ever), it need not be listed in the IVHD block. A DeviceID used as an alias must be included in the device list (either “select” or “range”). The simplest IVRS contains one DeviceID range for each IOMMU; a system with one IOMMU may report as little as a single range covering all DeviceIDs (0000h–FFFFh).

Implementation Note: all DeviceID values served by an IOMMU must be reported in an IVHD block including DeviceIDs not yet populated (including, but not limited to, virtual functions and empty hot-

plug slots).

There must be at least one IVHD device entry to describe at least one I/O device or slot governed by the IOMMU; an IOMMU may govern multiple ranges and singletons of I/O devices. A IVHD device entry can provide information about a single device, a sub-range of devices, or all the devices virtualized by that IOMMU. When a IVHD device entry defines the start of a range, a second device entry, immediately following the first, defines the end of the range. The range definition is inclusive of the first and last device specified. IVHD device entries specify the settings for specific IOMMU DTE fields for that device or range of devices in the IOMMU Device Table.

See “[IVHD Device Entries](#)” on page 291 for more information on device entries.

For peripherals that use source identification other than their own DeviceID, alias entries must be used. An IOMMU and the peripherals it serves must be on the same PCI Segment Group defined in the IVHD block. At this time, only PCI Segment Group 0 is supported. The IVHD length field specifies the number of bytes in the IVHD block, starting from the Type field.

There are two types of fixed-length IVHDs defined: Type 10h and Type 11h. [Table 87](#), [Table 88](#), [Table 89](#), [Table 90](#), [Table 91](#), and [Figure 88](#) define the Type 10h IVHD and [Table 92](#), [Table 93](#), [Table 94](#), and [Table 95](#) define the Type 11h IVHD.

Type 10h IVHD

Table 87: I/O Virtualization Hardware Definition (IVHD) Type 10h

IVRS Byte off- set	I/O Virtualization Hardware Definition (IVHD) block								Relative offset
48	Type (10h)	Flags	Length		DeviceID	Capability offset		+0	
56	IOMMU base address								+8
64	PCI Segment Group		IOMMU info		IOMMU Feature Reporting			+16	
72+	IVHD device entries				...			+24	
Offset:	0	1	2	3	4	5	6	7	-

Table 88: IVHD Type 10h Field Definitions

Field Name	Offset	Size (bytes)	Value	Definition
Type	0	1	10h	I/O virtualization hardware definition block type 10h
Flags	1	1		Settings for selected IOMMU control fields (see Table 89)
Length	2	2		Size of IVHD block in bytes, starting from Type field and including IVHD device entries.
DeviceID	4	2		DeviceID of IOMMU
Capability offset	6	2		Offset in Capability space for control fields of IOMMU
IOMMU base address	8	8		Base address of IOMMU control registers in MMIO space
PCI Segment Group	16	2	0000h	PCI Segment Group number
IOMMU info	18	2		Interrupt numbers and UnitID (see Table 90)
IOMMU Fea- ture Report- ing	20	4		IOMMU Feature Reporting (see Table 91). If IVinfo[EFR-Sup] = 0, this field is Reserved.
IVHD device entries	24	<i>n</i>		Fixed length (4 or 8 byte) IVHD device entries (see Section [IVHD Device Entries])

Table 89: IVHD Flags Field

Flag Name	Bit	Definition
PPRSup	7	Defines peripheral page service support to system software (see MMIO Offset 0030h [PPRSup]).
PreFSup	6	Defines PREFETCH_IOMMU_PAGES support to system software (see MMIO Offset 0030h [PreFSup]).
Coherent	5	Recommended setting for Coherent control bit to system software (see MMIO Offset 0018h [Coherent]). The recommended value is 1b.
IotlbSup	4	Defines remote IOTLB support to system software (see Capability Offset 00h [IotlbSup]).
Isoc	3	Recommended setting for Isoc control bit to system software (see MMIO Offset 0018h [Isoc]).
ResPassPW	2	Recommended setting for ResPassPW to system software (see MMIO Offset 0018h [ResPassPW]).
PassPW	1	Recommended setting for PassPW to system software (see MMIO Offset 0018h [PassPW]).
HtTunEn	0	Recommended setting for HtTunEn to system software (see MMIO Offset 0018h [HtTunEn]).

Table 90: IVHD IOMMU Info Field

Field Name	Bits	Definition
Reserved	15:13	Reserved.
UnitID	12:8	Unit ID number (see Capability Offset 0Ch [UnitID])
Reserved	7:5	Reserved.
MSInum	4:0	MSI message number for event log (see Capability Offset 10h [MsiNum])

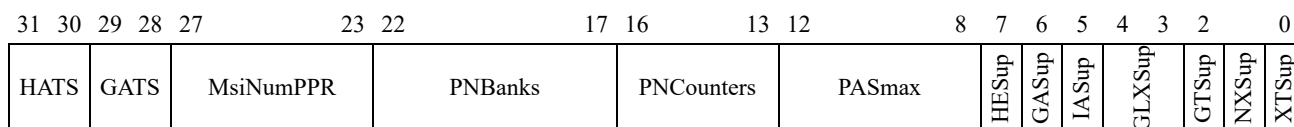
**Figure 88: IVHD Type 10h IOMMU Feature Reporting Field Format****Table 91: IVHD IOMMU Feature Reporting Field**

Field Name	Bits	Definition
HATS	31:30	Host address translation size (see MMIO Offset 0030h [HATS]).
GATS	29:28	Guest address translation size (see MMIO Offset 0030h [GATS]). This value must be zero when MMIO Offset 0030h [GTSup]=0.

Table 91: IVHD IOMMU Feature Reporting Field (Continued)

Field Name	Bits	Definition
MsiNumPPR	27:23	MsiNumPPR for peripheral page requests (see Capability Offset 10h [MsiNumPPR]); must be 0_0000b when MMIO Offset 0030h [PPRSup] = 0.
PNBanks	22:17	Number of performance counter banks (see MMIO Offset 4000h [NCounterBanks]).
PNCounters	16:13	Number of performance counters per counter bank (see MMIO Offset 4000h [NCounter]).
PASmax	12:8	Parameter that indicates the maximum PASID value supported by the IOMMU (see MMIO Offset 0030h [PASmax]). Must be ignored if MMIO Offset 0030h [PPRSup] = 0.
HESup	7	Hardware Error Registers supported (see Section 2.5.16.2 [I/O Hardware Event Reporting Registers]).
GASup	6	Guest virtual APIC supported (see MMIO Offset 0030h [GASup]).
IASup	5	INVALIDATE_IOMMU_ALL supported (see MMIO Offset 0030h [IASup]).
GLXSup	4:3	Number of guest CR3 tables supported (see MMIO Offset 0030h [GLXSup]).
GTSup	2	Guest translation supported (see MMIO Offset 0030h [GTSup]).
NXSup	1	NX supported for I/O (see MMIO Offset 0030h [NXSup]).
XTSup	0	x2APIC supported for peripherals (see MMIO Offset 0030h [XTSup]).

Software Note: Using the information contained in a Type 10h IVHD an indication of support for the performance counter feature can be derived from the IOMMU Feature Reporting Fields PNBanks and PNCounters. When PNBanks and PNCounters both equal 0, then the performance counter feature is not supported. (see [MMIO Offset 0030h](#)[PCSup]). The Type 11h IVHD (see the next section) supplies a direct indication of support for the performance counter feature by providing an image of the IOMMU Extended Feature Register [[MMIO Offset 0030h](#)] hardware register.

Type 11h IVHD

If IVinfo[EFRSup] = 0, IVHD Type 11h is Reserved.

Table 92: I/O Virtualization Hardware Definition (IVHD) Type 11h

IVRS Byte offset	I/O Virtualization Hardware Definition (IVHD) block							Relative offset	
48	Type (11h)	Flags	Length		DeviceID	Capability offset		+0	
56	IOMMU base address							+8	
64	PCI Segment Group		IOMMU info		IOMMU Attributes			+16	
72	EFR Register Image							+24	
80	EFR Register Image 2							+32	
88+	IVHD device entries							+40	
Offset:	0	1	2	3	4	5	6	7	-

Table 93: IVHD Type 11h Field Definitions

Field Name	Offset	Size (bytes)	Value	Definition
Type	0	1	11h	I/O virtualization hardware definition block type 11h
Flags	1	1		Recommended settings for selected IOMMU control fields See Table 94
Length	2	2	(bytes)	Size of IVHD block in bytes, starting from Type field and including IVHD device entries.
DeviceID	4	2		DeviceID of IOMMU
Capability offset	6	2		Offset in Capability space for control fields of IOMMU
IOMMU base address	8	8		Base address of IOMMU control registers in MMIO space
PCI Segment Group	16	2	0000h	PCI Segment Group number
IOMMU info	18	2		Interrupt numbers and UnitID (Table 90)
IOMMU Attributes	20	4		IOMMU information not reported in the MMIO Offset 30h Extended Feature Register (Table 95)
EFR Register Image	24	8		Exact copy of the IOMMU Extended Feature Register [MMIO Offset 0030h]

Table 93: IVHD Type 11h Field Definitions (Continued)

Field Name	Offset	Size (bytes)	Value	Definition
EFR Register Image 2	32	8		Exact copy of the IOMMU Extended Feature 2 Register [MMIO Offset 01A0h]
IVHD device entries	40	<i>n</i>		Fixed length (4 or 8 byte) IVHD device entries. See Section [IVHD Device Entries]

Table 94: IVHD Flags Field

Flag Name	Bit	Definition
—	7	Reserved
—	6	Reserved
Coherent	5	Recommended setting for Coherent control bit to system software (see MMIO Offset 0018h[Coherent]). The recommended value is 1b.
IotlbSup	4	Defines remote IOTLB support to system software (see Capability Offset 00h[IotlbSup]).
Isoc	3	Recommended setting for Isoc control bit to system software (see MMIO Offset 0018h[Isoc]).
ResPassPW	2	Recommended setting for ResPassPW to system software (see MMIO Offset 0018h[ResPassPW]).
PassPW	1	Recommended setting for PassPW to system software (see MMIO Offset 0018h[PassPW]).
HtTunEn	0	Recommended setting for HtTunEn to system software (see MMIO Offset 0018h[HtTunEn]).

Table 95: IVHD Type 11h IOMMU Attributes

Field Name	Bits	Definition
—	31:28	Reserved.
MsiNumPPR	27:23	MsiNumPPR for peripheral page requests (see Capability Offset 10h[MsiNumPPR])
PNBanks	22:17	Number of performance counter banks (see MMIO Offset 4000h[NCounterBanks]).
PNCounters	16:13	Number of performance counters per counter bank (see MMIO Offset 4000h[NCounter]).
—	12:0	Reserved.

Mixed Format IVHD Block

Mixed format IVHD blocks can contain fixed-length assigned DeviceID device entries and variable length ACPI HID named device entries. The mixed format IVHD block is identified as Type = 40h. If IVinfo[EFRSup] = 0, IVHD Type 40h is Reserved.

Table 96: I/O Virtualization Hardware Definition (IVHD) Type 40h Fields

IVRS Byte off- set	I/O Virtualization Hardware Definition (IVHD) block.								Relative offset
48	Type (40h)	Flags	Length		DeviceID	Capability offset			+0
56	IOMMU base address								+8
64	PCI Segment Group		IOMMU info		IOMMU Attributes				+16
72	EFR Register Image								+24
80	EFR Register Image 2								+32
88	IVHD device entries ...								+40
Offset:	0	1	2	3	4	5	6	7	-

Table 97: IVHD Type 40h Field Definitions

Field Name	Offset	Size (bytes)	Value	Definition
Type	0	1	40h	I/O virtualization hardware definition block type 40h
Flags	1	1		Recommended settings for selected IOMMU control fields See Table 94
Length	2	2	(bytes)	Size of IVHD block in bytes, starting from Type field and including IVHD device entries.
DeviceID	4	2		DeviceID of IOMMU
Capability offset	6	2		Offset in Capability space for control fields of IOMMU
IOMMU base address	8	8		Base address of IOMMU control registers in MMIO space
PCI Segment Group	16	2	0000h	PCI Segment Group number
IOMMU info	18	2		Interrupt numbers and UnitID (Table 90)
IOMMU Attributes	20	4		IOMMU information not reported in the MMIO Offset 30h Extended Feature Register (Table 95)

Table 97: IVHD Type 40h Field Definitions(Continued)

Field Name	Offset	Size (bytes)	Value	Definition
EFR Register Image	24	8		Exact copy of the IOMMU Extended Feature Register [MMIO Offset 0030h]
EFR Register Image 2	32	8		Exact copy of the IOMMU Extended Feature 2 Register [MMIO Offset 01A0h]
IVHD device entries	40	<i>n</i>		IVHD device entries. All device entry types are allowed. (See Section [IVHD Device Entries])

Table 98: IVHD Type 40 Flags Field

Flag Name	Bit	Definition
—	7	reserved
—	6	reserved
Coherent	5	Recommended setting for Coherent control bit to system software (see MMIO Offset 0018h[Coherent]). The recommended value is 1b.
IotlbSup	4	Defines remote IOTLB support to system software (see Capability Offset 00h[IotlbSup]).
Isoc	3	Recommended setting for Isoc control bit to system software (see MMIO Offset 0018h[Isoc]).
ResPassPW	2	Recommended setting for ResPassPW to system software (see MMIO Offset 0018h[ResPassPW]).
PassPW	1	Recommended setting for PassPW to system software (see MMIO Offset 0018h[PassPW]).
HtTunEn	0	Recommended setting for HtTunEn to system software (see MMIO Offset 0018h[HtTunEn]).

Table 99: IVHD Type 40h IOMMU Attributes

Field Name	Bits	Definition
—	31:28	Reserved.
MsiNumPPR	27:23	MsiNumPPR for peripheral page requests (see Capability Offset 10h[Msi-NumPPR])
PNBanks	22:17	Number of performance counter banks (see MMIO Offset 4000h[NCOUNTERBANKS]).
PNCOUNTERS	16:13	Number of performance counters per counter bank (see MMIO Offset 4000h[NCOUNTER]).
—	12:0	Reserved.

IVHD Device Entries

The device entry types 00h–7Fh are used for fixed length device entries and device entry types 80h–FFh are reserved for variable length device entries. See [Table 100](#).

Table 100: IVHD Device Entry Length Based on Type

IVHD device entry type range (decimal)	IVHD device entry type range (hexadecimal)	Uppermost 2-bits	IVHD device entry length (bytes)
0–63	00h–3Fh	00b	4 bytes
64–127	40h–7Fh	01b	8 bytes
128–255	80h–FFh	1xb	variable length

Fixed-length IVHD device entries can be used to describe one or more PCI bus-device-function (BDF) or HyperTransport™ bus-unit addresses. When IVHD entries describe a range of addresses, the DeviceID address is treated as if it were 16-bit integer so that, for example, DeviceID 0100h (Bus 1, Device 0, Function 0) follows DeviceID 00FFh (Bus 0, Device 31, Function 7), and DeviceID 0518h (Bus 5, Device 3, Function 0) follows DeviceID 0517h (Bus 5, Device 2, Function 7).

Assigned DeviceID Device Entries

Device entries for devices with assigned device IDs are fixed in length. Two formats are defined: 4-byte and 8-byte.

IVHD 4-byte device entries

The 4-byte IVHD device entry is structured to contain a single DeviceID with related DTE settings. A 4-byte IVHD device entry must be aligned to a 4-byte boundary.

Table 101: IVHD Device Entry Fields (4-byte)

Byte offset:	+0	+1	+2	+3
Byte contents:	Device entry type	DevID		DTE setting

Table 102: IVHD Device Entry Type Codes (4-byte)

Byte 0: IVHD device entry type (4-byte)	Bytes 1 & 2: DeviceID	Byte 3: DTE Setting	Entry Definition
0	0000h	00h	reserved.
1	(ignored)	DTE setting	All. DTE setting applies to all DeviceIDs controlled by the IOMMU.
2	DevID	DTE setting	Select. DTE setting applies to the device specified in DevID field.

Table 102: IVHD Device Entry Type Codes (4-byte) (Continued)

Byte 0: IVHD device entry type (4-byte)	Bytes 1 & 2: DeviceID	Byte 3: DTE Setting	Entry Definition
3	DevID	DTE setting	Start of range. DTE setting applies to all devices from start of range specified by the DevID field of this entry to the DeviceID specified by the DevID field of the subsequent type 4 device entry. The range is inclusive.
4	DevID	00h	End of range. The DTE setting from the previous type 3 device entry applies to all devices including the DeviceID specified by the DevID field of this entry.
5–63 (05h–3Fh)	—	—	Reserved.

Table 103: IVHD Device Table Entry DTE Setting

Bits	Field	Definition
7	Lint1Pass	Identifies a device able to assert LINT1 interrupts
6	Lint0Pass	Identifies a device able to assert LINT0 interrupts
5:4	SysMgt[1:0]	Identifies a device able to assert System Management messages (e.g. VID/FID)
3	Reserved	Reserved; must be zero.
2	NMIPass	Identifies a device able to assert NMI interrupts
1	EIntPass	Identifies a device able to assert ExtInt interrupts
0	INITPass	Identifies a device able to assert INIT interrupts

The fields contained in [Table 103](#) are defined in [Table 7](#) on page 64. Extended DTE settings are defined in [Table 105](#).

IVHD 8-byte device entries

The 8-byte IVHD device entry is used to convey more information than is possible with a 4-byte device entry. [Table 104](#) lists the defined 8-byte device entries.

Table 104: IVHD Device Entry Type Codes (8-byte)

Byte 0: Device entry type	Bytes 1 & 2	Byte 3 (Table 103)	Byte 4	Bytes 5 & 6	Byte 7	Entry Definition
64–65 (40h–41h)	0000h	00h	00h	0000h	00h	Reserved.
66 (42h)	DevIDa: Actual peripheral DeviceID	DTE Set- ting	00h	DevIDb: DeviceID used as source by peripheral	00h	Alias select. DTE setting applies to device specified by DevIDa; device uses DevIDb as source identification infor- mation.
67 (43h)	DevIDa: Actual peripheral DeviceID	DTE Set- ting	00h	DevIDb: DeviceID used as source by peripheral	00h	Alias start of range. DTE set- ting applies to all peripherals from start of range; all periph- erals in range use DevIDb as source identification informa- tion. Range is terminated with a type 4 device entry (end of range). The range is inclusive.
68–69 (44h–45h)	0000h	00h	00h	0000h	00h	Reserved
70 (46h)	DevID	DTE set- ting	Extended DTE setting (see Table 105)			Extended select. DTE setting and extended DTE setting apply to device specified by DevID
71 (47h)	DevID	DTE set- ting	Extended DTE setting (see Table 105)			Extended start of range. DTE setting and extended DTE set- ting apply to all devices start- ing from the device specified by the DevID field. Range is terminated with an IVHD entry type 4 (end of range); The range is inclusive.
72 (48h)	0000h	DTE set- ting	Handle	DevIDb: DeviceID used as source by peripheral	Variety Table 106	Special Device. Handle con- tains the I/O APIC ID or the HPET Number. Variety encodes IOAPIC or HPET.
73–127 (49h–7Fh)	—	—	—			Reserved

Special devices (specified by device entry type 72) are not normally identified through enumeration.

An Alias device type entry is used for each peripheral that does not use its own DeviceID information in bus transactions. For example, peripherals downstream of a bridge device that use the DeviceID of the bridge must have a corresponding Alias Select or Alias Start of Range entry to inform system software which IOMMU Device Table entry will be used for translation information.

When an Alias device type entry is used, the IVHD block cannot contain a device type entry of type 1 (ALL), 2 (Select), or 3 (Start of Range) that includes the same peripherals. When the (type 67, type 4) IVHD type pair is used to define a range, all the included peripherals use the same DeviceID (b) as a DeviceID and thus the same IOMMU Device Table entry. An extended entry of type 70 or type 71 is used when the extended attributes in [Table 105](#) must be expressed.

Table 105: IVHD Device Entry Extended DTE Setting Field

Bit	Field	Definition
31	AtsDisabled	Device must be prevented from issuing address translation requests. 1b = block ATS requests; 0b = allow ATS.
30:0	—	Reserved; must be zero.

A peripheral not identified in the normal enumeration process requires a Special Device table entry of type 72. The variety of the peripheral and the associated tag are provided as show in [Table 106](#).

Table 106: IVHD Special Device Entry Variety Field

Variety value	Special device	Handle definition
00h	—	Reserved.
01h	IOAPIC	The I/O APIC ID from the APCI MADT.
02h	HPET	The HPET Number from the HPET table.
03h–FFh	—	Reserved.

ACPI Hardware ID Device Entries

The Advanced Configuration and Power Interface Specification (ACPI) (see [“Related Documents” on page 28](#)) defines a means by which the platform firmware can identify installed I/O devices to the operating system. The operating system uses this information to discover and bind a device driver to the hardware device.

The ACPI specification defines the format of both the Hardware ID (HID) and the Compatible ID (CID). Firmware uses this information to build ACPI HID named device entries in the IVHD. [Table 107](#) defines the format of the device entry for ACPI HID named devices. ACPI device declarations in IVHD should not alias device resources that are already enumerated to software by other means (for example, through the PCI configuration space and no aliasing).

Table 107: Device Entry Type F0h Fields

Field Name	Offset	Size (bytes)	Value	Definition
Type	0	1	F0h (240d)	Identifies entry as a variable-length ACPI HID device entry.
DeviceID	1	2		DeviceID used as source by peripheral.
DTE Settings	3	1		See Table 103 .
Hardware ID (HID)	4	8		ACPI Hardware ID
Compatible ID (CID)	12	8		ACPI Compatible ID
Unique ID Format	20	1		0 = UID not present 1 = UID is an integer 2 = UID is a character string
Unique ID Length	21	1		Length of following field ("UID", offset 22) in bytes. 0 = UID not present
Unique ID (UID)	22	variable		ACPI UID (See Note 5.)

Notes:

1. For the operating system to properly identify a device that is not bus-enumerable, a HID is required while a CID is optional. If both are provided, the operating system attempts to bind the device to a driver using the HID. If no driver for the specific device is discovered, the operating system may attempt to bind the device to a generic driver using the CID, if available.
2. The HID can be a 32-bit integer or a character string. If an integer, the lower 4 bytes of the field contain the integer and the upper 4 bytes are padded with 0. If the HID is a string, it must be a valid 8-byte ACPI ID or a valid 7-byte PNP ID with the upper byte padded with 0.
3. The CID is an optional field. If present, CID must be a single Compatible Device ID following the same format as the HID field. If the CID is not provided, this field should be set to zero.
4. The UID is required if there are multiple instances of the device in the ACPI namespace. If the UID field is not present, the length of the ACPI HID device entry is 22 bytes.
5. If defined as a character string, the ACPI UID marks the instances of DMA-capable devices with the defined DeviceID (e.g. IOMMU visible Routing ID). It should match the ACPI device namespace strings with unit number, but without a trailing \0 character (as the UID length specifies the size of the string already).
For example, “_SB.FUR0” or “_SB.FUR1” represent string definitions for separate ACPI device instances visible to software, but that use the same device hardware and therefore the same DeviceID visible to IOMMU; these two instances would require two F0h entries, each using the same DeviceID in offset 1.

5.2.2.2 I/O Virtualization Memory Definition (IVMD) Block

Platform firmware may have memory usage requirements to communicate to system software based on its needs or on hardware characteristics. Platform firmware can inform system software of memory usage restrictions or requirements by using I/O Virtualization Memory Definition (IVMD) blocks.

Assigned DeviceID IVMD Block

For the assigned DeviceID IVMD, each IVMD may be per-device, specifying the DeviceID to which the block applies, or the IVMD entry may apply to all devices and the DeviceID is ignored. IVMD blocks may reference the DeviceIDs supplied in IVHD entries for alias ranges, special devices, and ACPI HID named devices. System software is expected to use the information in the IVMD blocks when it programs the IOMMU.

Table 108: IVMD Types 20h–22h Format

Byte off-set	I/O Virtualization Memory Definition (IVMD) block								Relative offset
0	Type	Flags	Length		DeviceID	Auxiliary data			+0
8-9	PCI segment ID								+8
10-15	Reserved (0000_0000_0000_0000h)								+10
16	IVMD start address								+16
24	IVMD memory block length								+24
Offset:	0	1	2	3	4	5	6	7	-

The IVMD block fields are defined in [Table 109](#). Note that a memory definition block may apply to a particular peripheral device, multiple peripheral devices, or all peripheral devices. When a memory block is defined for multiple peripheral devices, but not all, the IVMD definition is repeated for each discontinuous peripheral device or range to which the memory definition applies. If IR = 0b and IW = 0b in the IVMD flags field, then the memory range is not to be mapped into the peripheral device address space and the unity flag field must be 0b. To prevent a memory range from ever being mapped into any peripheral device address space, use IR = 0b and IW = 0b in the IVMD flags field and IVMD type = 20h (all devices).

Table 109: IVMD Types 20h–22h Fields

Field Name	Offset	Size (bytes)	Value	Definition
Type	0	1	20h=all peripherals; 21h=specified peripheral; 22h=peripheral range	I/O virtualization memory definition block
Flags	1	1	(see Table 110)	Flags for memory block
Length	2	2	32	Length of IVMD block in bytes

Table 109: IVMD Types 20h–22h Fields (Continued)

Field Name	Offset	Size (bytes)	Value	Definition
DeviceID	4	2		Type 20h: field reserved; Type 21h: DeviceID; Type 22h: starting DeviceID of range
Auxiliary data	6	2		Types 20h, 21h: field reserved; Type 22h: ending DeviceID of range (inclusive)
Reserved	8	8	0	Reserved
PCI Segment Group	8	2		Type 20h: field reserved; Type 21h, 22h: PCI Segment Group number for corresponding DeviceID
Start address	16	8		System Physical Address of start of memory block
Memory block length	24	8	Length in bytes	Length of memory block; system software may round up to 4-Kbyte boundary

Table 110: IVMD Flags Definitions

Flags Field Name	Bits	Definition
—	7:4	Reserved; must be zero.
ExclusionRange	3	Exclusion range. 1b = included in exclusion range, 0b=not in exclusion range. <i>Note: IR, IW, and Unity are ignored when ExclusionRange = 1b.</i>
IW	2	Write permission. 1b=writeable, 0b=not writeable.
IR	1	Read permission. 1b=readable, 0b=not readable.
Unity	0	Unit address mapping. 1b=virtual addresses must be the same value as physical addresses. 0b=any virtual address translation may be used.

The IVMD flag field applies to individual devices when IVMD type = 21h, to all devices in a system when IVMD type = 20h, and to all devices in the DeviceID range when IVMD type = 22h.

5.3 I/O Virtualization Device Tree

The I/O Virtualization Device Tree (IVDT) is an alternative to the IVRS data structure described above. I/O device information should be supplied by platform firmware in the device tree format whenever ACPI-compatibility is not a requirement or not desirable (for instance, on an x86 platform built for Linux).

5.3.1 I/O Virtualization Device Tree Data Structure

The following psuedo code structure defines the I/O Virtualization Device Tree (IVDT):

```
I/O Virtualization Device Tree Data Structure
/* NOTE:
 * - substitute # with value
 * - substitute X with [0 to (n-1)]
 */
/* This entry is per IOMMU */
iommuX : iommu@0x##### {
    compatible = "amd,iommu-v2", "amd,iommu-v3";
    ivrs,revision = <0x2>;
    ivrs,ivinfo = <#>;

    ivhd {
        compatible = "amd,ivrs-ivhd";
        type = <#>;
        flags = <#>;
        device_entries = <#>;
        iommu_dev_id = <#>;
        capabilities_offset = <#>;
        iommu_base_address = <# #>;
        pci_segment_group = <#>;
        iommu_info = <#>;
        iommu_attributes = <#>;
        iommu_ext_features = <# #>;

        device_entryX {
            compatible = "amd,ivrs-device-entry";
            /* entry can be 4, 8 or 22+ bytes */
            entry = [ # # # # ... ];
        };

        /* .. next "device_entry" node (if any) */
    };
    /* Optional */
    ivmdX {
        compatible = "amd,ivrs-ivmd";
        type = <#>;
        flags = <#>;
        devid_start = <#>;
        devid_end = <#>;
        start_address = <# #>;
        block_length = <# #>;
    };
    /* .. next "ivmd" node (if any) */
};
/* .. next "iommu" node (if any) */
```

Index to Registers

Capability Offset 00h	IOMMU Capability Header	196
Capability Offset 04h	IOMMU Base Address Low Register	197
Capability Offset 08h	IOMMU Base Address High Register	198
Capability Offset 0Ch	IOMMU Range Register	198
Capability Offset 10h	IOMMU Miscellaneous Information Register 0	199
Capability Offset 14h	IOMMU Miscellaneous Information Register 1	201
Vendor Specific Capability Offset 00h	IOMMU Vendor Specific Capability Header	201
Vendor Specific Capability Offset 04h	IOMMU Vendor Specific Capability Info.	202
Vendor Specific Capability Offset 08h	IOMMU Virtual Function Base Address Low Register	202
Vendor Specific Capability Offset 0Ch	IOMMU Virtual Function Base Address High Register	202
Vendor Specific Capability Offset 10h	IOMMU Virtual Function Control Base Address Low Register	203
Vendor Specific Capability Offset 14h	IOMMU Virtual Function Control Base Address High Register	203
MMIO Offset 0000h	Device Table Base Address Register	204
MMIO Offset 0008h	Command Buffer Base Address Register	205
MMIO Offset 0010h	Event Log Base Address Register	206
MMIO Offset 0018h	IOMMU Control Register	207
MMIO Offset 0020h	IOMMU Exclusion Base Register / Completion Store Base Register	213
MMIO Offset 0028h	IOMMU Exclusion Range Limit Register / Completion Store Limit Register	214
MMIO Offset 0030h	IOMMU Extended Feature Register	215
MMIO Offset 0038h	PPR Log Base Address Register	219
MMIO Offset 0040h	IOMMU Hardware Event Upper Register	220
MMIO Offset 0048h	IOMMU Hardware Event Lower Register	220
MMIO Offset 0050h	IOMMU Hardware Event Status Register	221
MMIO Offset 00[60-D8]h	IOMMU SMI Filter Register	221
MMIO Offset 00E0h	Guest Virtual APIC Log Base Address Register	222
MMIO Offset 00E8h	Guest Virtual APIC Log Tail Address Register	223
MMIO Offset 00F0h	PPR Log B Base Address Register	225
MMIO Offset 00F8h	Event Log B Base Address Register	226
MMIO Offset 01[00-30]h	Device Table Segment <i>n</i> Base Address Register	227
MMIO Offset 0138h	Device-Specific Feature Extension (DSFX) Register	228
MMIO Offset 0140h	Device-Specific Control Extension (DSCX) Register	229
MMIO Offset 0148h	Device-Specific Status Extension (DSSX) Register	229
MMIO Offset 0150h	MSI Vector Register 0	230
MMIO Offset 0154h	MSI Vector Register 1	230

MMIO Offset 0158h	MSI Capability Header Register	230
MMIO Offset 015Ch	MSI Address Low Register	231
MMIO Offset 0160h	MSI Address High Register	231
MMIO Offset 0164h	MSI Data Register	232
MMIO Offset 0168h	MSI Mapping Capability Header Register	232
MMIO Offset 016Ch	IOMMU Performance Optimization Control Register	233
MMIO Offset 0x170h XT	IOMMU General Interrupt Control Register	234
MMIO Offset 0x178h XT	IOMMU PPR Interrupt Control Register	235
MMIO Offset 0x180h XT	IOMMU GA Log Interrupt Control Register	236
MMIO Offset 0x190h	vIOMMU Status Register	237
MMIO Offset 02[00,18,30,48]h	MARC Aperture [0–3] Base Register	238
MMIO Offset 02[08,20,38,50]h	MARC Aperture [0–3] Relocation Register	239
MMIO Offset 02[10,28,40,58]h	MARC Aperture [0–3] Length Register	239
MMIO Offset 01A0h	IOMMU Extended Feature 2 Register	240
MMIO Offset 1FF8h	IOMMU Reserved Register	240
MMIO Offset 2000h	Command Buffer Head Pointer Register	241
MMIO Offset 2008h	Command Buffer Tail Pointer Register	241
MMIO Offset 2010h	Event Log Head Pointer Register	242
MMIO Offset 2018h	Event Log Tail Pointer Register	243
MMIO Offset 2020h	IOMMU Status Register	243
MMIO Offset 2030h	IOMMU PPR Log Head Pointer Register	246
MMIO Offset 2038h	IOMMU PPR Log Tail Pointer Register	246
MMIO Offset 2040h	Guest Virtual APIC Log Head Pointer Register	247
MMIO Offset 2048h	Guest Virtual APIC Log Tail Pointer Register	247
MMIO Offset 2050h	PPR Log B Head Pointer Register	248
MMIO Offset 2058h	PPR Log B Tail Pointer Register	248
MMIO Offset 2070h	Event Log B Head Pointer Register	249
MMIO Offset 2078h	Event Log B Tail Pointer Register	249
MMIO Offset 2080h	PPR Log Auto Response Register	250
MMIO Offset 2088h	PPR Log Overflow Early Indicator Register	251
MMIO Offset 2090h	PPR Log B Overflow Early Indicator Register	251
MMIO Offset 4000h	IOMMU Counter Configuration Register	252
MMIO Offset 4008h	IOMMU Counter PASID Bank-Lock Register	253
MMIO Offset 4010h	IOMMU Counter Domain Bank-Lock Register	254
MMIO Offset 4018h	IOMMU Counter DeviceID Bank-Lock Register	254
MMIO Offset [40-7F][0-F]00h	IOMMU Counter Register	256
MMIO Offset [40-7F][0-F]08h	IOMMU Counter Source Register	257
MMIO Offset [40-7F][0-F]10h	IOMMU PASID Match Register	259
MMIO Offset [40-7F][0-F]18h	IOMMU Domain Match Register	260
MMIO Offset [40-7F][0-F]20h	IOMMU DeviceID Match Register	261
MMIO Offset [40-7F][0-F]28h	IOMMU Counter Report Register	262
VFCntIOMMU Offset {16'b[GuestID], 6'b00_0000}	Guest Device Map Control Register	263

VFCntI MMIO Offset {16'b[GuestID], 6'b00_1000}	
	Guest Domain Map Control Register 263
VFCntI MMIO Offset {16'b[GuestID], 6'b01_1000}	
	Guest Event LogB Buffer Control Register. 264
VFCntI MMIO Offset {16'b[GuestID], 6'b10_0000}	
	Guest Command Control Register. 265
VFCntI MMIO Offset {16'b[GuestID], 6'b10_1000}	
	Guest Event Control Register 266
VFCntI MMIO Offset {16'b[GuestID], 6'b11_0000}	
	Guest PPR Control Register 267
VFCntI MMIO Offset {16'b[GuestID], 6'b11_1000}	
	Guest PPRB Control Register 268
VFMMIO Offset {16'b[GuestID], 12'h0000h}	
	Command Buffer Head Pointer Register for GuestID. 268
VFMMIO Offset {16'b[GuestID], 12'h0008h}	
	Command Buffer Tail Pointer Register for GuestID. 268
VFMMIO Offset {16'b[GuestID], 12'h0010h}	
	Event Log Head Pointer Register for GuestID. 268
VFMMIO Offset {16'b[GuestID], 12'h0018h}	
	Event Log Tail Pointer Register for GuestID. 268
VFMMIO Offset {16'b[GuestID], 12'h0020h}	
	vIOMMU Status Register for GuestID. 269
VFMMIO Offset {16'b[GuestID], 12'h0030h}	
	IOMMU PPR Log Head Pointer Register for GuestID. 269
VFMMIO Offset {16'b[GuestID], 12'h0038h}	
	IOMMU PPR Log Tail Pointer Register for GuestID. 269
VFMMIO Offset {16'b[GuestID], 12'h0040h} Reserved. 269	
VFMMIO Offset {16'b[GuestID], 12'h0048h} Reserved. 269	
VFMMIO Offset {16'b[GuestID], 12'h0050h} PPR Log B Head Pointer Register for GuestID. 269	
VFMMIO Offset {16'b[GuestID], 12'h0058h} PPR Log B Tail Pointer Register for GuestID. 269	
VFMMIO Offset {16'b[GuestID], 12'h0070h} Event Log B Head Pointer Register for GuestID. 269	
VFMMIO Offset {16'b[GuestID], 12'h0078h} Event Log B Tail Pointer Register for GuestID. 269	
VFMMIO Offset {16'b[GuestID], 12'h0080h} PPR Log Auto Response Register for GuestID. 269	
VFMMIO Offset {16'b[GuestID], 12'h0088h}	
	PPR Log Overflow Early Indicator Register for GuestID. 269
VFMMIO Offset {16'b[GuestID], 12'h0090h}	
	PPR Log B Overflow Early Indicator Register for GuestID. 270