



# AMD64 Technology

## AMD64 Architecture Programmer's Manual

### Volume 2: System Programming

Publication No.	Revision	Date
24593	3.25	June 2015

The information contained herein is for informational purposes only, and is subject to change without notice. While every precaution has been taken in the preparation of this document, it may contain technical inaccuracies, omissions and typographical errors, and AMD is under no obligation to update or otherwise correct this information. Advanced Micro Devices, Inc. makes no representations or warranties with respect to the accuracy or completeness of the contents of this document, and assumes no liability of any kind, including the implied warranties of noninfringement, merchantability or fitness for particular purposes, with respect to the operation or use of AMD hardware, software or other products described herein. No license, including implied or arising by estoppel, to any intellectual property rights is granted by this document. Terms and limitations applicable to the purchase or use of AMD's products are as set forth in a signed agreement between the parties or in AMD's Standard Terms and Conditions of Sale.

## **Trademarks**

AMD, the AMD arrow logo, and combinations thereof, AMD Virtualization and 3DNow! are trademarks of Advanced Micro Devices, Inc. Other product names used in this publication are for identification purposes only and may be trademarks of their respective companies.

MMX is a trademark and Pentium is a registered trademark of Intel Corporation.

HyperTransport is a licensed trademark of the HyperTransport Technology Consortium.

# Contents

---

<b>Contents</b> .....	<b>iii</b>
<b>Figures</b> .....	<b>xvii</b>
<b>Tables</b> .....	<b>xxv</b>
<b>Revision History</b> .....	<b>xxix</b>
<b>Preface</b> .....	<b>xxxiii</b>
About This Book .....	xxxiii
Audience .....	xxxiii
Organization .....	xxxiii
Conventions and Definitions .....	xxxiv
Notational Conventions .....	xxxv
Definitions .....	xxxvi
Registers .....	xlii
Endian Order .....	xlvi
Related Documents .....	xlvi
<b>1 System-Programming Overview</b> .....	<b>1</b>
1.1 Memory Model .....	1
Memory Addressing .....	2
Memory Organization .....	3
Canonical Address Form .....	4
1.2 Memory Management .....	5
Segmentation .....	5
Paging .....	7
Mixing Segmentation and Paging .....	8
Real Addressing .....	10
1.3 Operating Modes .....	11
Long Mode .....	12
64-Bit Mode .....	13
Compatibility Mode .....	13
Legacy Modes .....	14
System Management Mode (SMM) .....	15
1.4 System Registers .....	15
1.5 System-Data Structures .....	17
1.6 Interrupts .....	19
1.7 Additional System-Programming Facilities .....	20
Hardware Multitasking .....	20
Machine Check .....	21
Software Debugging .....	21
Performance Monitoring .....	22
<b>2 x86 and AMD64 Architecture Differences</b> .....	<b>23</b>
2.1 Operating Modes .....	23
Long Mode .....	23

	Legacy Mode . . . . .	23
	System-Management Mode . . . . .	24
2.2	Memory Model . . . . .	24
	Memory Addressing . . . . .	24
	Page Translation . . . . .	25
	Segmentation . . . . .	26
2.3	Protection Checks . . . . .	27
2.4	Registers . . . . .	28
	General-Purpose Registers . . . . .	28
	YMM/XMM Registers . . . . .	28
	Flags Register . . . . .	28
	Instruction Pointer . . . . .	28
	Stack Pointer . . . . .	28
	Control Registers . . . . .	29
	Debug Registers . . . . .	29
	Extended Feature Register (EFER) . . . . .	29
	Memory Type Range Registers (MTRRs) . . . . .	29
	Other Model-Specific Registers (MSRs) . . . . .	29
2.5	Instruction Set . . . . .	29
	REX Prefixes . . . . .	29
	Segment-Override Prefixes in 64-Bit Mode . . . . .	30
	Operands and Results . . . . .	30
	Address Calculations . . . . .	30
	Instructions that Reference RSP . . . . .	31
	Branches . . . . .	32
	NOP Instruction . . . . .	34
	Single-Byte INC and DEC Instructions . . . . .	34
	MOVSXD Instruction . . . . .	34
	Invalid Instructions . . . . .	34
	Reassigned Opcodes . . . . .	36
	FXSAVE and FXRSTOR Instructions . . . . .	36
2.6	Interrupts and Exceptions . . . . .	36
	Interrupt Descriptor Table . . . . .	37
	Stack Frame Pushes . . . . .	37
	Stack Switching . . . . .	37
	IRET Instruction . . . . .	37
	Task-Priority Register (CR8) . . . . .	38
	New Exception Conditions . . . . .	38
2.7	Hardware Task Switching . . . . .	38
2.8	Long-Mode vs. Legacy-Mode Differences . . . . .	39
<b>3</b>	<b>System Resources . . . . .</b>	<b>41</b>
3.1	System-Control Registers . . . . .	41
	CR0 Register . . . . .	42
	CR2 and CR3 Registers . . . . .	45
	CR4 Register . . . . .	47
	Additional Control Registers in 64-Bit-Mode . . . . .	51
	CR8 (Task Priority Register, TPR) . . . . .	51

	RFLAGS Register . . . . .	52
	Extended Feature Enable Register (EFER) . . . . .	55
	Extended Control Registers (XCR <i>n</i> ) . . . . .	58
3.2	Model-Specific Registers (MSRs) . . . . .	58
	System Configuration Register (SYSCFG) . . . . .	59
	System-Linkage Registers . . . . .	61
	Memory-Typing Registers . . . . .	61
	Debug-Extension Registers . . . . .	62
	Performance-Monitoring Registers . . . . .	62
	Machine-Check Registers . . . . .	62
3.3	Processor Feature Identification . . . . .	63
<b>4</b>	<b>Segmented Virtual Memory . . . . .</b>	<b>65</b>
4.1	Real Mode Segmentation . . . . .	65
4.2	Virtual-8086 Mode Segmentation . . . . .	66
4.3	Protected Mode Segmented-Memory Models . . . . .	66
	Multi-Segmented Model . . . . .	66
	Flat-Memory Model . . . . .	67
	Segmentation in 64-Bit Mode . . . . .	67
4.4	Segmentation Data Structures and Registers . . . . .	67
4.5	Segment Selectors and Registers . . . . .	69
	Segment Selectors . . . . .	69
	Segment Registers . . . . .	70
	Segment Registers in 64-Bit Mode . . . . .	72
4.6	Descriptor Tables . . . . .	73
	Global Descriptor Table . . . . .	73
	Global Descriptor-Table Register . . . . .	74
	Local Descriptor Table . . . . .	75
	Local Descriptor-Table Register . . . . .	76
	Interrupt Descriptor Table . . . . .	78
	Interrupt Descriptor-Table Register . . . . .	79
4.7	Legacy Segment Descriptors . . . . .	80
	Descriptor Format . . . . .	80
	Code-Segment Descriptors . . . . .	82
	Data-Segment Descriptors . . . . .	83
	System Descriptors . . . . .	85
	Gate Descriptors . . . . .	86
4.8	Long-Mode Segment Descriptors . . . . .	88
	Code-Segment Descriptors . . . . .	88
	Data-Segment Descriptors . . . . .	89
	System Descriptors . . . . .	90
	Gate Descriptors . . . . .	92
	Long Mode Descriptor Summary . . . . .	94
4.9	Segment-Protection Overview . . . . .	95
	Privilege-Level Concept . . . . .	96
	Privilege-Level Types . . . . .	96
4.10	Data-Access Privilege Checks . . . . .	97
	Accessing Data Segments . . . . .	97

	Accessing Stack Segments. . . . .	98
4.11	Control-Transfer Privilege Checks . . . . .	100
	Direct Control Transfers . . . . .	100
	Control Transfers Through Call Gates. . . . .	104
	Return Control Transfers . . . . .	111
4.12	Limit Checks . . . . .	112
	Determining Limit Violations . . . . .	112
	Data Limit Checks in 64-bit Mode . . . . .	114
4.13	Type Checks . . . . .	114
	Type Checks in Legacy and Compatibility Modes . . . . .	114
	Long Mode Type Check Differences. . . . .	115
<b>5</b>	<b>Page Translation and Protection . . . . .</b>	<b>117</b>
5.1	Page Translation Overview . . . . .	118
	Page-Translation Options . . . . .	120
	Page-Translation Enable (PG) Bit . . . . .	120
	Physical-Address Extensions (PAE) Bit . . . . .	121
	Page-Size Extensions (PSE) Bit . . . . .	121
	Page-Directory Page Size (PS) Bit . . . . .	122
5.2	Legacy-Mode Page Translation. . . . .	122
	CR3 Register . . . . .	123
	Normal (Non-PAE) Paging . . . . .	124
	PAE Paging . . . . .	126
5.3	Long-Mode Page Translation . . . . .	130
	Canonical Address Form . . . . .	130
	CR3 . . . . .	130
	4-Kbyte Page Translation . . . . .	131
	2-Mbyte Page Translation . . . . .	134
	1-Gbyte Page Translation . . . . .	135
5.4	Page-Translation-Table Entry Fields. . . . .	137
	Field Definitions . . . . .	138
	Notes on Access and Dirty Bits. . . . .	141
5.5	Translation-Lookaside Buffer (TLB) . . . . .	141
	Global Pages . . . . .	142
	TLB Management . . . . .	142
5.6	Page-Protection Checks. . . . .	145
	User/Supervisor (U/S) Bit . . . . .	145
	Read/Write (R/W) Bit . . . . .	146
	No Execute (NX) Bit . . . . .	146
	Write Protect (CR0.WP) Bit . . . . .	146
	Supervisor-Mode Execution Prevention (CR4.SMEP) Bit . . . . .	146
5.7	Protection Across Paging Hierarchy . . . . .	147
	Access to User Pages when CR0.WP=1 . . . . .	148
5.8	Effects of Segment Protection . . . . .	148
<b>6</b>	<b>System-Management Instructions . . . . .</b>	<b>149</b>
6.1	Fast System Call and Return . . . . .	152
	SYSCALL and SYSRET. . . . .	152

	SYSENTER and SYSEXIT (Legacy Mode Only) . . . . .	154
	SWAPGS Instruction . . . . .	155
6.2	System Status and Control . . . . .	155
	Processor Feature Identification (CPUID) . . . . .	155
	Accessing Control Registers . . . . .	155
	Accessing the RFLAGS Register . . . . .	156
	Accessing Debug Registers . . . . .	156
	Accessing Model-Specific Registers . . . . .	156
6.3	Segment Register and Descriptor Register Access . . . . .	157
	Accessing Segment Registers . . . . .	157
	Accessing Segment Register Hidden State . . . . .	157
	Accessing Descriptor-Table Registers . . . . .	158
6.4	Protection Checking . . . . .	158
	Checking Access Rights . . . . .	158
	Checking Segment Limits . . . . .	158
	Checking Read/Write Rights . . . . .	158
	Adjusting Access Rights . . . . .	159
6.5	Processor Halt . . . . .	159
6.6	Cache and TLB Management . . . . .	159
	Cache Management . . . . .	159
	TLB Invalidation . . . . .	160
<b>7</b>	<b>Memory System . . . . .</b>	<b>161</b>
7.1	Single-Processor Memory Access Ordering . . . . .	164
	Read Ordering . . . . .	164
	Write Ordering . . . . .	165
	Read/Write Barriers . . . . .	165
7.2	Multiprocessor Memory Access Ordering . . . . .	166
7.3	Memory Coherency and Protocol . . . . .	169
	Special Coherency Considerations . . . . .	171
7.4	Memory Types . . . . .	172
	Memory Barrier Interaction with Memory Types . . . . .	175
7.5	Buffering and Combining Memory Writes . . . . .	177
	Write Buffering . . . . .	177
	Write Combining . . . . .	178
7.6	Memory Caches . . . . .	179
	Cache Organization and Operation . . . . .	179
	Cache Control Mechanisms . . . . .	182
	Cache and Memory Management Instructions . . . . .	184
	Serializing Instructions . . . . .	185
	Cache and Processor Topology . . . . .	186
7.7	Memory-Type Range Registers . . . . .	187
	MTRR Type Fields . . . . .	187
	MTRRs . . . . .	189
	Using MTRRs . . . . .	196
	MTRRs and Page Cache Controls . . . . .	197
	MTRRs in Multi-Processing Environments . . . . .	198
7.8	Page-Attribute Table Mechanism . . . . .	199

	PAT Register	199
	PAT Indexing	200
	Identifying PAT Support	201
	PAT Accesses	201
	Combined Effect of MTRRs and PAT	202
	PATs in Multi-Processing Environments	203
	Changing Memory Type	203
7.9	Memory-Mapped I/O	203
	Extended Fixed-Range MTRR Type-Field Encodings	204
	IORRs	206
	IORR Overlapping	208
	Top of Memory	208
<b>8</b>	<b>Exceptions and Interrupts</b>	<b>211</b>
8.1	General Characteristics	211
	Precision	211
	Instruction Restart	212
	Types of Exceptions	212
	Masking External Interrupts	213
	Masking Floating-Point and Media Instructions	213
	Disabling Exceptions	213
8.2	Vectors	214
	#DE—Divide-by-Zero-Error Exception (Vector 0)	217
	#DB—Debug Exception (Vector 1)	217
	NMI—Non-Maskable-Interrupt Exception (Vector 2)	218
	#BP—Breakpoint Exception (Vector 3)	218
	#OF—Overflow Exception (Vector 4)	219
	#BR—Bound-Range Exception (Vector 5)	219
	#UD—Invalid-Opcode Exception (Vector 6)	219
	#NM—Device-Not-Available Exception (Vector 7)	220
	#DF—Double-Fault Exception (Vector 8)	220
	Coprocessor-Segment-Overrun Exception (Vector 9)	221
	#TS—Invalid-TSS Exception (Vector 10)	222
	#NP—Segment-Not-Present Exception (Vector 11)	223
	#SS—Stack Exception (Vector 12)	223
	#GP—General-Protection Exception (Vector 13)	224
	#PF—Page-Fault Exception (Vector 14)	225
	#MF—x87 Floating-Point Exception-Pending (Vector 16)	226
	#AC—Alignment-Check Exception (Vector 17)	227
	#MC—Machine-Check Exception (Vector 18)	228
	#XF—SIMD Floating-Point Exception (Vector 19)	229
	#SX—Security Exception (Vector 30)	229
	User-Defined Interrupts (Vectors 32–255)	230
8.3	Exceptions During a Task Switch	230
8.4	Error Codes	230
	Selector-Error Code	231
	Page-Fault Error Code	231
8.5	Priorities	232



	Floating-Point Exception Priorities . . . . .	233
	External Interrupt Priorities . . . . .	234
8.6	Real-Mode Interrupt Control Transfers . . . . .	235
8.7	Legacy Protected-Mode Interrupt Control Transfers . . . . .	237
	Locating the Interrupt Handler . . . . .	238
	Interrupt To Same Privilege . . . . .	239
	Interrupt To Higher Privilege . . . . .	240
	Privilege Checks . . . . .	241
	Returning From Interrupt Procedures . . . . .	244
8.8	Virtual-8086 Mode Interrupt Control Transfers . . . . .	244
	Protected-Mode Handler Control Transfer . . . . .	245
	Virtual-8086 Handler Control Transfer . . . . .	247
8.9	Long-Mode Interrupt Control Transfers . . . . .	247
	Interrupt Gates and Trap Gates . . . . .	247
	Locating the Interrupt Handler . . . . .	248
	Interrupt Stack Frame . . . . .	249
	Interrupt-Stack Table . . . . .	251
	Returning From Interrupt Procedures . . . . .	253
8.10	Virtual Interrupts . . . . .	253
	Virtual-8086 Mode Extensions . . . . .	254
	Protected Mode Virtual Interrupts . . . . .	257
	Effect of Instructions that Modify EFLAGS.IF . . . . .	257
<b>9</b>	<b>Machine Check Architecture . . . . .</b>	<b>261</b>
9.1	Introduction . . . . .	261
	Reliability, Availability, and Serviceability . . . . .	261
	Error Detection, Logging, and Reporting . . . . .	262
	Error Recovery . . . . .	264
9.2	Determining Machine-Check Architecture Support . . . . .	265
9.3	Machine Check Architecture MSRs . . . . .	265
	Global Status and Control Registers . . . . .	266
	Error-Reporting Register Banks . . . . .	269
9.4	Initializing the Machine-Check Mechanism . . . . .	277
9.5	Using MCA Features . . . . .	278
	Determining the Scope of Detected Errors . . . . .	279
	Handling Machine Check Exceptions . . . . .	279
	Reporting Corrected Errors . . . . .	281
<b>10</b>	<b>System-Management Mode . . . . .</b>	<b>283</b>
10.1	SMM Differences . . . . .	283
10.2	SMM Resources . . . . .	284
	SMRAM . . . . .	284
	SMBASE Register . . . . .	285
	SMRAM State-Save Area . . . . .	286
	SMM-Revision Identifier . . . . .	290
	SMRAM Protected Area . . . . .	291
10.3	Using SMM . . . . .	293
	System-Management Interrupt (SMI) . . . . .	293

	SMM Operating-Environment . . . . .	293
	Exceptions and Interrupts . . . . .	294
	Invalidating the Caches . . . . .	295
	Saving Additional Processor State . . . . .	295
	Operating in Protected Mode and Long Mode . . . . .	296
	Auto-Halt Restart . . . . .	296
	I/O Instruction Restart . . . . .	297
10.4	Leaving SMM . . . . .	298
<b>11</b>	<b>SSE, MMX, and x87 Programming . . . . .</b>	<b>301</b>
11.1	Overview of System-Software Considerations . . . . .	301
11.2	Determining Media and x87 Feature Support . . . . .	301
11.3	Enabling SSE Instructions . . . . .	303
	Enabling Legacy SSE Instruction Execution . . . . .	303
	Enabling Extended SSE Instruction Execution . . . . .	303
	SIMD Floating-Point Exception Handling . . . . .	304
11.4	Media and x87 Processor State . . . . .	304
	SSE Execution Unit State . . . . .	304
	MMX Execution Unit State . . . . .	305
	x87 Execution Unit State . . . . .	306
	Saving Media and x87 Execution Unit State . . . . .	308
11.5	XSAVE/XRSTOR Instructions . . . . .	315
	CPUID Enhancements . . . . .	315
	XFEATURE_ENABLED_MASK . . . . .	315
	Extended Save Area . . . . .	316
	Instruction Functions . . . . .	317
	YMM States and Supported Operating Modes . . . . .	317
	Extended SSE Execution State Management . . . . .	317
	Saving Processor State . . . . .	319
	Restoring Processor State . . . . .	319
	MXCSR State Management . . . . .	319
	Mode-Specific XSAVE/XRSTOR State Management . . . . .	319
<b>12</b>	<b>Task Management . . . . .</b>	<b>327</b>
12.1	Hardware Multitasking Overview . . . . .	327
12.2	Task-Management Resources . . . . .	328
	TSS Selector . . . . .	330
	TSS Descriptor . . . . .	330
	Task Register . . . . .	331
	Legacy Task-State Segment . . . . .	333
	64-Bit Task State Segment . . . . .	337
	Task Gate Descriptor (Legacy Mode Only) . . . . .	340
12.3	Hardware Task-Management in Legacy Mode . . . . .	340
	Task Memory-Mapping . . . . .	340
	Switching Tasks . . . . .	341
	Task Switches Using Task Gates . . . . .	343
	Nesting Tasks . . . . .	345
<b>13</b>	<b>Software Debug and Performance Resources . . . . .</b>	<b>347</b>

13.1	Software-Debug Resources . . . . .	348
	Debug Registers . . . . .	348
	Setting Breakpoints . . . . .	355
	Using Breakpoints . . . . .	357
	Single Stepping . . . . .	360
	Breakpoint Instruction (INT3) . . . . .	360
	Control-Transfer Breakpoint Features . . . . .	360
13.2	Performance Monitoring Counters . . . . .	362
	Performance Counter MSRs . . . . .	362
	Detecting Hardware Support for Performance Counters . . . . .	368
	Using Performance Counters . . . . .	369
	Time-Stamp Counter . . . . .	369
13.3	Instruction-Based Sampling . . . . .	371
	IBS Fetch Sampling . . . . .	371
	IBS Fetch Sampling Registers . . . . .	372
	IBS Execution Sampling . . . . .	375
	IBS Execution Sampling Registers . . . . .	376
13.4	Lightweight Profiling . . . . .	384
	Overview . . . . .	384
	Events and Event Records . . . . .	388
	Detecting LWP . . . . .	398
	LWP Registers . . . . .	402
	LWP Instructions . . . . .	404
	LWP Control Block . . . . .	408
	XSAVE/XRSTOR . . . . .	418
	Implementation Notes . . . . .	422
<b>14</b>	<b>Processor Initialization and Long Mode Activation . . . . .</b>	<b>427</b>
14.1	Processor Initialization . . . . .	427
	Built-In Self Test (BIST) . . . . .	427
	Clock Multiplier Selection . . . . .	428
	Processor Initialization State . . . . .	428
	Multiple Processor Initialization . . . . .	430
	Fetching the First Instruction . . . . .	430
14.2	Hardware Configuration . . . . .	431
	Processor Implementation Information . . . . .	431
	Enabling Internal Caches . . . . .	431
	Initializing Media and x87 Processor State . . . . .	431
	Model-Specific Initialization . . . . .	433
14.3	Initializing Real Mode . . . . .	434
14.4	Initializing Protected Mode . . . . .	434
14.5	Initializing Long Mode . . . . .	435
14.6	Enabling and Activating Long Mode . . . . .	436
	Activating Long Mode . . . . .	437
	Consistency Checks . . . . .	437
	Updating System Descriptor Table References . . . . .	438
	Relocating Page-Translation Tables . . . . .	438
14.7	Leaving Long Mode . . . . .	439

14.8	Long-Mode Initialization Example . . . . .	439
<b>15</b>	<b>Secure Virtual Machine. . . . .</b>	<b>445</b>
15.1	The Virtual Machine Monitor . . . . .	445
15.2	SVM Hardware Overview . . . . .	445
	Virtualization Support . . . . .	445
	Guest Mode . . . . .	445
	External Access Protection . . . . .	446
	Interrupt Support . . . . .	446
	Restartable Instructions . . . . .	446
	Security Support . . . . .	446
15.3	SVM Processor and Platform Extensions . . . . .	446
15.4	Enabling SVM . . . . .	447
15.5	VMRUN Instruction . . . . .	447
	Basic Operation . . . . .	448
15.6	#VMEXIT . . . . .	452
15.7	Intercept Operation . . . . .	453
	State Saved on Exit . . . . .	454
	Intercepts During IDT Interrupt Delivery . . . . .	454
	EXITINTINFO Pseudo-Code . . . . .	456
15.8	Decode Assists . . . . .	457
	MOV CRx/DRx Intercepts . . . . .	457
	INTn Intercepts . . . . .	457
	INVLPG and INVLPGA Intercepts . . . . .	458
	Nested and intercepted #PF . . . . .	458
15.9	Instruction Intercepts . . . . .	459
15.10	IOIO Intercepts . . . . .	461
	I/O Permissions Map . . . . .	461
	IN and OUT Behavior . . . . .	462
	(REP) OUTS and INS . . . . .	462
15.11	MSR Intercepts . . . . .	463
15.12	Exception Intercepts . . . . .	464
	#DE (Divide By Zero) . . . . .	464
	#DB (Debug) . . . . .	465
	Vector 2 (Reserved) . . . . .	465
	#BP (Breakpoint) . . . . .	465
	#OF (Overflow) . . . . .	465
	#BR (Bound-Range) . . . . .	465
	#UD (Invalid Opcode) . . . . .	465
	#NM (Device-Not-Available) . . . . .	465
	#DF (Double Fault) . . . . .	465
	Vector 9 (Reserved) . . . . .	466
	#TS (Invalid TSS) . . . . .	466
	#NP (Segment Not Present) . . . . .	466
	#SS (Stack Fault) . . . . .	466
	#GP (General Protection) . . . . .	466
	#PF (Page Fault) . . . . .	466
	#MF (X87 Floating Point) . . . . .	466

	#AC (Alignment Check) . . . . .	466
	#MC (Machine Check) . . . . .	467
	#XF (SIMD Floating Point) . . . . .	467
15.13	Interrupt Intercepts . . . . .	467
	INTR Intercept . . . . .	467
	NMI Intercept . . . . .	467
	SMI Intercept . . . . .	467
	INIT Intercept . . . . .	468
	Virtual Interrupt Intercept . . . . .	468
15.14	Miscellaneous Intercepts . . . . .	469
	Task Switch Intercept . . . . .	469
	Ferr_Freeze Intercept . . . . .	469
	Shutdown Intercept . . . . .	469
	Pause Intercept Filtering . . . . .	469
15.15	VMCB State Caching . . . . .	470
	VMCB Clean Bits . . . . .	471
	Guidelines for Clearing VMCB Clean Bits . . . . .	471
	VMCB Clean Field . . . . .	472
15.16	TLB Control . . . . .	473
	TLB Flush . . . . .	473
	Invalidate Page, Alternate ASID . . . . .	474
15.17	Global Interrupt Flag, STGI and CLGI Instructions . . . . .	474
15.18	VMMCALL Instruction . . . . .	475
15.19	Paged Real Mode . . . . .	476
15.20	Event Injection . . . . .	476
15.21	Interrupt and Local APIC Support . . . . .	477
	Physical (INTR) Interrupt Masking in EFLAGS . . . . .	477
	Virtualizing APIC.TPR . . . . .	478
	TPR Access in 32-Bit Mode . . . . .	478
	Injecting Virtual (INTR) Interrupts . . . . .	478
	Interrupt Shadows . . . . .	479
	Virtual Interrupt Intercept . . . . .	480
	Interrupt Masking in Local APIC . . . . .	480
	INIT Support . . . . .	480
	NMI Support . . . . .	481
15.22	SMM Support . . . . .	481
	Sources of SMI . . . . .	481
	Response to SMI . . . . .	481
	Containerizing Platform SMM . . . . .	482
15.23	Last Branch Record Virtualization . . . . .	483
	Hardware Acceleration for LBR Virtualization . . . . .	484
	LBR Virtualization CPUID Feature Detection . . . . .	484
15.24	External Access Protection . . . . .	484
	Device IDs and Protection Domains . . . . .	484
	Device Exclusion Vector (DEV) . . . . .	484
	Access Checking . . . . .	485
	DEV Capability Block . . . . .	486

	DEV Register Access Mechanism . . . . .	487
	DEV Control and Status Registers . . . . .	488
	Unauthorized Access Logging . . . . .	490
	Secure Initialization Support . . . . .	490
15.25	Nested Paging . . . . .	491
	Traditional Paging versus Nested Paging . . . . .	491
	Replicated State . . . . .	492
	Enabling Nested Paging . . . . .	493
	Nested Paging and VMRUN/#VMEXIT . . . . .	493
	Nested Table Walk . . . . .	493
	Nested versus Guest Page Faults, Fault Ordering . . . . .	494
	Combining Nested and Guest Attributes . . . . .	495
	Combining Memory Types, MTRRs . . . . .	495
	Page Splintering . . . . .	497
	Legacy PAE Mode . . . . .	497
	A20 Masking . . . . .	498
	Detecting Nested Paging Support . . . . .	498
15.26	Security . . . . .	498
15.27	Secure Startup with SKINIT . . . . .	498
	Secure Loader . . . . .	498
	Secure Loader Image . . . . .	499
	Secure Loader Block . . . . .	499
	Trusted Platform Module . . . . .	500
	System Interface, Memory Controller and I/O Hub Logic . . . . .	501
	SKINIT Operation . . . . .	501
	SL Abort . . . . .	502
	Secure Multiprocessor Initialization . . . . .	502
15.28	Security Exception (#SX) . . . . .	503
15.29	Advanced Virtual Interrupt Controller . . . . .	504
	Introduction . . . . .	504
	Architectural Definition . . . . .	505
15.30	SVM Related MSRs . . . . .	524
	VM_CR MSR (C001_0114h) . . . . .	524
	IGNNE MSR (C001_0115h) . . . . .	525
	SMM_CTL MSR (C001_0116h) . . . . .	525
	VM_HSAVE_PA MSR (C001_0117h) . . . . .	526
	TSC Ratio MSR (C000_0104h) . . . . .	526
15.31	SVM-Lock . . . . .	527
	SVM_KEY MSR (C001_0118h) . . . . .	527
15.32	SMM-Lock . . . . .	528
	SmmLock Bit — HWCR[0] . . . . .	528
	SMM_KEY MSR (C001_0119h) . . . . .	528
15.33	Nested Virtualization . . . . .	528
	VMSAVE and VMLOAD . . . . .	529
	Virtual GIF . . . . .	529
<b>16</b>	<b>Advanced Programmable Interrupt Controller (APIC) . . . . .</b>	<b>531</b>
16.1	Sources of Interrupts to the Local APIC . . . . .	532

16.2	Interrupt Control .....	533
16.3	Local APIC .....	533
	Local APIC Enable .....	533
	APIC Registers .....	534
	Local APIC ID .....	535
	APIC Version Register .....	536
	Extended APIC Feature Register .....	537
	Extended APIC Control Register .....	537
16.4	Local Interrupts .....	538
	APIC Timer Interrupt .....	540
	Local Interrupts LINT0 and LINT1 .....	542
	Performance Monitor Counter Interrupts .....	542
	Thermal Sensor Interrupts .....	543
	Extended Interrupts .....	543
	APIC Error Interrupts .....	543
	Spurious Interrupts .....	545
16.5	Interprocessor Interrupts (IPI) .....	545
16.6	Local APIC Handling of Interrupts .....	549
	Receiving System and IPI Interrupts .....	549
	Lowest Priority Messages and Arbitration .....	550
	Accepting System and IPI Interrupts .....	551
	Selecting and Handling Interrupts .....	554
16.7	SVM Support for Interrupts and the Local APIC .....	556
	Specific End of Interrupt Register .....	556
	Interrupt Enable Register .....	557
<b>17</b>	<b>Hardware Performance Monitoring and Control .....</b>	<b>559</b>
17.1	P-State Control .....	559
17.2	Core Performance Boost .....	561
17.3	Determining Processor Effective Frequency .....	562
	Actual Performance Frequency Clock Count (APERF) .....	564
	Maximum Performance Frequency Clock Count (MPERF) .....	564
	MPERF Read-only (MperfReadOnly) .....	564
17.4	Processor Feedback Interface .....	565
17.5	Processor Core Power Reporting .....	565
	Processor Facilities .....	565
	Software Algorithm .....	566
<b>Appendix A</b>	<b>MSR Cross-Reference .....</b>	<b>567</b>
A.1	MSR Cross-Reference by MSR Address .....	567
A.2	System-Software MSRs .....	571
A.3	Memory-Typing MSRs .....	572
A.4	Machine-Check MSRs .....	574
A.5	Software-Debug MSRs .....	575
A.6	Performance-Monitoring MSRs .....	576
A.7	Secure Virtual Machine MSRs .....	577
A.8	System Management Mode MSRs .....	578
A.9	CPUID Name MSR Cross-Reference .....	578

<b>Appendix B</b>	<b>Layout of VMCB</b> .....	<b>579</b>
<b>Appendix C</b>	<b>SVM Intercept Exit Codes</b> .....	<b>587</b>
<b>Appendix D</b>	<b>SMM Containerization</b> .....	<b>589</b>
D.1	SMM Containerization Pseudocode .....	589
<b>Appendix E</b>	<b>OS-Visible Workarounds</b> .....	<b>595</b>
E.1	Erratum Process Overview .....	597
<b>Index</b>	.....	<b>599</b>



# Figures

---

Figure 1-1.	Segmented-Memory Model . . . . .	6
Figure 1-2.	Flat Memory Model . . . . .	7
Figure 1-3.	Paged Memory Model. . . . .	8
Figure 1-4.	64-Bit Flat, Paged-Memory Model. . . . .	9
Figure 1-5.	Real-Address Memory Model. . . . .	10
Figure 1-6.	Operating Modes of the AMD64 Architecture . . . . .	12
Figure 1-7.	System Registers. . . . .	16
Figure 1-8.	System-Data Structures. . . . .	18
Figure 3-1.	Control Register 0 (CR0) . . . . .	43
Figure 3-2.	Control Register 2 (CR2)—Legacy-Mode . . . . .	46
Figure 3-3.	Control Register 2 (CR2)—Long Mode . . . . .	46
Figure 3-4.	Control Register 3 (CR3)—Legacy-Mode Non-PAE Paging. . . . .	46
Figure 3-5.	Control Register 3 (CR3)—Legacy-Mode PAE Paging. . . . .	46
Figure 3-6.	Control Register 3 (CR3)—Long Mode . . . . .	47
Figure 3-7.	Control Register 4 (CR4) . . . . .	48
Figure 3-8.	RFLAGS Register. . . . .	52
Figure 3-9.	Extended Feature Enable Register (EFER). . . . .	56
Figure 3-10.	AMD64 Architecture Model-Specific Registers. . . . .	59
Figure 3-11.	System-Configuration Register (SYSCFG) . . . . .	60
Figure 4-1.	Segmentation Data Structures. . . . .	68
Figure 4-2.	Segment and Descriptor-Table Registers . . . . .	69
Figure 4-3.	Segment Selector. . . . .	69
Figure 4-4.	Segment-Register Format . . . . .	71
Figure 4-5.	FS and GS Segment-Register Format—64-Bit Mode. . . . .	72
Figure 4-6.	Global and Local Descriptor-Table Access . . . . .	74
Figure 4-7.	GDTR and IDTR Format—Legacy Modes . . . . .	75
Figure 4-8.	GDTR and IDTR Format—Long Mode . . . . .	75
Figure 4-9.	Relationship between the LDT and GDT . . . . .	76
Figure 4-10.	LDTR Format—Legacy Mode . . . . .	77
Figure 4-11.	LDTR Format—Long Mode. . . . .	77
Figure 4-12.	Indexing an IDT . . . . .	79

Figure 4-13. Generic Segment Descriptor—Legacy Mode . . . . .	80
Figure 4-14. Code-Segment Descriptor—Legacy Mode . . . . .	82
Figure 4-15. Data-Segment Descriptor—Legacy Mode . . . . .	83
Figure 4-16. LDT and TSS Descriptor—Legacy/Compatibility Modes . . . . .	86
Figure 4-17. Call-Gate Descriptor—Legacy Mode . . . . .	87
Figure 4-18. Interrupt-Gate and Trap-Gate Descriptors—Legacy Mode . . . . .	87
Figure 4-19. Task-Gate Descriptor—Legacy Mode . . . . .	87
Figure 4-20. Code-Segment Descriptor—Long Mode . . . . .	88
Figure 4-21. Data-Segment Descriptor—Long Mode . . . . .	89
Figure 4-22. System-Segment Descriptor—64-Bit Mode . . . . .	91
Figure 4-23. Call-Gate Descriptor—Long Mode . . . . .	92
Figure 4-24. Interrupt-Gate and Trap-Gate Descriptors—Long Mode . . . . .	93
Figure 4-25. Privilege-Level Relationships . . . . .	96
Figure 4-26. Data-Access Privilege-Check Examples . . . . .	98
Figure 4-27. Stack-Access Privilege-Check Examples . . . . .	99
Figure 4-28. Nonconforming Code-Segment Privilege-Check Examples . . . . .	102
Figure 4-29. Conforming Code-Segment Privilege-Check Examples . . . . .	103
Figure 4-30. Legacy-Mode Call-Gate Transfer Mechanism . . . . .	104
Figure 4-31. Long-Mode Call-Gate Access Mechanism . . . . .	105
Figure 4-32. Privilege-Check Examples for Call Gates . . . . .	107
Figure 4-33. Legacy-Mode 32-Bit Stack Switch, with Parameters . . . . .	109
Figure 4-34. 32-Bit Stack Switch, No Parameters—Legacy Mode . . . . .	109
Figure 4-35. Stack Switch—Long Mode . . . . .	110
Figure 5-1. Virtual to Physical Address Translation—Long Mode . . . . .	119
Figure 5-2. Control Register 3 (CR3)—Non-PAE Paging Legacy-Mode . . . . .	123
Figure 5-3. Control Register 3 (CR3)—PAE Paging Legacy-Mode . . . . .	123
Figure 5-4. 4-Kbyte Non-PAE Page Translation—Legacy Mode . . . . .	124
Figure 5-5. 4-Kbyte PDE—Non-PAE Paging Legacy-Mode . . . . .	125
Figure 5-6. 4-Kbyte PTE—Non-PAE Paging Legacy-Mode . . . . .	125
Figure 5-7. 4-Mbyte Page Translation—Non-PAE Paging Legacy-Mode . . . . .	126
Figure 5-8. 4-Mbyte PDE—Non-PAE Paging Legacy-Mode . . . . .	126
Figure 5-9. 4-Kbyte PAE Page Translation—Legacy Mode . . . . .	127
Figure 5-10. 4-Kbyte PDPE—PAE Paging Legacy-Mode . . . . .	128

Figure 5-11.	4-Kbyte PDE—PAE Paging Legacy-Mode	128
Figure 5-12.	4-Kbyte PTE—PAE Paging Legacy-Mode	128
Figure 5-13.	2-Mbyte PAE Page Translation—Legacy Mode	129
Figure 5-14.	2-Mbyte PDPE—PAE Paging Legacy-Mode	129
Figure 5-15.	2-Mbyte PDE—PAE Paging Legacy-Mode	130
Figure 5-16.	Control Register 3 (CR3)—Long Mode	131
Figure 5-17.	4-Kbyte Page Translation—Long Mode	132
Figure 5-18.	4-Kbyte PML4E—Long Mode	133
Figure 5-19.	4-Kbyte PDPE—Long Mode	133
Figure 5-20.	4-Kbyte PDE—Long Mode	133
Figure 5-21.	4-Kbyte PTE—Long Mode	133
Figure 5-22.	2-Mbyte Page Translation—Long Mode	134
Figure 5-23.	2-Mbyte PML4E—Long Mode	135
Figure 5-24.	2-Mbyte PDPE—Long Mode	135
Figure 5-25.	2-Mbyte PDE—Long Mode	135
Figure 5-26.	1-Gbyte Page Translation—Long Mode	136
Figure 5-27.	1-Gbyte PML4E—Long Mode	137
Figure 5-28.	1-Gbyte PDPE—Long Mode	137
Figure 6-1.	STAR, LSTAR, CSTAR, and MASK MSRs	153
Figure 6-2.	SYSENTER_CS, SYSENTER_ESP, SYSENTER_EIP MSRs	154
Figure 7-1.	Processor and Memory System	162
Figure 7-2.	MOESI State Transitions	170
Figure 7-3.	Cache Organization Example	180
Figure 7-4.	MTRR Mapping of Physical Memory	190
Figure 7-5.	Fixed-Range MTRR	191
Figure 7-6.	MTRRphysBase $n$ Register	193
Figure 7-7.	MTRRphysMask $n$ Register	193
Figure 7-8.	MTRR defType Register Format	195
Figure 7-9.	MTRR Capability Register Format	196
Figure 7-10.	PAT Register	199
Figure 7-11.	Extended MTRR Type-Field Format (Fixed-Range MTRRs)	204
Figure 7-12.	IORRBase $n$ Register	207
Figure 7-13.	IORRMask $n$ Register	208

Figure 7-14. Memory Organization Using Top-of-Memory Registers . . . . .	209
Figure 7-15. Top-of-Memory Registers (TOP_MEM, TOP_MEM2). . . . .	209
Figure 8-1. Control Register 2 (CR2) . . . . .	226
Figure 8-2. Selector Error Code. . . . .	231
Figure 8-3. Page-Fault Error Code . . . . .	231
Figure 8-4. Task Priority Register (CR8) . . . . .	235
Figure 8-5. Real-Mode Interrupt Control Transfer . . . . .	236
Figure 8-6. Stack After Interrupt in Real Mode. . . . .	237
Figure 8-7. Protected-Mode Interrupt Control Transfer . . . . .	239
Figure 8-8. Stack After Interrupt to Same Privilege Level . . . . .	240
Figure 8-9. Stack After Interrupt to Higher Privilege . . . . .	241
Figure 8-10. Privilege-Check Examples for Interrupts . . . . .	243
Figure 8-11. Stack After Virtual-8086 Mode Interrupt to Protected Mode. . . . .	246
Figure 8-12. Long-Mode Interrupt Control Transfer. . . . .	248
Figure 8-13. Long-Mode Stack After Interrupt—Same Privilege. . . . .	250
Figure 8-14. Long-Mode Stack After Interrupt—Higher Privilege. . . . .	251
Figure 8-15. Long-Mode IST Mechanism. . . . .	252
Figure 9-1. MCG_CAP Register . . . . .	266
Figure 9-2. MCG_STATUS Register . . . . .	267
Figure 9-3. MCG_CTL Register . . . . .	268
Figure 9-4. CPU Watchdog Timer Register Format . . . . .	268
Figure 9-5. MCI_CTL Register . . . . .	271
Figure 9-6. MCI_STATUS Register . . . . .	272
Figure 9-7. MCI_MISC1 Addressing . . . . .	275
Figure 9-8. Miscellaneous Information Register (Thresholding Register Format). . . . .	276
Figure 10-1. Default SMRAM Memory Map . . . . .	285
Figure 10-2. SMBASE Register . . . . .	285
Figure 10-3. SMM-Revision Identifier . . . . .	291
Figure 10-4. SMM_ADDR Register Format . . . . .	292
Figure 10-5. SMM_MASK Register Format. . . . .	292
Figure 10-6. I/O Instruction Restart Dword. . . . .	298
Figure 11-1. SSE Execution Unit State . . . . .	305
Figure 11-2. MMX Execution Unit State . . . . .	306

Figure 11-3. x87 Execution Unit State .....	308
Figure 11-4. FSAVE/FNSAVE Image (32-Bit, Protected Mode) .....	310
Figure 11-5. FSAVE/FNSAVE Image (32-Bit, Real/Virtual-8086 Modes) .....	311
Figure 11-6. FSAVE/FNSAVE Image (16-Bit, Protected Mode) .....	312
Figure 11-7. FSAVE/FNSAVE Image (16-Bit, Real/Virtual-8086 Modes) .....	313
Figure 11-8. XFEATURE_ENABLED_MASK Register (XCR0) .....	316
Figure 11-9. FXSAVE and FXRSTOR Image (64-bit Mode) .....	321
Figure 11-10. FXSAVE and FXRSTOR Image (Non-64-bit Mode) .....	322
Figure 12-1. Task-Management Resources .....	329
Figure 12-2. Task-Segment Selector .....	330
Figure 12-3. TR Format, Legacy Mode .....	331
Figure 12-4. TR Format, Long Mode .....	332
Figure 12-5. Relationship between the TSS and GDT .....	332
Figure 12-6. Legacy 32-bit TSS .....	334
Figure 12-7. I/O-Permission Bitmap Example .....	337
Figure 12-8. Long Mode TSS Format .....	339
Figure 12-9. Task-Gate Descriptor, Legacy Mode Only .....	340
Figure 12-10. Privilege-Check Examples for Task Gates .....	344
Figure 13-1. Address-Breakpoint Registers (DR0–DR3) .....	349
Figure 13-2. Debug-Status Register (DR6) .....	350
Figure 13-3. Debug-Control Register (DR7) .....	351
Figure 13-4. Debug-Control MSR (DebugCtl) .....	354
Figure 13-5. Control-Transfer Recording MSRs .....	355
Figure 13-6. Performance Counter Format .....	363
Figure 13-7. Core Performance Event-Select Register (PerfEvtSel $n$ ) .....	365
Figure 13-8. Northbridge Performance Event-Select Register (NB_PerfEvtSel $n$ ) .....	367
Figure 13-9. L2 Cache Performance Event-Select Register (L2I_PerfEvtSel $n$ ) .....	368
Figure 13-10. Time-Stamp Counter (TSC) .....	370
Figure 13-11. IBS Fetch Control Register (IbsFetchCtl) .....	373
Figure 13-12. IBS Fetch Linear Address Register (IbsFetchLinAd) .....	374
Figure 13-13. IBS Fetch Physical Address Register (IbsFetchPhysAd) .....	375
Figure 13-14. IBS Execution Control Register (IbsOpCtl) .....	377
Figure 13-15. IBS Op Linear Address Register (IbsOpRip) .....	378

Figure 13-16. IBS Op Data 1 Register (IbsOpData1) . . . . .	379
Figure 13-17. IBS Op Data 3 Register (IbsOpData3) . . . . .	381
Figure 13-18. IBS Data Cache Linear Address Register (IbsDcLinAd) . . . . .	383
Figure 13-19. IBS Data Cache Physical Address Register (IbsDcPhysAd) . . . . .	383
Figure 13-20. IBS Branch Target Address Register (IbsBrTarget) . . . . .	384
Figure 13-21. Generic Event Record . . . . .	389
Figure 13-22. Programmed Value Sample Event Record . . . . .	390
Figure 13-23. Instructions Retired Event Record . . . . .	391
Figure 13-24. Branch Retired Event Record . . . . .	393
Figure 13-25. DCache Miss Event Record . . . . .	395
Figure 13-26. CPU Clocks not Halted Event Record . . . . .	396
Figure 13-27. CPU Reference Clocks not Halted Event Record . . . . .	397
Figure 13-28. Programmed Event Record . . . . .	398
Figure 13-29. LWP_CFG—Lightweight Profiling Features MSR . . . . .	403
Figure 13-30. LWPCB—Lightweight Profiling Control Block . . . . .	410
Figure 13-31. LWPCB Flags . . . . .	414
Figure 13-32. LWPCB Filters . . . . .	415
Figure 13-33. XSAVE Area for LWP . . . . .	419
Figure 15-1. EXITINTINFO for All Intercepts . . . . .	455
Figure 15-2. EXITINFO1 for IOIO Intercept . . . . .	462
Figure 15-3. EXITINFO1 for SMI Intercept . . . . .	468
Figure 15-4. Layout of VMCB Clean Field . . . . .	472
Figure 15-5. EVENTINJ Field in the VMCB . . . . .	477
Figure 15-6. Host Bridge DMA Checking . . . . .	486
Figure 15-7. Format of DEV_OP Register (in PCI Config Space) . . . . .	487
Figure 15-8. Format of DEV_CAP Register (in PCI Config Space) . . . . .	488
Figure 15-9. Format of DEV_BASE_HI[n] Registers . . . . .	489
Figure 15-10. Format of DEV_BASE_LO[n] Registers . . . . .	489
Figure 15-11. Format of DEV_MAP[n] Registers . . . . .	490
Figure 15-12. Address Translation with Traditional Paging . . . . .	491
Figure 15-13. Address Translation with Nested Paging . . . . .	492
Figure 15-14. SLB Example Layout . . . . .	500
Figure 15-15. vAPIC Backing Page Access . . . . .	506

Figure 15-16. Virtual APIC Task Priority Register Synchronization . . . . .	509
Figure 15-17. Physical APIC ID Table Entry . . . . .	514
Figure 15-18. Physical APIC Table in Memory. . . . .	515
Figure 15-19. Logical APIC ID Table Entry . . . . .	516
Figure 15-20. Logical APIC ID Table Format, Flat Mode. . . . .	517
Figure 15-21. Logical APIC ID Table Format, Cluster Mode. . . . .	518
Figure 15-22. Doorbell Register, MSR C001_011Bh . . . . .	521
Figure 15-23. EXITINFO1 . . . . .	522
Figure 15-24. EXITINFO2 . . . . .	522
Figure 15-25. Layout of VM_CR MSR (C001_0114h) . . . . .	524
Figure 15-26. Layout of SMM_CTL MSR (C001_0116h). . . . .	525
Figure 15-27. TSC Ratio MSR (C000_0104h) . . . . .	527
Figure 16-1. Block Diagram of a Typical APIC Implementation . . . . .	531
Figure 16-2. APIC Base Address Register (MSR 0000_001Bh). . . . .	534
Figure 16-3. APIC ID Register (APIC Offset 20h) . . . . .	536
Figure 16-4. APIC Version Register (APIC Offset 30h). . . . .	536
Figure 16-5. Extended APIC Feature Register (APIC Offset 400h) . . . . .	537
Figure 16-6. Extended APIC Control Register (APIC Offset 410h). . . . .	538
Figure 16-7. General Local Vector Table Register Format. . . . .	539
Figure 16-8. APIC Timer Local Vector Table Register (APIC Offset 320h) . . . . .	540
Figure 16-9. Timer Current Count Register (APIC Offset 390h) . . . . .	541
Figure 16-10. Timer Initial Count Register (APIC Offset 380h) . . . . .	541
Figure 16-11. Divide Configuration Register (APIC Offset 3E0h). . . . .	541
Figure 16-12. Local Interrupt 0/1 (LINT0/1) Local Vector Table Register (APIC Offset 350h/360h)542	
Figure 16-13. Performance Monitor Counter Local Vector Table Register (APIC Offset 340h)542	
Figure 16-14. Thermal Sensor Local Vector Table Register (APIC Offset 330h) . . . . .	543
Figure 16-15. APIC Error Local Vector Table Register (APIC Offset 370h). . . . .	543
Figure 16-16. APIC Error Status Register (APIC Offset 280h) . . . . .	544
Figure 16-17. Spurious Interrupt Register (APIC Offset F0h) . . . . .	545
Figure 16-18. Interrupt Command Register (APIC Offset 300h–3010h) . . . . .	546
Figure 16-19. Remote Read Register (APIC Offset C0h). . . . .	548

Figure 16-20. Logical Destination Register (APIC Offset D0h) . . . . .	549
Figure 16-21. Destination Format Register (APIC Offset E0h) . . . . .	550
Figure 16-22. Arbitration Priority Register (APIC Offset 90h). . . . .	551
Figure 16-23. Interrupt Request Register (APIC Offset 200h–270h) . . . . .	552
Figure 16-24. In Service Register (APIC Offset 100h–170h) . . . . .	553
Figure 16-25. Trigger Mode Register (APIC Offset 180h–1F0h). . . . .	553
Figure 16-26. Task Priority Register (APIC Offset 80h). . . . .	554
Figure 16-27. Processor Priority Register (APIC Offset A0h) . . . . .	555
Figure 16-28. End of Interrupt (APIC Offset B0h) . . . . .	556
Figure 16-29. Specific End of Interrupt (APIC Offset 420h) . . . . .	557
Figure 16-30. Interrupt Enable Register (APIC Offset 480h–4F0h) . . . . .	557
Figure 17-1. P-State Current Limit Register (MSR C001_0061h) . . . . .	560
Figure 17-2. P-State Control Register (MSR C001_0062h) . . . . .	560
Figure 17-3. P-State Status Register (MSR C001_0063h) . . . . .	561
Figure 17-4. Core Performance Boost (MSRC001_0015h) . . . . .	562
Figure 17-5. Actual Performance Frequency Count (MSR0000_00E8h) . . . . .	564
Figure 17-6. Max Performance Frequency Count (MSR0000_00E7h). . . . .	564
Figure 17-7. MPERF Read Only (MSR C000_00E7h). . . . .	564



## Tables

---

Table 1-1.	Operating Modes . . . . .	11
Table 1-2.	Interrupts and Exceptions . . . . .	20
Table 2-1.	Instructions That Reference RSP . . . . .	31
Table 2-2.	64-Bit Mode Near Branches, Default 64-Bit Operand Size . . . . .	32
Table 2-3.	Invalid Instructions in 64-Bit Mode . . . . .	34
Table 2-4.	Invalid Instructions in Long Mode . . . . .	35
Table 2-5.	Opcodes Reassigned in 64-Bit Mode . . . . .	36
Table 2-6.	Differences Between Long Mode and Legacy Mode . . . . .	39
Table 4-1.	Segment Registers . . . . .	71
Table 4-2.	Descriptor Types . . . . .	81
Table 4-3.	Code-Segment Descriptor Types . . . . .	83
Table 4-4.	Data-Segment Descriptor Types . . . . .	84
Table 4-5.	System-Segment Descriptor Types (S=0)—Legacy Mode . . . . .	85
Table 4-6.	System-Segment Descriptor Types—Long Mode . . . . .	90
Table 4-7.	Descriptor-Entry Field Changes in Long Mode . . . . .	94
Table 4-8.	Segment Limit Checks in 64-Bit Mode . . . . .	114
Table 5-1.	Supported Paging Alternatives (CR0.PG=1) . . . . .	120
Table 5-2.	Physical-Page Protection, CR0.WP=0 . . . . .	147
Table 5-3.	Effect of CR0.WP=1 on Supervisor Page Access . . . . .	148
Table 6-1.	System Management Instructions . . . . .	149
Table 7-1.	Memory Access by Memory Type . . . . .	173
Table 7-2.	Caching Policy by Memory Type . . . . .	175
Table 7-3.	Memory Access Ordering Rules . . . . .	176
Table 7-4.	AMD64 Architecture Cache-Operating Modes . . . . .	183
Table 7-5.	MTRR Type Field Encodings . . . . .	189
Table 7-6.	Fixed-Range MTRR Address Ranges . . . . .	191
Table 7-7.	Combined MTRR and Page-Level Memory Type with Unmodified PAT MSR . . . . .	197
Table 7-8.	PAT Type Encodings . . . . .	200
Table 7-9.	PAT-Register PA-Field Indexing . . . . .	201
Table 7-10.	Combined Effect of MTRR and PAT Memory Types . . . . .	202
Table 7-11.	Serialization Requirements for Changing Memory Types . . . . .	203
Table 7-12.	Extended Fixed-Range MTRR Type Encodings . . . . .	206
Table 8-1.	Interrupt Vector Source and Cause . . . . .	215
Table 8-2.	Interrupt Vector Classification . . . . .	216

Table 8-3.	Double-Fault Exception Conditions . . . . .	221
Table 8-4.	Invalid-TSS Exception Conditions . . . . .	222
Table 8-5.	Stack Exception Error Codes . . . . .	224
Table 8-6.	General-Protection Exception Conditions . . . . .	225
Table 8-7.	Data-Type Alignment . . . . .	228
Table 8-8.	Simultaneous Interrupt Priorities . . . . .	232
Table 8-9.	Simultaneous Floating-Point Exception Priorities . . . . .	234
Table 8-10.	Virtual-8086 Mode Interrupt Mechanisms . . . . .	245
Table 8-11.	Effect of Instructions that Modify the IF Bit . . . . .	258
Table 9-1.	CPU Watchdog Timer Time Base . . . . .	269
Table 9-2.	CPU Watchdog Timer Count Select . . . . .	269
Table 9-3.	Error Logging Priorities . . . . .	270
Table 9-4.	Error Scope . . . . .	279
Table 10-1.	AMD64 Architecture SMM State-Save Area . . . . .	286
Table 10-2.	Legacy SMM State-Save Area (Not used by AMD64 Architecture) . . . . .	289
Table 10-3.	SMM Register Initialization . . . . .	293
Table 11-1.	SSE Subsets - CPUID Feature Identifiers . . . . .	302
Table 11-2.	Extended Save Area Format . . . . .	316
Table 11-3.	XRSTOR Hardware-Specified Initial Values . . . . .	319
Table 11-4.	Deriving FSAVE Tag Field from FXSAVE Tag Field . . . . .	325
Table 12-1.	Effects of Task Nesting . . . . .	345
Table 13-1.	Breakpoint-Setting Examples . . . . .	356
Table 13-2.	Breakpoint Location by Condition . . . . .	357
Table 13-3.	Host/Guest Only Bits . . . . .	365
Table 13-4.	Count Control Using CNT_MASK and INV . . . . .	366
Table 13-5.	Operating-System Mode and User Mode Bits . . . . .	366
Table 13-6.	EventId Values . . . . .	389
Table 13-7.	Lightweight Profiling CPUID Values . . . . .	400
Table 13-8.	LWPCB—Lightweight Profiling Control Block Fields . . . . .	411
Table 13-9.	LWPCB Filters Fields . . . . .	416
Table 13-10.	XSAVE Area for LWP Fields . . . . .	420
Table 14-1.	Initial Processor State . . . . .	428
Table 14-2.	Initial State of Segment-Register Attributes . . . . .	430
Table 14-3.	x87 Floating-Point State Initialization . . . . .	432
Table 14-4.	Processor Operating Modes . . . . .	436
Table 14-5.	Long-Mode Consistency Checks . . . . .	438

Table 15-1.	Guest Exception or Interrupt Types . . . . .	455
Table 15-2.	EXITINFO1 for MOV CRx . . . . .	457
Table 15-3.	EXITINFO1 for MOV DRx . . . . .	457
Table 15-4.	EXITINFO1 for INTn. . . . .	457
Table 15-5.	EXITINFO1 for INVLPG. . . . .	458
Table 15-6.	Guest Instruction Bytes . . . . .	458
Table 15-7.	Instruction Intercepts. . . . .	459
Table 15-8.	MSR Ranges Covered by MSRPM. . . . .	463
Table 15-9.	TLB Control Byte Encodings . . . . .	474
Table 15-10.	Effect of the GIF on Interrupt Handling . . . . .	475
Table 15-11.	Guest Exception or Interrupt Types . . . . .	477
Table 15-12.	INIT Handling in Different Operating Modes . . . . .	481
Table 15-13.	NMI Handling in Different Operating Modes . . . . .	481
Table 15-14.	SMI Handling in Different Operating Modes. . . . .	482
Table 15-15.	DEV Capability Block, Overall Layout . . . . .	487
Table 15-16.	DEV Capability Header (DEV_HDR) (in PCI Config Space) . . . . .	487
Table 15-17.	Encoding of Function Field in DEV_OP Register . . . . .	488
Table 15-18.	DEV_CR Control Register . . . . .	489
Table 15-19.	Combining Guest and Host PAT Types . . . . .	497
Table 15-20.	Combining PAT and MTRR Types . . . . .	497
Table 15-21.	Guest vAPIC Register Access Behavior. . . . .	507
Table 15-22.	Virtual Interrupt Control (VMCB offset 60h). . . . .	511
Table 15-23.	New VMCB Fields Defined by AVIC . . . . .	511
Table 15-24.	Physical APIC ID Table Entry Fields . . . . .	514
Table 15-25.	Logical APIC ID Table Entry Fields . . . . .	516
Table 15-26.	EXTINFO1 Fields. . . . .	522
Table 15-27.	EXTINFO2 Fields. . . . .	522
Table 15-28.	ID Field—IPI Delivery Failure Cause . . . . .	523
Table 15-29.	EXTINFO1 Fields. . . . .	523
Table 15-30.	EXTINFO2 Fields. . . . .	524
Table 16-1.	Interrupt Sources for Local APIC . . . . .	532
Table 16-2.	APIC Registers . . . . .	535
Table 16-3.	Divide Values . . . . .	541
Table 16-4.	Valid ICR Field Combinations . . . . .	548
Table A-1.	MSRs of the AMD64 Architecture . . . . .	567
Table A-2.	System-Software MSR Cross-Reference . . . . .	571

Table A-3.	Memory-Typing MSR Cross-Reference . . . . .	572
Table A-4.	Machine-Check MSR Cross-Reference . . . . .	574
Table A-5.	Software-Debug MSR Cross-Reference . . . . .	575
Table A-6.	Performance-Monitoring MSR Cross-Reference . . . . .	576
Table A-7.	Secure Virtual Machine MSR Cross-Reference . . . . .	577
Table A-8.	System Management Mode MSR Cross-Reference . . . . .	578
Table A-9.	CPUID Namestring MSRs . . . . .	578
Table B-1.	VMCB Layout, Control Area . . . . .	579
Table B-2.	VMCB Layout, State Save Area . . . . .	583
Table C-1.	SVM Intercept Codes . . . . .	587

## Revision History

Date	Revision	Description
June 2015	3.25	Added new section 15.33 Nested Virtualization for coverage of VMSAVE and VMLOAD and Virtual GIF. Various minor edits.
October 2013	3.24	Added description of Supervisor-Mode Execution Prevention. See Section 5.6.5 "Supervisor-Mode Execution Prevention (CR4.SMEP) Bit" on page 146. Indicated the deprecation of the Processor Feedback Interface. See Section 17.4, "Processor Feedback Interface," on page 565. Added Section 17.5, "Processor Core Power Reporting," on page 565.
May 2013	3.23	Clarified guidelines for implementing cross-modifying code in the sub-section "Cross-Modifying Code" on page 181. Added AVIC description. See Section 15.29, "Advanced Virtual Interrupt Controller," on page 504. Added L2I PMC architecture definition. See Section 13.2, "Performance Monitoring Counters," on page 362.
September 2012	3.22	Clarified processor behavior on write of EFER[LMA] bit in Section 3.1.7 "Extended Feature Enable Register (EFER)" on page 55. Clarified difference between cold reset and warm reset in Section 9.3, "Machine Check Architecture MSRs," on page 265. Added information on FFXSR feature bit to Table 11-1 on page 302. Clarified SMM code responsibility to manage VMCB clean bits. See Section 15.15.2, "Guidelines for Clearing VMCB Clean Bits," on page 471. Added a note to Table 15-9 on page 474 to indicate that all encodings of TLB_CONTROL not defined are reserved. Corrected information concerning the assignment of logical APIC IDs in Section 16.6.1, "Receiving System and IPI Interrupts," on page 549.
March 2012	3.21	Added definition of processor feedback interface—frequency sensitivity monitor (See Section 17.4, "Processor Feedback Interface," on page 565) Added Instruction-Based Sampling in a new section of Chapter 13 (See Section 13.3, "Instruction-Based Sampling," on page 371.) Reworked Introduction and first section of Chapter 9, "Machine Check Architecture," on page 261 and added deferred error handling. Added description of CR4[FSGSBASE] bit. (See Section 3.1.3, "CR4 Register," on page 47.) Added references to the RDFSBASE, RDGSBASE, WRFSBASE, and WRGSBASE instructions in discussion of FS and GS segment descriptors. (See "FS and GS Registers in 64-Bit Mode" on page 72) Added Section 6.3.2, "Accessing Segment Register Hidden State," on page 157.

Date	Revision	Description
December 2011	3.20	<p>Clarified description of the Cache Disable (CD) memory type in Section 7.4 "Memory Types" on page 172.</p> <p>Added caveat: an overflow of either APERF or MPERF can invalidate the effective frequency calculation. See Section 17.3, "Determining Processor Effective Frequency," on page 562.</p> <p>Other minor editorial changes.</p>
September 2011	3.19	<p>Added XSAVEOPT to discussions on XSAVE.</p> <p>Corrections to discussion on multiprocessor memory access ordering in Chapter 7.</p> <p>Added discussion of extended core and northbridge performance counters and feature indicators to Chapter 13.</p> <p>Added Lightweight Profiling (LWP) to Chapter 13.</p> <p>Added Global Timestamp Counter, Continuous Mode to LWP description</p> <p>Clarification: Function of pin A20M# is only defined in real mode. Statement added to Section 1.2.4, "Real Addressing," on page 10.</p> <p>Eliminated hardware P-state references</p>
May 2011	3.18	<p>Added information for OSXSAVE and XSAVE features.</p> <p>Added Cache Topology, Pause Filter Threshold, and XSETBV information.</p> <p>Updated TSC ratio information.</p> <p>Corrected description of FXSAVE/FXRSTOR exception behavior when CR0.EM=1</p>
June 2010	3.17	<p>Replaced missing figures in Chapter 8, "Exceptions and Interrupts," on page 211.</p>
June 2010	3.16	<p>Updated information on performance monitoring counters in "Performance-Monitoring Counter Enable (PCE)" on page 50 and 6.2.5, "Accessing Model-Specific Registers" on page 156.</p> <p>Revised Table 4-1, "Segment Registers" on page 71.</p> <p>Add flush by ASID information to section 15.16, "TLB Control" on page 473.</p> <p>Added information on VMCB clean field to Chapter 15, "Secure Virtual Machine" on page 445 and Appendix B, "Layout of VMCB" on page 579.</p> <p>Added section 15.10, "IOIO Intercepts" on page 461.</p> <p>Added section 15.30.5, "TSC Ratio MSR (C000_0104h)" on page 526.</p> <p>Added section 17.2, "Core Performance Boost" on page 561.</p>

Date	Revision	Description
November 2009	3.15	<p>Added section 7.5, "Buffering and Combining Memory Writes" on page 177</p> <p>Added MFENCE to list of "Serializing Instructions" on page 185.</p> <p>Updated section 7.6.1, "Cache Organization and Operation" on page 179.</p> <p>Updated Table 7-3, "Memory Access Ordering Rules", on page 176 and notes.</p> <p>Updated 7.4, "Memory Types" on page 172.</p> <p>Clarified 5.5.2, "TLB Management" on page 142.</p> <p>Added "Invalidation of Table Entry Upgrades." on page 143.</p> <p>Updated "Speculative Caching of Address Translations" on page 143.</p> <p>Update "Handling of D-Bit Updates" on page 144.</p> <p>Revised and updated section 7.2, "Multiprocessor Memory Access Ordering" on page 166 ff.</p> <p>Added information on long mode segment-limit checks in "Extended Feature Enable Register (EFER)" on page 56table on page 56 and "Long Mode Segment Limit Enable (LMSLE) bit" on page 57 on page 57.</p> <p>Added discussion of "Data Limit Checks in 64-bit Mode" on page 114on page 114.</p> <p>Updated Table 6-1, "System Management Instructions", on page 149.</p> <p>Updated "Canonicalization and Consistency Checks" on page 451on page 451.</p> <p>Added information about the next sequential instruction pointer (nRIP) in 15.7.1, "State Saved on Exit" on page 454.</p> <p>Updated priority definition of PAUSE instruction intercept in Table 15-7, "Instruction Intercepts", on page 459.</p> <p>Added nRIP field to Table B-1, "VMCB Layout, Control Area", on page 579.</p> <p>Clarified information on ICEBP event injection, on page 476.</p> <p>Deleted erroneous statement concerning the operation of the General Local Vector Table register Mask bit in section 16.4.</p> <p>Clarified the description of the Interrupt Command Register Delivery Status bit in section "Interprocessor Interrupts (IPI)" on page 545on page 545.</p>
September 2007	3.14	<p>Added information on "Speculative Caching of Address Translations," "Caching of Upper Level Translation Table Entries," "Use of Cached Entries When Reporting a Page Fault Exception," "Use of Cached Entries When Reporting a Page Fault Exception," "Handling of D-Bit Updates," "Invalidation of Cached Upper-level Entries by INVLPG" on page 144 and "Handling of PDPT Entries in PAE Mode" on page 144to section 5.5.2, "TLB Management" on page 142.</p> <p>Added 15.21.7, "Interrupt Masking in Local APIC" on page 480.</p> <p>Added 16.3.6, "Extended APIC Control Register" on page 537; clarified the use of the ICR DS bit in 16.5, "Interprocessor Interrupts (IPI)" on page 545.</p> <p>Added minor clarifications and corrected typographical and formatting errors.</p>

Date	Revision	Description
July 2007	3.13	<p>Added 5.3.5, "1-Gbyte Page Translation" on page 135.</p> <p>Added 7.2, "Multiprocessor Memory Access Ordering" on page 166</p> <p>Added divide-by-zero exception to Table 8-8, "Simultaneous Interrupt Priorities", on page 232.</p> <p>Added information on "CPU Watchdog Timer Register" on page 268 and "Machine-Check Miscellaneous-Error Information Register 0(MCi_MISC0)" on page 274 to Chapter 9.</p> <p>Added SSE4A support to Chapter 11, "SSE, MMX, and x87 Programming" on page 301.</p> <p>Added Monitor and MWAIT intercept information to section 15.9, "Instruction Intercepts" on page 459 and reorganized intercept information; clarified 15.16.1, "TLB Flush" on page 473.</p> <p>Added Monitor and MWAIT intercepts to tables B-1, "VMCB Layout, Control Area" on page 579 and C-1, "SVM Intercept Codes" on page 587.</p> <p>Added Chapter 16, "Advanced Programmable Interrupt Controller (APIC)" on page 531, Chapter 17, "OS-Visible Workaround Information" on page 515, Chapter 17, "Hardware Performance Monitoring and Control" on page 559.</p> <p>Added Table A-7, "Secure Virtual Machine MSR Cross-Reference", on page 577.</p> <p>Added minor clarifications and corrected typographical and formatting errors.</p>
September 2006	3.12	Added numerous minor clarifications.
December 2005	3.11	Added Chapter 15, Secure Virtual Machine. Incorporated numerous factual corrections and updates.
February 2005	3.10	<p>Corrected Table 8-6, "General-Protection Exception Conditions", on page 225.</p> <p>Added SSE3 information. Clarified and corrected information on the CPUID instruction and feature identification. Added information on the RDTSCP instruction. Clarified information about MTRRs and PATs in multiprocessing systems.</p>
September 2003	3.09	Corrected numerous minor typographical errors.
April 2003	3.08	<p>Clarified terms in section on FXSAVE/FXSTOR. Corrected several minor errors of omission. Documentation of CR0.NW bit has been corrected. Several register diagrams and figure labels have been corrected. Description of shared cache lines has been clarified in 7.3, "Memory Coherency and Protocol" on page 169.</p>
September 2002	3.07	Made numerous small grammatical changes and factual clarifications. Added Revision History.



## Preface

---

### About This Book

This book is part of a multivolume work entitled the *AMD64 Architecture Programmer's Manual*. This table lists each volume and its order number. This instruction is intended for use mainly with shadow page tables, but it can be used with nested page tables as well. In either case, the address operand is treated as a guest linear address for the TLB lookup.

Title	Order No.
<i>Volume 1: Application Programming</i>	24592
<i>Volume 2: System Programming</i>	24593
<i>Volume 3: General-Purpose and System Instructions</i>	24594
<i>Volume 4: 128-Bit and 256-Bit Media Instructions</i>	26568
<i>Volume 5: 64-Bit Media and x87 Floating-Point Instructions</i>	26569

### Audience

This volume (Volume 2) is intended for programmers writing operating systems, loaders, linkers, device drivers, or system utilities. It assumes an understanding of AMD64 architecture application-level programming as described in Volume 1.

This volume describes the AMD64 architecture's resources and functions that are managed by system software, including operating-mode control, memory management, interrupts and exceptions, task and state-change management, system-management mode (including power management), multi-processor support, debugging, and processor initialization.

Application-programming topics are described in Volume 1. Details about each instruction are described in Volumes 3, 4, and 5.

### Organization

This volume begins with an overview of system programming and differences between the x86 and AMD64 architectures. This is followed by chapters that describe the following details of system programming:

- *System Resources*—The system registers and processor ID (CPUID) functions.
- *Segmented Virtual Memory*—The segmented-memory models supported by the architecture and their associated data structures and protection checks.

- *Page Translation and Protection*—The page-translation functions supported by the architecture and their associated data structures and protection checks.
- *System-Management Instructions*—The instructions used to manage system functions.
- *Memory System*—The memory-system hierarchy and its resources and protocols, including memory-characterization, caching, and buffering functions.
- *Exceptions and Interrupts*—Details about the types and causes of exceptions and interrupts, and the methods of transferring control during these events.
- *Machine-Check Mechanism*—The resources and functions that support detection and handling of machine-check errors.
- *System-Management Mode*—The resources and functions that support system-management mode (SMM), including power-management functions.
- *SSE, MMX, and x87 Programming*—The resources and functions that support use (by application software) and state-saving (by the operation system) of the 256-bit media, 128-bit media, 64-bit media, and x87 floating-point instructions.
- *Multiple-Processor Management*—The features of the instruction set and the system resources and functions that support multiprocessing environments.
- *Debug and Performance Resources*—The system resources and functions that support software debugging and performance monitoring.
- *Legacy Task Management*—Support for the legacy hardware multitasking functions, including register resources and data structures.
- *Processor Initialization and Long-Mode Activation*—The methods by which system software initializes and changes operating modes.
- *Mixing Code Across Operating Modes*—Things to remember when running programs in different operating modes.
- *Secure Virtual Machine*—The system resources that support virtualization development and deployment.

There are appendices describing details of model-specific registers (MSRs) and machine-check implementations. Definitions assumed throughout this volume are listed below. The index at the end of this volume cross-references topics within the volume. For other topics relating to the AMD64 architecture, see the tables of contents and indexes of the other volumes.

## Conventions and Definitions

The section which follows, **Notational Conventions**, describes notational conventions used in this volume. The next section, **Definitions**, lists a number of terms used in this volume along with their technical definitions. Some of these definitions assume knowledge of the legacy x86 architecture. See “Related Documents” on page xlv for further information about the legacy x86 architecture. Finally, the **Registers** section lists the registers which are a part of the system programming model.

## Notational Conventions

#GP(0)

An instruction exception—in this example, a general-protection exception with error code of 0.

1011b

A binary value—in this example, a 4-bit value.

F0EA\_0B02h

A hexadecimal value. Underscore characters may be inserted to improve readability.

128

Numbers without an alpha suffix are decimal unless the context indicates otherwise.

7:4

A bit range, from bit 7 to 4, inclusive. The high-order bit is shown first. Commas may be inserted to indicate gaps.

CPUID FnXXXX\_XXXX\_RRR[*FieldName*]

Support for optional features or the value of an implementation-specific parameter of a processor can be discovered by executing the CPUID instruction on that processor. To obtain this value, software must execute the CPUID instruction with the function code XXXX\_XXXXh in EAX and then examine the field *FieldName* returned in register *RRR*. If the “\_RRR” notation is followed by “\_xYYY”, register ECX must be set to the value YYYh before executing CPUID. When *FieldName* is not given, the entire contents of register *RRR* contains the desired value. When determining optional feature support, if the bit identified by *FieldName* is set to a one, the feature is supported on that processor.

CR0–CR4

A register range, from register CR0 through CR4, inclusive, with the low-order register first.

CR0[PE]

Notation for referring to a field within a register—in this case, the PE field of the CR0 register.

CR0[PE] = 1

The PE field of the CR0 register is set (contains the value 1).

EFER[LME] = 0

The LME field of the EFER register is cleared (contains a value of 0).

DS:SI

A far pointer or logical address. The real address or segment descriptor specified by the segment register (DS in this example) is combined with the offset contained in the second register (SI in this example) to form a real or virtual address.

## RFLAGS[13:12]

A field within a register identified by its bit range. In this example, corresponding to the IOPL field.

**Definitions**

## 16-bit mode

Legacy mode or compatibility mode in which a 16-bit address size is active. See *legacy mode* and *compatibility mode*.

## 32-bit mode

Legacy mode or compatibility mode in which a 32-bit address size is active. See *legacy mode* and *compatibility mode*.

## 64-bit mode

A submode of *long mode*. In 64-bit mode, the default address size is 64 bits and new features, such as register extensions, are supported for system and application software.

## absolute

Said of a displacement that references the base of a code segment rather than an instruction pointer. Contrast with *relative*.

## ASID

Address space identifier.

## byte

Eight bits.

## clear

To write a bit value of 0. Compare *set*.

## compatibility mode

A submode of *long mode*. In compatibility mode, the default address size is 32 bits, and legacy 16-bit and 32-bit applications run without modification.

## commit

To irreversibly write, in program order, an instruction's result to software-visible storage, such as a register (including flags), the data cache, an internal write buffer, or memory.

## CPL

Current privilege level.

## direct

Referencing a memory location whose address is included in the instruction's syntax as an immediate operand. The address may be an absolute or relative address. Compare *indirect*.

**dirty data**

Data held in the processor's caches or internal buffers that is more recent than the copy held in main memory.

**displacement**

A signed value that is added to the base of a segment (absolute addressing) or an instruction pointer (relative addressing). Same as *offset*.

**doubleword**

Two words, or four bytes, or 32 bits.

**double quadword**

Eight words, or 16 bytes, or 128 bits. Also called *octword*.

**effective address size**

The address size for the current instruction after accounting for the default address size and any address-size override prefix.

**effective operand size**

The operand size for the current instruction after accounting for the default operand size and any operand-size override prefix.

**exception**

An abnormal condition that occurs as the result of executing an instruction. The processor's response to an exception depends on the type of the exception. For all exceptions except 128-bit media SIMD floating-point exceptions and x87 floating-point exceptions, control is transferred to the handler (or service routine) for that exception, as defined by the exception's vector. For floating-point exceptions defined by the IEEE 754 standard, there are both masked and unmasked responses. When unmasked, the exception handler is called, and when masked, a default response is provided instead of calling the handler.

**flush**

An often ambiguous term meaning (1) writeback, if modified, and invalidate, as in "flush the cache line," or (2) invalidate, as in "flush the pipeline," or (3) change a value, as in "flush to zero."

**GDT**

Global descriptor table.

**GIF**

Global interrupt flag.

**GPA**

Guest physical address. In a virtualized environment, the page tables maintained by the guest operating system provide the translation from the linear (virtual) address to the guest physical

address. Nested page tables define the translation of the GPA to the host physical address (HPA). See *SPA* and *HPA*.

#### HPA

Host physical address. The address space owned by the virtual machine monitor. In a virtualized environment, nested page translation tables controlled by the VMM provide the translation from the guest physical address to the host physical address. See *GPA*.

#### IDT

Interrupt descriptor table.

#### IGN

Ignored. Value written is ignored by hardware. Value returned on a read is indeterminate. See *reserved*.

#### indirect

Referencing a memory location whose address is in a register or other memory location. The address may be an absolute or relative address. Compare *direct*.

#### IRB

The virtual-8086 mode interrupt-redirection bitmap.

#### IST

The long-mode interrupt-stack table.

#### IVT

The real-address mode interrupt vector table.

#### LDT

Local descriptor table.

#### legacy x86

The legacy x86 architecture. See “Related Documents” on page xlv for descriptions of the legacy x86 architecture.

#### legacy mode

An operating mode of the AMD64 architecture in which existing 16-bit and 32-bit applications and operating systems run without modification. A processor implementation of the AMD64 architecture can run in either *long mode* or *legacy mode*. Legacy mode has three submodes, *real mode*, *protected mode*, and *virtual-8086 mode*.

#### long mode

An operating mode unique to the AMD64 architecture. A processor implementation of the AMD64 architecture can run in either *long mode* or *legacy mode*. Long mode has two submodes, *64-bit mode* and *compatibility mode*.

lsb

Least-significant bit.

LSB

Least-significant byte.

main memory

Physical memory, such as RAM and ROM (but not cache memory) that is installed in a particular computer system.

mask

(1) A control bit that prevents the occurrence of a floating-point exception from invoking an exception-handling routine. (2) A field of bits used for a control purpose.

MBZ

Must be zero. If software attempts to set an MBZ bit to 1, a general-protection exception (#GP) occurs. See *reserved*.

memory

Unless otherwise specified, *main memory*.

ModRM

A byte following an instruction opcode that specifies address calculation based on mode (Mod), register (R), and memory (M) variables.

moffset

A 16, 32, or 64-bit offset that specifies a memory operand directly, without using a ModRM or SIB byte.

msb

Most-significant bit.

MSB

Most-significant byte.

octword

Same as *double quadword*.

offset

Same as *displacement*.

overflow

The condition in which a floating-point number is larger in magnitude than the largest, finite, positive or negative number that can be represented in the data-type format being used.

## PAE

Physical-address extensions.

## physical memory

Actual memory, consisting of *main memory* and cache.

## probe

A check for an address in a processor's caches or internal buffers. *External probes* originate outside the processor, and *internal probes* originate within the processor.

## protected mode

A submode of *legacy mode*.

## quadword

Four words, or eight bytes, or 64 bits.

## RAZ

Value returned on a read is always zero (0) regardless of what was previously written. See *reserved*.

## real-address mode

See *real mode*.

## real mode

A short name for *real-address mode*, a submode of *legacy mode*.

## relative

Referencing with a displacement (also called offset) from an instruction pointer rather than the base of a code segment. Contrast with *absolute*.

## reserved

Fields marked as reserved may be used at some future time.

To preserve compatibility with future processors, reserved fields require special handling when read or written by software. Software must not depend on the state of a reserved field (unless qualified as RAZ), nor upon the ability of such fields to return a previously written state.

If a field is marked reserved without qualification, software must not change the state of that field; it must reload that field with the same value returned from a prior read.

Reserved fields may be qualified as IGN, MBZ, RAZ, or SBZ (see definitions).

## REX

An instruction prefix that specifies a 64-bit operand size and provides access to additional registers.

## RIP-relative addressing

Addressing relative to the 64-bit RIP instruction pointer.



**SBZ**

Should be zero. An attempt by software to set an SBZ bit to 1 results in undefined behavior. See *reserved*.

**set**

To write a bit value of 1. Compare *clear*.

**SIB**

A byte following an instruction opcode that specifies address calculation based on scale (S), index (I), and base (B).

**SPA**

System physical address. The address directly used to address system memory. Under SVM, also known as the host physical address. See *HPA*.

**sticky bit**

A bit that is set or cleared by hardware and that remains in that state until explicitly changed by software.

**SVM**

Secure virtual machine. AMD's virtualization architecture. SVM is defined in Chapter 15 on page 445.

**System software**

Privileged software that owns and manages the hardware resources of a system after initialization by *system firmware* and controls access to these resources. In a non-virtualized environment, system software is provided by the operating system. In a virtualized environment, system software is largely equivalent to the virtual machine monitor (VMM), also commonly known as the *hypervisor*.

**TOP**

The x87 top-of-stack pointer.

**TSS**

Task-state segment.

**underflow**

The condition in which a floating-point number is smaller in magnitude than the smallest nonzero, positive or negative number that can be represented in the data-type format being used.

**vector**

(1) A set of integer or floating-point values, called *elements*, that are packed into a single data object. Most of the SSE and 64-bit media instructions use vectors as operands.

(2) An index into an interrupt descriptor table (IDT), used to access exception handlers. Compare *exception*.

virtual-8086 mode

A submode of *legacy mode*.

VMCB

Virtual machine control block.

VMM

Virtual machine monitor.

word

Two bytes, or 16 bits.

x86

See *legacy x86*.

## Registers

In the following list of registers, the names are used to refer either to a given register or to the contents of that register:

AH–DH

The high 8-bit AH, BH, CH, and DH registers. Compare *AL–DL*.

AL–DL

The low 8-bit AL, BL, CL, and DL registers. Compare *AH–DH*.

AL–r15B

The low 8-bit AL, BL, CL, DL, SIL, DIL, BPL, SPL, and R8B–R15B registers, available in 64-bit mode.

BP

Base pointer register.

CR<sub>*n*</sub>

Control register number *n*.

CS

Code segment register.

eAX–eSP

The 16-bit AX, BX, CX, DX, DI, SI, BP, and SP registers or the 32-bit EAX, EBX, ECX, EDX, EDI, ESI, EBP, and ESP registers. Compare *rAX–rSP*.

EFER

Extended features enable register.

**eFLAGS**

16-bit or 32-bit flags register. Compare *rFLAGS*.

**EFLAGS**

32-bit (extended) flags register.

**eIP**

16-bit or 32-bit instruction-pointer register. Compare *rIP*.

**EIP**

32-bit (extended) instruction-pointer register.

**FLAGS**

16-bit flags register.

**GDTR**

Global descriptor table register.

**GPRs**

General-purpose registers. For the 16-bit data size, these are AX, BX, CX, DX, DI, SI, BP, and SP. For the 32-bit data size, these are EAX, EBX, ECX, EDX, EDI, ESI, EBP, and ESP. For the 64-bit data size, these include RAX, RBX, RCX, RDX, RDI, RSI, RBP, RSP, and R8–R15.

**IDTR**

Interrupt descriptor table register.

**IP**

16-bit instruction-pointer register.

**LDTR**

Local descriptor table register.

**MSR**

Model-specific register.

**r8–r15**

The 8-bit R8B–R15B registers, or the 16-bit R8W–R15W registers, or the 32-bit R8D–R15D registers, or the 64-bit R8–R15 registers.

**rAX–rSP**

The 16-bit AX, BX, CX, DX, DI, SI, BP, and SP registers, or the 32-bit EAX, EBX, ECX, EDX, EDI, ESI, EBP, and ESP registers, or the 64-bit RAX, RBX, RCX, RDX, RDI, RSI, RBP, and RSP registers. Replace the placeholder *r* with nothing for 16-bit size, “E” for 32-bit size, or “R” for 64-bit size.

**RAX**

64-bit version of the EAX register.

**RBP**

64-bit version of the EBP register.

**RBX**

64-bit version of the EBX register.

**RCX**

64-bit version of the ECX register.

**RDI**

64-bit version of the EDI register.

**RDX**

64-bit version of the EDX register.

**rFLAGS**

16-bit, 32-bit, or 64-bit flags register. Compare *RFLAGS*.

**RFLAGS**

64-bit flags register. Compare *rFLAGS*.

**rIP**

16-bit, 32-bit, or 64-bit instruction-pointer register. Compare *RIP*.

**RIP**

64-bit instruction-pointer register.

**RSI**

64-bit version of the ESI register.

**RSP**

64-bit version of the ESP register.

**SP**

Stack pointer register.

**SS**

Stack segment register.

**TPR**

Task priority register (CR8), a new register introduced in the AMD64 architecture to speed interrupt management.

TR

Task register.

YMM/XMM

Set of sixteen (eight accessible in legacy and compatibility modes) 256-bit wide registers that hold scalar and vector operands used by the SSE instructions.

## Endian Order

The x86 and AMD64 architectures address memory using little-endian byte-ordering. Multibyte values are stored with their least-significant byte at the lowest byte address, and they are illustrated with their least significant byte at the right side. Strings are illustrated in reverse order, because the addresses of their bytes increase from right to left.

## Related Documents

- Peter Abel, *IBM PC Assembly Language and Programming*, Prentice-Hall, Englewood Cliffs, NJ, 1995.
- Rakesh Agarwal, *80x86 Architecture & Programming: Volume II*, Prentice-Hall, Englewood Cliffs, NJ, 1991.
- AMD, *BIOS and Kernel Developer's Guide* for particular hardware implementations of the AMD64 architecture.
- AMD, *AMD I/O Virtualization Technology (IOMMU) Specification*, Revision 2.2 or later; order number 48882.
- AMD, *Software Optimization Guide for AMD Family 15h Processors*, order number 47414.
- Don Anderson and Tom Shanley, *Pentium Processor System Architecture*, Addison-Wesley, New York, 1995.
- Nabajyoti Barkakati and Randall Hyde, *Microsoft Macro Assembler Bible*, Sams, Carmel, Indiana, 1992.
- Barry B. Brey, *8086/8088, 80286, 80386, and 80486 Assembly Language Programming*, Macmillan Publishing Co., New York, 1994.
- Barry B. Brey, *Programming the 80286, 80386, 80486, and Pentium Based Personal Computer*, Prentice-Hall, Englewood Cliffs, NJ, 1995.
- Ralf Brown and Jim Kyle, *PC Interrupts*, Addison-Wesley, New York, 1994.
- Penn Brumm and Don Brumm, *80386/80486 Assembly Language Programming*, Windcrest McGraw-Hill, 1993.
- Geoff Chappell, *DOS Internals*, Addison-Wesley, New York, 1994.
- Chips and Technologies, Inc. *Super386 DX Programmer's Reference Manual*, Chips and Technologies, Inc., San Jose, 1992.
- John Crawford and Patrick Gelsinger, *Programming the 80386*, Sybex, San Francisco, 1987.

- Cyrix Corporation, *5x86 Processor BIOS Writer's Guide*, Cyrix Corporation, Richardson, TX, 1995.
- Cyrix Corporation, *M1 Processor Data Book*, Cyrix Corporation, Richardson, TX, 1996.
- Cyrix Corporation, *MX Processor MMX Extension Opcode Table*, Cyrix Corporation, Richardson, TX, 1996.
- Cyrix Corporation, *MX Processor Data Book*, Cyrix Corporation, Richardson, TX, 1997.
- Ray Duncan, *Extending DOS: A Programmer's Guide to Protected-Mode DOS*, Addison Wesley, NY, 1991.
- William B. Giles, *Assembly Language Programming for the Intel 80xxx Family*, Macmillan, New York, 1991.
- Frank van Gilluwe, *The Undocumented PC*, Addison-Wesley, New York, 1994.
- John L. Hennessy and David A. Patterson, *Computer Architecture*, Morgan Kaufmann Publishers, San Mateo, CA, 1996.
- Thom Hogan, *The Programmer's PC Sourcebook*, Microsoft Press, Redmond, WA, 1991.
- Hal Katircioglu, *Inside the 486, Pentium, and Pentium Pro*, Peer-to-Peer Communications, Menlo Park, CA, 1997.
- IBM Corporation, *486SLC Microprocessor Data Sheet*, IBM Corporation, Essex Junction, VT, 1993.
- IBM Corporation, *486SLC2 Microprocessor Data Sheet*, IBM Corporation, Essex Junction, VT, 1993.
- IBM Corporation, *80486DX2 Processor Floating Point Instructions*, IBM Corporation, Essex Junction, VT, 1995.
- IBM Corporation, *80486DX2 Processor BIOS Writer's Guide*, IBM Corporation, Essex Junction, VT, 1995.
- IBM Corporation, *Blue Lightning 486DX2 Data Book*, IBM Corporation, Essex Junction, VT, 1994.
- Institute of Electrical and Electronics Engineers, *IEEE Standard for Binary Floating-Point Arithmetic*, ANSI/IEEE Std 754-1985.
- Institute of Electrical and Electronics Engineers, *IEEE Standard for Radix-Independent Floating-Point Arithmetic*, ANSI/IEEE Std 854-1987.
- Muhammad Ali Mazidi and Janice Gillispie Mazidi, *80X86 IBM PC and Compatible Computers*, Prentice-Hall, Englewood Cliffs, NJ, 1997.
- Hans-Peter Messmer, *The Indispensable Pentium Book*, Addison-Wesley, New York, 1995.
- Karen Miller, *An Assembly Language Introduction to Computer Architecture: Using the Intel Pentium*, Oxford University Press, New York, 1999.
- Stephen Morse, Eric Isaacson, and Douglas Albert, *The 80386/387 Architecture*, John Wiley & Sons, New York, 1987.
- NexGen Inc., *Nx586<sup>TM</sup> Processor Data Book*, NexGen Inc., Milpitas, CA, 1993.

- NexGen Inc., *Nx686<sup>TM</sup> Processor Data Book*, NexGen Inc., Milpitas, CA, 1994.
- Bipin Patwardhan, *Introduction to the Streaming SIMD Extensions in the Pentium® III*, [www.x86.org/articles/sse\\_pt1/simd1.htm](http://www.x86.org/articles/sse_pt1/simd1.htm), June, 2000.
- Peter Norton, Peter Aitken, and Richard Wilton, *PC Programmer's Bible*, Microsoft Press, Redmond, WA, 1993.
- *PharLap 386/ASM Reference Manual*, Pharlap, Cambridge MA, 1993.
- *PharLap TNT DOS-Extender Reference Manual*, Pharlap, Cambridge MA, 1995.
- Sen-Cuo Ro and Sheau-Chuen Her, *i386/i486 Advanced Programming*, Van Nostrand Reinhold, New York, 1993.
- Jeffrey P. Royer, *Introduction to Protected Mode Programming*, course materials for an onsite class, 1992.
- Tom Shanley, *Protected Mode System Architecture*, Addison Wesley, NY, 1996.
- SGS-Thomson Corporation, *80486DX Processor SMM Programming Manual*, SGS-Thomson Corporation, 1995.
- Walter A. Triebel, *The 80386DX Microprocessor*, Prentice-Hall, Englewood Cliffs, NJ, 1992.
- John Wharton, *The Complete x86*, MicroDesign Resources, Sebastopol, California, 1994.
- Web sites and newsgroups:
  - [www.amd.com](http://www.amd.com)
  - [news.comp.arch](http://news.comp.arch)
  - [news.comp.lang.asm.x86](http://news.comp.lang.asm.x86)
  - [news.intel.microprocessors](http://news.intel.microprocessors)
  - [news.microsoft](http://news.microsoft)





---

# 1 System-Programming Overview

---

This entire volume is intended for system-software developers—programmers writing operating systems, loaders, linkers, device drivers, or utilities that require access to system resources. These system resources are generally available only to software running at the highest-privilege level (CPL=0), also referred to as *privileged software*. Privilege levels and their interactions are fully described in “Segment-Protection Overview” on page 95.

This chapter introduces the basic features and capabilities of the AMD64 architecture that are available to system-software developers. The concepts include:

- The supported address forms and how memory is organized.
- How memory-management hardware makes use of the various address forms to access memory.
- The processor operating modes, and how the memory-management hardware supports each of those modes.
- The system-control registers used to manage system resources.
- The interrupt and exception mechanism, and how it is used to interrupt program execution and to report errors.
- Additional, miscellaneous features available to system software, including support for hardware multitasking, reporting machine-check exceptions, debugging software problems, and optimizing software performance.

Many of the legacy features and capabilities are enhanced by the AMD64 architecture to support 64-bit operating systems and applications, while providing backward-compatibility with existing software.

## 1.1 Memory Model

The AMD64 architecture memory model is designed to allow system software to manage application software and associated data in a secure fashion. The memory model is backward-compatible with the legacy memory model. Hardware-translation mechanisms are provided to map addresses between virtual-memory space and physical-memory space. The translation mechanisms allow system software to relocate applications and data transparently, either anywhere in physical-memory space, or in areas on the system hard drive managed by the operating system.

In long mode, the AMD64 architecture implements a flat-memory model. In legacy mode, the architecture implements all legacy memory models.

### 1.1.1 Memory Addressing

The AMD64 architecture supports address relocation. To do this, several types of addresses are needed to completely describe memory organization. Specifically, four types of addresses are defined by the AMD64 architecture:

- Logical addresses
- Effective addresses, or segment offsets, which are a portion of the logical address.
- Linear (virtual) addresses
- Physical addresses

**Logical Addresses.** A *logical address* is a reference into a segmented-address space. It is comprised of the segment selector and the effective address. Notationally, a logical address is represented as

Logical Address = Segment Selector : Offset

The segment selector specifies an entry in either the global or local descriptor table. The specified descriptor-table entry describes the segment location in virtual-address space, its size, and other characteristics. The effective address is used as an offset into the segment specified by the selector.

Logical addresses are often referred to as *far pointers*. Far pointers are used in software addressing when the segment reference must be explicit (i.e., a reference to a segment outside the current segment).

**Effective Addresses.** The offset into a memory segment is referred to as an effective address (see “Segmentation” on page 5 for a description of segmented memory). Effective addresses are formed by adding together elements comprising a base value, a scaled-index value, and a displacement value. The effective-address computation is represented by the equation

Effective Address = Base + (Scale × Index) + Displacement

The elements of an effective-address computation are defined as follows:

- *Base*—A value stored in any general-purpose register.
- *Scale*—A positive value of 1, 2, 4, or 8.
- *Index*—A two’s-complement value stored in any general-purpose register.
- *Displacement*—An 8-bit, 16-bit, or 32-bit two’s-complement value encoded as part of the instruction.

Effective addresses are often referred to as *near pointers*. A near pointer is used when the segment selector is known implicitly or when the flat-memory model is used.

Long mode defines a 64-bit effective-address length. If a processor implementation does not support the full 64-bit virtual-address space, the effective address must be in *canonical form* (see “Canonical Address Form” on page 4).

**Linear (Virtual) Addresses.** The segment-selector portion of a logical address specifies a segment-descriptor entry in either the global or local descriptor table. The specified segment-descriptor entry contains the segment-base address, which is the starting location of the segment in linear-address space. A *linear address* is formed by adding the segment-base address to the effective address (segment offset), which creates a reference to any byte location within the supported linear-address space. Linear addresses are often referred to as *virtual addresses*, and both terms are used interchangeably throughout this document.

Linear Address = Segment Base Address + Effective Address

When the flat-memory model is used—as in 64-bit mode—a segment-base address is treated as 0. In this case, the linear address is identical to the effective address. In long mode, linear addresses must be in canonical address form, as described in “Canonical Address Form” on page 4.

**Physical Addresses.** A *physical address* is a reference into the physical-address space, typically main memory. Physical addresses are translated from virtual addresses using page-translation mechanisms. See “Paging” on page 7 for information on how the paging mechanism is used for virtual-address to physical-address translation. When the paging mechanism is not enabled, the virtual (linear) address is used as the physical address.

### 1.1.2 Memory Organization

The AMD64 architecture organizes memory into *virtual memory* and *physical memory*. Virtual-memory and physical-memory spaces can be (and usually are) different in size. Generally, the virtual-address space is much larger than physical-address memory. System software relocates applications and data between physical memory and the system hard disk to make it appear that much more memory is available than really exists. System software then uses the hardware memory-management mechanisms to map the larger virtual-address space into the smaller physical-address space.

**Virtual Memory.** Software uses virtual addresses to access locations within the virtual-memory space. System software is responsible for managing the relocation of applications and data in virtual-memory space using segment-memory management. System software is also responsible for mapping virtual memory to physical memory through the use of page translation. The AMD64 architecture supports different virtual-memory sizes using the following address-translation modes:

- *Protected Mode*—This mode supports 4 gigabytes of virtual-address space using 32-bit virtual addresses.
- *Long Mode*—This mode supports 16 exabytes of virtual-address space using 64-bit virtual addresses.

**Physical Memory.** Physical addresses are used to directly access main memory. For a particular computer system, the size of the *available* physical-address space is equal to the amount of main memory installed in the system. The maximum amount of physical memory accessible depends on the processor implementation and on the address-translation mode. The AMD64 architecture supports varying physical-memory sizes using the following address-translation modes:

- *Real-Address Mode*—This mode, also called *real mode*, supports 1 megabyte of physical-address space using 20-bit physical addresses. This address-translation mode is described in “Real Addressing” on page 10. Real mode is available only from legacy mode (see “Legacy Modes” on page 14).

- *Legacy Protected Mode*—This mode supports several different address-space sizes, depending on the translation mechanism used and whether extensions to those mechanisms are enabled.

Legacy protected mode supports 4 gigabytes of physical-address space using 32-bit physical addresses. Both segment translation (see “Segmentation” on page 5) and page translation (see “Paging” on page 7) can be used to access the physical address space, when the processor is running in legacy protected mode.

When the physical-address size extensions are enabled (see “Physical-Address Extensions (PAE) Bit” on page 121), the page-translation mechanism can be extended to support 52-bit physical addresses. 52-bit physical addresses allow up to 4 petabytes of physical-address space to be supported. (Currently, the AMD64 architecture supports 40-bit addresses in this mode, allowing up to 1 terabyte of physical-address space to be supported.)

- *Long Mode*—This mode is unique to the AMD64 architecture. This mode supports up to 4 petabytes of physical-address space using 52-bit physical addresses. Long mode requires the use of page-translation and the physical-address size extensions (PAE).

### 1.1.3 Canonical Address Form

Long mode defines 64 bits of virtual-address space, but processor implementations can support less. Although some processor implementations do not use all 64 bits of the virtual address, they all check bits 63 through the most-significant implemented bit to see if those bits are all zeros or all ones. An address that complies with this property is in *canonical address form*. In most cases, a virtual-memory reference that is not in canonical form causes a general-protection exception (#GP) to occur. However, implied stack references where the stack address is not in canonical form causes a stack exception (#SS) to occur. Implied stack references include all push and pop instructions, and any instruction using RSP or RBP as a base register.

By checking canonical-address form, the AMD64 architecture prevents software from exploiting unused high bits of pointers for other purposes. Software complying with canonical-address form on a specific processor implementation can run unchanged on long-mode implementations supporting larger virtual-address spaces.

## 1.2 Memory Management

Memory management consists of the methods by which addresses generated by software are translated by segmentation and/or paging into addresses in physical memory. Memory management is not visible to application software. It is handled by the system software and processor hardware.

### 1.2.1 Segmentation

Segmentation was originally created as a method by which system software could isolate software processes (tasks), and the data used by those processes, from one another in an effort to increase the reliability of systems running multiple processes simultaneously.

The AMD64 architecture is designed to support all forms of legacy segmentation. However, most modern system software does not use the segmentation features available in the legacy x86 architecture. Instead, system software typically handles program and data isolation using page-level protection. For this reason, the AMD64 architecture dispenses with multiple segments in 64-bit mode and, instead, uses a flat-memory model. The elimination of segmentation allows new 64-bit system software to be coded more simply, and it supports more efficient management of multi-processing than is possible in the legacy x86 architecture.

Segmentation is, however, used in compatibility mode and legacy mode. Here, segmentation is a form of base memory-addressing that allows software and data to be relocated in virtual-address space off of an arbitrary base address. Software and data can be relocated in virtual-address space using one or more variable-sized *memory segments*. The legacy x86 architecture provides several methods of restricting access to segments from other segments so that software and data can be protected from interfering with each other.

In compatibility and legacy modes, up to 16,383 unique segments can be defined. The base-address value, segment size (called a *limit*), protection, and other attributes for each segment are contained in a data structure called a *segment descriptor*. Collections of segment descriptors are held in *descriptor tables*. Specific segment descriptors are referenced or selected from the descriptor table using a *segment selector register*. Six segment-selector registers are available, providing access to as many as six segments at a time.

Figure 1-1 on page 6 shows an example of segmented memory. Segmentation is described in Chapter 4, “Segmented Virtual Memory.”

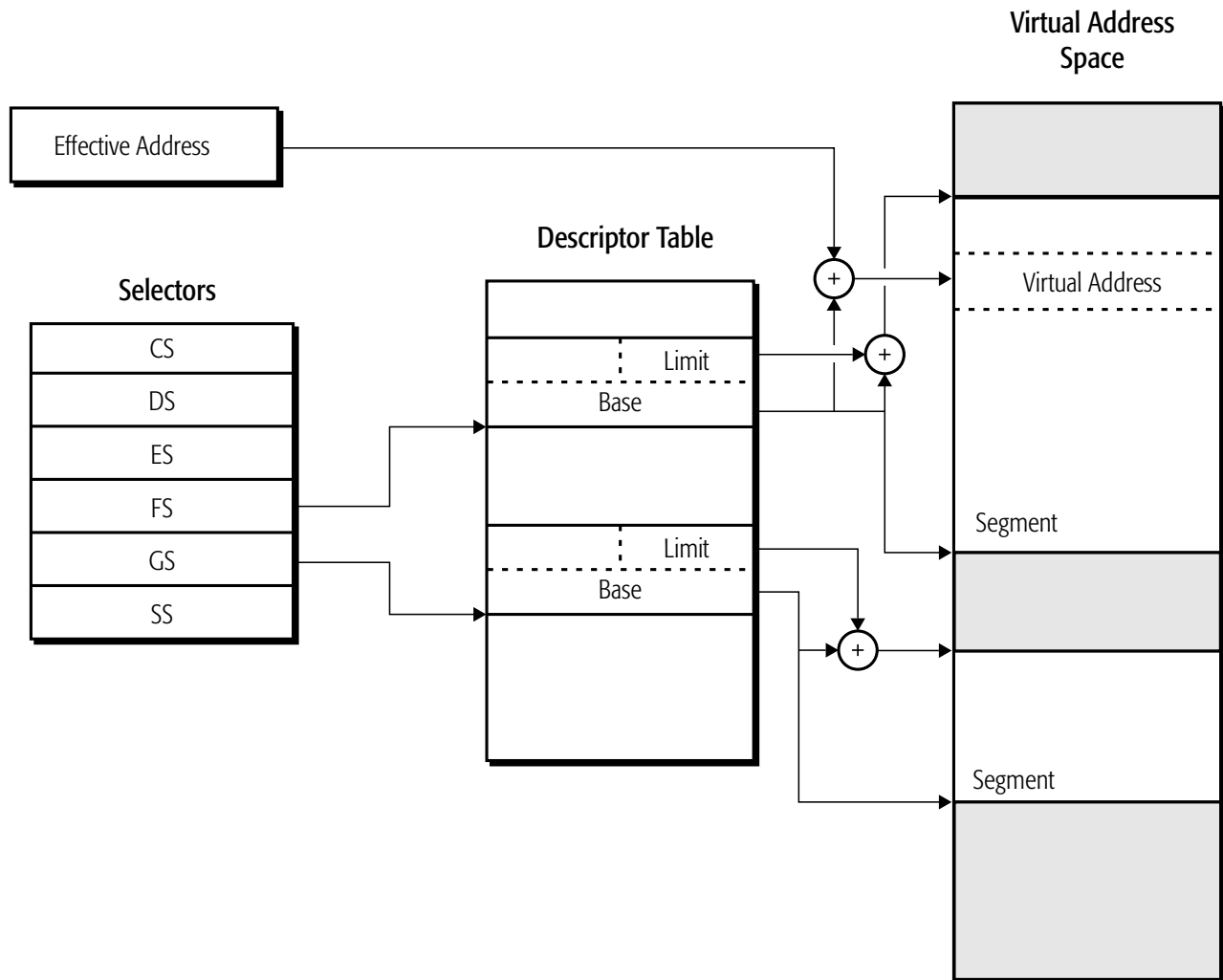

**Figure 1-1. Segmented-Memory Model**

**Flat Segmentation.** One special case of segmented memory is the flat-memory model. In the legacy flat-memory model, all segment-base addresses have a value of 0, and the segment limits are fixed at 4 Gbytes. Segmentation cannot be disabled but use of the flat-memory model effectively disables segment translation. The result is a virtual address that equals the effective address. Figure 1-2 on page 7 shows an example of the flat-memory model.

Software running in 64-bit mode automatically uses the flat-memory model. In 64-bit mode, the segment base is treated as if it were 0, and the segment limit is ignored. This allows an effective addresses to access the full virtual-address space supported by the processor.

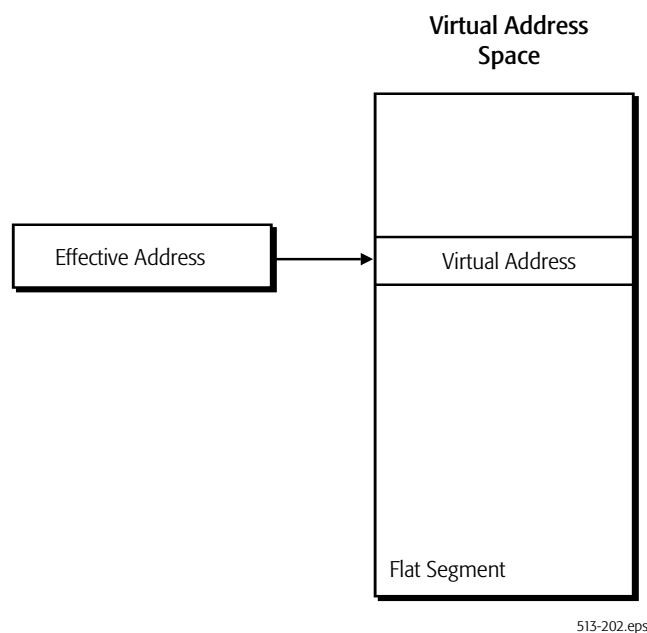

**Figure 1-2. Flat Memory Model**

## 1.2.2 Paging

Paging allows software and data to be relocated in physical-address space using fixed-size blocks called *physical pages*. The legacy x86 architecture supports three different physical-page sizes of 4 Kbytes, 2 Mbytes, and 4 Mbytes. As with segment translation, access to physical pages by lesser-privileged software can be restricted.

Page translation uses a hierarchical data structure called a page-translation table to translate virtual pages into physical-pages. The number of levels in the translation-table hierarchy can be as few as one or as many as four, depending on the physical-page size and processor operating mode. Translation tables are aligned on 4-Kbyte boundaries. Physical pages must be aligned on 4-Kbyte, 2-Mbyte, or 4-Mbyte boundaries, depending on the physical-page size.

Each table in the translation hierarchy is indexed by a portion of the virtual-address bits. The entry referenced by the table index contains a pointer to the base address of the next-lower-level table in the translation hierarchy. In the case of the lowest-level table, its entry points to the physical-page base address. The physical page is then indexed by the least-significant bits of the virtual address to yield the physical address.

Figure 1-3 on page 8 shows an example of paged memory with three levels in the translation-table hierarchy. Paging is described in Chapter 5, “Page Translation and Protection.”

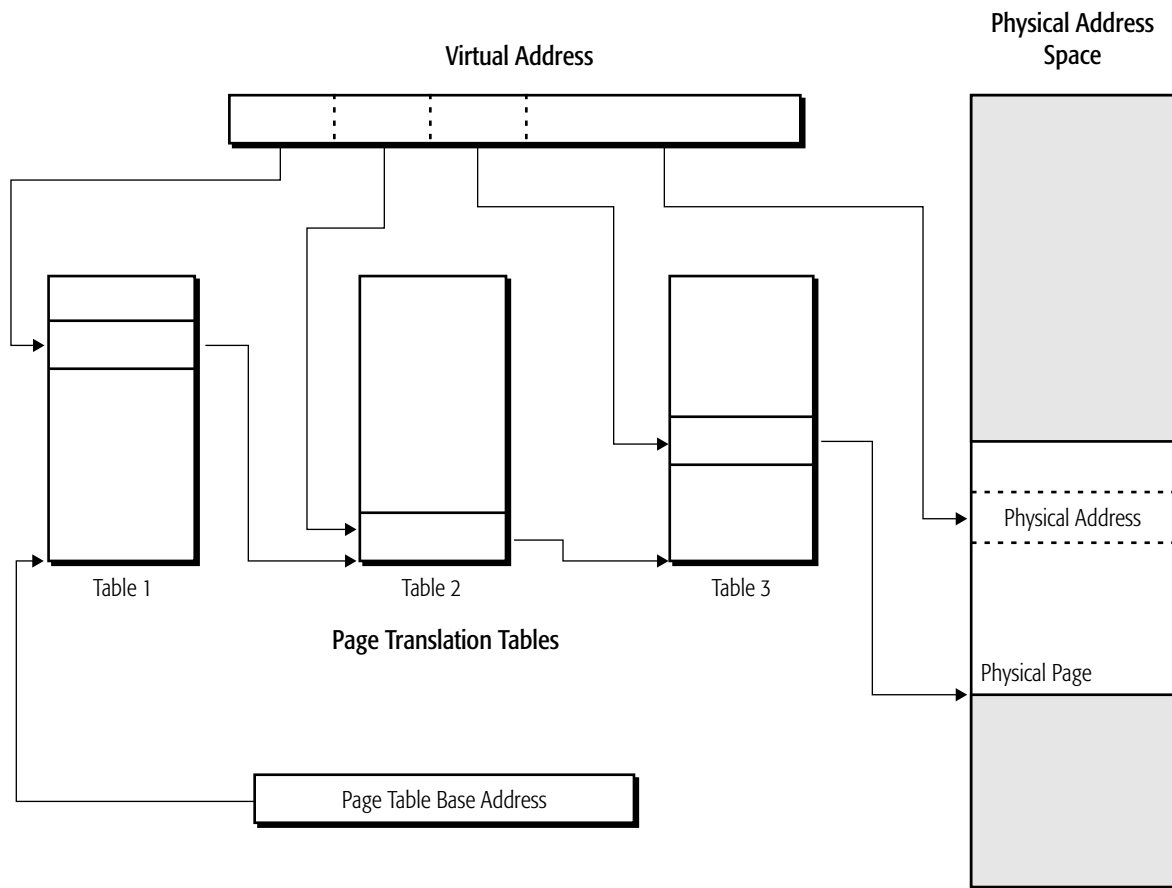

**Figure 1-3. Paged Memory Model**

Software running in long mode is required to have page translation enabled.

### 1.2.3 Mixing Segmentation and Paging

Memory-management software can combine the use of segmented memory and paged memory. Because segmentation cannot be disabled, paged-memory management requires some minimum initialization of the segmentation resources. Paging can be completely disabled, so segmented-memory management does not require initialization of the paging resources.

Segments can range in size from a single byte to 4 Gbytes in length. It is therefore possible to map multiple segments to a single physical page and to map multiple physical pages to a single segment. Alignment between segment and physical-page boundaries is not required, but memory-management software is simplified when segment and physical-page boundaries are aligned.



The simplest, most efficient method of memory management is the flat-memory model. In the flat-memory model, all segment base addresses have a value of 0 and the segment limits are fixed at 4 Gbytes. The segmentation mechanism is still used each time a memory reference is made, but because virtual addresses are identical to effective addresses in this model, the segmentation mechanism is effectively ignored. Translation of virtual (or effective) addresses to physical addresses takes place using the paging mechanism only.

Because 64-bit mode disables segmentation, it uses a flat, paged-memory model for memory management. The 4 Gbyte segment limit is ignored in 64-bit mode. Figure 1-4 shows an example of this model.

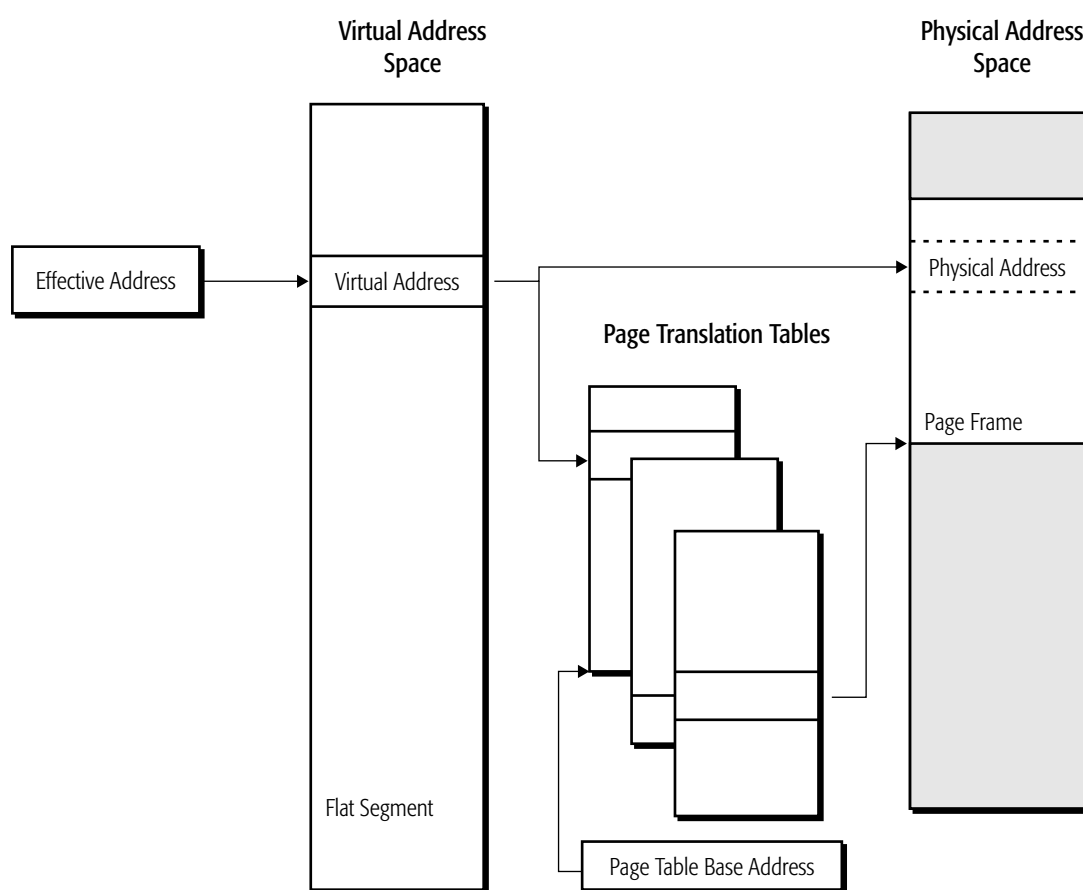

**Figure 1-4. 64-Bit Flat, Paged-Memory Model**

## 1.2.4 Real Addressing

Real addressing is a legacy-mode form of address translation used in real mode. This simplified form of address translation is backward compatible with 8086-processor effective-to-physical address translation. In this mode, 16-bit effective addresses are mapped to 20-bit physical addresses, providing a 1-Mbyte physical-address space.

Segment selectors are used in real-address translation, but not as an index into a descriptor table. Instead, the 16-bit segment-selector value is shifted left by 4 bits to form a 20-bit segment-base address. The 16-bit effective address is added to this 20-bit segment base address to yield a 20-bit physical address. If the sum of the segment base and effective address carries over into bit 20, that bit can be optionally truncated to mimic the 20-bit address wrapping of the 8086 processor by using the A20M# input signal to mask the A20 address bit.

A20 address bit masking should only be used real mode (see next section for information on real mode). Use in other modes may result in address translation errors.

Real-address translation supports a 1-Mbyte physical-address space using up to 64K segments aligned on 16-byte boundaries. Each segment is exactly 64 Kbytes long. Figure 1-5 shows an example of real-address translation.

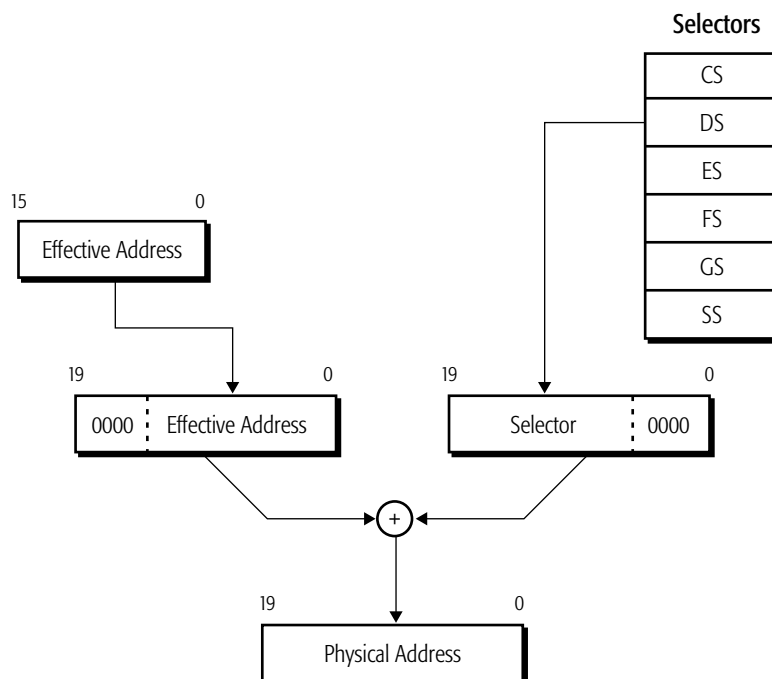

**Figure 1-5. Real-Address Memory Model**

## 1.3 Operating Modes

The legacy x86 architecture provides four operating modes or environments that support varying forms of memory management, virtual-memory and physical-memory sizes, and protection:

- Real Mode.
- Protected Mode.
- Virtual-8086 Mode.
- System Management Mode.

The AMD64 architecture supports all these legacy modes, and it adds a new operating mode called *long mode*. Table 1-1 shows the differences between long mode and legacy mode. Software can move between all supported operating modes as shown in Figure 1-6 on page 12. Each operating mode is described in the following sections.

**Table 1-1. Operating Modes**

Mode		System Software Required	Application Recompile Required	Defaults <sup>1</sup>		Register Extensions <sup>2</sup>	Maximum GPR Width (bits)
				Address Size (bits)	Operand Size (bits)		
Long Mode <sup>3</sup>	64-Bit Mode	New 64-bit OS	yes	64	32	yes	64
	Compatibility Mode		no	32		16	no
Legacy Mode	Protected Mode	Legacy 32-bit OS		no	32		
	Virtual-8086 Mode		16		16		
	Real Mode	Legacy 16-bit OS	16		16	32	

**Note:**

1. Defaults can be overridden in most modes using an instruction prefix or system control bit.
2. Register extensions include access to the upper eight general-purpose and YMM/XMM registers, uniform access to lower 8 bits of all GPRs, and access to the upper 32 bits of the GPRs.
3. Long mode supports only x86 protected mode. It does not support x86 real mode or virtual-8086 mode.

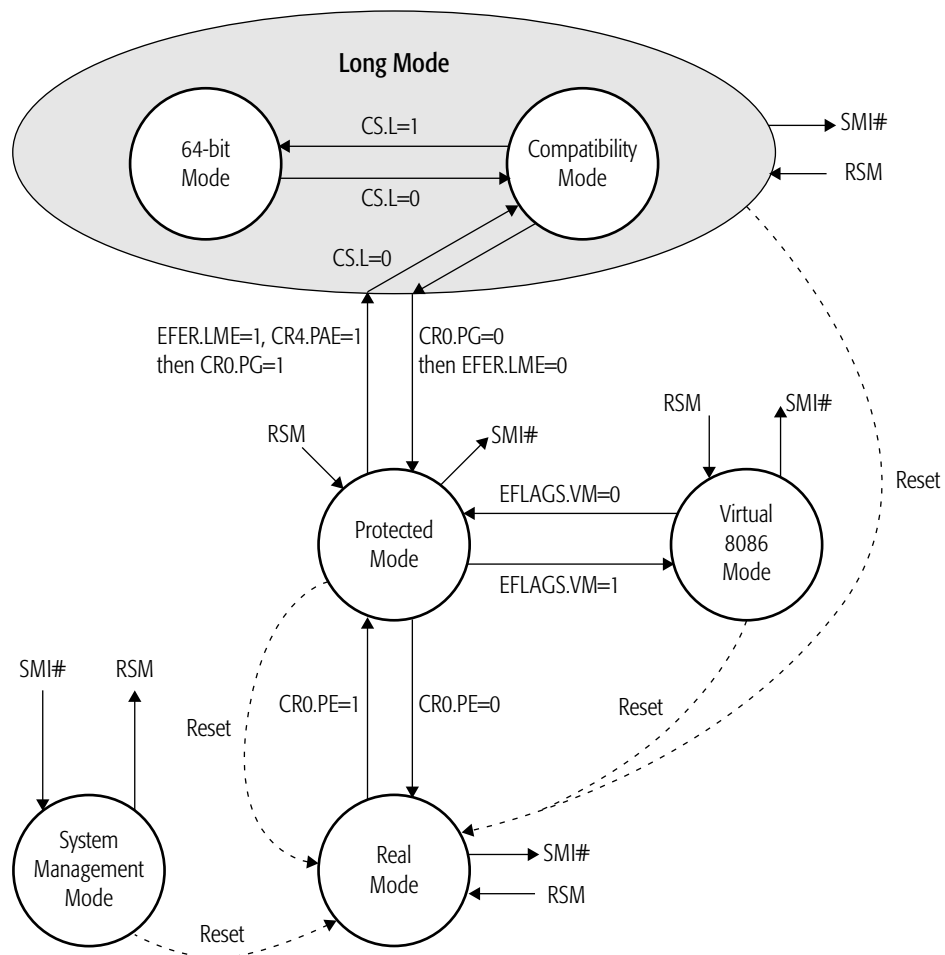

**Figure 1-6. Operating Modes of the AMD64 Architecture**

### 1.3.1 Long Mode

Long mode consists of two submodes: *64-bit mode* and *compatibility mode*. 64-bit mode supports several new features, including the ability to address 64-bit virtual-address space. Compatibility mode provides binary compatibility with existing 16-bit and 32-bit applications when running on 64-bit system software.

Throughout this document, references to *long mode* refer collectively to both *64-bit mode* and *compatibility mode*. If a function is specific to either 64-bit mode or compatibility mode, then those specific names are used instead of the name *long mode*.

Before enabling and activating long mode, system software must first enable protected mode. The process of enabling and activating long mode is described in Chapter 14, “Processor Initialization and

Long Mode Activation.” Long mode features are described throughout this document, where applicable.

### 1.3.2 64-Bit Mode

64-bit mode, a submode of long mode, provides support for 64-bit system software and applications by adding the following features:

- 64-bit virtual addresses (processor implementations can have fewer).
- Access to General Purpose Register bits 63:32
- Access to additional registers through the REX, VEX, and XOP instruction prefixes:
  - eight additional GPRs (R8–R15)
  - eight additional Streaming SIMD Extension (SSE) registers (YMM/XMM8–15)
- 64-bit instruction pointer (RIP).
- New RIP-relative data-addressing mode.
- Flat-segment address space with single code, data, and stack space.

The mode is enabled by the system software on an individual code-segment basis. Although code segments are used to enable and disable 64-bit mode, the legacy segmentation mechanism is largely disabled. Page translation is required for memory management purposes. Because 64-bit mode supports a 64-bit virtual-address space, it requires 64-bit system software and development tools.

In 64-bit mode, the default address size is 64 bits, and the default operand size is 32 bits. The defaults can be overridden on an instruction-by-instruction basis using instruction prefixes. A new REX prefix is introduced for specifying a 64-bit operand size and the new registers.

### 1.3.3 Compatibility Mode

Compatibility mode, a submode of long mode, allows system software to implement binary compatibility with existing 16-bit and 32-bit x86 applications. It allows these applications to run, without recompilation, under 64-bit system software in long mode, as shown in Table 1-1 on page 11.

In compatibility mode, applications can only access the first 4 Gbytes of virtual-address space. Standard x86 instruction prefixes toggle between 16-bit and 32-bit address and operand sizes.

Compatibility mode, like 64-bit mode, is enabled by system software on an individual code-segment basis. Unlike 64-bit mode, however, segmentation functions the same as in the legacy-x86 architecture, using 16-bit or 32-bit protected-mode semantics. From an application viewpoint, compatibility mode looks like a legacy protected-mode environment. From a system-software viewpoint, the long-mode mechanisms are used for address translation, interrupt and exception handling, and system data-structures.

### 1.3.4 Legacy Modes

*Legacy mode* consists of three submodes: real mode, protected mode, and virtual-8086 mode. Protected mode can be either paged or unpaged. *Legacy mode* preserves binary compatibility not only with existing x86 16-bit and 32-bit applications but also with existing x86 16-bit and 32-bit system software.

**Real Mode.** In this mode, also called real-address mode, the processor supports a physical-memory space of 1 Mbyte and operand sizes of 16 bits (default) or 32 bits (with instruction prefixes). Interrupt handling and address generation are nearly identical to the 80286 processor's real mode. Paging is not supported. All software runs at privilege level 0.

Real mode is entered after reset or processor power-up. The mode is not supported when the processor is operating in long mode because long mode requires that paged protected mode be enabled.

**Protected Mode.** In this mode, the processor supports virtual-memory and physical-memory spaces of 4 Gbytes and operand sizes of 16 or 32 bits. All segment translation, segment protection, and hardware multitasking functions are available. System software can use segmentation to relocate effective addresses in virtual-address space. If paging is not enabled, virtual addresses are equal to physical addresses. Paging can be optionally enabled to allow translation of virtual addresses to physical addresses and to use the page-based memory-protection mechanisms.

In protected mode, software runs at privilege levels 0, 1, 2, or 3. Typically, application software runs at privilege level 3, the system software runs at privilege levels 0 and 1, and privilege level 2 is available to system software for other uses. The 16-bit version of this mode was first introduced in the 80286 processor.

**Virtual-8086 Mode.** Virtual-8086 mode allows system software to run 16-bit real-mode software on a virtualized-8086 processor. In this mode, software written for the 8086, 8088, 80186, or 80188 processor can run as a privilege-level-3 task under protected mode. The processor supports a virtual-memory space of 1 Mbytes and operand sizes of 16 bits (default) or 32 bits (with instruction prefixes), and it uses real-mode address translation.

Virtual-8086 mode is enabled by setting the virtual-machine bit in the EFLAGS register (EFLAGS.VM). EFLAGS.VM can only be set or cleared when the EFLAGS register is loaded from the TSS as a result of a task switch, or by executing an IRET instruction from privileged software. The POPF instruction cannot be used to set or clear the EFLAGS.VM bit.

Virtual-8086 mode is not supported when the processor is operating in long mode. When long mode is enabled, any attempt to enable virtual-8086 mode is silently ignored.

### 1.3.5 System Management Mode (SMM)

System management mode (SMM) is an operating mode designed for system-control activities that are typically transparent to conventional system software. Power management is one popular use for system management mode. SMM is primarily targeted for use by platform firmware and specialized low-level device drivers. The code and data for SMM are stored in the SMM memory area, which is isolated from main memory by the SMM output signal.

SMM is entered by way of a system management interrupt (SMI). Upon recognizing an SMI, the processor enters SMM and switches to a separate address space where the SMM handler is located and executes. In SMM, the processor supports real-mode addressing with 4 Gbyte segment limits and default operand, address, and stack sizes of 16 bits (prefixes can be used to override these defaults).

## 1.4 System Registers

Figure 1-7 on page 16 shows the system registers defined for the AMD64 architecture. System software uses these registers to, among other things, manage the processor operating environment, define system resource characteristics, and to monitor software execution. With the exception of the RFLAGS register, system registers can be read and written only from privileged software.

Except for the descriptor-table registers and task register, the AMD64 architecture defines all system registers to be 64 bits wide. The descriptor table and task registers are defined by the AMD64 architecture to include 64-bit base-address fields, in addition to their other fields.

As shown in Figure 1-7 on page 16, the system registers include:

- *Control Registers*—These registers are used to control system operation and some system features. See “System-Control Registers” on page 41 for details.
- *System-Flags Register*—The RFLAGS register contains system-status flags and masks. It is also used to enable virtual-8086 mode and to control application access to I/O devices and interrupts. See “RFLAGS Register” on page 52 for details.
- *Descriptor-Table Registers*—These registers contain the location and size of descriptor tables stored in memory. Descriptor tables hold segmentation data structures used in protected mode. See “Descriptor Tables” on page 73 for details.
- *Task Register*—The task register contains the location and size in memory of the task-state segment. The hardware-multitasking mechanism uses the task-state segment to hold state information for a given task. The TSS also holds other data, such as the inner-level stack pointers used when changing to a higher privilege level. See “Task Register” on page 331 for details.
- *Debug Registers*—Debug registers are used to control the software-debug mechanism, and to report information back to a debug utility or application. See “Debug Registers” on page 348 for details.

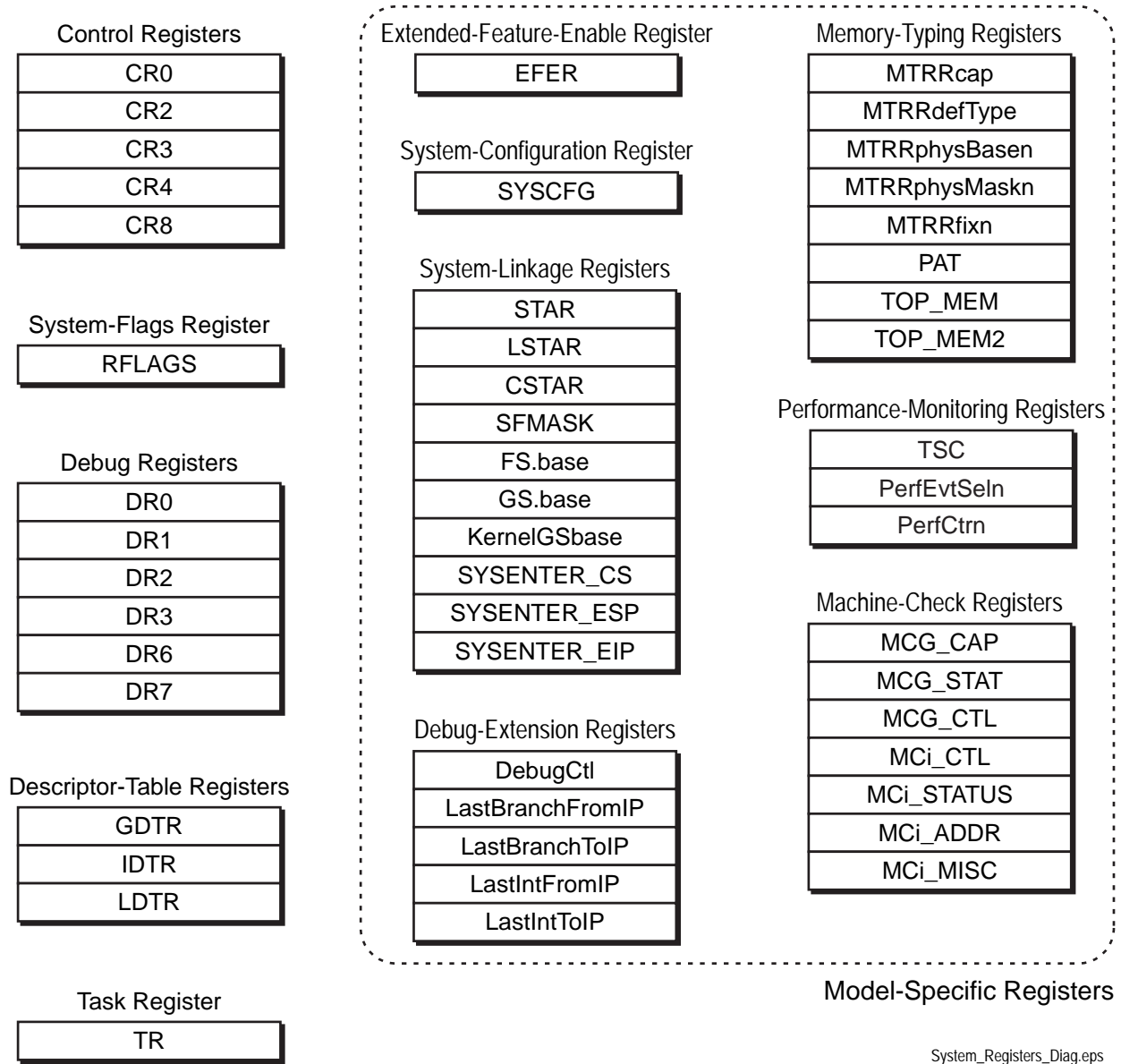

System\_Registers\_Diag.eps

**Figure 1-7. System Registers**

Also defined as system registers are a number of *model-specific registers* included in the AMD64 architectural definition, and shown in Figure 1-7:

- *Extended-Feature-Enable Register*—The EFER register is used to enable and report status on special features not controlled by the CR<sub>n</sub> control registers. In particular, EFER is used to control activation of long mode. See “Extended Feature Enable Register (EFER)” on page 55 for more information.



- *System-Configuration Register*—The SYSCFG register is used to enable and configure system-bus features. See “System Configuration Register (SYSCFG)” on page 59 for more information.
- *System-Linkage Registers*—These registers are used by system-linkage instructions to specify operating-system entry points, stack locations, and pointers into system-data structures. See “Fast System Call and Return” on page 152 for details.
- *Memory-Typing Registers*—Memory-typing registers can be used to characterize (type) system memory. Typing memory gives system software control over how instructions and data are cached, and how memory reads and writes are ordered. See “MTRRs” on page 189 for details.
- *Debug-Extension Registers*—These registers control additional software-debug reporting features. See “Debug Registers” on page 348 for details.
- *Performance-Monitoring Registers*—Performance-monitoring registers are used to count processor and system events, or the duration of events. See “Performance Monitoring Counters” on page 362 for more information.
- *Machine-Check Registers*—The machine-check registers control the response of the processor to non-recoverable failures. They are also used to report information on such failures back to system utilities designed to respond to such failures. See “Machine Check Architecture MSRs” on page 265 for more information.

## 1.5 System-Data Structures

Figure 1-8 on page 18 shows the system-data structures defined for the AMD64 architecture. System-data structures are created and maintained by system software for use by the processor when running in protected mode. A processor running in protected mode uses these data structures to manage memory and protection, and to store program-state information when an interrupt or task switch occurs.

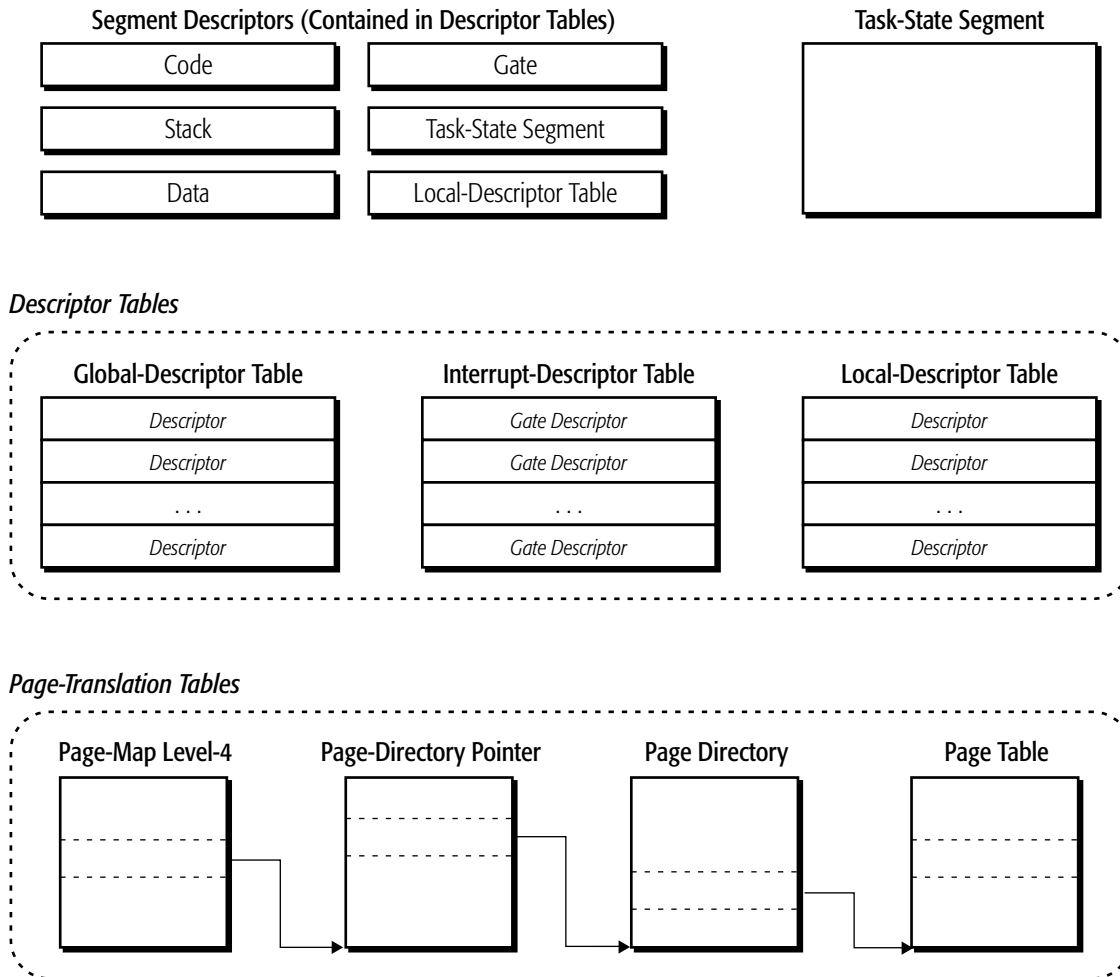

**Figure 1-8. System-Data Structures**

As shown in Figure 1-8, the system-data structures include:

- *Descriptors*—A descriptor provides information about a segment to the processor, such as its location, size and privilege level. A special type of descriptor, called a *gate*, is used to provide a code selector and entry point for a software routine. Any number of descriptors can be defined, but system software must at a minimum create a descriptor for the currently executing code segment and stack segment. See “Legacy Segment Descriptors” on page 80, and “Long-Mode Segment Descriptors” on page 88 for complete information on descriptors.
- *Descriptor Tables*—As the name implies, descriptor tables hold descriptors. The global-descriptor table holds descriptors available to all programs, while a local-descriptor table holds descriptors used by a single program. The interrupt-descriptor table holds only gate descriptors used by

interrupt handlers. System software must initialize the global-descriptor and interrupt-descriptor tables, while use of the local-descriptor table is optional. See “Descriptor Tables” on page 73 for more information.

- *Task-State Segment*—The task-state segment is a special segment for holding processor-state information for a specific program, or task. It also contains the stack pointers used when switching to more-privileged programs. The hardware multitasking mechanism uses the state information in the segment when suspending and resuming a task. Calls and interrupts that switch stacks cause the stack pointers to be read from the task-state segment. System software must create at least one task-state segment, even if hardware multitasking is not used. See “Legacy Task-State Segment” on page 333, and “64-Bit Task State Segment” on page 337 for details.
- *Page-Translation Tables*—Use of page translation is optional in protected mode, but it is required in long mode. A four-level page-translation data structure is provided to allow long-mode operating systems to translate a 64-bit virtual-address space into a 52-bit physical-address space. Legacy protected mode can use two- or three-level page-translation data structures. See “Page Translation Overview” on page 118 for more information on page translation.

## 1.6 Interrupts

The AMD64 architecture provides a mechanism for the processor to automatically suspend (interrupt) software execution and transfer control to an interrupt handler when an interrupt or exception occurs. An interrupt handler is privileged software designed to identify and respond to the cause of an interrupt or exception, and return control back to the interrupted software. *Interrupts* can be caused when system hardware signals an interrupt condition using one of the external-interrupt signals on the processor. Interrupts can also be caused by software that executes an interrupt instruction. *Exceptions* occur when the processor detects an abnormal condition as a result of executing an instruction. The term “interrupts” as used throughout this volume includes both interrupts and exceptions when the distinction is unnecessary.

System software not only sets up the interrupt handlers, but it must also create and initialize the data structures the processor uses to execute an interrupt handler when an interrupt occurs. The data structures include the code-segment descriptors for the interrupt-handler software and any data-segment descriptors for data and stack accesses. Interrupt-gate descriptors must also be supplied. Interrupt gates point to interrupt-handler code-segment descriptors, and the entry point in an interrupt handler. Interrupt gates are stored in the interrupt-descriptor table. The code-segment and data-segment descriptors are stored in the global-descriptor table and, optionally, the local-descriptor table.

When an interrupt occurs, the processor uses the interrupt vector to find the appropriate interrupt gate in the interrupt-descriptor table. The gate points to the interrupt-handler code segment and entry point, and the processor transfers control to that location. Before invoking the interrupt handler, the processor saves information required to return to the interrupted program. For details on how the processor transfers control to interrupt handlers, see “Legacy Protected-Mode Interrupt Control Transfers” on page 237, and “Long-Mode Interrupt Control Transfers” on page 247.

Table 1-2 shows the supported interrupts and exceptions, ordered by their vector number. Refer to “Vectors” on page 214 for a complete description of each interrupt, and a description of the interrupt mechanism.

**Table 1-2. Interrupts and Exceptions**

Vector	Description
0	Integer Divide-by-Zero Exception
1	Debug Exception
2	Non-Maskable-Interrupt
3	Breakpoint Exception (INT 3)
4	Overflow Exception (INTO instruction)
5	Bound-Range Exception (BOUND instruction)
6	Invalid-Opcode Exception
7	Device-Not-Available Exception
8	Double-Fault Exception
9	Coprocessor-Segment-Overrun Exception (reserved in AMD64)
10	Invalid-TSS Exception
11	Segment-Not-Present Exception
12	Stack Exception
13	General-Protection Exception
14	Page-Fault Exception
15	(Reserved)
16	x87 Floating-Point Exception
17	Alignment-Check Exception
18	Machine-Check Exception
19	SIMD Floating-Point Exception
0–255	Interrupt Instructions
0–255	Hardware Maskable Interrupts

## 1.7 Additional System-Programming Facilities

### 1.7.1 Hardware Multitasking

A task is any program that the processor can execute, suspend, and later resume executing at the point of suspension. During the time a task is suspended, other tasks are allowed to execute. Each task has its own execution space, consisting of a code segment, data segments, and a stack segment for each privilege level. Tasks can also have their own virtual-memory environment managed by the page-translation mechanism. The state information defining this execution space is stored in the task-state segment (TSS) maintained for each task.

Support for hardware multitasking is provided by implementations of the AMD64 architecture when software is running in legacy mode. Hardware multitasking provides automated mechanisms for switching tasks, saving the execution state of the suspended task, and restoring the execution state of the resumed task. When hardware multitasking is used to switch tasks, the processor takes the following actions:

- The processor automatically suspends execution of the task, allowing any executing instructions to complete and save their results.
- The execution state of a task is saved in the task TSS.
- The execution state of a new task is loaded into the processor from its TSS.
- The processor begins executing the new task at the location specified in the new task TSS.

Use of hardware-multitasking features is optional in legacy mode. Generally, modern operating systems do not use the hardware-multitasking features, and instead perform task management entirely in software. Long mode does not support hardware multitasking at all.

Whether hardware multitasking is used or not, system software must create and initialize at least one task-state segment data-structure. This requirement holds for both long-mode and legacy-mode software. The single task-state segment holds critical pieces of the task execution environment and is referenced during certain control transfers.

Detailed information on hardware multitasking is available in Chapter 12, “Task Management,” along with a full description of the requirements that must be met in initializing a task-state segment when hardware multitasking is not used.

### 1.7.2 Machine Check

Implementations of the AMD64 architecture support the machine-check exception. This exception is useful in system applications with stringent requirements for reliability, availability, and serviceability. The exception allows specialized system-software utilities to report hardware errors that are generally severe and non-recoverable. Providing the capability to report such errors can allow complex system problems to be pinpointed rapidly.

The machine-check exception is described in Chapter 9, “Machine Check Architecture.” Much of the error-reporting capabilities is implementation dependent. For more information, developers of machine-check error-reporting software should refer to the *BIOS and Kernel Developer’s Guide* applicable to your product.

### 1.7.3 Software Debugging

A software-debugging mechanism is provided in hardware to help software developers quickly isolate programming errors. This capability can be used to debug system software and application software alike. Only privileged software can access the debugging facilities. Generally, software-debug support is provided by a privileged application program rather than by the operating system itself.

The facilities supported by the AMD64 architecture allow debugging software to perform the following:

- Set breakpoints on specific instructions within a program.
- Set breakpoints on an instruction-address match.
- Set breakpoints on a data-address match.
- Set breakpoints on specific I/O-port addresses.
- Set breakpoints to occur on task switches when hardware multitasking is used.
- Single step an application instruction-by-instruction.
- Single step only branches and interrupts.
- Record a history of branches and interrupts taken by a program.

The debugging facilities are fully described in “Software-Debug Resources” on page 348. Some processors provide additional, implementation-specific debug support. For more information, refer to the *BIOS and Kernel Developer’s Guide* applicable to your product.

#### 1.7.4 Performance Monitoring

For many software developers, the ability to identify and eliminate performance bottlenecks from a program is nearly as important as quickly isolating programming errors. Implementations of the AMD64 architecture provide hardware performance-monitoring resources that can be used by special software applications to identify such bottlenecks. Non-privileged software can access the performance monitoring facilities, but only if privileged software grants that access.

The performance-monitoring facilities allow the counting of events, or the duration of events. Performance-analysis software can use the data to calculate the frequency of certain events, or the time spent performing specific activities. That information can be used to suggest areas for improvement and the types of optimizations that are helpful.

The performance-monitoring facilities are fully described in “Performance Monitoring Counters” on page 362. The specific events that can be monitored are generally implementation specific. For more information, refer to the *BIOS and Kernel Developer’s Guide* applicable to your product.

---

## 2 x86 and AMD64 Architecture Differences

---

The AMD64 architecture is designed to provide full binary compatibility with all previous AMD implementations of the x86 architecture. This chapter summarizes the new features and architectural enhancements introduced by the AMD64 architecture, and compares those features and enhancements with previous AMD x86 processors. Most of the new capabilities introduced by the AMD64 architecture are available only in long mode (64-bit mode, compatibility mode, or both). However, some of the new capabilities are also available in legacy mode, and are mentioned where appropriate.

The material throughout this chapter assumes the reader has a solid understanding of the x86 architecture. For those who are unfamiliar with the x86 architecture, please read the remainder of this volume before reading this chapter.

### 2.1 Operating Modes

See “Operating Modes” on page 11 for a complete description of the operating modes supported by the AMD64 architecture.

#### 2.1.1 Long Mode

The AMD64 architecture introduces long mode and its two sub-modes: 64-bit mode and compatibility mode.

**64-Bit Mode.** 64-bit mode provides full support for 64-bit system software and applications. The new features introduced in support of 64-bit mode are summarized throughout this chapter. To use 64-bit mode, a 64-bit operating system and tool chain are required.

**Compatibility Mode.** Compatibility mode allows 64-bit operating systems to implement binary compatibility with existing 16-bit and 32-bit x86 applications. It allows these applications to run, without recompilation, under control of a 64-bit operating system in long mode. The architectural enhancements introduced by the AMD64 architecture that support compatibility mode are summarized throughout this chapter.

**Unsupported Modes.** Long mode does not support the following two operating modes:

- *Virtual-8086 Mode*—The virtual-8086 mode bit (EFLAGS.VM) is ignored when the processor is running in long mode. When long mode is enabled, any attempt to enable virtual-8086 mode is silently ignored. System software must leave long mode in order to use virtual-8086 mode.
- *Real Mode*—Real mode is not supported when the processor is operating in long mode because long mode requires that protected mode be enabled.

#### 2.1.2 Legacy Mode

The AMD64 architecture supports a pure x86 legacy mode, which preserves binary compatibility not only with existing 16-bit and 32-bit applications but also with existing 16-bit and 32-bit operating

systems. *Legacy mode* supports real mode, protected mode, and virtual-8086 mode. A reset always places the processor in legacy mode (real mode), and the processor continues to run in legacy mode until system software activates long mode. New features added by the AMD64 architecture that are supported in legacy mode are summarized in this chapter.

### 2.1.3 System-Management Mode

The AMD64 architecture supports system-management mode (SMM). SMM can be entered from both long mode and legacy mode, and SMM can return directly to either mode. The following differences exist between the support of SMM in the AMD64 architecture and the SMM support found in previous processor generations:

- The SMRAM state-save area format is changed to hold the 64-bit processor state. This state-save area format is used regardless of whether SMM is entered from long mode or legacy mode.
- The auto-halt restart and I/O-instruction restart entries in the SMRAM state-save area are one byte instead of two bytes.
- The initial processor state upon entering SMM is expanded to reflect the 64-bit nature of the processor.
- New conditions exist that can cause a processor shutdown while exiting SMM.
- SMRAM caching considerations are modified because the legacy FLUSH# external signal (writeback, if modified, and invalidate) is not supported on implementations of the AMD64 architecture.

See Chapter 10, “System-Management Mode,” for more information on the SMM differences.

## 2.2 Memory Model

The AMD64 architecture provides enhancements to the legacy memory model to support very large physical-memory and virtual-memory spaces while in long mode. Some of this expanded support for physical memory is available in legacy mode.

### 2.2.1 Memory Addressing

**Virtual-Memory Addressing.** Virtual-memory support is expanded to 64 address bits in long mode. This allows up to 16 exabytes of virtual-address space to be accessed. The virtual-address space supported in legacy mode is unchanged.

**Physical-Memory Addressing.** Physical-memory support is expanded to 52 address bits in long mode and legacy mode. This allows up to 4 petabytes of physical memory to be accessed. The expanded physical-memory support is achieved by using paging and the page-size extensions.

Note that given processor may implement less than the architecturally-defined physical address size of 52 bits.



**Effective Addressing.** The effective-address length is expanded to 64 bits in long mode. An effective-address calculation uses 64-bit base and index registers, and sign-extends 8-bit and 32-bit displacements to 64 bits. In legacy mode, effective addresses remain 32 bits long.

## 2.2.2 Page Translation

The AMD64 architecture defines an expanded page-translation mechanism supporting translation of a 64-bit virtual address to a 52-bit physical address. See “Long-Mode Page Translation” on page 130 for detailed information on the enhancements to page translation in the AMD64 architecture. The enhancements are summarized below.

**Physical-Address Extensions (PAE).** The AMD64 architecture requires physical-address extensions to be enabled (CR4.PAE=1) before long mode is entered. When PAE is enabled, all paging data-structures are 64 bits, allowing references into the full 52-bit physical-address space supported by the architecture.

**Page-Size Extensions (PSE).** Page-size extensions (CR4.PSE) are ignored in long mode. Long mode does not support the 4-Mbyte page size enabled by page-size extensions. Long mode does, however, support 4-Kbyte and 2-Mbyte page sizes.

**Paging Data Structures.** The AMD64 architecture extends the page-translation data structures in support of long mode. The extensions are:

- *Page-map level-4 (PML4)*—Long mode defines a new page-translation data structure, the PML4 table. The PML4 table sits at the top of the page-translation hierarchy and references PDP tables.
- *Page-directory pointer (PDP)*—The PDP tables in long mode are expanded from 4 entries to 512 entries each.
- *Page-directory pointer entry (PDPE)*—Previously undefined fields within the legacy-mode PDPE are defined by the AMD64 architecture.

**CR3 Register.** The CR3 register is expanded to 64 bits for use in long-mode page translation. When long mode is active, the CR3 register references the base address of the PML4 table. In legacy mode, the upper 32 bits of CR3 are masked by the processor to support legacy page translation. CR3 references the PDP base-address when physical-address extensions are enabled, or the page-directory table base-address when physical-address extensions are disabled.

**Legacy-Mode Enhancements.** Legacy-mode software can take advantage of the enhancements made to the physical-address extension (PAE) support and page-size extension (PSE) support. The four-level page translation mechanism introduced by long mode is not available to legacy-mode software.

- *PAE*—When physical-address extensions are enabled (CR4.PAE=1), the AMD64 architecture allows legacy-mode software to load up to 52-bit (maximum size) physical addresses into the PDE and PTE. Note that addresses are expanded to the maximum physical address size supported by the implementation.

- *PSE*—The use of page-size extensions allows legacy mode software to define 4-Mbyte pages using the 32-bit page-translation tables. When page-size extensions are enabled (CR4.PSE=1), the AMD64 architecture enhances the 4-Mbyte PDE to support 40 physical-address bits.

See “Legacy-Mode Page Translation” on page 122 for more information on these enhancements.

### 2.2.3 Segmentation

In long mode, the effects of segmentation depend on whether the processor is running in compatibility mode or 64-bit mode:

- In compatibility mode, segmentation functions just as it does in legacy mode, using legacy 16-bit or 32-bit protected mode semantics.
- 64-bit mode requires a flat-memory model for creating a flat 64-bit virtual-address space. Much of the segmentation capability present in legacy mode and compatibility mode is disabled when the processor is running in 64-bit mode.

The differences in the segmentation model as defined by the AMD64 architecture are summarized in the following sections. See Chapter 4, “Segmented Virtual Memory,” for a thorough description of these differences.

**Descriptor-Table Registers.** In long mode, the base-address portion of the descriptor-table registers (GDTR, IDTR, LDTR, and TR) are expanded to 64 bits. The full 64-bit base address can only be loaded by software when the processor is running in 64-bit mode (using the LGDT, LIDT, LLDT, and LTR instructions, respectively). However, the full 64-bit base address is *used* by a processor running in compatibility mode (in addition to 64-bit mode) when making a reference into a descriptor table.

A processor running in legacy mode can only load the low 32 bits of the base address, and the high 32 bits are ignored when references are made to the descriptor tables.

**Code-Segment Descriptors.** The AMD64 architecture defines a new code-segment descriptor attribute, L (long). In compatibility mode, the processor treats code-segment descriptors as it does in legacy mode, with the exception that the processor recognizes the L attribute. If a code descriptor with L=1 is loaded in compatibility mode, the processor leaves compatibility mode and enters 64-bit mode. In legacy mode, the L attribute is reserved.

The following differences exist for code-segment descriptors in 64-bit mode only:

- The CS base-address field is ignored by the processor.
- The CS limit field is ignored by the processor.
- Only the L (long), D (default size), and DPL (descriptor-privilege level) fields are used by the processor in 64-bit mode. All remaining attributes are ignored.

**Data-Segment Descriptors.** The following differences exist for data-segment descriptors in 64-bit mode only:

- The DS, ES, and SS descriptor base-address fields are ignored by the processor.

- The FS and GS descriptor base-address fields are expanded to 64 bits and used in effective-address calculations. The 64 bits of base address are mapped to model-specific registers (MSRs), and can only be loaded using the WRMSR instruction.
- The limit fields and attribute fields of all data-segment descriptors (DS, ES, FS, GS, and SS) are ignored by the processor.

In compatibility mode, the processor treats data-segment descriptors as it does in legacy mode. Compatibility mode ignores the high 32 bits of base address in the FS and GS segment descriptors when calculating an effective address.

**System-Segment Descriptors.** In 64-bit mode only, The LDT and TSS system-segment descriptor formats are expanded by 64 bits, allowing them to hold 64-bit base addresses. LLDT and LTR instructions can be used to load these descriptors into the LDTR and TR registers, respectively, from 64-bit mode.

In compatibility mode and legacy mode, the *formats* of the LDT and TSS system-segment descriptors are unchanged. Also, unlike code-segment and data-segment descriptors, system-segment descriptor limits *are checked* by the processor in long mode.

Some legacy mode LDT and TSS type-field encodings are illegal in long mode (both compatibility mode and 64-bit mode), and others are redefined to new types. See “System Descriptors” on page 90 for additional information.

**Gate Descriptors.** The following differences exist between gate descriptors in long mode (both compatibility mode and 64-bit mode) and in legacy mode:

- In long mode, all 32-bit gate descriptors are redefined as 64-bit gate descriptors, and are expanded to hold 64-bit offsets. The length of a gate descriptor in long mode is therefore 128 bits (16 bytes), versus the 64 bits (8 bytes) in legacy mode.
- Some type-field encodings are illegal in long mode, and others are redefined to new types. See “Gate Descriptors” on page 92 for additional information.
- The interrupt-gate and trap-gate descriptors define a new field, called the interrupt-stack table (IST) field.

## 2.3 Protection Checks

The AMD64 architecture makes the following changes to the protection mechanism in long mode:

- The page-protection-check mechanism is expanded in long mode to include the U/S and R/W protection bits stored in the PML4 entries and PDP entries.
- Several system-segment types and gate-descriptor types that are legal in legacy mode are illegal in long mode (compatibility mode and 64-bit mode) and fail type checks when used in long mode.
- Segment-limit checks are disabled in 64-bit mode for the CS, DS, ES, FS, GS, and SS segments. Segment-limit checks remain enabled for the LDT, GDT, IDT and TSS system segments.

All segment-limit checks are performed in compatibility mode.

- Code and data segments used in 64-bit mode are treated as both readable and writable.

See “Page-Protection Checks” on page 145 and “Segment-Protection Overview” on page 95 for detailed information on the protection-check changes.

## 2.4 Registers

The AMD64 architecture adds additional registers to the architecture, and in many cases expands the size of existing registers to 64 bits. The 80-bit floating-point stack registers and their overlaid 64-bit MMX™ registers are not modified by the AMD64 architecture.

### 2.4.1 General-Purpose Registers

In 64-bit mode, the general-purpose registers (GPRs) are 64 bits wide, and eight additional GPRs are available. The GPRs are: RAX, RBX, RCX, RDX, RDI, RSI, RBP, RSP, and the new R8–R15 registers. To access the full 64-bit operand size, or the new R8–R15 registers, an instruction must include a new REX instruction-prefix byte (see “REX Prefixes” on page 29 for a summary of this prefix).

In compatibility and legacy modes, the GPRs consist only of the eight legacy 32-bit registers. All legacy rules apply for determining operand size.

### 2.4.2 YMM/XMM Registers

In 64-bit mode, eight additional YMM/XMM registers are available, YMM/XMM8–15. A REX instruction prefix is used to access these registers. In compatibility and legacy modes, only registers YMM/XMM0–7 are accessible.

### 2.4.3 Flags Register

The flags register is expanded to 64 bits, and is called RFLAGS. All 64 bits can be accessed in 64-bit mode, but the upper 32 bits are reserved and always read back as zeros. Compatibility mode and legacy mode can read and write only the lower-32 bits of RFLAGS (the legacy EFLAGS).

### 2.4.4 Instruction Pointer

In long mode, the instruction pointer is extended to 64 bits, to support 64-bit code offsets. This 64-bit instruction pointer is called RIP.

### 2.4.5 Stack Pointer

In 64-bit mode, the size of the stack pointer, RSP, is always 64 bits. The stack size is not controlled by a bit in the SS descriptor, as it is in compatibility or legacy mode, nor can it be overridden by an instruction prefix. Address-size overrides are ignored for implicit stack references.

## 2.4.6 Control Registers

The AMD64 architecture defines several enhancements to the control registers ( $CR_n$ ). In long mode, all control registers are expanded to 64 bits, although the entire 64 bits can be read and written only from 64-bit mode. A new control register, the task-priority register ( $CR_8$  or TPR) is added, and can be read and written from 64-bit mode. Last, the function of the page-enable bit ( $CR_0.PG$ ) is expanded. When long mode is enabled, the PG bit is used to activate and deactivate long mode.

## 2.4.7 Debug Registers

In long mode, all debug registers are expanded to 64 bits, although the entire 64 bits can be read and written only from 64-bit mode. Expanded register encodings for the decode registers allow up to eight new registers to be defined ( $DR_8$ – $DR_{15}$ ), although presently those registers are not supported by the AMD64 architecture.

## 2.4.8 Extended Feature Register (EFER)

The EFER is expanded by the AMD64 architecture to include a long-mode-enable bit (LME), and a long-mode-active bit (LMA). These new bits can be accessed from legacy mode and long mode.

## 2.4.9 Memory Type Range Registers (MTRRs)

The legacy MTRRs are architecturally defined as 64 bits, and can accommodate the maximum 52-bit physical address allowed by the AMD64 architecture. From both long mode and legacy mode, implementations of the AMD64 architecture reference the entire 52-bit physical-address value stored in the MTRRs. Long mode and legacy mode system software can update all 64 bits of the MTRRs to manage the expanded physical-address space.

## 2.4.10 Other Model-Specific Registers (MSRs)

Several other MSRs have fields holding physical addresses. Examples include the APIC-base register and top-of-memory register. Generally, any model-specific register that contains a physical address is defined architecturally to be 64 bits wide, and can accommodate the maximum physical-address size defined by the AMD64 architecture. When physical addresses are read from MSRs by the processor, the entire value is read regardless of the operating mode. In legacy implementations, the high-order MSR bits are reserved, and software must write those values with zeros. In legacy mode on AMD64 architecture implementations, software can read and write all supported high-order MSR bits.

# 2.5 Instruction Set

## 2.5.1 REX Prefixes

REX prefixes are used in 64-bit mode to:

- Specify the new GPRs and YMM/XMM registers.
- Specify a 64-bit operand size.

- Specify additional control registers. One additional control register, CR8, is defined in 64-bit mode.
- Specify additional debug registers (although none are currently defined).

Not all instructions require a REX prefix. The prefix is necessary only if an instruction references one of the extended registers or uses a 64-bit operand. If a REX prefix is used when it has no meaning, it is ignored.

**Default 64-Bit Operand Size.** In 64-bit mode, two groups of instructions have a default operand size of 64 bits and thus do not need a REX prefix for this operand size:

- Near branches.
- All instructions, except far branches, that implicitly reference the RSP. See “Instructions that Reference RSP” on page 31 for additional information.

### 2.5.2 Segment-Override Prefixes in 64-Bit Mode

In 64-bit mode, the DS, ES, SS, and CS segment-override prefixes have no effect. These four prefixes are no longer treated as segment-override prefixes in the context of multiple-prefix rules. Instead, they are treated as null prefixes.

The FS and GS segment-override prefixes are treated as segment-override prefixes in 64-bit mode. Use of the FS and GS prefixes cause their respective segment bases to be added to the effective address calculation. See “FS and GS Registers in 64-Bit Mode” on page 72 for additional information on using these segment registers.

### 2.5.3 Operands and Results

The AMD64 architecture provides support for using 64-bit operands and generating 64-bit results when operating in 64-bit mode.

**Operand-Size Overrides.** In 64-bit mode, the default operand size is 32 bits. A REX prefix can be used to specify a 64-bit operand size. Software uses a legacy operand-size (66h) prefix to toggle to 16-bit operand size. The REX prefix takes precedence over the legacy operand-size prefix.

**Zero Extension of Results.** In 64-bit mode, when performing 32-bit operations with a GPR destination, the processor zero-extends the 32-bit result into the full 64-bit destination. Both 8-bit and 16-bit operations on GPRs preserve all unwritten upper bits of the destination GPR. This is consistent with legacy 16-bit and 32-bit semantics for partial-width results.

### 2.5.4 Address Calculations

The AMD64 architecture modifies aspects of effective-address calculation to support 64-bit mode. These changes are summarized in the following sections. See “Memory Addressing” in Volume 1 for details.

**Address-Size Overrides.** In 64-bit mode, the default-address size is 64 bits. The address size can be overridden to 32 bits by using the address-size prefix (67h). 16-bit addresses are not supported in 64-bit mode. In compatibility mode and legacy mode, address-size overrides function the same as in x86 legacy architecture.

**Displacements and Immediates.** Generally, displacement and immediate values in 64-bit mode are not extended to 64 bits. They are still limited to 32 bits and are sign extended during effective-address calculations. In 64-bit mode, however, support is provided for some 64-bit displacement and immediate forms of the MOV instruction.

**Zero Extending 16-Bit and 32-Bit Addresses.** All 16-bit and 32-bit address calculations are zero-extended in long mode to form 64-bit addresses. Address calculations are first truncated to the effective-address size of the current mode (64-bit mode or compatibility mode), as overridden by any address-size prefix. The result is then zero-extended to the full 64-bit address width.

**RIP-Relative Addressing.** A new addressing form, RIP-relative (instruction-pointer relative) addressing, is implemented in 64-bit mode. The effective address is formed by adding the displacement to the 64-bit RIP of the next instruction.

## 2.5.5 Instructions that Reference RSP

With the exception of far branches, all instructions that implicitly reference the 64-bit stack pointer, RSP, default to a 64-bit operand size in 64-bit mode (see Table 2-1 for a listing). Pushes and pops of 32-bit stack values are not possible in 64-bit mode with these instructions, but they can be overridden to 16 bits.

**Table 2-1. Instructions That Reference RSP**

Mnemonic	Opcode (hex)	Description
ENTER	C8	Create Procedure Stack Frame
LEAVE	C9	Delete Procedure Stack Frame
POP reg/mem	8F/0	Pop Stack (register or memory)
POP reg	58-5F	Pop Stack (register)
POP FS	0F A1	Pop Stack into FS Segment Register
POP GS	0F A9	Pop Stack into GS Segment Register
POPF, POPFD, POPFQ	9D	Pop to rFLAGS Word, Doubleword, or Quadword
PUSH imm32	68	Push onto Stack (sign-extended doubleword)
PUSH imm8	6A	Push onto Stack (sign-extended byte)
PUSH reg/mem	FF/6	Push onto Stack (register or memory)
PUSH reg	50-57	Push onto Stack (register)
PUSH FS	0F A0	Push FS Segment Register onto Stack
PUSH GS	0F A8	Push GS Segment Register onto Stack
PUSHF, PUSHFD, PUSHFQ	9C	Push rFLAGS Word, Doubleword, or Quadword onto Stack

## 2.5.6 Branches

The AMD64 architecture expands two branching mechanisms to accommodate branches in the full 64-bit virtual-address space:

- In 64-bit mode, near-branch semantics are redefined.
- In both 64-bit and compatibility modes, a 64-bit call-gate descriptor is defined for far calls.

In addition, enhancements are made to the legacy SYSCALL and SYSRET instructions.

**Near Branches.** In 64-bit mode, the operand size for all near branches defaults to 64 bits (see Table 2-2 for a listing). Therefore, these instructions update the full 64-bit RIP without the need for a REX operand-size prefix. The following aspects of near branches default to 64 bits:

- Truncation of the instruction pointer.
- Size of a stack pop or stack push, resulting from a CALL or RET.
- Size of a stack-pointer increment or decrement, resulting from a CALL or RET.
- Size of operand fetched by indirect-branch operand size.

The operand size for near branches can be overridden to 16 bits in 64-bit mode.

**Table 2-2. 64-Bit Mode Near Branches, Default 64-Bit Operand Size**

Mnemonic	Opcode (hex)	Description
CALL	E8, FF/2	Call Procedure Near
Jcc	many	Jump Conditional Near
JMP	E9, EB, FF/4	Jump Near
LOOP	E2	Loop
LOOPcc	E0, E1	Loop Conditional
RET	C3, C2	Return From Call (near)

The address size of near branches is not forced in 64-bit mode. Such addresses are 64 bits by default, but they can be overridden to 32 bits by a prefix.

The size of the displacement field for relative branches is still limited to 32 bits.

**Far Branches Through Long-Mode Call Gates.** Long mode redefines the 32-bit call-gate descriptor type as a 64-bit call-gate descriptor and expands the call-gate descriptor size to hold a 64-bit offset. The long-mode call-gate descriptor allows far branches to reference any location in the supported virtual-address space. In long mode, the call-gate mechanism is changed as follows:

- In long mode, CALL and JMP instructions that reference call-gates must reference 64-bit call gates.
- A 64-bit call-gate descriptor must reference a 64-bit code-segment.



- When a control transfer is made through a 64-bit call gate, the 64-bit target address is read from the 64-bit call-gate descriptor. The base address in the target code-segment descriptor is ignored.

**Stack Switching.** Automatic stack switching is also modified when a control transfer occurs through a call gate in long mode:

- The target-stack pointer read from the TSS is a 64-bit RSP value.
- The SS register is loaded with a null selector. Setting the new SS selector to null allows nested control transfers in 64-bit mode to be handled properly. The SS.RPL value is updated to remain consistent with the newly loaded CPL value.
- The size of pushes onto the new stack is modified to accommodate the 64-bit RIP and RSP values.
- Automatic parameter copying is not supported in long mode.

**Far Returns.** In long mode, far returns can load a null SS selector from the stack under the following conditions:

- The target operating mode is 64-bit mode.
- The target  $CPL < 3$ .

Allowing RET to load SS with a null selector under these conditions makes it possible for the processor to unnest far CALLs (and interrupts) in long mode.

**Task Gates.** Control transfers through task gates are not supported in long mode.

**Branches to 64-Bit Offsets.** Because immediate values are generally limited to 32 bits, the only way a full 64-bit absolute RIP can be specified in 64-bit mode is with an indirect branch. For this reason, direct forms of far branches are eliminated from the instruction set in 64-bit mode.

**SYSCALL and SYSRET Instructions.** The AMD64 architecture expands the function of the legacy SYSCALL and SYSRET instructions in long mode. In addition, two new STAR registers, LSTAR and CSTAR, are provided to hold the 64-bit target RIP for the instructions when they are executed in long mode. The legacy STAR register is not expanded in long mode. See “SYSCALL and SYSRET” on page 152 for additional information.

**SWAPGS Instruction.** The AMD64 architecture provides the SWAPGS instruction as a fast method for system software to load a pointer to system data-structures. SWAPGS is valid only in 64-bit mode. An undefined-opcode exception (#UD) occurs if software attempts to execute SWAPGS in legacy mode or compatibility mode. See “SWAPGS Instruction” on page 155 for additional information.

**SYSENTER and SYSEXIT Instructions.** The SYSENTER and SYSEXIT instructions are invalid in long mode, and result in an invalid opcode exception (#UD) if software attempts to use them. Software should use the SYSCALL and SYSRET instructions when running in long mode. See “SYSENTER and SYSEXIT (Legacy Mode Only)” on page 154 for additional information.

### 2.5.7 NOP Instruction

The legacy x86 architecture commonly uses opcode 90h as a one-byte NOP. In 64-bit mode, the processor treats opcode 90h specially in order to preserve this NOP definition. This is necessary because opcode 90h is actually the XCHG EAX, EAX instruction in the legacy architecture. Without special handling in 64-bit mode, the instruction would not be a true no-operation. Therefore, in 64-bit mode the processor treats opcode 90h (the legacy XCHG EAX, EAX instruction) as a true NOP, regardless of a REX operand-size prefix.

This special handling does not apply to the two-byte ModRM form of the XCHG instruction. Unless a 64-bit operand size is specified using a REX prefix byte, using the two-byte form of XCHG to exchange a register with itself does not result in a no-operation, because the default operation size is 32 bits in 64-bit mode.

### 2.5.8 Single-Byte INC and DEC Instructions

In 64-bit mode, the legacy encodings for the 16 single-byte INC and DEC instructions (one for each of the eight GPRs) are used to encode the REX prefix values. The functionality of these INC and DEC instructions is still available, however, using the ModRM forms of those instructions (opcodes FF /0 and FF /1). See “Single-Byte INC and DEC Instructions in 64-Bit Mode” in Volume 3 for additional information.

### 2.5.9 MOVSXD Instruction

MOVSXD is a new instruction in 64-bit mode (the legacy ARPL instruction opcode, 63h, is reassigned as the MOVSXD opcode). It reads a fixed-size 32-bit source operand from a register or memory and (if a REX prefix is used with the instruction) sign-extends the value to 64 bits. MOVSXD is analogous to the MOVSB instruction, which sign-extends a byte to a word or a word to a doubleword, depending on the effective operand size. See the instruction reference page for the MOVSXD instruction in Volume 3 for additional information.

### 2.5.10 Invalid Instructions

Table 2-3 lists instructions that are illegal in 64-bit mode. Table 2-4 on page 35 lists instructions that are invalid in long mode (both compatibility mode and 64-bit mode). Attempted use of these instructions causes an invalid-opcode exception (#UD) to occur.

**Table 2-3. Invalid Instructions in 64-Bit Mode**

Mnemonic	Opcode (hex)	Description
AAA	37	ASCII Adjust After Addition
AAD	D5	ASCII Adjust Before Division
AAM	D4	ASCII Adjust After Multiply
AAS	3F	ASCII Adjust After Subtraction
BOUND	62	Check Array Bounds

**Table 2-3. Invalid Instructions in 64-Bit Mode (continued)**

Mnemonic	Opcode (hex)	Description
CALL (far)	9A	Procedure Call Far (absolute)
DAA	27	Decimal Adjust after Addition
DAS	2F	Decimal Adjust after Subtraction
INTO	CE	Interrupt to Overflow Vector
JMP (far)	EA	Jump Far (absolute)
LDS	C5	Load DS Segment Register
LES	C4	Load ES Segment Register
POP DS	1F	Pop Stack into DS Segment
POP ES	07	Pop Stack into ES Segment
POP SS	17	Pop Stack into SS Segment
POPA, POPAD	61	Pop All to GPR Words or Doublewords
PUSH CS	0E	Push CS Segment Selector onto Stack
PUSH DS	1E	Push DS Segment Selector onto Stack
PUSH ES	06	Push ES Segment Selector onto Stack
PUSH SS	16	Push SS Segment Selector onto Stack
PUSHA, PUSHAD	60	Push All GPR Words or Doublewords onto Stack
Redundant Grp1 (undocumented)	82	Redundant encoding of group1 Eb,lb opcodes
SALC (undocumented)	D6	Set AL According to CF

**Table 2-4. Invalid Instructions in Long Mode**

Mnemonic	Opcode (hex)	Description
SYSENTER	0F 34	System Call
SYSEXIT	0F 35	System Return

### 2.5.11 Reassigned Opcodes

Table 2-5 below lists opcodes that are assigned functions in 64-bit mode that differ from their legacy functions.

**Table 2-5. Opcodes Reassigned in 64-Bit Mode**

Opcode (hex)	Compatibility and Legacy Modes	64-Bit Mode
63	ARPL—Adjust Requestor Privilege Level	MOVSXD—Move Doubleword with Sign Extension
40–4F	DEC—Decrement by 1 INC—Increment by 1	REX Prefix
Note: Two-byte versions of DEC and INC are still available in 64-bit mode.		

### 2.5.12 FXSAVE and FXRSTOR Instructions

The FXSAVE and FXRSTOR instructions are used to save and restore the entire 128-bit media (XMM), 64-bit media, and x87 instruction-set environment during a context switch. The AMD64 architecture modifies the memory format used by these instructions in order to save and restore the full 64-bit instruction and data pointers, as well as the XMM8–15 registers. Selection of the 32-bit legacy format or the expanded 64-bit format is accomplished by using the corresponding operand size with the FXSAVE and FXRSTOR instructions. When 64-bit software executes an FXSAVE and FXRSTOR with a 32-bit operand size (no operand-size override) the 32-bit legacy format is used. When 64-bit software executes an FXSAVE and FXRSTOR with a 64-bit operand size, the 64-bit format is used.

For more information on the save area formats, see Section 11.4.4, “Saving Media and x87 Execution Unit State,” on page 308

If the fast-FXSAVE/FXRSTOR (FFXSR) feature is enabled in EFER, FXSAVE and FXRSTOR do not save or restore the XMM0–15 registers when executed in 64-bit mode at CPL 0. The x87 environment and MXCSR are saved whether fast-FXSAVE/FXRSTOR is enabled or not. The fast-FXSAVE/FXRSTOR feature has no effect on FXSAVE/FXRSTOR in non 64-bit mode or when CPL > 0.

Software can use the CPUID instruction to determine whether the fast-FXSAVE/FXRSTOR feature is available (CPUID Fn8000\_0001h\_EDX[FFXSR]). For information on using the CPUID instruction to obtain processor feature information, see Section 3.3, “Processor Feature Identification,” on page 63.

## 2.6 Interrupts and Exceptions

When a processor is running in long mode, an interrupt or exception causes the processor to enter 64-bit mode. All long-mode interrupt handlers must be implemented as 64-bit code. The AMD64 architecture expands the legacy interrupt-processing and exception-processing mechanism to support

handling of interrupts by 64-bit operating systems and applications. The changes are summarized in the following sections. See “Long-Mode Interrupt Control Transfers” on page 247 for detailed information on these changes.

### 2.6.1 Interrupt Descriptor Table

The long-mode interrupt-descriptor table (IDT) must contain 64-bit mode interrupt-gate or trap-gate descriptors for all interrupts or exceptions that can occur while the processor is running in long mode. Task gates cannot be used in the long-mode IDT, because control transfers through task gates are not supported in long mode. In long mode, the IDT index is formed by scaling the interrupt vector by 16. In legacy protected mode, the IDT is indexed by scaling the interrupt vector by eight.

### 2.6.2 Stack Frame Pushes

In legacy mode, the size of an IDT entry (16 bits or 32 bits) determines the size of interrupt-stack-frame pushes, and SS:eSP is pushed only on a CPL change. In long mode, the size of interrupt stack-frame pushes is fixed at eight bytes, because interrupts are handled in 64-bit mode. Long mode interrupts also cause SS:RSP to be pushed unconditionally, rather than pushing only on a CPL change.

### 2.6.3 Stack Switching

Legacy mode provides a mechanism to automatically switch stack frames in response to an interrupt. In long mode, a slightly modified version of the legacy stack-switching mechanism is implemented, and an alternative stack-switching mechanism—called the interrupt stack table (IST)—is supported.

**Long-Mode Stack Switches.** When stacks are switched as part of a long-mode privilege-level change resulting from an interrupt, the following occurs:

- The target-stack pointer read from the TSS is a 64-bit RSP value.
- The SS register is loaded with a null selector. Setting the new SS selector to null allows nested control transfers in 64-bit mode to be handled properly. The SS.RPL value is cleared to 0.
- The old SS and RSP are saved on the new stack.

**Interrupt Stack Table.** In long mode, a new interrupt stack table (IST) mechanism is available as an alternative to the modified legacy stack-switching mechanism. The IST mechanism unconditionally switches stacks when it is enabled. It can be enabled for individual interrupt vectors using a field in the IDT entry. This allows mixing interrupt vectors that use the modified legacy mechanism with vectors that use the IST mechanism. The IST pointers are stored in the long-mode TSS. The IST mechanism is only available when long mode is enabled.

### 2.6.4 IRET Instruction

In compatibility mode, IRET pops SS:eSP off the stack only if there is a CPL change. This allows legacy applications to run properly in compatibility mode when using the IRET instruction.

In 64-bit mode, IRET unconditionally pops SS:eSP off of the interrupt stack frame, even if the CPL does not change. This is done because the original interrupt always pushes SS:RSP. Because interrupt

stack-frame pushes are always eight bytes in long mode, an IRET from a long-mode interrupt handler (64-bit code) must pop eight-byte items off the stack. This is accomplished by preceding the IRET with a 64-bit REX operand-size prefix.

In long mode, an IRET can load a null SS selector from the stack under the following conditions:

- The target operating mode is 64-bit mode.
- The target  $CPL < 3$ .

Allowing IRET to load SS with a null selector under these conditions makes it possible for the processor to unnest interrupts (and far CALLs) in long mode.

### 2.6.5 Task-Priority Register (CR8)

The AMD64 architecture allows software to define up to 15 external interrupt-priority classes. Priority classes are numbered from 1 to 15, with priority-class 1 being the lowest and priority-class 15 the highest.

A new control register (CR8) is introduced by the AMD64 architecture for managing priority classes. This register, also called the *task-priority register* (TPR), uses the four low-order bits for specifying a task priority. How external interrupts are organized into these priority classes is implementation dependent. See “External Interrupt Priorities” on page 234 for information on this feature.

### 2.6.6 New Exception Conditions

The AMD64 architecture defines a number of new conditions that can cause an exception to occur when the processor is running in long mode. Many of the conditions occur when software attempts to use an address that is not in canonical form. See “Vectors” on page 214 for information on the new exception conditions that can occur in long mode.

## 2.7 Hardware Task Switching

The legacy hardware task-switch mechanism is disabled when the processor is running in long mode. However, long mode requires system software to create data structures for a single task—the long-mode task.

- *TSS Descriptors*—A new TSS-descriptor type, the 64-bit TSS type, is defined for use in long mode. It is the only valid TSS type that can be used in long mode, and it must be loaded into the TR by executing the LTR instruction in *64-bit mode*. See “TSS Descriptor” on page 330 for additional information.
- *Task Gates*—Because the legacy task-switch mechanism is not supported in long mode, *software cannot use task gates in long mode*. Any attempt to transfer control to another task through a task gate causes a general-protection exception (#GP) to occur.
- *Task-State Segment*—A 64-bit task state segment (TSS) is defined for use in long mode. This new TSS format contains 64-bit stack pointers (RSP) for privilege levels 0–2, interrupt-stack-table

(IST) pointers, and the I/O-map base address. See “64-Bit Task State Segment” on page 337 for additional information.

## 2.8 Long-Mode vs. Legacy-Mode Differences

Table 2-6 on page 39 summarizes several major system-programming differences between 64-bit mode and legacy protected mode. The third column indicates whether the difference also applies to compatibility mode. “Differences Between Long Mode and Legacy Mode” in Volume 3 summarizes the application-programming model differences.

**Table 2-6. Differences Between Long Mode and Legacy Mode**

Subject	64-Bit Mode Difference	Applies To Compatibility Mode?
x86 Modes	Real and virtual-8086 modes not supported	Yes
Task Switching	Task switching not supported	Yes
Addressing	64-bit virtual addresses	No
	4-level paging structures	Yes
	PAE must always be enabled	
Loaded Segment (Usage during memory reference)	CS, DS, ES, SS segment bases are ignored	No
	CS, DS, ES, FS, GS, SS segment limits are ignored	
	DS, ES, FS, GS attribute are ignored	
	CS, DS, ES, SS Segment prefixes are ignored	
Exception and Interrupt Handling	All pushes are 8 bytes	Yes
	IDT entries are expanded to 16 bytes	
	SS is not changed for stack switch	
	SS:RSP is pushed unconditionally	
Call Gates	All pushes are 8 bytes	Yes
	16-bit call gates are illegal	
	32-bit call gate type is redefined as 64-bit call gate and is expanded to 16 bytes	
	SS is not changed for stack switch	
System-Descriptor Registers	GDT, IDT, LDT, TR base registers expanded to 64 bits	Yes
System-Descriptor Table Entries and Pseudo-Descriptors	LGDT and LIDT use expanded 10-byte pseudo-descriptors	No
	LLDT and LTR use expanded 16-byte table entries	





## 3 System Resources

---

The operating system manages the software-execution environment and general system operation through the use of system resources. These resources consist of system registers (control registers and model-specific registers) and system-data structures (memory-management and protection tables). The system-control registers are described in detail in this chapter; many of the features they control are described elsewhere in this volume. The model-specific registers supported by the AMD64 architecture are introduced in this chapter.

Because of their complexity, system-data structures are described in separate chapters. Refer to the following chapters for detailed information on these data structures:

- Descriptors and descriptor tables are described in “Segmentation Data Structures and Registers” on page 67.
- Page-translation tables are described in “Legacy-Mode Page Translation” on page 122 and “Long-Mode Page Translation” on page 130.
- The task-state segment is described in “Legacy Task-State Segment” on page 333 and “64-Bit Task State Segment” on page 337.

Not all processor implementations are required to support all possible features. The last section in this chapter addresses processor-feature identification. System software uses the capabilities described in that section to determine which features are supported so that the appropriate service routines are loaded.

### 3.1 System-Control Registers

The registers that control the AMD64 architecture operating environment include:

- *CR0*—Provides operating-mode controls and some processor-feature controls.
- *CR2*—This register is used by the page-translation mechanism. It is loaded by the processor with the page-fault virtual address when a page-fault exception occurs.
- *CR3*—This register is also used by the page-translation mechanism. It contains the base address of the highest-level page-translation table, and also contains cache controls for the specified table.
- *CR4*—This register contains additional controls for various operating-mode features.
- *CR8*—This new register, accessible in 64-bit mode using the REX prefix, is introduced by the AMD64 architecture. CR8 is used to prioritize external interrupts and is referred to as the *task-priority register* (TPR).
- *RFLAGS*—This register contains processor-status and processor-control fields. The status and control fields are used primarily in the management of virtual-8086 mode, hardware multitasking, and interrupts.

- *EFER*—This model-specific register contains status and controls for additional features not managed by the CR0 and CR4 registers. Included in this register are the long-mode enable and activation controls introduced by the AMD64 architecture.

Control registers CR1, CR5–CR7, and CR9–CR15 are reserved.

In legacy mode, all control registers and RFLAGS are 32 bits. The EFER register is 64 bits in all modes. The AMD64 architecture expands all 32-bit system-control registers to 64 bits. In 64-bit mode, the MOV CR $n$  instructions read or write all 64 bits of these registers (operand-size prefixes are ignored). In compatibility and legacy modes, control-register writes fill the low 32 bits with data and the high 32 bits with zeros, and control-register reads return only the low 32 bits.

In 64-bit mode, the high 32 bits of CR0 and CR4 are reserved and must be written with zeros. Writing a 1 to any of the high 32 bits results in a general-protection exception, #GP(0). All 64 bits of CR2 are writable. However, the MOV CR $n$  instructions *do not* check that addresses written to CR2 are within the virtual-address limitations of the processor implementation.

All CR3 bits are writable, except for unimplemented physical address bits, which must be cleared to 0.

The upper 32 bits of RFLAGS are always read as zero by the processor. Attempts to load the upper 32 bits of RFLAGS with anything other than zero are ignored by the processor.

### 3.1.1 CR0 Register

The CR0 register is shown in Figure 3-1 on page 43. The legacy CR0 register is identical to the low 32 bits of this register (CR0 bits 31:0).

63										32										
Reserved, MBZ																				
31 30 29 28				19 18 17 16 15				6 5 4 3 2 1 0												
P	C	N	Reserved				A	R	W	Reserved				N	E	T	E	M	P	E
G	D	W					M		P					E	T	S	M	P	E	
Bits	Mnemonic	Description																		R/W
63:32	Reserved	Reserved, Must be Zero																		
31	PG	Paging																		R/W
30	CD	Cache Disable																		R/W
29	NW	Not Writethrough																		R/W
28:19	Reserved	Reserved																		
18	AM	Alignment Mask																		R/W
17	Reserved	Reserved																		
16	WP	Write Protect																		R/W
15:6	Reserved	Reserved																		
5	NE	Numeric Error																		R/W
4	ET	Extension Type																		R
3	TS	Task Switched																		R/W
2	EM	Emulation																		R/W
1	MP	Monitor Coprocessor																		R/W
0	PE	Protection Enabled																		R/W

**Figure 3-1. Control Register 0 (CR0)**

The functions of the CR0 control bits are (unless otherwise noted, all bits are read/write):

**Protected-Mode Enable (PE) Bit.** Bit 0. Software enables protected mode by setting PE to 1, and disables protected mode by clearing PE to 0. When the processor is running in protected mode, segment-protection mechanisms are enabled.

See “Segment-Protection Overview” on page 95 for information on the segment-protection mechanisms.

**Monitor Coprocessor (MP) Bit.** Bit 1. Software uses the MP bit with the task-switched control bit (CR0.TS) to control whether execution of the WAIT/FWAIT instruction causes a device-not-available exception (#NM) to occur, as follows:

- If both the monitor-coprocessor and task-switched bits are set (CR0.MP=1 *and* CR0.TS=1), then executing the WAIT/FWAIT instruction causes a device-not-available exception (#NM).
- If either the monitor-coprocessor or task-switched bits are clear (CR0.MP=0 *or* CR0.TS=0), then executing the WAIT/FWAIT instruction proceeds normally.

Software typically should set MP to 1 if the processor implementation supports x87 instructions. This allows the CR0.TS bit to completely control when the x87-instruction context is saved as a result of a task switch.

**Emulate Coprocessor (EM) Bit.** Bit 2. Software forces all x87 instructions to cause a device-not-available exception (#NM) by setting EM to 1. Likewise, setting EM to 1 forces an invalid-opcode exception (#UD) when an attempt is made to execute any of the 64-bit or 128-bit media instructions except the FXSAVE and FXRSTOR instructions. Attempting to execute these instructions when EM is set results in an #NM exception instead. The exception handlers can emulate these instruction types if desired. Setting the EM bit to 1 does not cause an #NM exception when the WAIT/FWAIT instruction is executed.

**Task Switched (TS) Bit.** Bit 3. When an attempt is made to execute an x87 or media instruction while TS=1, a device-not-available exception (#NM) occurs. Software can use this mechanism—sometimes referred to as “lazy context-switching”—to save the unit contexts before executing the next instruction of those types. As a result, the x87 and media instruction-unit contexts are saved only when necessary as a result of a task switch.

When a hardware task switch occurs, TS is automatically set to 1. System software that implements software task-switching rather than using the hardware task-switch mechanism can still use the TS bit to control x87 and media instruction-unit context saves. In this case, the task-management software uses a MOV CR0 instruction to explicitly set the TS bit to 1 during a task switch. Software can clear the TS bit by either executing the CLTS instruction or by writing to the CR0 register directly. Long-mode system software can use this approach even though the hardware task-switch mechanism is not supported in long mode.

The CR0.MP bit controls whether the WAIT/FWAIT instruction causes an #NM exception when TS=1.

**Extension Type (ET) Bit.** Bit 4, read-only. In some early x86 processors, software set ET to 1 to indicate support of the 387DX math-coprocessor instruction set. This bit is now reserved and forced to 1 by the processor. Software cannot clear this bit to 0.

**Numeric Error (NE) Bit.** Bit 5. Clearing the NE bit to 0 disables internal control of x87 floating-point exceptions and enables external control. When NE is cleared to 0, the IGNNE# input signal controls whether x87 floating-point exceptions are ignored:

- When IGNNE# is 1, x87 floating-point exceptions are ignored.
- When IGNNE# is 0, x87 floating-point exceptions are reported by setting the FERR# input signal to 1. External logic can use the FERR# signal as an external interrupt.

When NE is set to 1, internal control over x87 floating-point exception reporting is enabled and the external reporting mechanism is disabled. It is recommended that software set NE to 1. This enables optimal performance in handling x87 floating-point exceptions.

**Write Protect (WP) Bit.** Bit 16. Read-only pages are protected from supervisor-level writes when the WP bit is set to 1. When WP is cleared to 0, supervisor software can write into read-only pages.

See “Page-Protection Checks” on page 145 for information on the page-protection mechanism.

**Alignment Mask (AM) Bit.** Bit 18. Software enables automatic alignment checking by setting the AM bit to 1 when RFLAGS.AC=1. Alignment checking can be disabled by clearing either AM or RFLAGS.AC to 0. When automatic alignment checking is enabled and CPL=3, a memory reference to an unaligned operand causes an alignment-check exception (#AC).

**Not Writethrough (NW) Bit.** Bit 29. Ignored. This bit can be set to 1 or cleared to 0, but its value is ignored. The NW bit exists only for legacy purposes.

**Cache Disable (CD) Bit.** Bit 30. When CD is cleared to 0, the internal caches are enabled. When CD is set to 1, no new data or instructions are brought into the internal caches. However, the processor still accesses the internal caches when CD = 1 under the following situations:

- Reads that hit in an internal cache cause the data to be read from the internal cache that reported the hit.
- Writes that hit in an internal cache cause the cache line that reported the hit to be written back to memory and invalidated in the cache.

Cache misses do not affect the internal caches when CD = 1. Software can prevent cache access by setting CD to 1 and invalidating the caches.

Setting CD to 1 also causes the processor to ignore the page-level cache-control bits (PWT and PCD) when paging is enabled. These bits are located in the page-translation tables and CR3 register. See “Page-Level Writethrough (PWT) Bit” on page 139 and “Page-Level Cache Disable (PCD) Bit” on page 139 for information on page-level cache control.

See “Memory Caches” on page 179 for information on the internal caches.

**Paging Enable (PG) Bit.** Bit 31. Software enables page translation by setting PG to 1, and disables page translation by clearing PG to 0. Page translation cannot be enabled unless the processor is in protected mode (CR0.PE=1). If software attempts to set PG to 1 when PE is cleared to 0, the processor causes a general-protection exception (#GP).

See “Page Translation Overview” on page 118 for information on the page-translation mechanism.

**Reserved Bits.** Bits 28:19, 17, 15:6, and 63:32. When writing the CR0 register, software should set the values of reserved bits to the values found during the previous CR0 read. No attempt should be made to change reserved bits, and software should never rely on the values of reserved bits. In long mode, bits 63:32 are reserved and must be written with zero, otherwise a #GP occurs.

### 3.1.2 CR2 and CR3 Registers

The CR2 (page-fault linear address) register, shown in Figure 3-2 on page 46 and Figure 3-3 on page 46, and the CR3 (page-translation-table base address) register, shown in Figure 3-4 and Figure 3-5 on page 46, and Figure 3-6 on page 47, are used only by the page-translation mechanism.

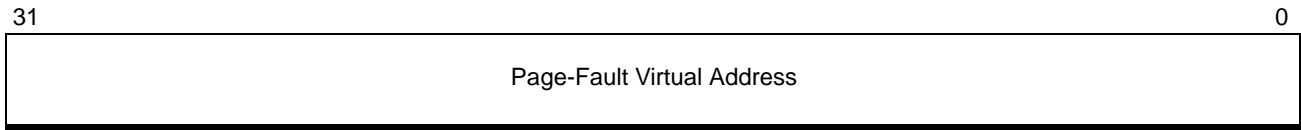

**Figure 3-2. Control Register 2 (CR2)—Legacy-Mode**

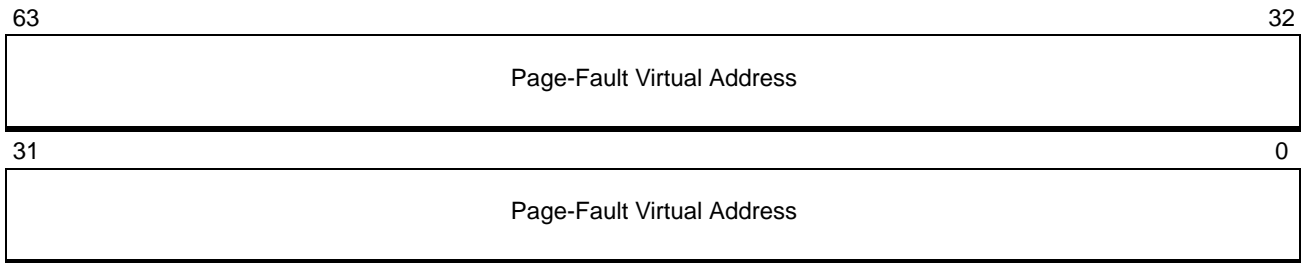

**Figure 3-3. Control Register 2 (CR2)—Long Mode**

See “CR2 Register” on page 226 for a description of the CR2 register.

The CR3 register is used to point to the base address of the highest-level page-translation table.

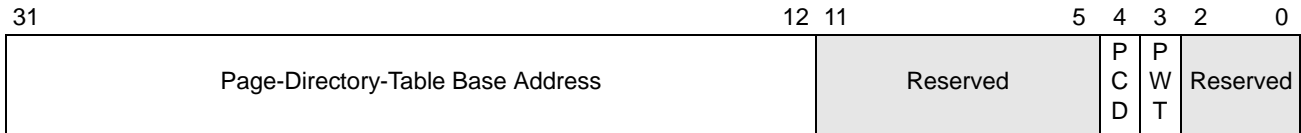

**Figure 3-4. Control Register 3 (CR3)—Legacy-Mode Non-PAE Paging**

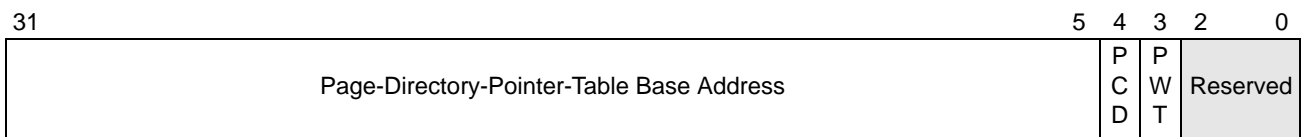

**Figure 3-5. Control Register 3 (CR3)—Legacy-Mode PAE Paging**

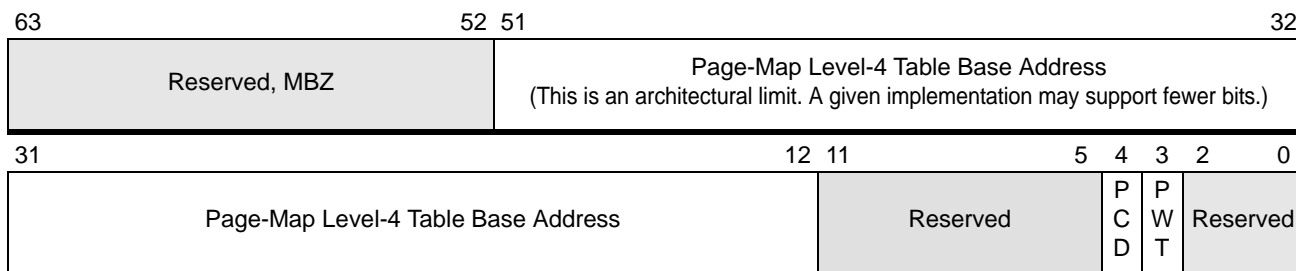
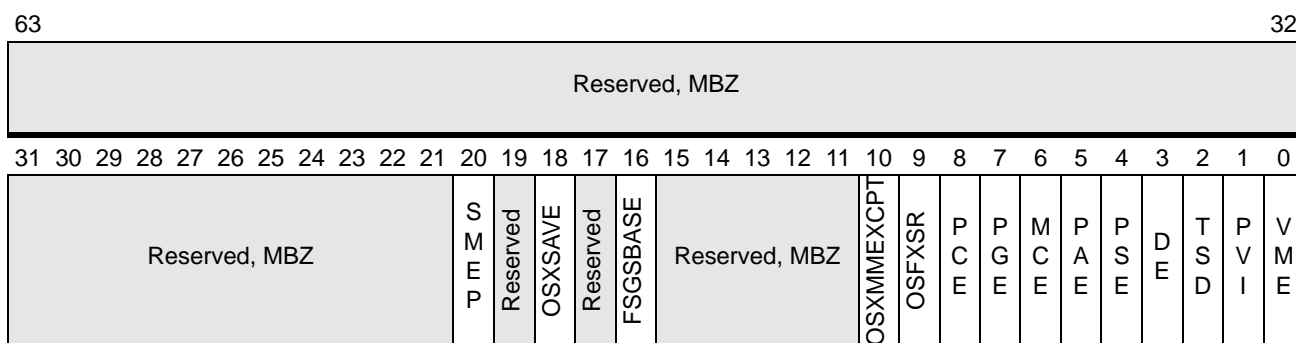

**Figure 3-6. Control Register 3 (CR3)—Long Mode**

The legacy CR3 register is described in “CR3 Register” on page 123, and the long-mode CR3 register is described in “CR3” on page 130.

### 3.1.3 CR4 Register

The CR4 register is shown in Figure 3-7. In legacy mode, the CR4 register is identical to the low 32 bits of the register (CR4 bits 31:0). The features controlled by the bits in the CR4 register are model-specific extensions. Except for the performance-counter extensions (PCE) feature, software can use the CPUID instruction to verify that each feature is supported before using that feature. See Section 3.3, “Processor Feature Identification,” on page 63 for information on using the CPUID instruction.



Bits	Mnemonic	Description	Access Type
63:19	—	Reserved	Reserved, MBZ
20	SMEP	Supervisor Mode Execution Prevention	R/W
19	—	Reserved	Reserved, MBZ
18	OSXSAVE	XSAVE and Processor Extended States Enable Bit	R/W
17	—	Reserved	Reserved, MBZ
16	FSGSBASE	Enable RDFSBASE, RDGSBASE, WRFSBASE, and WRGSBASE instructions	R/W
15:11	—	Reserved	Reserved, MBZ
10	OSXMMEXCPT	Operating System Unmasked Exception Support	R/W
9	OSFXSR	Operating System FXSAVE/FXRSTOR Support	R/W

Bits	Mnemonic	Description	Access Type
8	PCE	Performance-Monitoring Counter Enable	R/W
7	PGE	Page-Global Enable	R/W
6	MCE	Machine Check Enable	R/W
5	PAE	Physical-Address Extension	R/W
4	PSE	Page Size Extensions	R/W
3	DE	Debugging Extensions	R/W
2	TSD	Time Stamp Disable	R/W
1	PVI	Protected-Mode Virtual Interrupts	R/W
0	VME	Virtual-8086 Mode Extensions	R/W

:The function of the CR4 control bits are (all bits are read/write):

**Virtual-8086 Mode Extensions (VME).** Bit 0. Setting VME to 1 enables hardware-supported performance enhancements for software running in virtual-8086 mode. Clearing VME to 0 disables this support. The enhancements enabled when VME=1 include:

- Virtualized, maskable, external-interrupt control and notification using the VIF and VIP bits in the RFLAGS register. Virtualizing affects the operation of several instructions that manipulate the RFLAGS.IF bit.
- Selective intercept of software interrupts (INT $n$  instructions) using the interrupt-redirection bitmap in the TSS.

**Protected-Mode Virtual Interrupts (PVI).** Bit 1. Setting PVI to 1 enables support for protected-mode virtual interrupts. Clearing PVI to 0 disables this support. When PVI=1, hardware support of two bits in the RFLAGS register, VIF and VIP, is enabled.

Only the STI and CLI instructions are affected by enabling PVI. Unlike the case when CR0.VME=1, the interrupt-redirection bitmap in the TSS cannot be used for selective INT $n$  interception.

PVI enhancements are also supported in long mode. See “Virtual Interrupts” on page 253 for more information on using PVI.

**Time-Stamp Disable (TSD).** Bit 2. The TSD bit allows software to control the privilege level at which the time-stamp counter can be read. When TSD is cleared to 0, software running at any privilege level can read the time-stamp counter using the RDTSC or RDTSCP instructions. When TSD is set to 1, only software running at privilege-level 0 can execute the RDTSC or RDTSCP instructions.

**Debugging Extensions (DE).** Bit 3. Setting the DE bit to 1 enables the I/O breakpoint capability and enforces treatment of the DR4 and DR5 registers as reserved. Software that accesses DR4 or DR5 when DE=1 causes a invalid opcode exception (#UD).

When the DE bit is cleared to 0, I/O breakpoint capabilities are disabled. Software references to the DR4 and DR5 registers are aliased to the DR6 and DR7 registers, respectively.

**Page-Size Extensions (PSE).** Bit 4. Setting PSE to 1 enables the use of 4-Mbyte physical pages. With PSE=1, the physical-page size is selected between 4 Kbytes and 4 Mbytes using the page-



directory entry page-size field (PS). Clearing PSE to 0 disables the use of 4-Mbyte physical pages and restricts all physical pages to 4 Kbytes.

The PSE bit has no effect when physical-address extensions are enabled (CR4.PAE=1). Because long mode requires CR4.PAE=1, the PSE bit is ignored when the processor is running in long mode.

See “4-Mbyte Page Translation” on page 125 for more information on 4-Mbyte page translation.

**Physical-Address Extension (PAE).** Bit 5. Setting PAE to 1 enables the use of physical-address extensions and 2-Mbyte physical pages. Clearing PAE to 0 disables these features.

With PAE=1, the page-translation data structures are expanded from 32 bits to 64 bits, allowing the translation of up to 52-bit physical addresses. Also, the physical-page size is selectable between 4 Kbytes and 2 Mbytes using the page-directory-entry page-size field (PS). Long mode requires PAE to be enabled in order to use the 64-bit page-translation data structures to translate 64-bit virtual addresses to 52-bit physical addresses.

See “PAE Paging” on page 126 for more information on physical-address extensions.

**Machine-Check Enable (MCE).** Bit 6. Setting MCE to 1 enables the machine-check exception mechanism. Clearing this bit to 0 disables the mechanism. When enabled, a machine-check exception (#MC) occurs when an uncorrectable machine-check error is encountered.

Regardless of whether machine-check exceptions are enabled, the processor records enabled-errors when they occur. Error-reporting is performed by the machine-check error-reporting register banks. Each bank includes a control register for enabling error reporting and a status register for capturing errors. Correctable machine-check errors are also reported, but they do not cause a machine-check exception.

See Chapter 9, “Machine Check Architecture,” for a description of the machine-check mechanism, the registers used, and the types of errors captured by the mechanism.

**Page-Global Enable (PGE).** Bit 7. When page translation is enabled, system-software performance can often be improved by making some page translations *global* to all tasks and procedures. Setting PGE to 1 enables the global-page mechanism. Clearing this bit to 0 disables the mechanism.

When PGE is enabled, system software can set the global-page (G) bit in the lowest level of the page-translation hierarchy to 1, indicating that the page translation is global. Page translations marked as global are not invalidated in the TLB when the page-translation-table base address (CR3) is updated. When the G bit is cleared, the page translation is not global. All supported physical-page sizes also support the global-page mechanism. See “Global Pages” on page 142 for information on using the global-page mechanism.

**Performance-Monitoring Counter Enable (PCE).** Bit 8. Setting PCE to 1 allows software running at any privilege level to use the RDPMC instruction. Software uses the RDPMC instruction to read the performance-monitoring counter MSR, \*PerfCtrn. Clearing PCE to 0 allows only the most-privileged software (CPL=0) to use the RDPMC instruction.

**FXSAVE/FXRSTOR Support (OSFXSR).** Bit 9. System software must set the OSFXSR bit to 1 to enable use of the legacy SSE instructions. When this bit is set to 1, it also indicates that system software uses the FXSAVE and FXRSTOR instructions to save and restore the processor state for the x87, 64-bit media, and 128-bit media instructions.

Clearing the OSFXSR bit to 0 indicates that legacy SSE instructions cannot be used. Attempts to use those instructions while this bit is clear result in an invalid-opcode exception (#UD). Software can continue to use the FXSAVE/FXRSTOR instructions for saving and restoring the processor state for the x87 and 64-bit media instructions.

**Unmasked Exception Support (OSXMMEXCPT).** Bit 10. System software must set the OSXMMEXCPT bit to 1 when it supports the SIMD floating-point exception (#XF) for handling of unmasked 256-bit and 128-bit media floating-point errors. Clearing the OSXMMEXCPT bit to 0 indicates the #XF handler is not supported. When OSXMMEXCPT=0, unmasked 128-bit media floating-point exceptions cause an invalid-opcode exception (#UD). See “SIMD Floating-Point Exception Causes” in Volume 1 for more information on unmasked SSE floating-point exceptions.

**FSGSBASE.** Bit 16. System software must set this bit to 1 to enable the execution of the RDFSBASE, RDGSBASE, WRFSBASE, and WRGSBASE instructions when supported. When enabled, these instructions allow software running in 64-bit mode at any privilege level to read and write the FS.base and GS.base hidden segment register state. See the discussion of segment registers in 64-bit mode in Section 4.5.3, “Segment Registers in 64-Bit Mode,” on page 72. Also see descriptions of the RDFSBASE, RDGSBASE, WRFSBASE, and WRGSBASE instructions in Volume 3.

**XSAVE and Extended States (OSXSAVE).** Bit 18. After verifying hardware support for the extended processor state management instructions, operating system software sets this bit to indicate support for the XGETBV, XSAVE and XRSTOR instructions.

Setting this bit also:

- allows the execution of the XGETBV and XSETBV instructions, and
- enables the XSAVE and XRSTOR instructions to save and restore the x87 FPU state (including MMX registers), along with other processor extended states enabled in XCR0.

After initializing the XSAVE/XRSTOR save area, XSAVEOPT (if supported) may be used to save x87 FPU and other enabled extended processor state. For more information on XSAVEOPT, see individual instruction listing in Chapter 2 of Volume 4.

Note that legacy SSE instruction execution must be enabled prior to enabling extended processor state management.

**Supervisor Mode Execution Prevention (SMEP).** Bit 20. Setting this bit enables the supervisor mode execution prevention feature, if supported. This feature prevents the execution of instructions that reside in pages accessible by user-mode software when the processor is in supervisor-mode. See Section 5.6, “Page-Protection Checks,” on page 145 for more information.

**CR1 and CR5–CR7 Registers.** Control registers CR1, CR5–CR7, and CR9–CR15 are reserved. Attempts by software to use these registers result in an undefined-opcode exception (#UD).

### 3.1.4 Additional Control Registers in 64-Bit-Mode

In 64-bit mode, additional encodings are available to address up to eight additional control registers. The REX.R bit, in a REX prefix, is used to modify the ModRM *reg* field when that field encodes a control register, as shown in “REX Prefixes” in Volume 3. These additional encodings enable the processor to address CR8–CR15.

One additional control register, CR8, is defined in 64-bit mode for all hardware implementations, as described in “CR8 (Task Priority Register, TPR),” below. Access to the CR9–CR15 registers is implementation-dependent. Any attempt to access an unimplemented register results in an invalid-opcode exception (#UD).

### 3.1.5 CR8 (Task Priority Register, TPR)

The AMD64 architecture introduces a new control register, CR8, defined as the task priority register (TPR). The register is accessible in 64-bit mode using the REX prefix. See “External Interrupt Priorities” on page 234 for a description of the TPR and how system software can use the TPR for controlling external interrupts.

### 3.1.6 RFLAGS Register

The RFLAGS register contains two different types of information:

- *Control bits* provide system-software controls and directional information for string operations. Some of these bits can have privilege-level restrictions.
- *Status bits* provide information resulting from logical and arithmetic operations. These are written by the processor and can be read by software running at any privilege level.

Figure 3-8 on page 52 shows the format of the RFLAGS register. The legacy EFLAGS register is identical to the low 32 bits of the register shown in Figure 3-8 (RFLAGS bits 31:0). The term *rFLAGS* is used to refer to the 16-bit, 32-bit, or 64-bit flags register, depending on context.

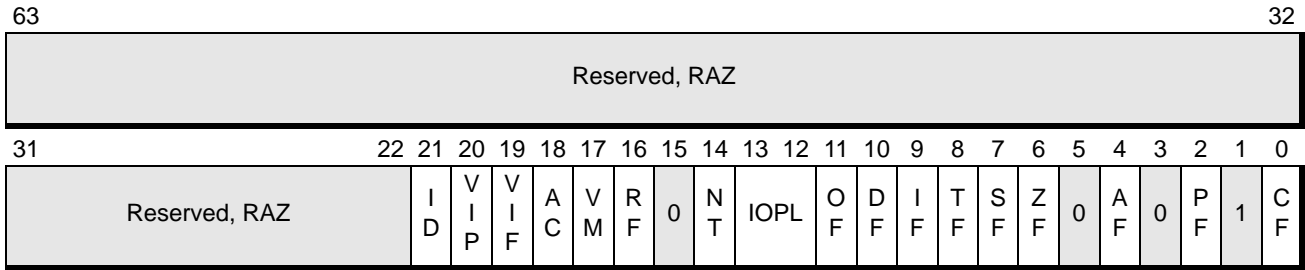

Bits	Mnemonic	Description	R/W
63:22	Reserved	Reserved, Read as Zero	
21	ID	ID Flag	R/W
20	VIP	Virtual Interrupt Pending	R/W
19	VIF	Virtual Interrupt Flag	R/W
18	AC	Alignment Check	R/W
17	VM	Virtual-8086 Mode	R/W
16	RF	Resume Flag	R/W
15	Reserved	Reserved, Read as Zero	
14	NT	Nested Task	R/W
13:12	IOPL	I/O Privilege Level	R/W
11	OF	Overflow Flag	R/W
10	DF	Direction Flag	R/W
9	IF	Interrupt Flag	R/W
8	TF	Trap Flag	R/W
7	SF	Sign Flag	R/W
6	ZF	Zero Flag	R/W
5	Reserved	Reserved, Read as Zero	
4	AF	Auxiliary Flag	R/W
3	Reserved	Reserved, Read as Zero	
2	PF	Parity Flag	R/W
1	Reserved	Reserved, Read as One	
0	CF	Carry Flag	R/W

Figure 3-7. RFLAGS Register

The functions of the RFLAGS control and status bits used by application software are described in “Flags Register” in Volume 1. The functions of RFLAGS system bits are (unless otherwise noted, all bits are read/write):

**Trap Flag (TF) Bit.** Bit 8. Software sets the TF bit to 1 to enable single-step mode during software debug. Clearing this bit to 0 disables single-step mode.

When single-step mode is enabled, a debug exception (#DB) occurs after each instruction completes execution. Single stepping begins with the instruction *following* the instruction that sets TF. Single stepping is disabled (TF=0) when the #DB exception occurs or when any exception or interrupt occurs.

See “Single Stepping” on page 360 for information on using the single-step mode during debugging.

**Interrupt Flag (IF) Bit.** Bit 9. Software sets the IF bit to 1 to enable maskable interrupts. Clearing this bit to 0 causes the processor to ignore maskable interrupts. The state of the IF bit does not affect the response of a processor to non-maskable interrupts, software-interrupt instructions, or exceptions.

The ability to modify the IF bit depends on several factors:

- The current privilege-level (CPL)
- The I/O privilege level (RFLAGS.IOPL)
- Whether or not virtual-8086 mode extensions are enabled (CR4.VME=1)
- Whether or not protected-mode virtual interrupts are enabled (CR4.PVI=1)

See “Masking External Interrupts” on page 213 for information on interrupt masking. See “Accessing the RFLAGS Register” on page 156 for information on the specific instructions used to modify the IF bit.

**I/O Privilege Level Field (IOPL) Field.** Bits 13:12. The IOPL field specifies the privilege level required to execute I/O address-space instructions (i.e., instructions that address the I/O space rather than memory-mapped I/O, such as IN, OUT, INS, OUTS, etc.). For software to execute these instructions, the current privilege-level (CPL) must be equal to or higher than (lower numerical value than) the privilege specified by IOPL ( $CPL \leq IOPL$ ). If the CPL is lower than (higher numerical value than) that specified by the IOPL ( $CPL > IOPL$ ), the processor causes a general-protection exception (#GP) when software attempts to execute an I/O instruction. See “Protected-Mode I/O” in Volume 1 for information on how IOPL controls access to address-space I/O.

Virtual-8086 mode uses IOPL to control virtual interrupts and the IF bit when virtual-8086 mode extensions are enabled (CR4.VME=1). The protected-mode virtual-interrupt mechanism (PVI) also uses IOPL to control virtual interrupts and the IF bit when PVI is enabled (CR4.PVI=1). See “Virtual Interrupts” on page 253 for information on how IOPL is used by the virtual interrupt mechanism.

**Nested Task (NT) Bit.** Bit 14. IRET reads the NT bit to determine whether the current task is nested within another task. When NT is set to 1, the current task is nested within another task. When NT is cleared to 0, the current task is at the top level (not nested).

The processor sets the NT bit during a task switch resulting from a CALL, interrupt, or exception through a task gate. When an IRET is executed from legacy mode while the NT bit is set, a task switch occurs. See “Task Switches Using Task Gates” on page 343 for information on switching tasks using task gates, and “Nesting Tasks” on page 345 for information on task nesting.

**Resume Flag (RF) Bit.** Bit 16. The RF bit allows an instruction to be restarted following an instruction breakpoint resulting in a debug exception (#DB). This bit prevents multiple debug exceptions from occurring on the same instruction.

The processor clears the RF bit after every instruction is successfully executed, except when the instruction is:

- An IRET that sets the RF bit.
- JMP, CALL, or INT $n$  through a task gate.

In both of the above cases, RF is not cleared to 0 until the *next* instruction successfully executes.

When an exception occurs (or when a string instruction is interrupted), the processor normally sets RF=1 in the RFLAGS image saved on the interrupt stack. However, when a #DB exception occurs as a result of an instruction breakpoint, the processor clears the RF bit to 0 in the interrupt-stack RFLAGS image.

For instruction restart to work properly following an instruction breakpoint, the #DB exception handler must set RF to 1 in the interrupt-stack RFLAGS image. When an IRET is later executed to return to the instruction that caused the instruction-breakpoint #DB exception, the set RF bit (RF=1) is loaded from the interrupt-stack RFLAGS image. RF is not cleared by the processor until the instruction causing the #DB exception successfully executes.

**Virtual-8086 Mode (VM) Bit.** Bit 17. Software sets the VM bit to 1 to enable virtual-8086 mode. Software clears the VM bit to 0 to disable virtual-8086 mode. System software can only change this bit using a task switch or an IRET. It cannot modify the bit using the POPFD instruction.

**Alignment Check (AC) Bit.** Bit 18. Software enables automatic alignment checking by setting the AC bit to 1 when CR0.AM=1. Alignment checking can be disabled by clearing either AC or CR0.AM to 0. When automatic alignment checking is enabled and the current privilege-level (CPL) is 3 (least privileged), a memory reference to an unaligned operand causes an alignment-check exception (#AC).

**Virtual Interrupt (VIF) Bit.** Bit 19. The VIF bit is a virtual image of the RFLAGS.IF bit. It is enabled when either virtual-8086 mode extensions are enabled (CR4.VME=1) or protected-mode virtual interrupts are enabled (CR4.PVI=1), and the RFLAGS.IOPL field is less than 3. When enabled, instructions that ordinarily would modify the IF bit actually modify the VIF bit with no effect on the RFLAGS.IF bit.

System software that supports virtual-8086 mode should enable the VIF bit using CR4.VME. This allows 8086 software to execute instructions that can set and clear the RFLAGS.IF bit without causing an exception. With VIF enabled in virtual-8086 mode, those instructions set and clear the VIF bit instead, giving the appearance to the 8086 software that it is modifying the RFLAGS.IF bit. System software reads the VIF bit to determine whether or not to take the action desired by the 8086 software (enabling or disabling interrupts by setting or clearing the RFLAGS.IF bit).

In long mode, the use of the VIF bit is supported when CR4.PVI=1. See “Virtual Interrupts” on page 253 for more information on virtual interrupts.

**Virtual Interrupt Pending (VIP) Bit.** Bit 20. The VIP bit is provided as an extension to both virtual-8086 mode and protected mode. It is used by system software to indicate that an external, maskable interrupt is pending (awaiting) execution by either a virtual-8086 mode or protected-mode interrupt-service routine. Software must enable virtual-8086 mode extensions (CR4.VME=1) or protected-mode virtual interrupts (CR4.PVI=1) before using VIP.

VIP is normally set to 1 by a protected-mode interrupt-service routine that was entered from virtual-8086 mode as a result of an external, maskable interrupt. Before returning to the virtual-8086 mode application, the service routine sets VIP to 1 if EFLAGS.VIF=1. When the virtual-8086 mode application attempts to enable interrupts by clearing EFLAGS.VIF to 0 while VIP=1, a general-protection exception (#GP) occurs. The #GP service routine can then decide whether to allow the virtual-8086 mode service routine to handle the pending external, maskable interrupt. (EFLAGS is specifically referred to in this case because virtual-8086 mode is supported only from legacy mode.)

In long mode, the use of the VIP bit is supported when CR4.PVI=1. See “Virtual Interrupts” on page 253 for more information on virtual-8086 mode interrupts and the VIP bit.

**Processor Feature Identification (ID) Bit.** Bit 21. The ability of software to modify this bit indicates that the processor implementation supports the CPUID instruction. See Section 3.3, “Processor Feature Identification,” on page 63 for more information on the CPUID instruction.

### 3.1.7 Extended Feature Enable Register (EFER)

The extended-feature-enable register (EFER) contains control bits that enable additional processor features not controlled by the legacy control registers. The EFER is a model-specific register (MSR) with an address of C000\_0080h (see “Model-Specific Registers (MSRs)” on page 58 for more information on MSRs). It can be read and written only by privileged software. Figure 3-9 on page 56 shows the format of the EFER register.

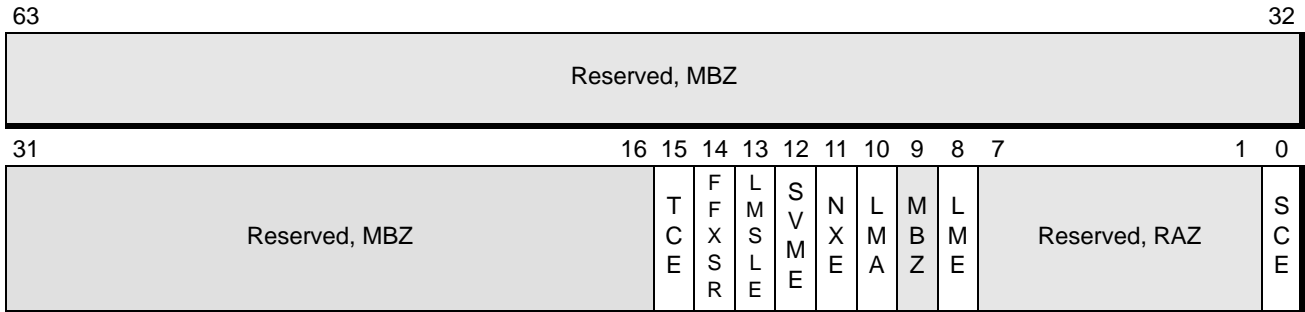

Bits	Mnemonic	Description	R/W
63:16	Reserved, MBZ	Reserved, Must be Zero	
15	TCE	Translation Cache Extension	R/W
14	FFXSR	Fast FXSAVE/FXRSTOR	R/W
13	LMSLE	Long Mode Segment Limit Enable	R/W
12	SVME	Secure Virtual Machine Enable	R/W
11	NXE	No-Execute Enable	R/W
10	LMA	Long Mode Active	R/W
9	Reserved, MBZ	Reserved, Must be Zero	
8	LME	Long Mode Enable	R/W
7:1	Reserved, RAZ	Reserved, Read as Zero	
0	SCE	System Call Extensions	R/W

**Figure 3-8. Extended Feature Enable Register (EFER)**

The defined EFER bits shown in Figure 3-9 above are described below:

**System-Call Extension (SCE) Bit.** Bit 0, read/write. Setting this bit to 1 enables the SYSCALL and SYSRET instructions. Application software can use these instructions for low-latency system calls and returns in a non-segmented (flat) address space. See “Fast System Call and Return” on page 152 for additional information.

**Long Mode Enable (LME) Bit.** Bit 8, read/write. Setting this bit to 1 enables the processor to activate long mode. Long mode is not activated until software enables paging some time later. When paging is enabled after LME is set to 1, the processor sets the EFER.LMA bit to 1, indicating that long mode is not only enabled but also active. See Chapter 14, “Processor Initialization and Long Mode Activation,” for more information on activating long mode.

**Long Mode Active (LMA) Bit.** Bit 10, read/write. This bit indicates that long mode is active. The processor sets LMA to 1 when both long mode and paging have been enabled by system software. See Chapter 14, “Processor Initialization and Long Mode Activation,” for more information on activating long mode.

When LMA=1, the processor is running either in compatibility mode or 64-bit mode, depending on the value of the L bit in a code-segment descriptor, as shown in Figure 1-6 on page 12.



When LMA=0, the processor is running in legacy mode. In this mode, the processor behaves like a standard 32-bit x86 processor, with none of the new 64-bit features enabled. When writing the EFER register the value of this bit must be preserved. Software must read the EFER register to determine the value of LMA, change any other bits as required and then write the EFER register. An attempt to write a value that differs from the state determined by hardware results in a #GP fault.

**No-Execute Enable (NXE) Bit.** Bit 11, read/write. Setting this bit to 1 enables the no-execute page-protection feature. The feature is disabled when this bit is cleared to 0. See “No Execute (NX) Bit” on page 140 for more information.

Before setting NXE, system software should verify the processor supports the feature by examining the feature flag CPUID Fn8000\_0001\_EDX[NX]. See Section 3.3, “Processor Feature Identification,” on page 63 for information on using the CPUID instruction.

**Secure Virtual Machine Enable (SVME) Bit.** Bit 12, read/write. Enables the SVM extensions. When this bit is zero, the SVM instructions cause #UD exceptions. EFER.SVME defaults to a reset value of zero. The effect of turning off EFER.SVME while a guest is running is undefined; therefore, the VMM should always prevent guests from writing EFER. SVM extensions can be disabled by setting VM\_CR.SVME\_DISABLE. For more information, see descriptions of LOCK and SMVE\_DISABLE bits in Section 15.30.1, “VM\_CR MSR (C001\_0114h),” on page 524.

**Long Mode Segment Limit Enable (LMSLE) bit.** Bit 13, read/write. Setting this bit to 1 enables certain limit checks in 64-bit mode. See Section 4.12.2, “Data Limit Checks in 64-bit Mode”, for more information on these limit checks.

**Fast FXSAVE/FXRSTOR (FFXSR) Bit.** Bit 14, read/write. Setting this bit to 1 enables the FXSAVE and FXRSTOR instructions to execute faster in 64-bit mode at CPL 0. This is accomplished by not saving or restoring the XMM registers (XMM0-XMM15). The FFXSR bit has no effect when the FXSAVE/FXRSTOR instructions are executed in non 64-bit mode, or when CPL > 0. The FFXSR bit does not affect the save/restore of the legacy x87 floating-point state, or the save/restore of MXCSR.

Before setting FFXSR, system software should verify whether this feature is supported by examining the feature flag CPUID Fn8000\_0001\_EDX[FFXSR]. See Section 3.3, “Processor Feature Identification,” on page 63 for information on using the CPUID instruction.

**Translation Cache Extension (TCE) Bit.** Bit 15, read/write. Setting this bit to 1 changes how the INVLPG instruction operates on TLB entries. When this bit is 0, INVLPG will remove the target PTE from the TLB as well as *all* upper-level table entries that are cached in the TLB, whether or not they are associated with the target PTE. When this bit is set, INVLPG will remove the target PTE and only those upper-level entries that lead to the target PTE in the page table hierarchy, leaving unrelated upper-level entries intact. This may provide a performance benefit.

Page table management software must be written in a way that takes this behavior into account. Software that was written for a processor that does not cache upper-level table entries may result in stale entries being incorrectly used for translations when TCE is enabled. Software that is compatible with TCE mode will operate in either mode.

Before setting TCE, system software should verify that this feature is supported by examining the feature flag CPUID Fn8000\_0001\_ECX[TCE]. See Section 3.3, “Processor Feature Identification,” on page 63 for information on using the CPUID instruction.

### 3.1.8 Extended Control Registers (XCR $n$ )

Extended control registers (XCR $n$ ) form a new register space that is available for managing processor architectural features and capabilities. Currently only XCR0 is defined. All other XCR registers are reserved. For more details on the Extended Control Registers, see “Extended Control Registers” in Volume 4, Chapter 1.

## 3.2 Model-Specific Registers (MSRs)

Processor implementations provide model-specific registers (MSRs) for software control over the unique features supported by that implementation. Software reads and writes MSRs using the privileged RDMSR and WRMSR instructions. Implementations of the AMD64 architecture can contain a mixture of two basic MSR types:

- *Legacy MSRs.* The AMD family of processors often share model-specific features with other x86 processor implementations. Where possible, AMD implementations use the same MSRs for the same functions. For example, the memory-typing and debug-extension MSRs are implemented on many AMD and non-AMD processors.
- *AMD model-specific MSRs.* There are many MSRs common to the AMD family of processors but not to legacy x86 processors. Where possible, AMD implementations use the same AMD-specific MSRs for the same functions.

Every model-specific register, as the name implies, is not necessarily implemented by all members of the AMD family of processors. Appendix A, “MSR Cross-Reference,” lists MSR-address ranges currently used by various AMD and other x86 processors.

The AMD64 architecture includes a number of features that are controlled using MSRs. Those MSRs are shown in Figure 3-10. The EFER register—described in “Extended Feature Enable Register (EFER)” on page 55—is also an MSR.

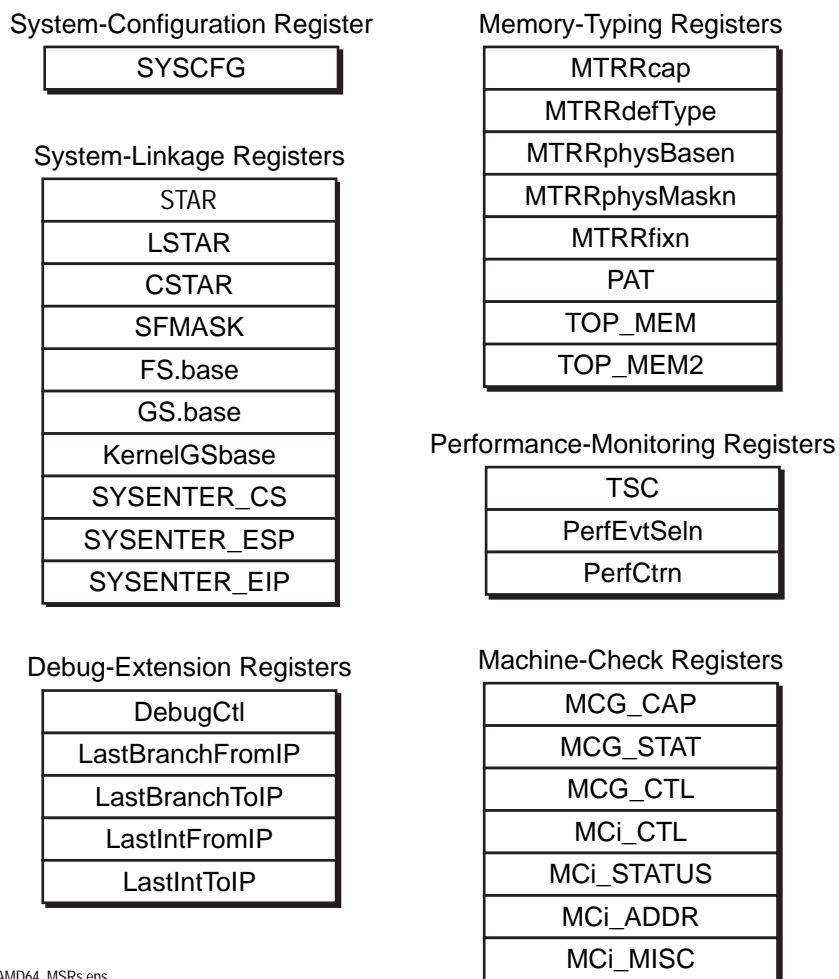

AMD64\_MSRS.eps

**Figure 3-9. AMD64 Architecture Model-Specific Registers**

The following sections briefly describe the MSRs in the AMD64 architecture.

### 3.2.1 System Configuration Register (SYSCFG)

The system-configuration register (SYSCFG) contains control bits for enabling and configuring system bus features. SYSCFG is a model-specific register (MSR) with an address of C001\_0010h. Figure 3-11 on page 60 shows the format of the SYSCFG register. Some features are implementation specific, and are described in the *BIOS and Kernel Developer's Guide* applicable to your product. Implementation-specific features are not shown in Figure 3-11.



### 3.2.2 System-Linkage Registers

System-linkage MSR are used by system software to allow fast control transfers between applications and the operating system. The functions of these registers are:

**STAR, LSTAR, CSTAR, and SFMASK Registers.** These registers are used to provide mode-dependent linkage information for the SYSCALL and SYSRET instructions. STAR is used in legacy modes, LSTAR in 64-bit mode, and CSTAR in compatibility mode. SFMASK is used by the SYSCALL instruction for RFLAGS in long mode.

**FS.base and GS.base Registers.** These registers allow 64-bit base-address values to be specified for the FS and GS segments, for use in 64-bit mode. See “FS and GS Registers in 64-Bit Mode” on page 72 for a description of the special treatment the FS and GS segments receive.

**KernelGSbase Register.** This register is used by the SWAPGS instruction. This instruction exchanges the value located in KernelGSbase with the value located in GS.base.

**SYSENTERx Registers.** The SYSENTER\_CS, SYSENTER\_ESP, and SYSENTER\_EIP registers are used to provide linkage information for the SYSENTER and SYSEXIT instructions. These instructions are only used in legacy mode.

The system-linkage instructions and their use of MSRs are described in “Fast System Call and Return” on page 152.

### 3.2.3 Memory-Typing Registers

Memory-typing MSRs are used to characterize, or type, memory. Memory typing allows software to control the cacheability of memory, and determine how accesses to memory are ordered. The memory-typing registers perform the following functions:

**MTRRcap Register.** This register contains information describing the level of MTRR support provided by the processor.

**MTRRdefType Register.** This register establishes the default memory type to be used for physical memory that is not specifically characterized using the fixed-range and variable-range MTRRs.

**MTRRphysBasen and MTRRphysMaskn Registers.** These registers form a register pair that can be used to characterize any address range within the physical-memory space, including all of physical memory. Up to eight address ranges of varying sizes can be characterized using these registers.

**MTRRfixn Registers.** These registers are used to characterize fixed-size memory ranges in the first 1 Mbytes of physical-memory space.

**PAT Register.** This register allows memory-type characterization based on the virtual (linear) address. It is an extension to the PCD and PWT memory types supported by the legacy paging mechanism. The PAT mechanism provides the same memory-typing capabilities as the MTRRs, but with the added flexibility provided by the paging mechanism.

**TOP\_MEM and TOP\_MEM2 Registers.** These top-of-memory registers allow system software to specify physical addresses ranges as memory-mapped I/O locations.

Refer to “Memory-Type Range Registers” on page 187 for more information on using these registers.

### 3.2.4 Debug-Extension Registers

The debug-extension MSR registers provide software-debug capability not available in the legacy debug registers (DR0–DR7). These MSR registers allow single stepping and recording of control transfers to take place. The debug-extension registers perform the following functions:

**DebugCtl Register.** This MSR register provides control over control-transfer recording and single stepping, and external-breakpoint reporting and trace messages.

**LastBranchx and LastIntx Registers.** The four registers, LastBranchToIP, LastBranchFromIP, LastIntToIP, and LastIntFromIP, are all used to record the source and target of control transfers when branch recording is enabled.

Refer to “Control-Transfer Breakpoint Features” on page 360 for more information on using these debug registers.

### 3.2.5 Performance-Monitoring Registers

The time-stamp counter and performance-monitoring registers are useful in identifying performance bottlenecks. The number of performance counters can vary based on the implementation. These registers perform the following functions:

**TSC Register.** This register is used to count processor-clock cycles. It can be read using the RDMSR instruction, or it can be read using either of the *read time-stamp counter* instructions, RDTSC or RDTSCP. System software can make RDTSC or RDTSCP available for use by non-privileged software by clearing the time-stamp disable bit (CR4.TSD) to 0.

**\*PerfEvtSel $n$  Registers.** These registers are used to specify the events counted by the corresponding performance counter, and to control other aspects of its operation.

**\*PerfCtr $n$  Registers.** These registers are performance counters that hold a count of processor, northbridge, or L2 cache events or the duration of events, under the control of the corresponding \*PerfEvtSel $n$  register. Each \*PerfCtr $n$  register can be read using the RDMSR instruction, or they can be read using the *read performance-monitor counter* instruction, RDPMC. System software can make RDPMC available for use by non-privileged software by setting the performance-monitor counter enable bit (CR4.PCE) to 1.

Refer to “Using Performance Counters” on page 369 for more information on using these registers.

### 3.2.6 Machine-Check Registers

The machine-check registers control the detection and reporting of hardware machine-check errors. The types of errors that can be reported include cache-access errors, load-data and store-data errors,

bus-parity errors, and ECC errors. Two types of machine-check MSR are shown in Figure 3-10 on page 59.

The first type is global machine-check registers, which perform the following functions:

**MCG\_CAP Register.** This register identifies the machine-check capabilities supported by the processor.

**MCG\_CTL Register.** This register provides global control over machine-check-error reporting.

**MCG\_STATUS Register.** This register reports global status on detected machine-check errors.

The second type is error-reporting register banks, which report on machine-check errors associated with a specific processor unit (or group of processor units). There can be different numbers of register banks for each processor implementation, and each bank is numbered from 0 to *i*. The registers in each bank perform the following functions:

**MCi\_CTL Registers.** These registers control error-reporting.

**MCi\_STATUS Registers.** These registers report machine-check errors.

**MCi\_ADDR Registers.** These registers report the machine-check error address.

**MCi\_MISC Registers.** These registers report miscellaneous-error information.

Refer to “Using MCA Features” on page 278 for more information on using these registers.

### 3.3 Processor Feature Identification

The CPUID instruction provides information about the processor implementation and its capabilities. Software operating at any privilege level can execute the CPUID instruction to collect this information. Software can utilize this information to optimize performance.

The CPUID instruction supports multiple functions, each providing specific information about the processor implementation, including the vendor, model number, revision (stepping), features, cache organization, and name. The multifunction approach allows the CPUID instruction to return a detailed picture of the processor implementation and its capabilities—more detailed information than could be returned by a single function. This flexibility also allows for the addition of new CPUID functions in future processor generations.

The desired function number is loaded into the EAX register before executing the CPUID instruction. CPUID functions are divided into two types:

- *Standard functions* return information about features common to all x86 implementations, including the earliest features offered in the x86 architecture, as well as information about the presence of features such as support for the AVX and FMA instruction subsets. Standard function numbers are in the range 0000\_0000h–0000\_FFFFh.

- *Extended functions* return information about AMD-specific features such as long mode and the presence of features such as support for the FMA4 and XOP instruction subsets. Extended function numbers are in the range 8000\_0000h–8000\_FFFFh.

Feature information is returned in the EAX, EBX, ECX, and EDX registers. Some functions accept a second input parameter passed to the instruction in the ECX register.

In this and the other three volumes of this *Programmer's Manual*, the notation *CPUID FnXXXX\_XXXX\_RRR[FieldName]\_xYY* is used to represent the input parameters and return value that corresponds to a particular processor capability or feature.

In this notation, *XXXX\_XXXX* represents the 32-bit value to be placed in the EAX register prior to executing the CPUID instruction. This value is the function number. *RRR* is either EAX, EBX, ECX, or EDX and represents the register to be examined after the execution of the instruction. If the contents of the entire 32-bit register provides the capability information, the notation *[FieldName]* is omitted, otherwise this provides the name of the field within the return value that represents the capability or feature.

When the field is a single bit, this is called a feature flag. Normally, if a feature flag bit is set, the corresponding processor feature is supported and if it is cleared, the feature is not supported. The optional input parameter passed to the CPUID instruction in the ECX register is represented by the notation *\_xYY* appended after the return value notation. If a CPUID function does not accept this optional input parameter, this notation is omitted.

For more specific information on the CPUID instruction, see the instruction reference page in Volume 3. For a description of all feature flags related to instruction subset support, see Volume 3, Appendix D, "Instruction Subsets and CPUID Feature Flags." For a comprehensive list of all processor capabilities and feature flags, see Volume 3, Appendix E, "Obtaining Processor Information Via the CPUID Instruction."



## 4 Segmented Virtual Memory

---

The legacy x86 architecture supports a segment-translation mechanism that allows system software to relocate and isolate instructions and data anywhere in the virtual-memory space. A segment is a contiguous block of memory within the linear address space. The size and location of a segment within the linear address space is arbitrary. Instructions and data can be assigned to one or more memory segments, each with its own protection characteristics. The processor hardware enforces the rules dictating whether one segment can access another segment.

The segmentation mechanism provides ten segment registers, each of which defines a single segment. Six of these registers (CS, DS, ES, FS, GS, and SS) define user segments. User segments hold software, data, and the stack and can be used by both application software and system software. The remaining four segment registers (GDT, LDT, IDT, and TR) define system segments. System segments contain data structures initialized and used only by system software. Segment registers contain a *base address* pointing to the starting location of a segment, a *limit* defining the segment size, and *attributes* defining the segment-protection characteristics.

Although segmentation provides a great deal of flexibility in relocating and protecting software and data, it is often more efficient to handle memory isolation and relocation with a combination of software and hardware paging support. For this reason, most modern system software bypasses the segmentation features. However, segmentation cannot be completely disabled, and an understanding of the segmentation mechanism is important to implementing long-mode system software.

In long mode, the effects of segmentation depend on whether the processor is running in compatibility mode or 64-bit mode:

- In compatibility mode, segmentation functions just as it does in legacy mode, using legacy 16-bit or 32-bit protected mode semantics.
- 64-bit mode, segmentation is disabled, creating a flat 64-bit virtual-address space. As will be seen, certain functions of some segment registers, particularly the system-segment registers, continue to be used in 64-bit mode.

### 4.1 Real Mode Segmentation

After reset or power-up, the processor always initially enters real mode. Protected modes are entered from real mode.

As noted in “Real Addressing” on page 10, real mode (real-address mode), provides a physical-memory space of 1 Mbyte. In this mode, a 20-bit physical address is determined by shifting a 16-bit segment selector to the left four bits and adding the 16-bit effective address.

Each 64K segment (CS, DS, ES, FS, GS, SS) is aligned on 16-byte boundaries. The *segment base* is the lowest address in a given segment, and is equal to the segment selector \* 16. The POP and MOV instructions can be used to load a (possibly) new segment selector into one of the segment registers.

When this occurs, the selector is updated and the selector base is set to selector \* 16. The segment limit and segment attributes are unchanged, but are normally 64K (the maximum allowable limit) and read/write data, respectively.

On FAR transfers, CS (code segment) selector is updated to the new value, and the CS segment base is set to selector \* 16. The CS segment limit and attributes are unchanged, but are usually 64K and read/write, respectively.

If the interrupt descriptor table (IDT) is used to find the real mode IDT see “Real-Mode Interrupt Control Transfers” on page 235.

The GDT, LDT, and TSS (see below) are not used in real mode.

## 4.2 Virtual-8086 Mode Segmentation

Virtual-8086 mode supports 16-bit real mode programs running under protected mode (see below). It uses a simple form of memory segmentation, optional paging, and limited protection checking. Programs running in virtual-8086 mode can access up to 1MB of memory space.

As with real mode segmentation, each 64K segment (CS, DS, ES, FS, GS, SS) is aligned on 16-byte boundaries. The *segment base* is the lowest address in a given segment, and is equal to the segment selector \* 16. The POP and MOV instructions work exactly as in real mode and can be used to load a (possibly) new segment selector into one of the segment registers. When this occurs, the selector is updated and the selector base is set to selector \* 16. The segment limit and segment attributes are unchanged, but are normally 64K (the maximum allowable limit) and read/write data, respectively.

FAR transfers, with the exception of interrupts and exceptions, operate as in real mode. On FAR transfers, the CS (code segment) selector is updated to the new value, and the CS segment base is set to selector \* 16. The CS segment limit and attributes are unchanged, but are usually 64K and read/write, respectively. Interrupts and exceptions switch the processor to protected mode. (See Chapter 8, “Exceptions and Interrupts” for more information.)

## 4.3 Protected Mode Segmented-Memory Models

System software can use the segmentation mechanism to support one of two basic segmented-memory models: a flat-memory model or a multi-segmented model. These segmentation models are supported in legacy mode and in compatibility mode. Each type of model is described in the following sections.

### 4.3.1 Multi-Segmented Model

In the multi-segmented memory model, each segment register can reference a unique base address with a unique segment size. Segments can be as small as a single byte or as large as 4 Gbytes. When page translation is used, multiple segments can be mapped to a single page and multiple pages can be mapped to a single segment. Figure 1-1 on page 6 shows an example of the multi-segmented model.

The multi-segmented memory model provides the greatest level of flexibility for system software using the segmentation mechanism.

Compatibility mode allows the multi-segmented model to be used in support of legacy software. However, in compatibility mode, the multi-segmented memory model is restricted to the first 4 Gbytes of virtual-memory space. Access to virtual memory above 4 Gbytes requires the use of 64-bit mode, which does not support segmentation.

### 4.3.2 Flat-Memory Model

The flat-memory model is the simplest form of segmentation to implement. Although segmentation cannot be disabled, the flat-memory model allows system software to bypass most of the segmentation mechanism. In the flat-memory model, all segment-base addresses have a value of 0 and the segment limits are fixed at 4 Gbytes. Clearing the segment-base value to 0 effectively disables segment translation, resulting in a single segment spanning the entire virtual-address space. All segment descriptors reference this single, flat segment. Figure 1-2 on page 7 shows an example of the flat-memory model.

### 4.3.3 Segmentation in 64-Bit Mode

In 64-bit mode, segmentation is disabled. The segment-base value is ignored and treated as 0 by the segmentation hardware. Likewise, segment limits and most attributes are ignored. There are a few exceptions. The CS-segment DPL, D, and L attributes are used (respectively) to establish the privilege level for a program, the default operand size, and whether the program is running in 64-bit mode or compatibility mode. The FS and GS segments can be used as additional base registers in address calculations, and those segments can have non-zero base-address values. This facilitates addressing thread-local data and certain system-software data structures. See “FS and GS Registers in 64-Bit Mode” on page 72 for details about the FS and GS segments in 64-bit mode. The system-segment registers are always used in 64-bit mode.

## 4.4 Segmentation Data Structures and Registers

Figure 4-1 on page 68 shows the following data structures used by the segmentation mechanism:

- *Segment Descriptors*—As the name implies, a segment descriptor *describes* a segment, including its location in virtual-address space, its size, protection characteristics, and other attributes.
- *Descriptor Tables*—Segment descriptors are stored in memory in one of three tables. The global-descriptor table (GDT) holds segment descriptors that can be shared among all tasks. Multiple local-descriptor tables (LDT) can be defined to hold descriptors that are used by specific tasks and are not shared globally. The interrupt-descriptor table (IDT) holds gate descriptors that are used to access the segments where interrupt handlers are located.
- *Task-State Segment*—A task-state segment (TSS) is a special type of system segment that contains task-state information and data structures for each task. For example, a TSS holds a copy of the GPRs and EFLAGS register when a task is suspended. A TSS also holds the pointers to privileged-

software stacks. The TSS and task-switch mechanism are described in Chapter 12, “Task Management.”

- *Segment Selectors*—Descriptors are selected for use from the descriptor tables using a segment selector. A segment selector contains an index into either the GDT or LDT. The IDT is indexed using an interrupt vector, as described in “Legacy Protected-Mode Interrupt Control Transfers” on page 237, and in “Long-Mode Interrupt Control Transfers” on page 247.

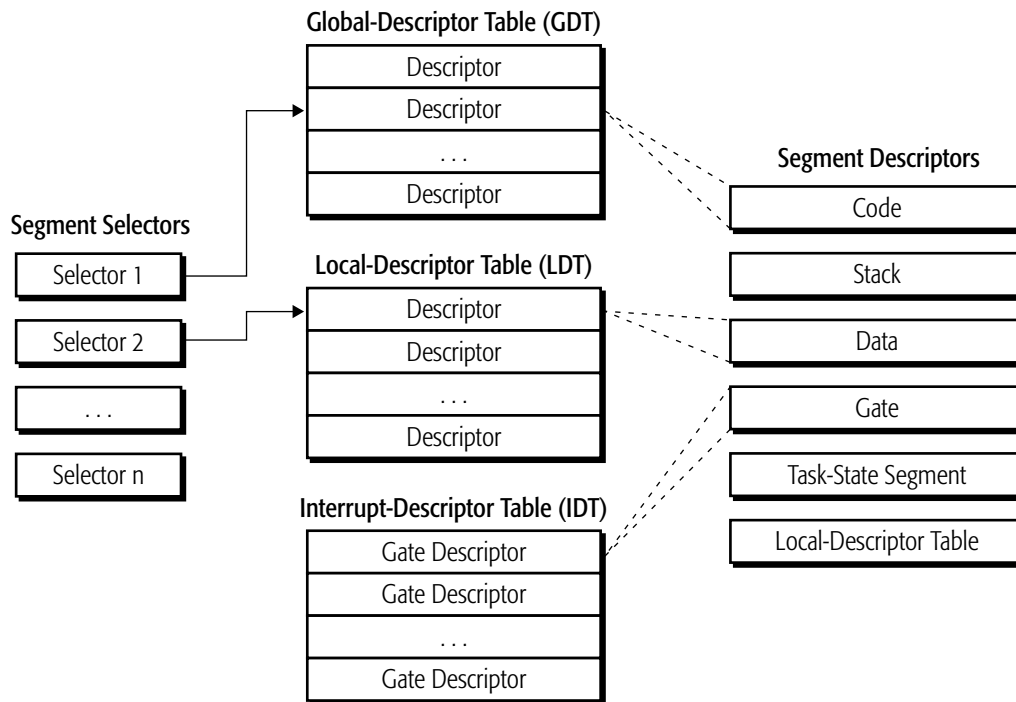

**Figure 4-1. Segmentation Data Structures**

Figure 4-2 on page 69 shows the registers used by the segmentation mechanism. The registers have the following relationship to the data structures:

- *Segment Registers*—The six segment registers (CS, DS, ES, FS, GS, and SS) are used to point to the user segments. A segment selector selects a descriptor when it is loaded into one of the segment registers. This causes the processor to automatically load the selected descriptor into a software-invisible portion of the segment register.
- *Descriptor-Table Registers*—The three descriptor-table registers (GDTR, LDTR, and IDTR) are used to point to the system segments. The descriptor-table registers identify the virtual-memory location and size of the descriptor tables.
- *Task Register (TR)*—Describes the location and limit of the current task state segment (TSS).

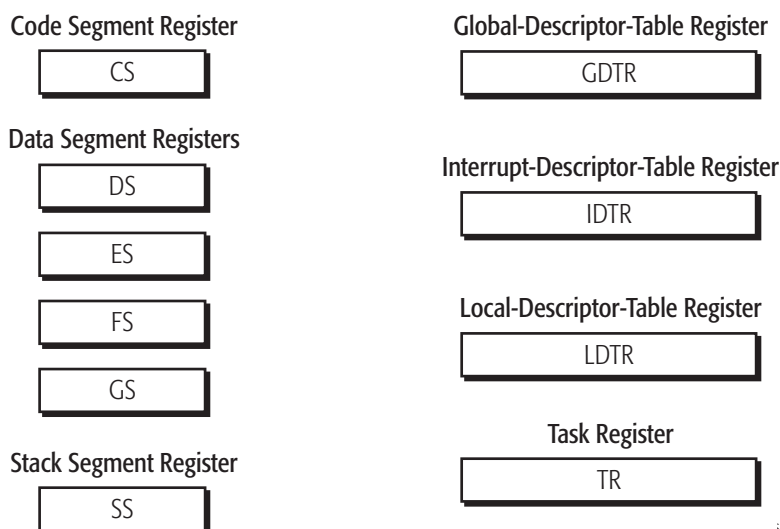

**Figure 4-2. Segment and Descriptor-Table Registers**

A fourth system-segment register, the TR, points to the TSS. The data structures and registers associated with task-state segments are described in “Task-Management Resources” on page 328.

## 4.5 Segment Selectors and Registers

### 4.5.1 Segment Selectors

Segment selectors are pointers to specific entries in the global and local descriptor tables. Figure 4-3 shows the segment selector format.

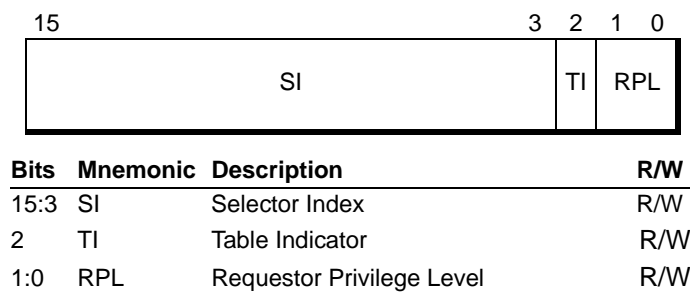

**Figure 4-3. Segment Selector**

The selector format consists of the following fields:

**Selector Index Field.** Bits 15:3. The selector-index field specifies an entry in the descriptor table. Descriptor-table entries are eight bytes long, so the selector index is scaled by 8 to form a byte offset into the descriptor table. The offset is then added to either the global or local descriptor-table base address (as indicated by the table-index bit) to form the descriptor-entry address in virtual-address space.

Some descriptor entries in long mode are 16 bytes long rather than 8 bytes (see “Legacy Segment Descriptors” on page 80 for more information on long-mode descriptor-table entries). These expanded descriptors consume two entries in the descriptor table. Long mode, however, continues to scale the selector index by eight to form the descriptor-table offset. It is the responsibility of system software to assign selectors such that they correctly point to the start of an expanded entry.

**Table Indicator (TI) Bit.** Bit 2. The TI bit indicates which table holds the descriptor referenced by the selector index. When TI=0 the GDT is used and when TI=1 the LDT is used. The descriptor-table base address is read from the appropriate descriptor-table register and added to the scaled selector index as described above.

**Requestor Privilege-Level (RPL) Field.** Bits 1:0. The RPL represents the privilege level (CPL) the processor is operating under at the time the selector is created.

RPL is used in segment privilege-checks to prevent software running at lesser privilege levels from accessing privileged data. See “Data-Access Privilege Checks” on page 97 and “Control-Transfer Privilege Checks” on page 100 for more information on segment privilege-checks.

**Null Selector.** Null selectors have a selector index of 0 and TI=0, corresponding to the first entry in the GDT. However, null selectors do not reference the first GDT entry but are instead used to invalidate unused segment registers. A general-protection exception (#GP) occurs if a reference is made to use a segment register containing a null selector in non-64-bit mode. By initializing unused segment registers with null selectors software can trap references to unused segments.

Null selectors can only be loaded into the DS, ES, FS and GS data-segment registers, and into the LDTR descriptor-table register. A #GP occurs if software attempts to load the CS register with a null selector or if software attempts to load the SS register with a null selector in non 64-bit mode or at CPL 3.

## 4.5.2 Segment Registers

Six 16-bit segment registers are provided for referencing up to six segments at one time. All software tasks require segment selectors to be loaded in the CS and SS registers. Use of the DS, ES, FS, and GS segments is optional, but nearly all software accesses data and therefore requires a selector in the DS register. Table 4-1 on page 71 lists the supported segment registers and their functions.

**Table 4-1. Segment Registers**

Segment Register	Encoding	Segment Register Function
ES	/0	References optional data-segment descriptor entry
CS	/1	References code-segment descriptor entry
SS	/2	References stack segment descriptor entry
DS	/3	References default data-segment descriptor entry
FS	/4	References optional data-segment descriptor entry
GS	/5	References optional data-segment descriptor entry

The processor maintains a *hidden portion* of the segment register in addition to the selector value loaded by software. This hidden portion contains the values found in the descriptor-table entry referenced by the segment selector. The processor loads the descriptor-table entry into the hidden portion when the segment register is loaded. By keeping the corresponding descriptor-table entry in hardware, performance is optimized for the majority of memory references.

Figure 4-4 shows the format of the visible and hidden portions of the segment register. Except for the FS and GS segment base, software cannot directly read or write the hidden portion (shown as gray-shaded boxes in Figure 4-4).

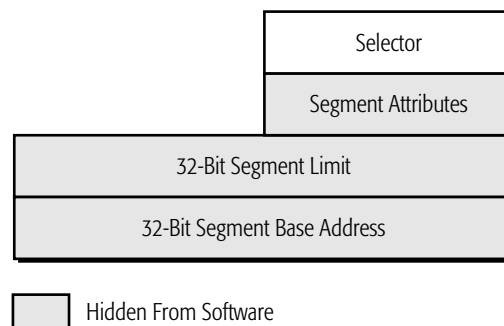
**Figure 4-4. Segment-Register Format**

**CS Register.** The CS register contains the segment selector referencing the current code-segment descriptor entry. All instruction fetches reference the CS descriptor. When a new selector is loaded into the CS register, the current-privilege level (CPL) of the processor is set to that of the CS-segment descriptor-privilege level (DPL).

**Data-Segment Registers.** The DS register contains the segment selector referencing the default data-segment descriptor entry. The SS register contains the stack-segment selector. The ES, FS, and GS registers are optionally loaded with segment selectors referencing other data segments. Data accesses default to referencing the DS descriptor except in the following two cases:





Segment register-load instructions (MOV to Sreg and POP Sreg) load only a 32-bit base-address value into the hidden portion of the FS and GS segment registers. The base-address bits above the low 32 bits are cleared to 0 as a result of a segment-register load.

There are two methods to update the contents of the FS.base and GS.base hidden descriptor fields. The first is available exclusively to privileged software (CPL = 0). The FS.base and GS.base hidden descriptor-register fields are mapped to MSRs. Privileged software can load a 64-bit base address in canonical form into FS.base or GS.base using a single WRMSR instruction. The FS.base MSR address is C000\_0100h while the GS.base MSR address is C000\_0101h.

The second method of updating the FS and GS base fields is available to software running at any privilege level (when supported by the implementation and enabled by setting CR4[FSGSBASE]). The WRFSBASE and WRGSBASE instructions copy the contents of a GPR to the FS.base and GS.base fields respectively. When the operand size is 32 bits, the upper doubleword of the base is cleared. WRFSBASE and WRGSBASE are only supported in 64-bit mode.

The addresses written into the expanded FS.base and GS.base registers must be in canonical form. Any instruction that attempts to write a non-canonical address to these registers causes a general-protection exception (#GP) to occur.

When in compatibility mode, the FS and GS overrides operate as defined by the legacy x86 architecture regardless of the value loaded into the high 32 bits of the hidden descriptor-register base-address field. Compatibility mode ignores the high 32 bits when calculating an effective address.

## 4.6 Descriptor Tables

Descriptor tables are used by the segmentation mechanism when protected mode is enabled (CR0.PE=1). These tables hold descriptor entries that describe the location, size, and privilege attributes of a segment. All memory references in protected mode access a descriptor-table entry.

As previously mentioned, there are three types of descriptor tables supported by the x86 segmentation mechanism:

- Global descriptor table (GDT)
- Local descriptor table (LDT)
- Interrupt descriptor table (IDT)

Software establishes the location of a descriptor table in memory by initializing its corresponding descriptor-table register. The descriptor-table registers and the descriptor tables are described in the following sections.

### 4.6.1 Global Descriptor Table

Protected-mode system software must create a global descriptor table (GDT). The GDT contains code-segment and data-segment descriptor entries (user segments) for segments that can be shared by all tasks. In addition to the user segments, the GDT can also hold gate descriptors and other system-

segment descriptors. System software can store the GDT anywhere in memory and should protect the segment containing the GDT from non-privileged software.

Segment selectors point to the GDT when the table-index (TI) bit in the selector is cleared to 0. The selector index portion of the segment selector references a specific entry in the GDT. Figure 4-6 on page 74 shows how the segment selector indexes into the GDT. One special form of a segment selector is the *null selector*. A null selector points to the first entry in the GDT (the selector index is 0 and TI=0). However, null selectors do not reference memory, so the first GDT entry cannot be used to describe a segment (see “Null Selector” on page 70 for information on using the null selector). The first usable GDT entry is referenced with a selector index of 1.

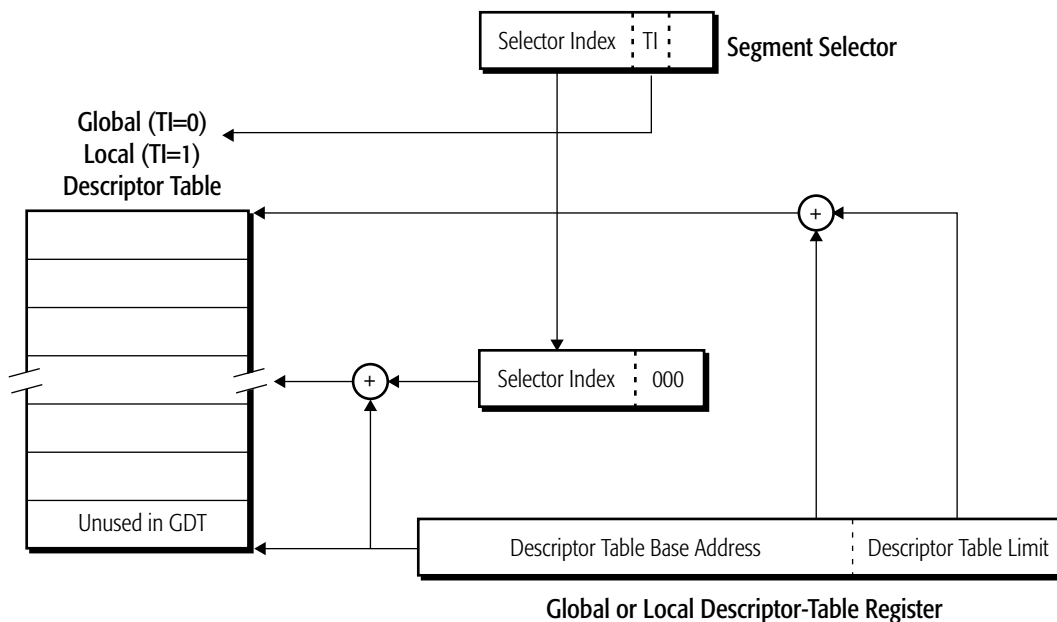

**Figure 4-6. Global and Local Descriptor-Table Access**

#### 4.6.2 Global Descriptor-Table Register

The global descriptor-table register (GDTR) points to the location of the GDT in memory and defines its size. This register is loaded from memory using the LGDT instruction (see “LGDT and LIDT Instructions” on page 158). Figure 4-7 shows the format of the GDTR in legacy mode and compatibility mode.

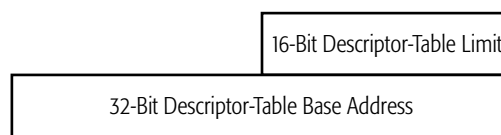

**Figure 4-7. GDTR and IDTR Format—Legacy Modes**

Figure 4-8 on page 75 shows the format of the GDTR in 64-bit mode.



**Figure 4-8. GDTR and IDTR Format—Long Mode**

The GDTR contains two fields:

**Limit.** 2 bytes. These bits define the 16-bit limit, or size, of the GDT in bytes. The limit value is added to the base address to yield the ending byte address of the GDT. A general-protection exception (#GP) occurs if software attempts to access a descriptor beyond the GDT limit.

The offsets into the descriptor tables are not extended by the AMD64 architecture in support of long mode. Therefore, the GDTR and IDTR limit-field sizes are unchanged from the legacy sizes. The processor does check the limits in long mode during GDT and IDT accesses.

**Base Address.** 8 bytes. The base-address field holds the starting byte address of the GDT in virtual-memory space. The GDT can be located at any byte address in virtual memory, but system software should align the GDT on a doubleword boundary to avoid the potential performance penalties associated with accessing unaligned data.

The AMD64 architecture increases the base-address field of the GDTR to 64 bits so that system software running in long mode can locate the GDT anywhere in the 64-bit virtual-address space. The processor ignores the high-order 4 bytes of base address when running in legacy mode.

### 4.6.3 Local Descriptor Table

Protected-mode system software can optionally create a local descriptor table (LDT) to hold segment descriptors belonging to a single task or even multiple tasks. The LDT typically contains code-

segment and data-segment descriptors as well as gate descriptors referenced by the specified task. Like the GDT, system software can store the LDT anywhere in memory and should protect the segment containing the LDT from non-privileged software.

Segment selectors point to the LDT when the table-index bit (TI) in the selector is set to 1. The selector index portion of the segment selector references a specific entry in the LDT (see Figure 4-6 on page 74). Unlike the GDT, however, a selector index of 0 references the first entry in the LDT (when TI=1, the selector is not a null selector).

LDTs are described by system-segment descriptor entries located in the GDT, and a GDT can contain multiple LDT descriptors. The LDT system-segment descriptor defines the location, size, and privilege rights for the LDT. Figure 4-9 on page 76 shows the relationship between the LDT and GDT data structures.

Loading a null selector into the LDTR is useful if software does not use an LDT. This causes a #GP if an erroneous reference is made to the LDT.

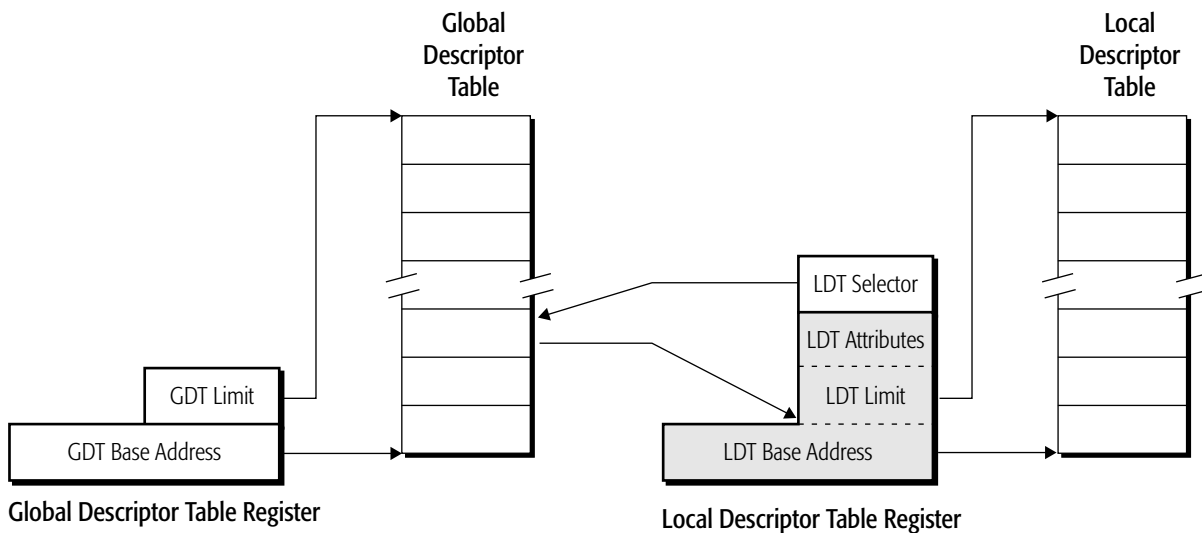

Figure 4-9. Relationship between the LDT and GDT

#### 4.6.4 Local Descriptor-Table Register

The local descriptor-table register (LDTR) points to the location of the LDT in memory, defines its size, and specifies its attributes. The LDTR has two portions. A *visible* portion holds the LDT selector, and a *hidden* portion holds the LDT descriptor. When the LDT selector is loaded into the LDTR, the processor automatically loads the LDT descriptor from the GDT into the hidden portion of the LDTR. The LDTR is loaded in one of two ways:

- Using the LLDT instruction (see “LLDT and LTR Instructions” on page 158).

- Performing a task switch (see “Switching Tasks” on page 341).

Figure 4-10 on page 77 shows the format of the LDTR in legacy mode.

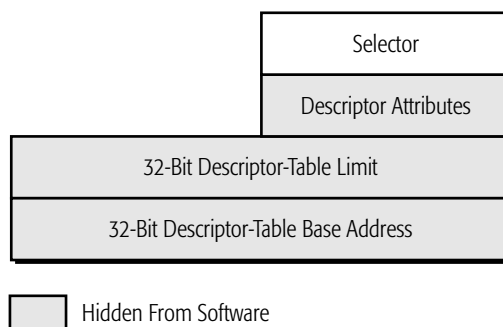

**Figure 4-10. LDTR Format—Legacy Mode**

Figure 4-11 shows the format of the LDTR in long mode (both compatibility mode and 64-bit mode).

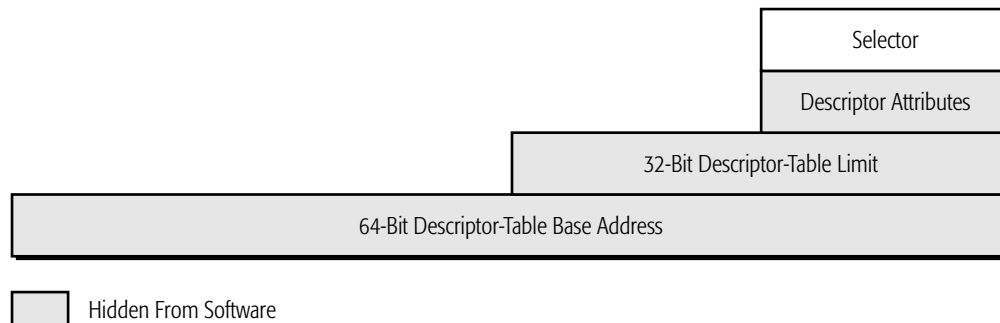

**Figure 4-11. LDTR Format—Long Mode**

The LDTR contains four fields:

**LDT Selector.** 2 bytes. These bits are loaded explicitly from the TSS during a task switch, or by using the LLDT instruction. The LDT selector must point to an LDT system-segment descriptor entry in the GDT. If it does not, a general-protection exception (#GP) occurs.

The following three fields are loaded automatically from the LDT descriptor in the GDT as a result of loading the LDT selector. The register fields are shown as shaded boxes in Figure 4-10 and Figure 4-11.

**Base Address.** The base-address field holds the starting byte address of the LDT in virtual-memory space. Like the GDT, the LDT can be located anywhere in system memory, but software should align the LDT on a doubleword boundary to avoid performance penalties associated with accessing unaligned data.

The AMD64 architecture expands the base-address field of the LDTR to 64 bits so that system software running in long mode can locate an LDT anywhere in the 64-bit virtual-address space. The processor ignores the high-order 32 base-address bits when running in legacy mode. Because the LDTR is loaded from the GDT, the system-segment descriptor format (LDTs are system segments) has been expanded by the AMD64 architecture in support of 64-bit mode. See “Long Mode Descriptor Summary” on page 94 for more information on this expanded format. The high-order base-address bits are only loaded from 64-bit mode using the LLDT instruction (see “LLDT and LTR Instructions” on page 158 for more information on this instruction).

**Limit.** This field defines the limit, or size, of the LDT in bytes. The LDT limit as stored in the LDTR is 32 bits. When the LDT limit is loaded from the GDT descriptor entry, the 20-bit limit field in the descriptor is expanded to 32 bits and scaled based on the value of the descriptor granularity (G) bit. For details on the limit biasing and granularity, see “Granularity (G) Bit” on page 81.

If an attempt is made to access a descriptor beyond the LDT limit, a general-protection exception (#GP) occurs.

The offsets into the descriptor tables are not extended by the AMD64 architecture in support of long mode. Therefore, the LDTR limit-field size is unchanged from the legacy size. The processor does check the LDT limit in long mode during LDT accesses.

**Attributes.** This field holds the descriptor attributes, such as privilege rights, segment presence and segment granularity.

#### 4.6.5 Interrupt Descriptor Table

The final type of descriptor table is the interrupt descriptor table (IDT). Multiple IDTs can be maintained by system software. System software selects a specific IDT by loading the interrupt descriptor table register (IDTR) with a pointer to the IDT. As with the GDT and LDT, system software can store the IDT anywhere in memory and should protect the segment containing the IDT from non-privileged software.

The IDT can contain only the following types of gate descriptors:

- Interrupt gates
- Trap gates
- Task gates.

The use of gate descriptors by the interrupt mechanism is described in Chapter 8, “Exceptions and Interrupts.” A general-protection exception (#GP) occurs if the IDT descriptor referenced by an interrupt or exception is not one of the types listed above.

IDT entries are selected using the interrupt vector number rather than a selector value. The interrupt vector number is scaled by the interrupt-descriptor entry size to form an offset into the IDT. The interrupt-descriptor entry size depends on the processor operating mode as follows:

- In long mode, interrupt descriptor-table entries are 16 bytes.
- In legacy mode, interrupt descriptor-table entries are eight bytes.

Figure 4-12 shows how the interrupt vector number indexes the IDT.

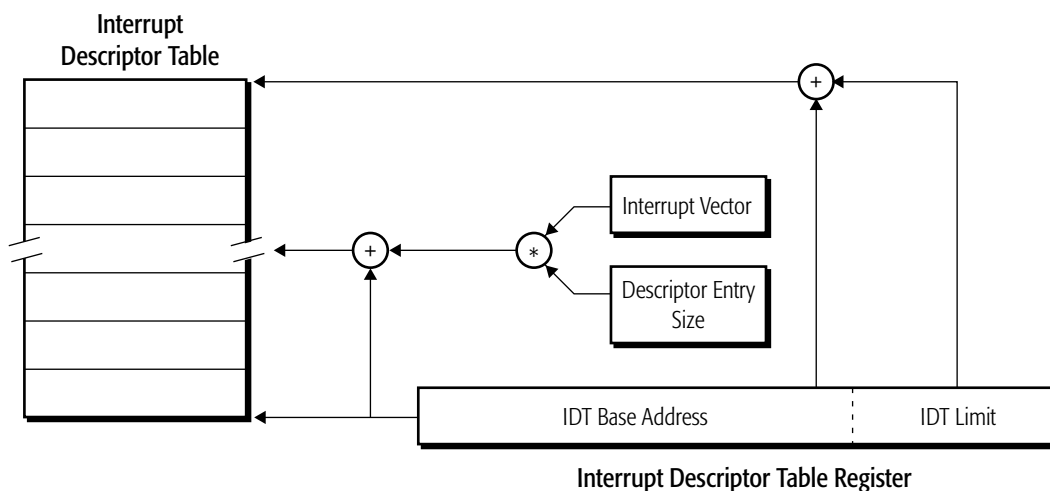

**Figure 4-12. Indexing an IDT**

#### 4.6.6 Interrupt Descriptor-Table Register

The interrupt descriptor-table register (IDTR) points to the IDT in memory and defines its size. This register is loaded from memory using the LIDT instruction (see “LGDT and LIDT Instructions” on page 158). The format of the IDTR is identical to that of the GDTR in all modes. Figure 4-7 on page 75 shows the format of the IDTR in legacy mode. Figure 4-8 on page 75 shows the format of the IDTR in long mode.

The offsets into the descriptor tables are not extended by the AMD64 architecture in support of long mode. Therefore, the IDTR limit-field size is unchanged from the legacy size. The processor does check the IDT limit in long mode during IDT accesses.

## 4.7 Legacy Segment Descriptors

### 4.7.1 Descriptor Format

Segment descriptors define, protect, and isolate segments from each other. There are two basic types of descriptors, each of which are used to describe different segment (or gate) types:

- *User Segments*—These include code segments and data segments. Stack segments are a type of data segment.
- *System Segments*—System segments consist of LDT segments and task-state segments (TSS). Gate descriptors are another type of system-segment descriptor. Rather than describing segments, gate descriptors point to program entry points.

Figure 4-13 shows the generic format for user-segment and system-segment descriptors. User and system segments are differentiated using the S bit. S=1 indicates a user segment, and S=0 indicates a system segment. Gray shading indicates the field or bit is reserved. The format for a gate descriptor differs from the generic segment descriptor, and is described separately in “Gate Descriptors” on page 86.

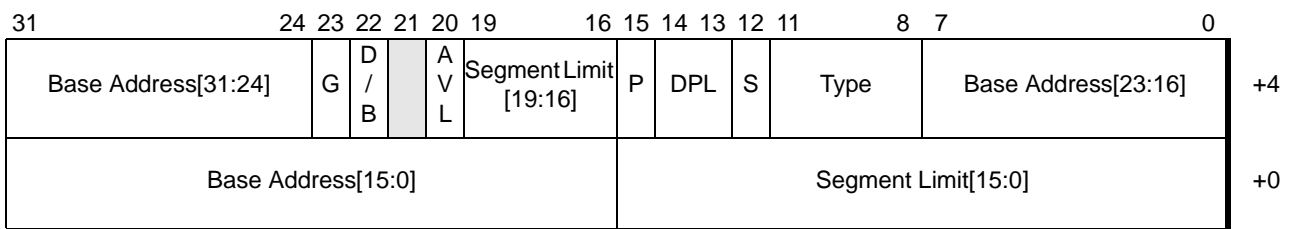

**Figure 4-13. Generic Segment Descriptor—Legacy Mode**

Figure 4-13 shows the fields in a generic, legacy-mode, 8-byte (two doubleword) segment descriptor. In this figure, the upper doubleword (located at byte offset +4) is shown on top and the lower doubleword (located at byte offset +0) is shown on the bottom. The fields are defined as follows:

**Segment Limit.** The 20-bit segment limit is formed by concatenating bits 19:16 of the upper doubleword with bits 15:0 of lower doubleword. The segment limit defines the segment size, in bytes. The granularity (G) bit controls how the segment-limit field is scaled (see “Granularity (G) Bit” on page 81). For data segments, the expand-down (E) bit determines whether the segment limit defines the lower or upper segment-boundary (see “Expand-Down (E) Bit” on page 84).

If software references a segment descriptor with an address beyond the segment limit, a general-protection exception (#GP) occurs. The #GP occurs if any part of the memory reference falls outside the segment limit. For example, a doubleword (4-byte) address reference causes a #GP if one or more bytes are located beyond the segment limit.

**Base Address.** The 32-bit base address is formed by concatenating bits 31:24 of the upper doubleword with bits 7:0 of the same doubleword and bits 15:0 of the lower doubleword. The segment-base address field locates the start of a segment in virtual-address space.



**S Bit and Type Field.** Bit 12 and bits 11:8 of the upper doubleword. The S and Type fields, together, specify the descriptor type and its access characteristics. Table 4-2 summarizes the descriptor types by S-field encoding and gives a cross reference to descriptions of the Type-field encodings.

**Table 4-2. Descriptor Types**

S Field	Descriptor Type	Type-Field Encoding
0 (System)	LDT	See Table 4-5 on page 85
	TSS	
	Gate	
1 (User)	Code	See Table 4-3 on page 83
	Data	See Table 4-4 on page 84

**Descriptor Privilege-Level (DPL) Field.** Bits 14:13 of the upper doubleword. The DPL field indicates the descriptor-privilege level of the segment. DPL can be set to any value from 0 to 3, with 0 specifying the most privilege and 3 the least privilege. See “Data-Access Privilege Checks” on page 97 and “Control-Transfer Privilege Checks” on page 100 for more information on how the DPL is used during segment privilege-checks.

**Present (P) Bit.** Bit 15 of the upper doubleword. The segment-present bit indicates that the segment referenced by the descriptor is loaded in memory. If a reference is made to a descriptor entry when  $P = 0$ , a segment-not-present exception (#NP) occurs. This bit is set and cleared by system software and is never altered by the processor.

**Available To Software (AVL) Bit.** Bit 20 of the upper doubleword. This field is available to software, which can write any value to it. The processor does not set or clear this field.

**Default Operand Size (D/B) Bit.** Bit 22 of the upper doubleword. The default operand-size bit is found in code-segment and data-segment descriptors but not in system-segment descriptors. Setting this bit to 1 indicates a 32-bit default operand size, and clearing it to 0 indicates a 16-bit default size. The effect this bit has on a segment depends on the segment-descriptor type. See “Code-Segment Default-Operand Size (D) Bit” on page 83 for a description of the D bit in code-segment descriptors. “Data-Segment Default Operand Size (D/B) Bit” on page 85 describes the D bit in data-segment descriptors, including stack segments, where the bit is referred to as the “B” bit.

**Granularity (G) Bit.** Bit 23 of the upper doubleword. The granularity bit specifies how the segment-limit field is scaled. Clearing the G bit to 0 indicates that the limit field is not scaled. In this case, the limit equals the number of bytes available in the segment. Setting the G bit to 1 indicates that the limit field is scaled by 4 Kbytes (4096 bytes). Here, the limit field equals the number of 4-Kbyte *blocks* available in the segment.

Setting a limit of 0 indicates a 1-byte segment limit when  $G = 0$ . Setting the same limit of 0 when  $G = 1$  indicates a segment limit of 4095.

**Reserved Bits.** Generally, software should clear all reserved bits to 0, so they can be defined in future revisions to the AMD64 architecture.

### 4.7.2 Code-Segment Descriptors

Figure 4-14 shows the code-segment descriptor format (gray shading indicates the bit is reserved). All software tasks require that a segment selector, referencing a valid code-segment descriptor, is loaded into the CS register. Code segments establish the processor operating mode and execution privilege-level. The segments generally contain only instructions and are execute-only, or execute and read-only. Software cannot write into a segment whose selector references a code-segment descriptor.

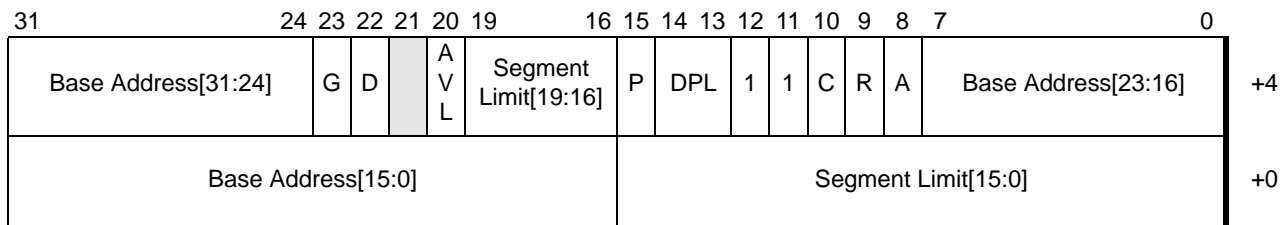

**Figure 4-14. Code-Segment Descriptor—Legacy Mode**

Code-segment descriptors have the *S* bit set to 1, identifying the segments as user segments. Type-field bit 11 differentiates code-segment descriptors (bit 11 set to 1) from data-segment descriptors (bit 11 cleared to 0). The remaining type-field bits (10:8) define the access characteristics for the code-segment, as follows:

**Conforming (C) Bit.** Bit 10 of the upper doubleword. Setting this bit to 1 identifies the code segment as *conforming*. When control is transferred to a higher-privilege conforming code-segment (*C*=1) from a lower-privilege code segment, the processor CPL does not change. Transfers to non-conforming code-segments (*C* = 0) with a higher privilege-level than the CPL can occur only through gate descriptors. See “Control-Transfer Privilege Checks” on page 100 for more information on conforming and non-conforming code-segments.

**Readable (R) Bit.** Bit 9 of the upper doubleword. Setting this bit to 1 indicates the code segment is both executable and readable as data. When this bit is cleared to 0, the code segment is executable, but attempts to read data from the code segment cause a general-protection exception (#GP) to occur.

**Accessed (A) Bit.** Bit 8 of the upper doubleword. The accessed bit is set to 1 by the processor when the descriptor is copied from the GDT or LDT into the CS register. This bit is only cleared by software.

Table 4-3 on page 83 summarizes the code-segment type-field encodings.

Table 4-3. Code-Segment Descriptor Types

Hex Value	Type Field				Description
	Bit 11 (Code/Data)	Bit 10 Conforming (C)	Bit 9 Readable (R)	Bit 8 Accessed (A)	
8	1	0	0	0	Execute-Only
9		0	0	1	Execute-Only — Accessed
A		0	1	0	Execute/Readable
B		0	1	1	Execute/Readable — Accessed
C		1	0	0	Conforming, Execute-Only
D		1	0	1	Conforming, Execute-Only — Accessed
E		1	1	0	Conforming, Execute/Readable
F		1	1	1	Conforming, Execute/Readable — Accessed

**Code-Segment Default-Operand Size (D) Bit.** Bit 22 of byte +4. In code-segment descriptors, the D bit selects the default operand size and address sizes. In legacy mode, when D=0 the default operand size and address size is 16 bits and when D=1 the default operand size and address size is 32 bits. Instruction prefixes can be used to override the operand size or address size, or both.

### 4.7.3 Data-Segment Descriptors

Figure 4-15 shows the data-segment descriptor format. Data segments contain non-executable information and can be accessed as read-only or read/write. They are referenced using the DS, ES, FS, GS, or SS data-segment registers. The DS data-segment register holds the segment selector for the default data segment. The ES, FS and GS data-segment registers hold segment selectors for additional data segments usable by the current software task.

The stack segment is a special form of data-segment register. It is referenced using the SS segment register and must be read/write. When loading the SS register, the processor requires that the selector reference a valid, writable data-segment descriptor.

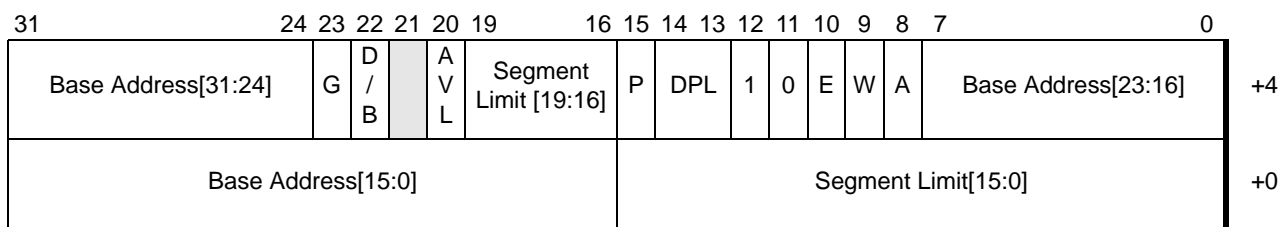

Figure 4-15. Data-Segment Descriptor—Legacy Mode

Data-segment descriptors have the S bit set to 1, identifying them as user segments. Type-field bit 11 differentiates data-segment descriptors (bit 11 cleared to 0) from code-segment descriptors (bit 11 set to 1). The remaining type-field bits (10:8) define the data-segment access characteristics, as follows:

**Expand-Down (E) Bit.** Bit 10 of the upper doubleword. Setting this bit to 1 identifies the data segment as *expand-down*. In expand-down segments, the segment limit defines the *lower* segment boundary while the base is the upper boundary. Valid segment offsets in expand-down segments lie in the byte range limit+1 to FFFFh or FFFF\_FFFFh, depending on the value of the data segment default operand size (D/B) bit.

Expand-down segments are useful for stacks, which grow in the downward direction as elements are pushed onto the stack. The stack pointer, ESP, is *decremented* by an amount equal to the operand size as a result of executing a PUSH instruction.

Clearing the E bit to 0 identifies the data segment as expand-up. Valid segment offsets in expand-up segments lie in the byte range 0 to segment limit.

**Writable (W) Bit.** Bit 9 of the upper doubleword. Setting this bit to 1 identifies the data segment as read/write. When this bit is cleared to 0, the segment is read-only. A general-protection exception (#GP) occurs if software attempts to write into a data segment when W=0.

**Accessed (A) Bit.** Bit 8 of the upper doubleword. The accessed bit is set to 1 by the processor when the descriptor is copied from the GDT or LDT into one of the data-segment registers or the stack-segment register. This bit is only cleared by software.

Table 4-4 summarizes the data-segment type-field encodings.

**Table 4-4. Data-Segment Descriptor Types**

Hex Value	Type Field			Description	
	Bit 11 (Code/Data)	Bit 10 Expand-Down (E)	Bit 9 Writable (W)		Bit 8 Accessed (A)
0	0	0	0	0	Read-Only
1		0	0	1	Read-Only — Accessed
2		0	1	0	Read/Write
3		0	1	1	Read/Write — Accessed
4		1	0	0	Expand-down, Read-Only
5		1	0	1	Expand-down, Read-Only — Accessed
6		1	1	0	Expand-down, Read/Write
7		1	1	1	Expand-down, Read/Write — Accessed

**Data-Segment Default Operand Size (D/B) Bit.** Bit 22 of the upper doubleword. For expand-down data segments (E=1), setting D=1 sets the upper bound of the segment at 0\_FFFF\_FFFFh. Clearing D=0 sets the upper bound of the segment at 0\_FFFFh.

In the case where a data segment is referenced by the stack selector (SS), the D bit is referred to as the B bit. For stack segments, the B bit sets the default stack size. Setting B=1 establishes a 32-bit stack referenced by the 32-bit ESP register. Clearing B=0 establishes a 16-bit stack referenced by the 16-bit SP register.

#### 4.7.4 System Descriptors

There are two general types of system descriptors: system-segment descriptors and gate descriptors. System-segment descriptors are used to describe the LDT and TSS segments. Gate descriptors do not describe segments, but instead hold pointers to code-segment descriptors. Gate descriptors are used for protected-mode control transfers between less-privileged and more-privileged software.

System-segment descriptors have the S bit cleared to 0. The type field is used to differentiate the various LDT, TSS, and gate descriptors from one another. Table 4-5 summarizes the system-segment type-field encodings.

**Table 4-5. System-Segment Descriptor Types (S=0)—Legacy Mode**

Hex Value	Type Field (Bits 11:8)	Description
0	0000	Reserved (Illegal)
1	0001	Available 16-bit TSS
2	0010	LDT
3	0011	Busy 16-bit TSS
4	0100	16-bit Call Gate
5	0101	Task Gate
6	0110	16-bit Interrupt Gate
7	0111	16-bit Trap Gate
8	1000	Reserved (Illegal)
9	1001	Available 32-bit TSS
A	1010	Reserved (Illegal)
B	1011	Busy 32-bit TSS
C	1100	32-bit Call Gate
D	1101	Reserved (Illegal)
E	1110	32-bit Interrupt Gate
F	1111	32-bit Trap Gate

Figure 4-16 shows the legacy-mode system-segment descriptor format used for referencing LDT and TSS segments (gray shading indicates the bit is reserved). This format is also used in compatibility mode. The system-segments are used as follows:

- The LDT typically holds segment descriptors belonging to a single task (see “Local Descriptor Table” on page 75).
- The TSS is a data structure for holding processor-state information. Processor state is saved in a TSS when a task is suspended, and state is restored from the TSS when a task is restarted. System software must create at least one TSS referenced by the task register, TR. See “Legacy Task-State Segment” on page 333 for more information on the TSS.

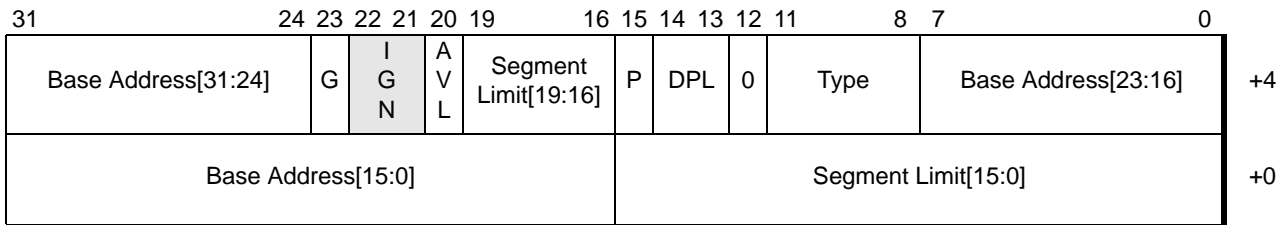
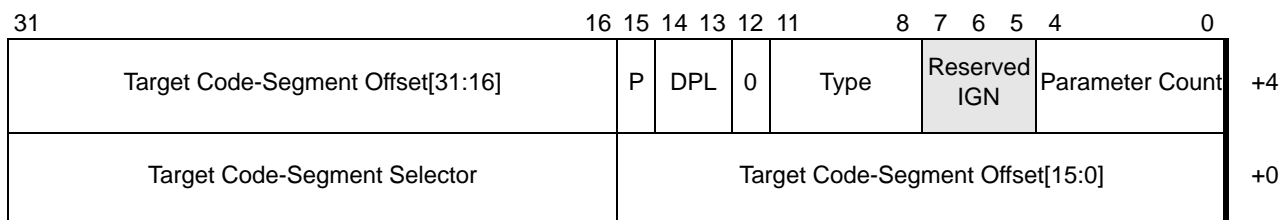

Figure 4-16. LDT and TSS Descriptor—Legacy/Compatibility Modes

### 4.7.5 Gate Descriptors

Gate descriptors hold pointers to code segments and are used to control access between code segments with different privilege levels. There are four types of gate descriptors:

- *Call Gates*—These gates (Figure 4-17 on page 87) are located in the GDT or LDT and are used to control access between code segments in the same task or in different tasks. See “Control Transfers Through Call Gates” on page 104 for information on how call gates are used to control access between code segments operating in the same task. The format of a call-gate descriptor is shown in Figure 4-17 on page 87.
- *Interrupt Gates* and *Trap Gates*—These gates (Figure 4-18 on page 87) are located in the IDT and are used to control access to interrupt-service routines. “Legacy Protected-Mode Interrupt Control Transfers” on page 237 contains information on using these gates for interrupt-control transfers. The format of interrupt-gate and trap-gate descriptors is shown in Figure 4-17 on page 87.
- *Task Gates*—These gates (Figure 4-19 on page 87) are used to control access between different tasks. They are also used to transfer control to interrupt-service routines if those routines are themselves a separate task. See “Task-Management Resources” on page 328 for more information on task gates and their use.



**Figure 4-17. Call-Gate Descriptor—Legacy Mode**

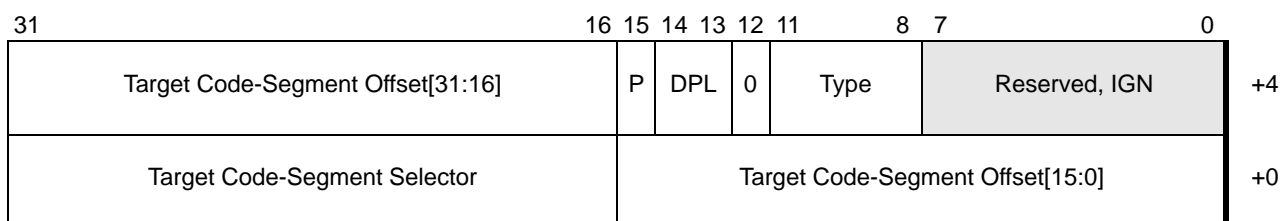

**Figure 4-18. Interrupt-Gate and Trap-Gate Descriptors—Legacy Mode**

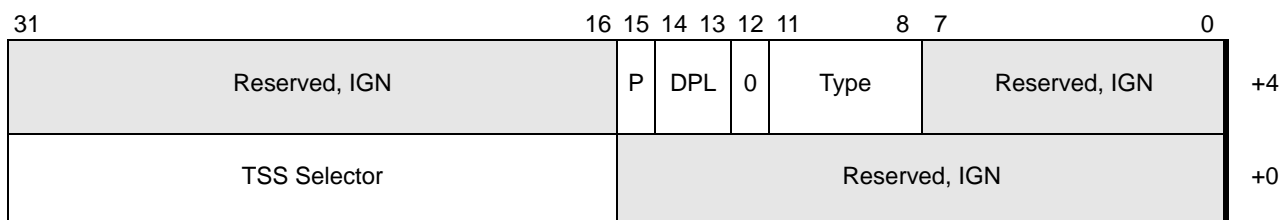

**Figure 4-19. Task-Gate Descriptor—Legacy Mode**

There are several differences between the gate-descriptor format and the system-segment descriptor format. These differences are described as follows, from least-significant to most-significant bit positions:

**Target Code-Segment Offset.** The 32-bit segment offset is formed by concatenating bits 31:16 of byte +4 with bits 15:0 of byte +0. The segment-offset field specifies the target-procedure entry point (offset) into the segment. This field is loaded into the EIP register as a result of a control transfer using the gate descriptor.

**Target Code-Segment Selector.** Bits 31:16 of byte +0. The segment-selector field identifies the target-procedure segment descriptor, located in either the GDT or LDT. The segment selector is loaded into the CS segment register as a result of a control transfer using the gate descriptor.

**TSS Selector.** Bits 31:16 of byte +0 (task gates only). This field identifies the target-task TSS descriptor, located in any of the three descriptor tables (GDT, LDT, and IDT).

**Parameter Count (Call Gates Only).** Bits 4:0 of byte +4. Legacy-mode call-gate descriptors contain a 5-bit *parameter-count* field. This field specifies the number of parameters to be copied from the currently-executing program stack to the target program stack during an automatic stack switch. Automatic stack switches are performed by the processor during a control transfer through a call gate to a greater privilege-level. The parameter size depends on the call-gate size as specified in the type field. 32-bit call gates copy 4-byte parameters, and 16-bit call gates copy 2-byte parameters. See “Stack Switching” on page 108 for more information on call-gate parameter copying.

## 4.8 Long-Mode Segment Descriptors

The interpretation of descriptor fields is changed in long mode, and in some cases the format is expanded. The changes depend on the operating mode (compatibility mode or 64-bit mode) and on the descriptor type. The following sections describe the changes.

### 4.8.1 Code-Segment Descriptors

Code segments continue to exist in long mode. Code segments and their associated descriptors and selectors are needed to establish the processor operating mode as well as execution privilege-level. The new L attribute specifies whether the processor is running in compatibility mode or 64-bit mode (see “Long (L) Attribute Bit” on page 89). Figure 4-20 shows the long-mode code-segment descriptor format. In compatibility mode, the code-segment descriptor is interpreted and behaves just as it does in legacy mode as described in “Code-Segment Descriptors” on page 82.

In Figure 4-20, gray shading indicates the code-segment descriptor fields that are *ignored in 64-bit mode* when the descriptor is used during a memory reference. However, the fields are loaded whenever the segment register is loaded in 64-bit mode.

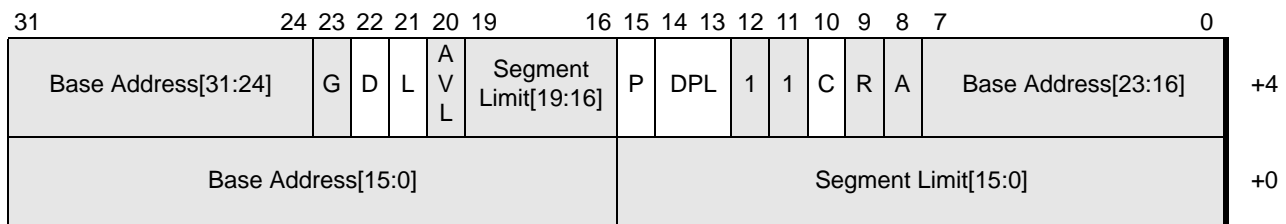

**Figure 4-20. Code-Segment Descriptor—Long Mode**

**Fields Ignored in 64-Bit Mode.** Segmentation is disabled in 64-bit mode, and code segments span all of virtual memory. In this mode, code-segment base addresses are ignored. For the purpose of virtual-address calculations, the base address is treated as if it has a value of zero.

Segment-limit checking is not performed, and both the segment-limit field and granularity (G) bit are ignored. Instead, the virtual address is checked to see if it is in canonical-address form.

The readable (R) and accessed (A) attributes in the type field are also ignored.



**Long (L) Attribute Bit.** Bit 21 of byte +4. Long mode introduces a new attribute, the *long* (L) bit, in code-segment descriptors. This bit specifies that the processor is running in 64-bit mode (L=1) or compatibility mode (L=0). When the processor is running in legacy mode, this bit is reserved.

Compatibility mode maintains binary compatibility with legacy 16-bit and 32-bit applications. Compatibility mode is selected on a code-segment basis, and it allows legacy applications to coexist under the same 64-bit system software along with 64-bit applications running in 64-bit mode. System software running in long mode can execute existing 16-bit and 32-bit applications by clearing the L bit of the code-segment descriptor to 0.

When L=0, the legacy meaning of the code-segment D bit (see “Code-Segment Default-Operand Size (D) Bit” on page 83)—and the address-size and operand-size prefixes—are observed. Segmentation is enabled when L=0. From an application viewpoint, the processor is in a legacy 16-bit or 32-bit operating environment (depending on the D bit), even though long mode is activated.

If the processor is running in 64-bit mode (L=1), the only valid setting of the D bit is 0. This setting produces a default operand size of 32 bits and a default address size of 64 bits. The combination L=1 and D=1 is reserved for future use.

“Instruction Prefixes” in Volume 3 describes the effect of the code-segment L and D bits on default operand and address sizes when long mode is activated. These default sizes can be overridden with operand size, address size, and REX prefixes.

## 4.8.2 Data-Segment Descriptors

Data segments continue to exist in long mode. Figure 4-21 shows the long-mode data-segment descriptor format. In compatibility mode, data-segment descriptors are interpreted and behave just as they do in legacy mode.

In Figure 4-21, gray shading indicates the fields that are *ignored in 64-bit mode* when the descriptor is used during a memory reference. However, the fields are loaded whenever the segment register is loaded in 64-bit mode.

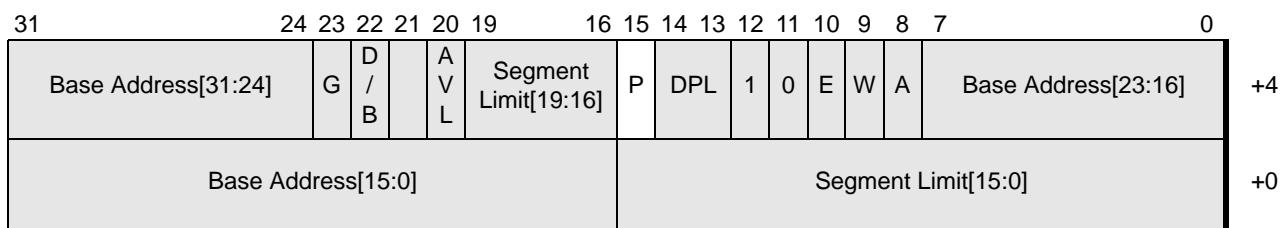

**Figure 4-21. Data-Segment Descriptor—Long Mode**

**Fields Ignored in 64-Bit Mode.** Segmentation is disabled in 64-bit mode. The interpretation of the segment-base address depends on the segment register used:

- In data-segment descriptors referenced by the DS, ES and SS segment registers, the base-address field is ignored. For the purpose of virtual-address calculations, the base address is treated as if it has a value of zero.
- Data segments referenced by the FS and GS segment registers receive special treatment in 64-bit mode. For these segments, the base address field is not ignored, and a non-zero value can be used in virtual-address calculations. A 64-bit segment-base address can be specified using model-specific registers. See “FS and GS Registers in 64-Bit Mode” on page 72 for more information.

Segment-limit checking is not performed on any data segments in 64-bit mode, and both the segment-limit field and granularity (G) bit are ignored. The D/B bit is unused in 64-bit mode.

The expand-down (E), writable (W), and accessed (A) type-field attributes are ignored.

A data-segment-descriptor DPL field is ignored in 64-bit mode, and segment-privilege checks are not performed on data segments. System software can use the page-protection mechanisms to isolate and protect data from unauthorized access.

### 4.8.3 System Descriptors

In long mode, the allowable system-descriptor types encoded by the type field are changed. Some descriptor types are modified, and others are illegal. The changes are summarized in Table 4-6. An attempt to use an illegal descriptor type causes a general-protection exception (#GP).

**Table 4-6. System-Segment Descriptor Types—Long Mode**

Hex Value	Type Field				Description
	Bit 11	Bit 10	Bit 9	Bit 8	
0	0	0	0	0	Reserved (Illegal)
1	0	0	0	1	
2	0	0	1	0	64-bit LDT <sup>1</sup>
3	0	0	1	1	Reserved (Illegal)
4	0	1	0	0	
5	0	1	0	1	
6	0	1	1	0	
7	0	1	1	1	
8	1	0	0	0	Available 64-bit TSS
9	1	0	0	1	
A	1	0	1	0	Reserved (Illegal)
B	1	0	1	1	Busy 64-bit TSS
C	1	1	0	0	64-bit Call Gate

**Note(s):**  
1. In 64-bit mode only. In compatibility mode, the type specifies a 32-bit LDT.

**Table 4-6. System-Segment Descriptor Types—Long Mode (continued)**

Hex Value	Type Field				Description
	Bit 11	Bit 10	Bit 9	Bit 8	
D	1	1	0	1	Reserved (Illegal)
E	1	1	1	0	64-bit Interrupt Gate
F	1	1	1	1	64-bit Trap Gate

**Note(s):**  
1. In 64-bit mode only. In compatibility mode, the type specifies a 32-bit LDT.

In long mode, the modified system-segment descriptor types are:

- The 32-bit LDT (02h), which is redefined as the 64-bit LDT.
- The available 32-bit TSS (09h), which is redefined as the available 64-bit TSS.
- The busy 32-bit TSS (0Bh), which is redefined as the busy 64-bit TSS.

In 64-bit mode, the LDT and TSS system-segment descriptors are expanded by 64 bits, as shown in Figure 4-22. In this figure, gray shading indicates the fields that are *ignored in 64-bit mode*. Expanding the descriptors allows them to hold 64-bit base addresses, so their segments can be located anywhere in the virtual-address space. The expanded descriptor can be loaded into the corresponding descriptor-table register (LDTR or TR) only from 64-bit mode. In compatibility mode, the legacy system-segment descriptor format, shown in Figure 4-16 on page 86, is used. See “LLDT and LTR Instructions” on page 158 for more information.

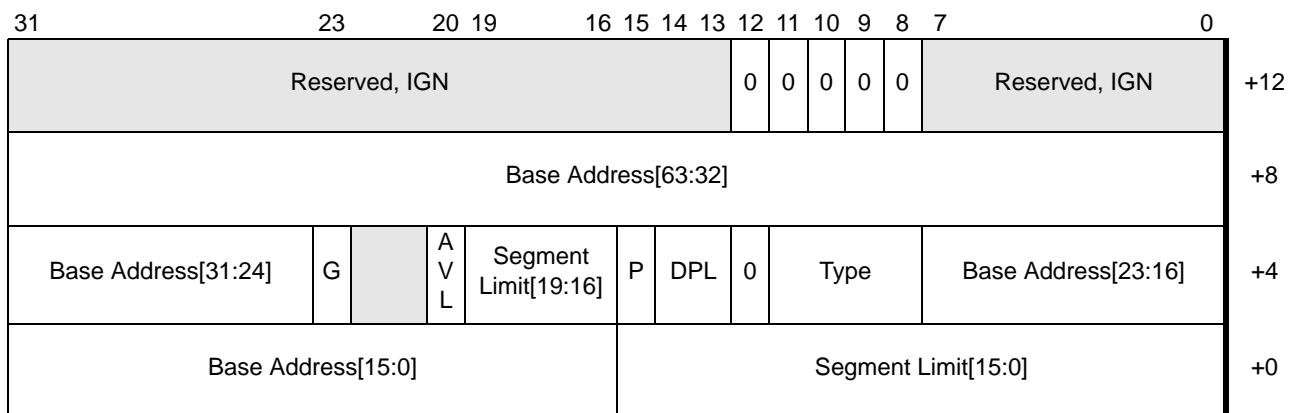
**Figure 4-22. System-Segment Descriptor—64-Bit Mode**

The 64-bit system-segment base address must be in canonical form. Otherwise, a general-protection exception occurs with a selector error-code, #GP(selector), when the system segment is loaded. System-segment limit values are checked by the processor in both 64-bit and compatibility modes, under the control of the granularity (G) bit.

Figure 4-22 shows that bits 12:8 of doubleword +12 must be cleared to 0. These bits correspond to the S and Type fields in a legacy descriptor. Clearing these bits to 0 corresponds to an illegal type in legacy

mode and causes a #GP if an attempt is made to access the upper half of a 64-bit mode system-segment descriptor as a legacy descriptor or as the lower half of a 64-bit mode system-segment descriptor.

### 4.8.4 Gate Descriptors

As shown in Table 4-6 on page 90, the allowable gate-descriptor types are changed in long mode. Some gate-descriptor types are modified and others are illegal. The modified gate-descriptor types in long mode are:

- The 32-bit call gate (0Ch), which is redefined as the 64-bit call gate.
- The 32-bit interrupt gate (0Eh), which is redefined as the 64-bit interrupt gate.
- The 32-bit trap gate (0Fh), which is redefined as the 64-bit trap gate.

In long mode, several gate-descriptor types are illegal. An attempt to use these gates causes a general-protection exception (#GP) to occur. The illegal gate types are:

- The 16-bit call gate (04h).
- The task gate (05h).
- The 16-bit interrupt gate (06h).
- The 16-bit trap gate (07h).

In long mode, gate descriptors are expanded by 64 bits, allowing them to hold 64-bit offsets. The 64-bit call-gate descriptor is shown in Figure 4-23 and the 64-bit interrupt gate and trap gate are shown in Figure 4-24 on page 93. In these figures, gray shading indicates the fields that are *ignored in long mode*. The interrupt and trap gates contain an additional field, the IST, that is not present in the call gate—see “IST Field (Interrupt and Trap Gates)” on page 93.

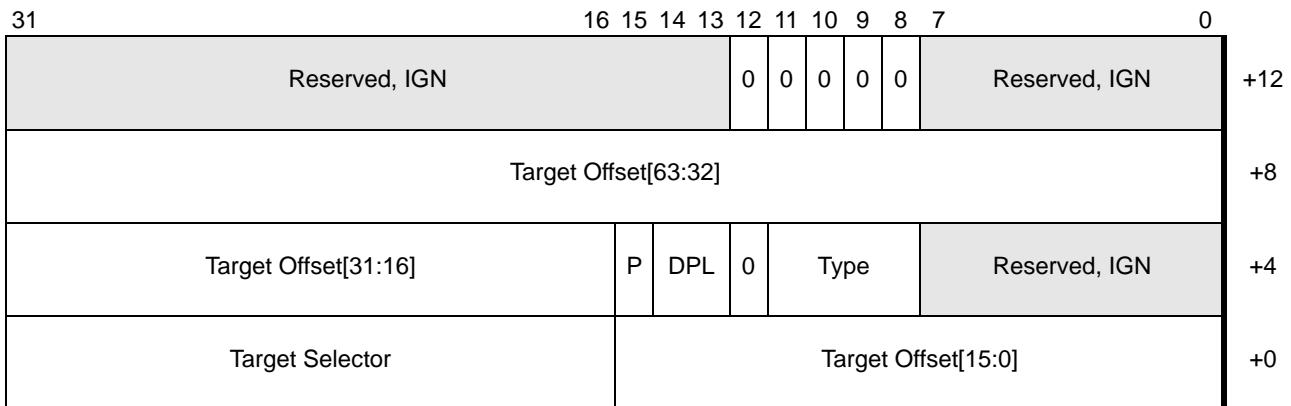
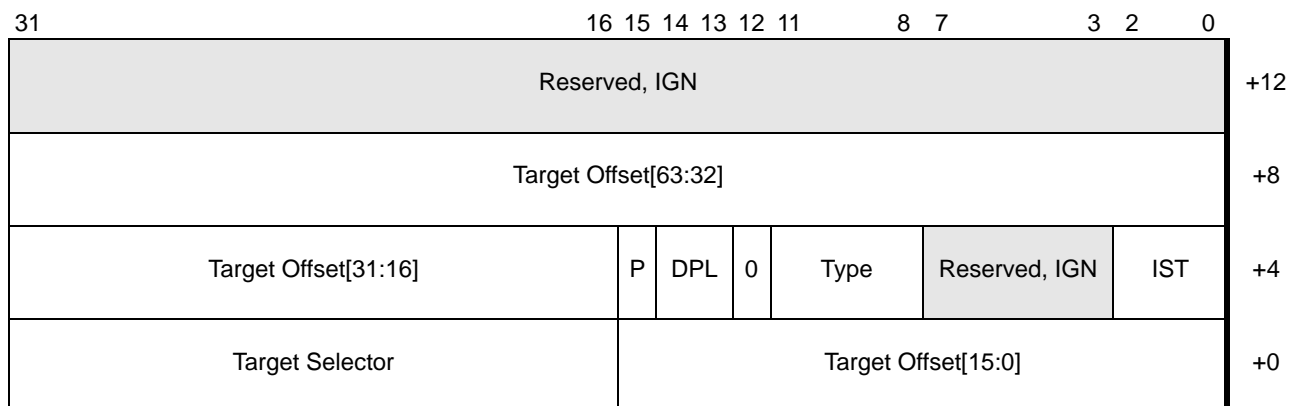

Figure 4-23. Call-Gate Descriptor—Long Mode



**Figure 4-24. Interrupt-Gate and Trap-Gate Descriptors—Long Mode**

The target code segment referenced by a long-mode gate descriptor must be a 64-bit code segment (CS.L=1, CS.D=0). If the target is not a 64-bit code segment, a general-protection exception, #GP(error), occurs. The error code reported depends on the gate type:

- Call gates report the target code-segment selector as the error code.
- Interrupt and trap gates report the interrupt vector number as the error code.

A general-protection exception, #GP(0), occurs if software attempts to reference a long-mode gate descriptor with a target-segment offset that is not in canonical form.

It is possible for software to store legacy and long mode gate descriptors in the same descriptor table. Figure 4-23 on page 92 shows that bits 12:8 of byte +12 in a long-mode call gate must be cleared to 0. These bits correspond to the S and Type fields in a legacy call gate. Clearing these bits to 0 corresponds to an illegal type in legacy mode and causes a #GP if an attempt is made to access the upper half of a 64-bit mode call-gate descriptor as a legacy call-gate descriptor.

It is not necessary to clear these same bits in a long-mode interrupt gate or trap gate. In long mode, the interrupt-descriptor table (IDT) must contain 64-bit interrupt gates or trap gates. The processor automatically indexes the IDT by scaling the interrupt vector by 16. This makes it impossible to access the upper half of a long-mode interrupt gate, or trap gate, as a legacy gate when the processor is running in long mode.

**IST Field (Interrupt and Trap Gates).** Bits 2:0 of byte +4. Long-mode interrupt gate and trap gate descriptors contain a new, 3-bit interrupt-stack-table (IST) field not present in legacy gate descriptors. The IST field is used as an index into the IST portion of a long-mode TSS. If the IST field is not 0, the index references an IST pointer in the TSS, which the processor loads into the RSP register when an interrupt occurs. If the IST index is 0, the processor uses the legacy stack-switching mechanism (with some modifications) when an interrupt occurs. See “Interrupt-Stack Table” on page 251 for more information.

**Count Field (Call Gates).** The count field found in legacy call-gate descriptors is not supported in long-mode call gates. In long mode, the field is reserved and should be cleared to zero.

#### 4.8.5 Long Mode Descriptor Summary

System descriptors and gate descriptors are expanded by 64 bits to handle 64-bit base addresses in long mode or 64-bit mode. The mode in which the expansion occurs depends on the purpose served by the descriptor, as follows:

- *Expansion Only In 64-Bit Mode*—The system descriptors and pseudo-descriptors that are loaded into the GDTR, IDTR, LDTR, and TR registers are expanded only in 64-bit mode. They are not expanded in compatibility mode.
- *Expansion In Long Mode*—Gate descriptors (call gates, interrupt gates, and trap gates) are expanded in long mode (both 64-bit mode and compatibility mode). Task gates and 16-bit gate descriptors are illegal in long mode.

The AMD64 architecture redefines several of the descriptor-entry fields in support of long mode. The specific change depends on whether the processor is in 64-bit mode or compatibility mode. Table 4-7 summarizes the changes in the descriptor entry field when the descriptor entry is loaded into a segment register (as opposed to when the segment register is subsequently used to access memory).

**Table 4-7. Descriptor-Entry Field Changes in Long Mode**

Descriptor Field	Descriptor Type	Long Mode	
		Compatibility Mode	64-Bit Mode
Limit	Code	Same as legacy x86	Same as legacy x86
	Data		
	System		
Offset	Gate	Expanded to 64 bits	Expanded to 64 bits
Base	Code	Same as legacy x86	Same as legacy x86
	Data		
	System		
Selector	Gate	Same as legacy x86	
IST <sup>1</sup>	Gate	Interrupt and trap gates only. (New for long mode.)	
S and Type	Code	Same as legacy x86	Same as legacy x86
	Data		
	System	Types 02h, 09h, and 0Bh redefined Types 01h and 03h are illegal	
	Gate	Types 0Ch, 0Eh, and 0Fh redefined Types 04h–07h are illegal	
<b>Note(s):</b>			
1. Not available (reserved) in legacy mode.			

**Table 4-7. Descriptor-Entry Field Changes in Long Mode (continued)**

Descriptor Field	Descriptor Type	Long Mode	
		Compatibility Mode	64-Bit Mode
DPL	Code	Same as legacy x86	Same as legacy x86
	Data		
	System		
	Gate		
Present	Code	Same as legacy x86	Same as legacy x86
	Data		
	System		
	Gate		
Default Size	Code	Same as legacy x86	D=0 Indicates 64-bit address, 32-bit data D=1 Reserved
	Data		Same as legacy x86
Long <sup>1</sup>	Code	Specifies compatibility mode	Specifies 64-bit mode
Granularity	Code	Same as legacy x86	Same as legacy x86
	Data		
	System		
Available	Code	Same as legacy x86	Same as legacy x86
	Data		
	System		
<b>Note(s):</b> 1. Not available (reserved) in legacy mode.			

## 4.9 Segment-Protection Overview

The AMD64 architecture is designed to fully support the legacy segment-protection mechanism. The segment-protection mechanism provides system software with the ability to restrict program access into other software routines and data.

Segment-level protection remains enabled in compatibility mode. 64-bit mode eliminates most type checking, and limit checking is not performed, except on accesses to system-descriptor tables.

The preferred method of implementing memory protection in a long-mode operating system is to rely on the page-protection mechanism as described in “Page-Protection Checks” on page 145. System software still needs to create basic segment-protection data structures for 64-bit mode. These structures are simplified, however, by the use of the flat-memory model in 64-bit mode, and the limited segmentation checks performed when executing in 64-bit mode.

### 4.9.1 Privilege-Level Concept

Segment protection is used to isolate and protect programs and data from each other. The segment-protection mechanism supports four privilege levels in protected mode. The privilege levels are designated with a numerical value from 0 to 3, with 0 being the most privileged and 3 being the least privileged. System software typically assigns the privilege levels in the following manner:

- *Privilege-level 0 (most privilege)*—This level is used by critical system-software components that require direct access to, and control over, all processor and system resources. This can include platform firmware, memory-management functions, and interrupt handlers.
- *Privilege-levels 1 and 2 (moderate privilege)*—These levels are used by less-critical system-software services that can access and control a limited scope of processor and system resources. Software running at these privilege levels might include some device drivers and library routines. These software routines can call more-privileged system-software services to perform functions such as memory garbage-collection and file allocation.
- *Privilege-level 3 (least privilege)*—This level is used by application software. Software running at privilege-level 3 is normally prevented from directly accessing most processor and system resources. Instead, applications request access to the protected processor and system resources by calling more-privileged service routines to perform the accesses.

Figure 4-25 shows the relationship of the four privilege levels to each other.

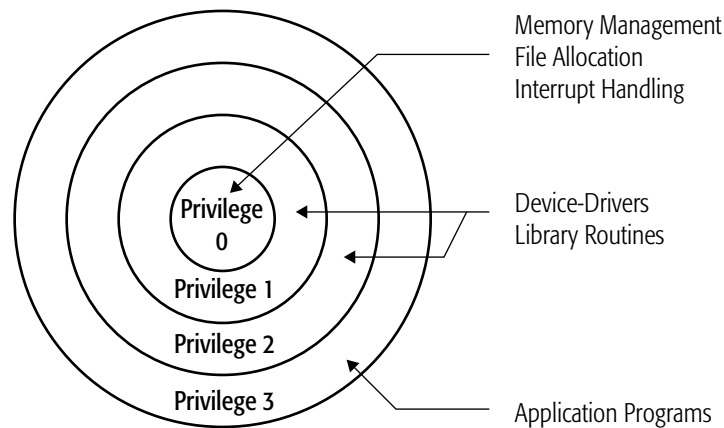

**Figure 4-25. Privilege-Level Relationships**

### 4.9.2 Privilege-Level Types

There are three types of privilege levels the processor uses to control access to segments. These are CPL, DPL, and RPL.

**Current Privilege-Level.** The current privilege-level (CPL) is the privilege level at which the processor is currently executing. The CPL is stored in an internal processor register that is invisible to



software. Software changes the CPL by performing a control transfer to a different code segment with a new privilege level.

**Descriptor Privilege-Level.** The descriptor privilege-level (DPL) is the privilege level that system software assigns to individual segments. The DPL is used in privilege checks to determine whether software can access the segment referenced by the descriptor. In the case of gate descriptors, the DPL determines whether software can access the descriptor reference by the gate. The DPL is stored in the segment (or gate) descriptor.

**Requestor Privilege-Level.** The requestor privilege-level (RPL) reflects the privilege level of the program that created the selector. The RPL can be used to let a called program know the privilege level of the program that initiated the call. The RPL is stored in the selector used to reference the segment (or gate) descriptor.

The following sections describe how the CPL, DPL, and RPL are used by the processor in performing privilege checks on data accesses and control transfers. Failure to pass a protection check generally causes an exception to occur.

## 4.10 Data-Access Privilege Checks

### 4.10.1 Accessing Data Segments

Before loading a data-segment register (DS, ES, FS, or GS) with a segment selector, the processor checks the privilege levels as follows to see if access is allowed:

1. The processor compares the CPL with the RPL in the data-segment selector and determines the effective privilege level for the data access. The processor sets the effective privilege level to the lowest privilege (numerically-higher value) indicated by the comparison.
2. The processor compares the effective privilege level with the DPL in the descriptor-table entry referenced by the segment selector. If the effective privilege level is greater than or equal to (numerically lower-than or equal-to) the DPL, then the processor loads the segment register with the data-segment selector. The processor automatically loads the corresponding descriptor-table entry into the hidden portion of the segment register.

If the effective privilege level is lower than (numerically greater-than) the DPL, a general-protection exception (#GP) occurs and the segment register is not loaded.

Figure 4-26 on page 98 shows two examples of data-access privilege checks.

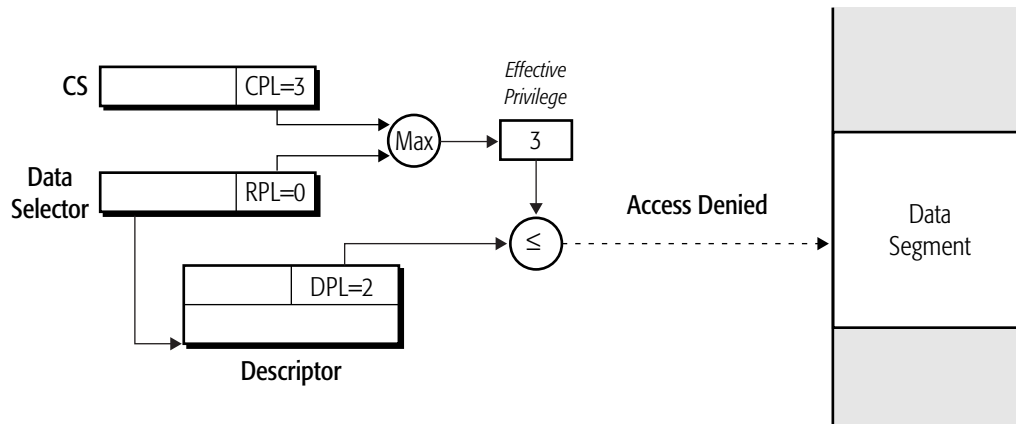

Example 1: Privilege Check Fails

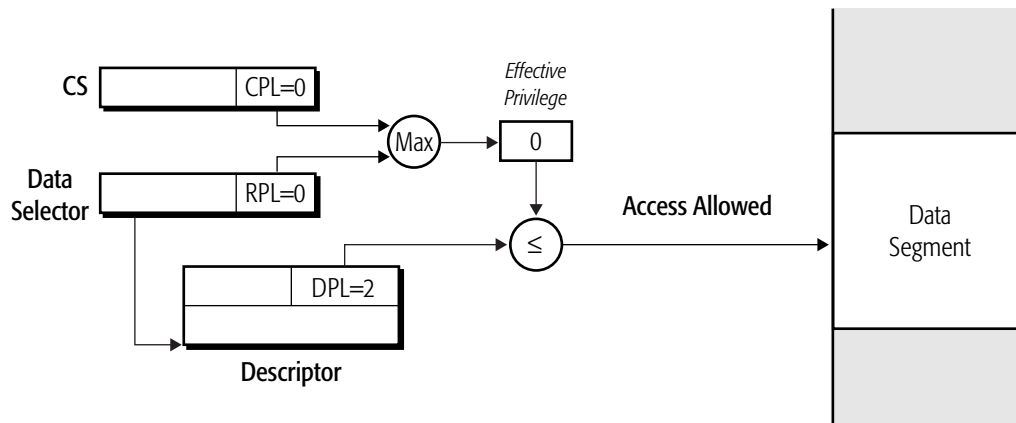

Example 2: Privilege Check Passes

**Figure 4-26. Data-Access Privilege-Check Examples**

Example 1 in Figure 4-26 shows a failing data-access privilege check. The effective privilege level is 3 because  $CPL=3$ . This value is greater than the descriptor  $DPL$ , so access to the data segment is denied.

Example 2 in Figure 4-26 shows a passing data-access privilege check. Here, the effective privilege level is 0 because both the  $CPL$  and  $RPL$  have values of 0. This value is less than the descriptor  $DPL$ , so access to the data segment is allowed, and the data-segment register is successfully loaded.

#### 4.10.2 Accessing Stack Segments

Before loading the stack segment register ( $SS$ ) with a segment selector, the processor checks the privilege levels as follows to see if access is allowed:

1. The processor checks that the CPL and the stack-selector RPL are *equal*. If they are not equal, a general-protection exception (#GP) occurs and the SS register is not loaded.
2. The processor compares the CPL with the DPL in the descriptor-table entry referenced by the segment selector. The two values *must be equal*. If they are not equal, a #GP occurs and the SS register is not loaded.

Figure 4-27 shows two examples of stack-access privilege checks. In Example 1 the CPL, stack-selector RPL, and stack segment-descriptor DPL are all equal, so access to the stack segment using the SS register is allowed. In Example 2, the stack-selector RPL and stack segment-descriptor DPL are both equal. However, the CPL is not equal to the stack segment-descriptor DPL, and access to the stack segment through the SS register is denied.

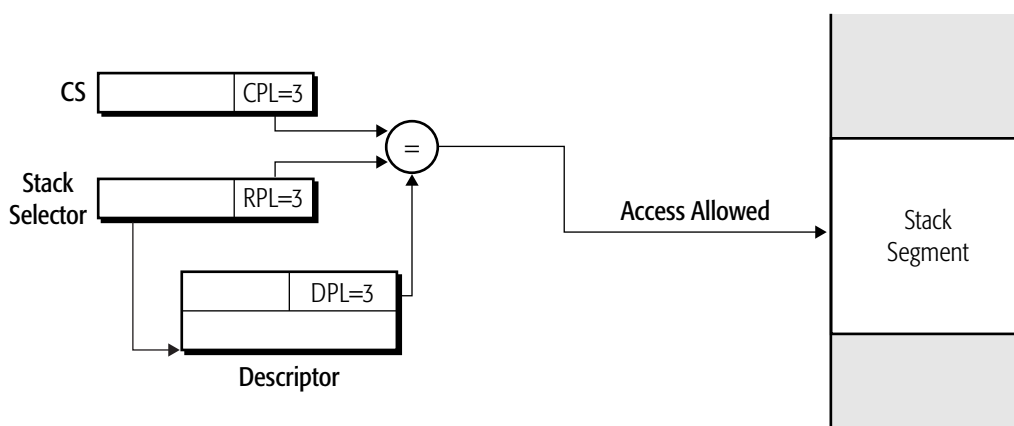

Example 1: Privilege Check Passes

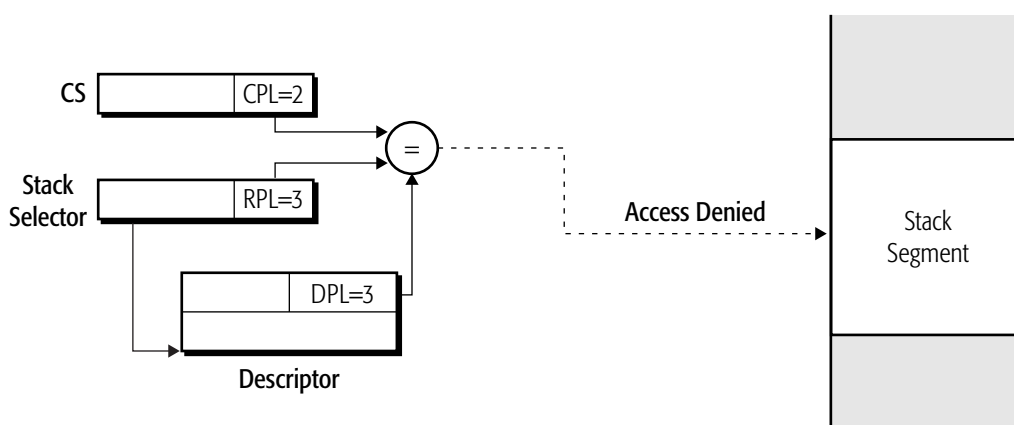

Example 2: Privilege Check Fails

**Figure 4-27. Stack-Access Privilege-Check Examples**

## 4.11 Control-Transfer Privilege Checks

Control transfers between code segments (also called *far control transfers*) cause the processor to perform privilege checks to determine whether the source program is allowed to transfer control to the target program. If the privilege checks pass, access to the target code-segment is granted. When access is granted, the target code-segment selector is loaded into the CS register. The RIP register is updated with the target CS offset taken from either the far-pointer operand or the gate descriptor. Privilege checks are not performed during *near control transfers* because such transfers do not change segments.

The following mechanisms can be used by software to perform far control transfers:

- System-software control transfers using the *system-call* and *system-return* instructions. See “SYSCALL and SYSRET” on page 152 and “SYSENTER and SYSEXIT (Legacy Mode Only)” on page 154 for more information on these instructions. SYSCALL and SYSRET are the preferred method of performing control transfers in long mode. *SYSENTER and SYSEXIT are not supported in long mode.*
- Direct control transfers using CALL and JMP instructions. These are discussed in the next section, “Direct Control Transfers.”
- Call-gate control transfers using CALL and JMP instructions. These are discussed in “Control Transfers Through Call Gates” on page 104.
- Return control transfers using the RET instruction. These are discussed in “Return Control Transfers” on page 111.
- Interrupts and exceptions, including the INT<sub>n</sub> and IRET instructions. These are discussed in Chapter 8, “Exceptions and Interrupts.”
- Task switches initiated by CALL and JMP instructions. Task switches are discussed in Chapter 12, “Task Management.” *The hardware task-switch mechanism is not supported in long mode.*

### 4.11.1 Direct Control Transfers

A *direct control transfer* occurs when software executes a far-CALL or a far-JMP instruction without using a call gate. The privilege checks and type of access allowed as a result of a direct control transfer depends on whether the target code segment is conforming or nonconforming. The code-segment-descriptor conforming (C) bit indicates whether or not the target code-segment is conforming (see “Conforming (C) Bit” on page 82 for more information on the conforming bit).

Privilege levels are not changed as a result of a direct control transfer. Program stacks are not automatically switched by the processor as they are with privilege-changing control transfers through call gates (see “Stack Switching” on page 108 for more information on automatic stack switching during privilege-changing control transfers).

**Nonconforming Code Segments.** Software can perform a direct control transfer to a nonconforming code segment only if the target code-segment descriptor DPL and the CPL are equal and the RPL is less than or equal to the CPL. Software must use a call gate to transfer control to a

more-privileged, nonconforming code segment (see “Control Transfers Through Call Gates” on page 104 for more information).

In far calls and jumps, the far pointer (CS:rIP) references the target code-segment descriptor. Before loading the CS register with a nonconforming code-segment selector, the processor checks as follows to see if access is allowed:

1. *DPL = CPL Check*—The processor compares the target code-segment descriptor DPL with the currently executing program CPL. If they are equal, the processor performs the next check. If they are not equal, a general-protection exception (#GP) occurs.
2. *RPL ≤ CPL Check*—The processor compares the target code-segment selector RPL with the currently executing program CPL. If the RPL is less than or equal to the CPL, access is allowed. If the RPL is greater than the CPL, a #GP exception occurs.

If access is allowed, the processor loads the CS and rIP registers with their new values and begins executing from the target location. The CPL is *not changed*—the target-CS selector RPL value is disregarded when the selector is loaded into the CS register.

Figure 4-28 on page 102 shows three examples of privilege checks performed as a result of a far control transfer to a nonconforming code-segment. In Example 1, access is allowed because  $CPL = DPL$  and  $RPL \leq CPL$ . In Example 2, access is denied because  $CPL \neq DPL$ . In Example 3, access is denied because  $RPL > CPL$ .

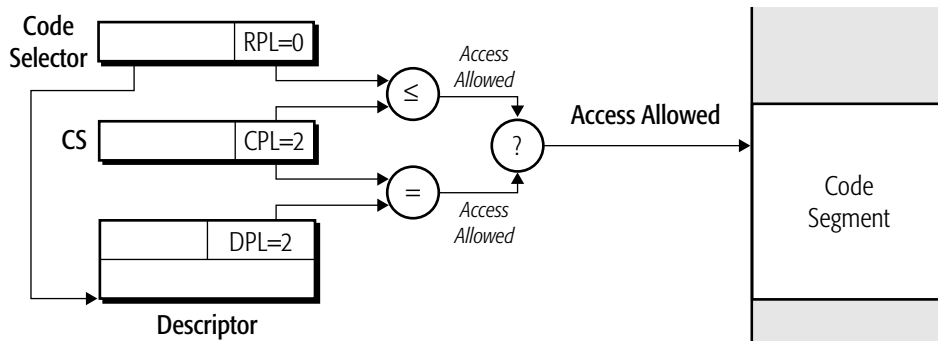

Example 1: Privilege Check Passes

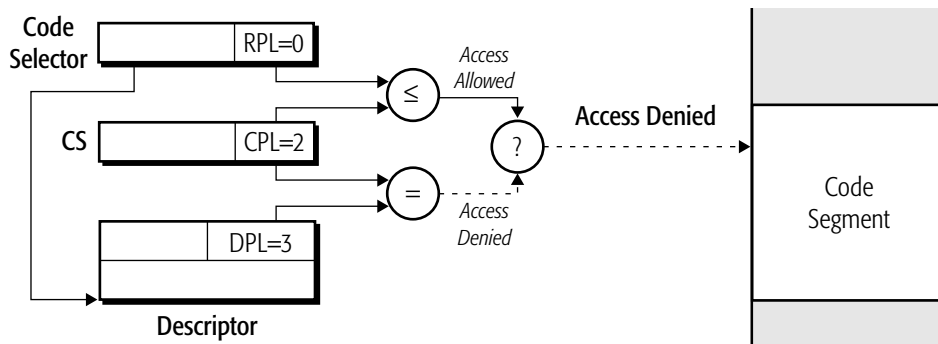

Example 2: Privilege Check Fails

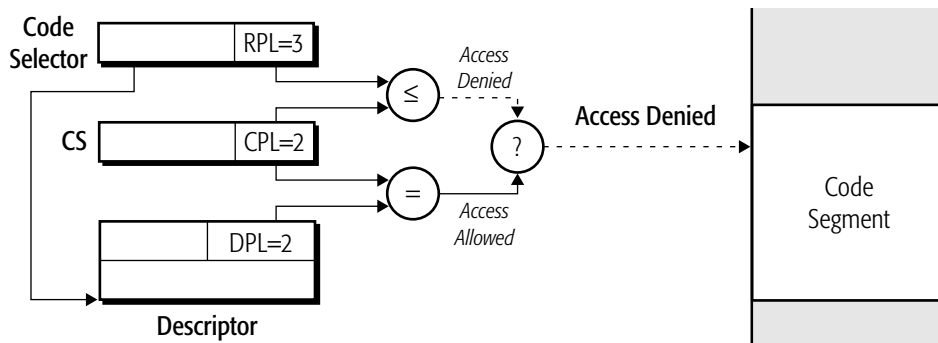

Example 3: Privilege Check Fails

Figure 4-28. Nonconforming Code-Segment Privilege-Check Examples

**Conforming Code Segments.** On a direct control transfer to a conforming code segment, the target code-segment descriptor DPL can be lower than (at a greater privilege) the CPL. Before loading the

CS register with a conforming code-segment selector, the processor compares the target code-segment descriptor DPL with the currently-executing program CPL. If the DPL is less than or equal to the CPL, access is allowed. If the DPL is greater than the CPL, a #GP exception occurs.

On an access to a conforming code segment, the RPL is ignored and not involved in the privilege check.

When access is allowed, the processor loads the CS and rIP registers with their new values and begins executing from the target location. The CPL is *not changed*—the target CS-descriptor DPL value is disregarded when the selector is loaded into the CS register. The target program runs at the same privilege as the program that called it.

Figure 4-29 shows two examples of privilege checks performed as a result of a direct control transfer to a conforming code segment. In Example 1, access is allowed because the CPL of 3 is greater than the DPL of 0. As the target code selector is loaded into the CS register, the old CPL value of 3 replaces the target-code selector RPL value, and the target program executes with CPL=3. In Example 2, access is denied because  $CPL < DPL$ .

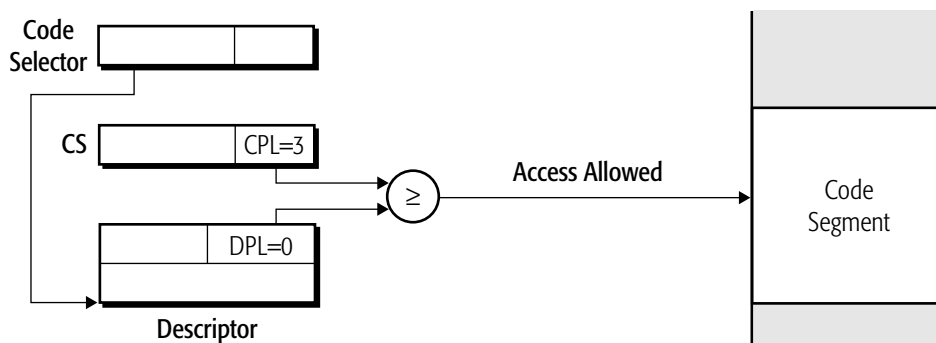

Example 1: Privilege Check Passes

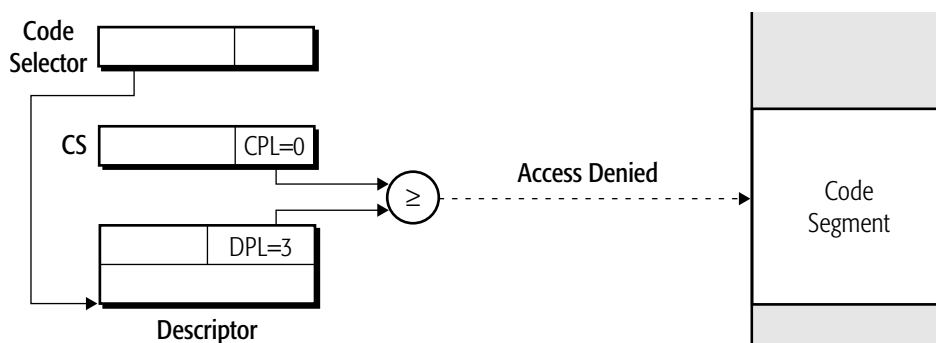

Example 2: Privilege Check Fails

**Figure 4-29. Conforming Code-Segment Privilege-Check Examples**

### 4.11.2 Control Transfers Through Call Gates

Control transfers to more-privileged code segments are accomplished through the use of *call gates*. Call gates are a type of descriptor that contain pointers to code-segment descriptors and control access to those descriptors. System software uses call gates to establish protected entry points into system-service routines.

**Transfer Mechanism.** The pointer operand of a far-CALL or far-JMP instruction consists of two pieces: a code-segment selector (CS) and a code-segment offset (rIP). In a call-gate transfer, the CS selector points to a call-gate descriptor rather than a code-segment descriptor, and the rIP is ignored (but required by the instruction).

Figure 4-30 shows a call-gate control transfer in legacy mode. The call-gate descriptor contains segment-selector and segment-offset fields (see “Gate Descriptors” on page 86 for a detailed description of the call-gate format and fields). These two fields perform the same function as the pointer operand in a direct control-transfer instruction. The segment-selector field points to the target code-segment descriptor, and the segment-offset field is the instruction-pointer offset into the target code-segment. The code-segment base taken from the code-segment descriptor is added to the offset field in the call-gate descriptor to create the target virtual address (linear address).

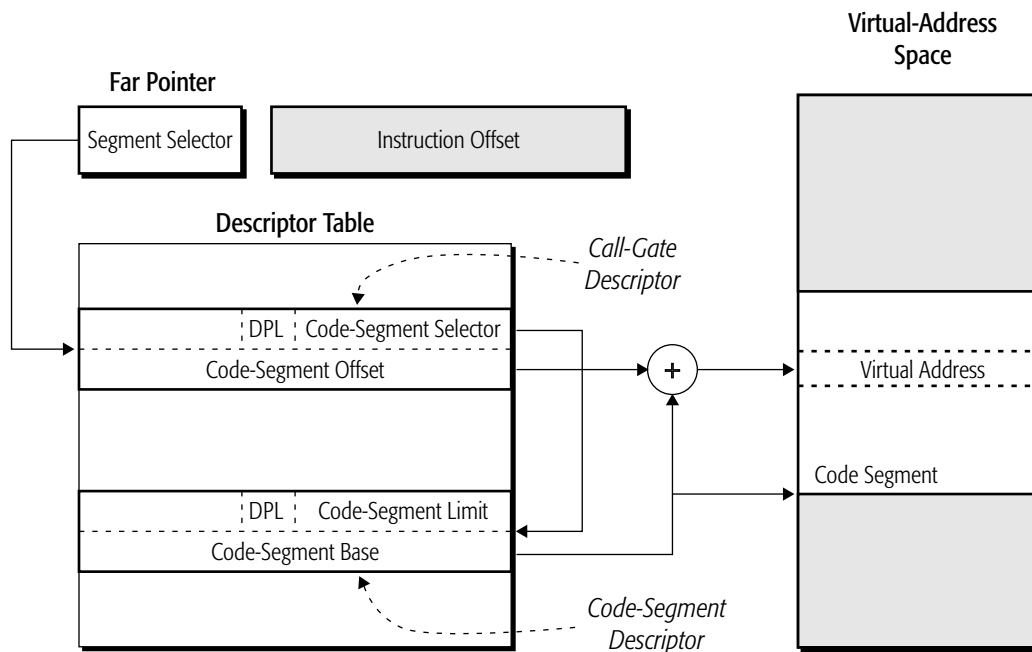

**Figure 4-30. Legacy-Mode Call-Gate Transfer Mechanism**



Figure 4-31 shows a call-gate control transfer in long mode. The long-mode call-gate descriptor format is expanded by 64 bits to hold a full 64-bit offset into the virtual-address space. Only long-mode call gates can be referenced in long mode (64-bit mode and compatibility mode). The legacy-mode 32-bit call-gate types are redefined in long mode as 64-bit types, and 16-bit call-gate types are illegal.

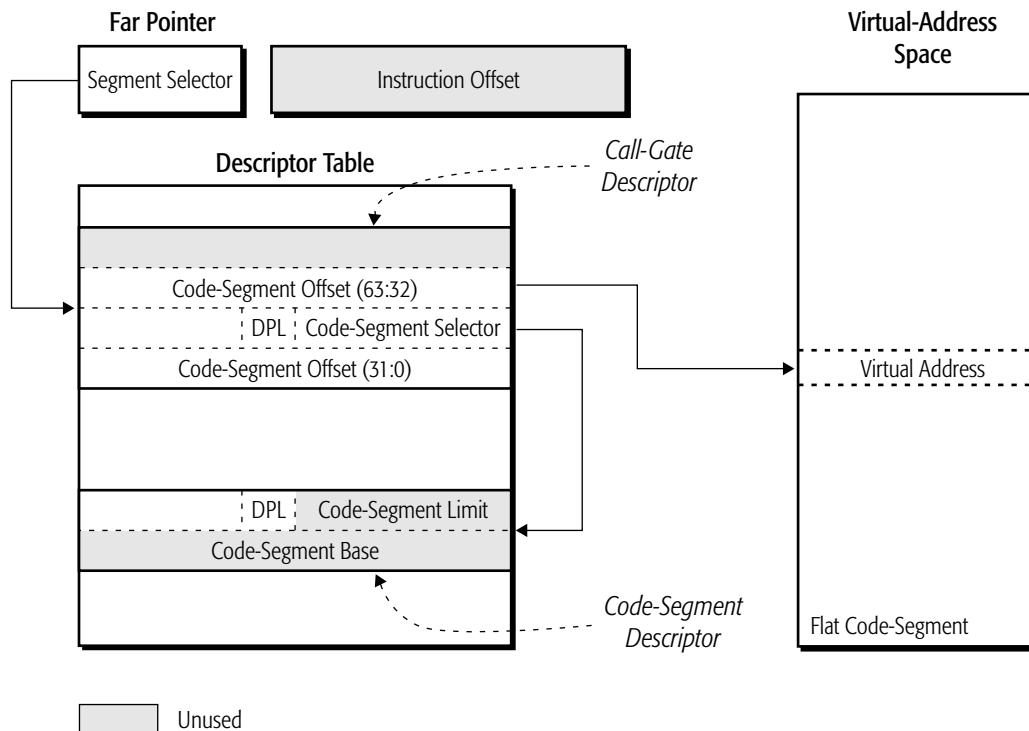

**Figure 4-31. Long-Mode Call-Gate Access Mechanism**

A long-mode call gate must reference a 64-bit code-segment descriptor. In 64-bit mode, the code-segment descriptor base-address and limit fields are ignored. The target virtual-address is the 64-bit offset field in the expanded call-gate descriptor.

**Privilege Checks.** Before loading the CS register with the code-segment selector located in the call gate, the processor performs three privilege checks. The following checks are performed when either conforming or nonconforming code segments are referenced:

1. The processor compares the CPL with the call-gate DPL from the call-gate descriptor ( $DPL_G$ ). The CPL must be numerically *less than or equal to*  $DPL_G$  for this check to pass. In other words, the following expression must be true:  $CPL \leq DPL_G$

2. The processor compares the RPL in the call-gate selector with  $DPL_G$ . The RPL must be numerically *less than or equal to*  $DPL_G$  for this check to pass. In other words, the following expression must be true:  $RPL \leq DPL_G$ .
3. The processor compares the CPL with the target code-segment DPL from the code-segment descriptor ( $DPL_S$ ). The type of comparison varies depending on the type of control transfer.
  - When a call—or a jump to a *conforming* code segment—is used to transfer control through a call gate, the CPL must be numerically *greater than or equal to*  $DPL_S$  for this check to pass. (This check prevents control transfers to less-privileged programs.) In other words, the following expression must be true:  $CPL \geq DPL_S$ .
  - When a JMP instruction is used to transfer control through a call gate to a *nonconforming* code segment, the CPL must be numerically *equal to*  $DPL_S$  for this check to pass. (JMP instructions cannot change CPL.) In other words, the following expression must be true:  $CPL = DPL_S$ .

Figure 4-32 on page 107 shows two examples of call-gate privilege checks. In Example 1, all privilege checks pass as follows:

- The call-gate DPL ( $DPL_G$ ) is at the lowest privilege (3), specifying that software running at any privilege level (CPL) can access the gate.
- The selector referencing the call gate passes its privilege check because the RPL is numerically less than or equal to  $DPL_G$ .
- The target code segment is at the highest privilege level ( $DPL_S = 0$ ). This means software running at any privilege level can access the target code segment through the call gate.

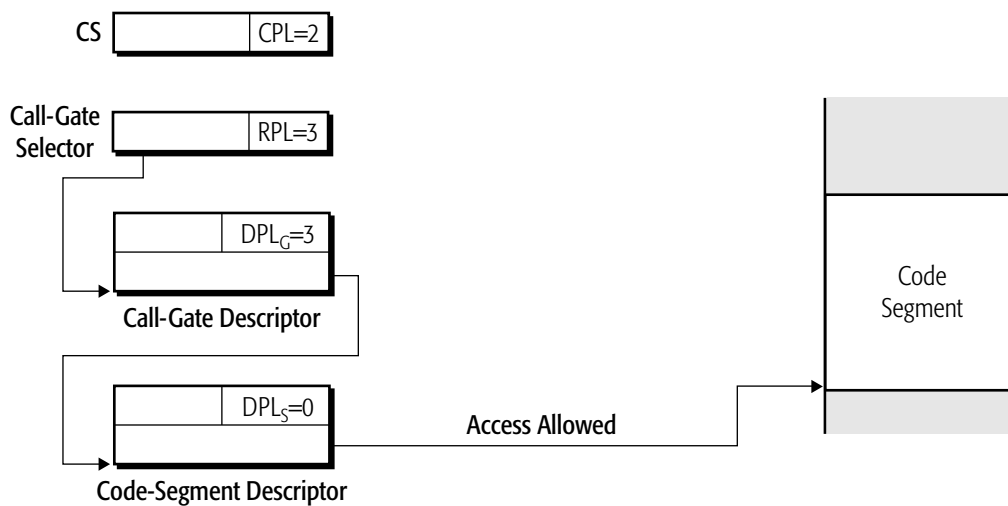

Example 1: Privilege Check Passes

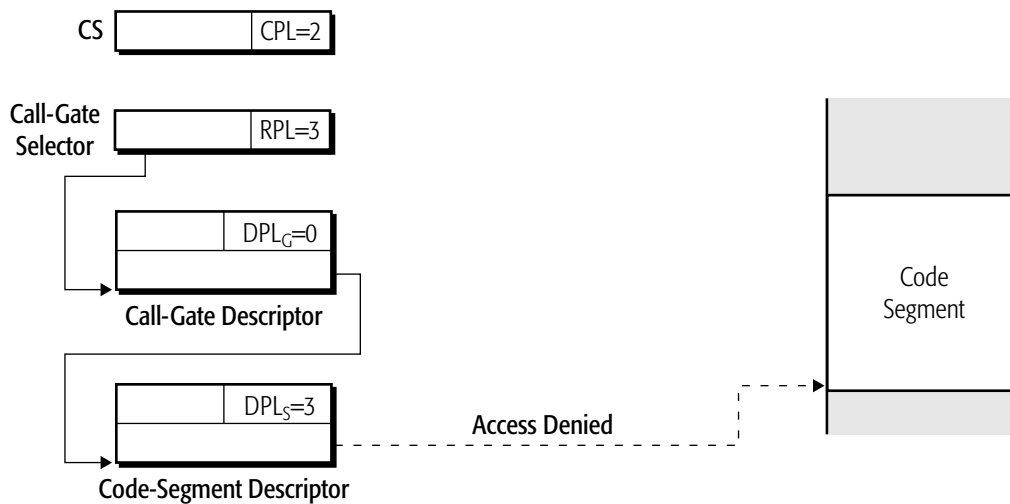

Example 2: Privilege Check Fails

**Figure 4-32. Privilege-Check Examples for Call Gates**

In Example 2, all privilege checks fail as follows:

- The call-gate DPL ( $DPL_G$ ) specifies that only software at privilege-level 0 can access the gate. The current program does not have enough privilege to access the call gate because its CPL is 2.
- The selector referencing the call-gate descriptor does not have enough privilege to complete the reference. Its RPL is numerically greater than  $DPL_G$ .

- The target code segment is at a lower privilege ( $DPL_S = 3$ ) than the currently running software ( $CPL = 2$ ). Transitions from more-privileged software to less-privileged software are not allowed, so this privilege check fails as well.

Although all three privilege checks failed in Example 2, failing only one check is sufficient to deny access into the target code segment.

**Stack Switching.** The processor performs an automatic stack switch when a control transfer causes a change in privilege levels to occur. Switching stacks isolates more-privileged software stacks from less-privileged software stacks and provides a mechanism for saving the return pointer back to the program that initiated the call.

When switching to more-privileged software, as is done when transferring control using a call gate, the processor uses the corresponding stack pointer (privilege-level 0, 1, or 2) stored in the task-state segment (TSS). The format of the stack pointer stored in the TSS depends on the system-software operating mode:

- Legacy-mode system software stores a 32-bit ESP value (stack offset) and 16-bit SS selector register value in the TSS for each of three privilege levels 0, 1, and 2.
- Long-mode system software stores a 64-bit RSP value in the TSS for privilege levels 0, 1, and 2. No SS register value is stored in the TSS because in long mode a call gate *must* reference a 64-bit code-segment descriptor. 64-bit mode does not use segmentation, and the stack pointer consists solely of the 64-bit RSP. Any value loaded in the SS register is ignored.

See “Task-Management Resources” on page 328 for more information on the legacy-mode and long-mode TSS formats.

Figure 4-33 on page 109 shows a 32-bit stack in legacy mode before and after the automatic stack switch. This particular example assumes that parameters are passed from the current program to the target program. The process followed by legacy mode in switching stacks and copying parameters is:

1. The target code-segment DPL is read by the processor and used as an index into the TSS for selecting the new stack pointer (SS:ESP). For example, if  $DPL=1$  the processor selects the SS:ESP for privilege-level 1 from the TSS.
2. The SS and ESP registers are loaded with the new SS:ESP values read from the TSS.
3. The old values of the SS and ESP registers are pushed onto the stack pointed to by the new SS:ESP.
4. The 5-bit count field is read from the call-gate descriptor.
5. The number of parameters specified in the count field (up to 31) are copied from the old stack to the new stack. The size of the parameters copied by the processor depends on the call-gate size: 32-bit call gates copy 4-byte parameters and 16-bit call gates copy 2-byte parameters.
6. The return pointer is pushed onto the stack. The return pointer consists of the current CS-register value and the EIP of the instruction following the calling instruction.

7. The CS register is loaded from the segment-selector field in the call-gate descriptor, and the EIP is loaded from the offset field in the call-gate descriptor.
8. The target program begins executing with the instruction referenced by new CS:EIP.

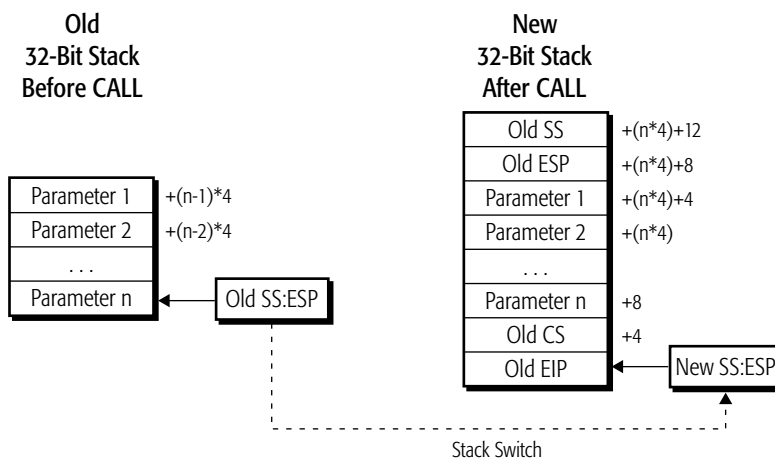

**Figure 4-33. Legacy-Mode 32-Bit Stack Switch, with Parameters**

Figure 4-34 shows a 32-bit stack in legacy mode before and after the automatic stack switch when no parameters are passed (count=0). Most software does not use the call-gate descriptor count-field to pass parameters. System software typically defines linkage mechanisms that do not rely on automatic parameter copying.

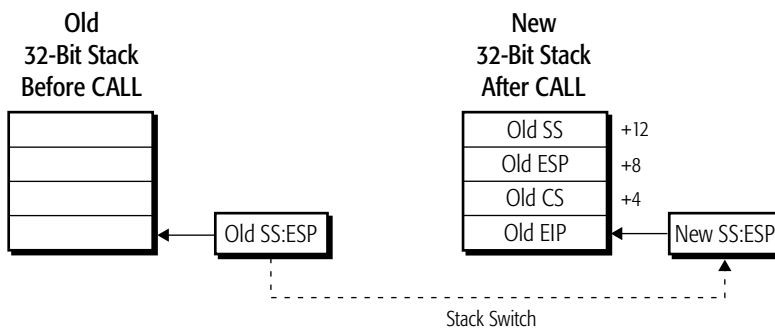

**Figure 4-34. 32-Bit Stack Switch, No Parameters—Legacy Mode**

Figure 4-35 on page 110 shows a long-mode stack switch. In long mode, all call gates *must* reference 64-bit code-segment descriptors, so a long-mode stack switch uses a 64-bit stack. The process of

switching stacks in long mode is similar to switching in legacy mode when no parameters are passed. The process is as follows:

1. The target code-segment DPL is read by the processor and used as an index into the 64-bit TSS for selecting the new stack pointer (RSP).
2. The RSP register is loaded with the new RSP value read from the TSS. The SS register is loaded with a null selector ( $SS=0$ ). Setting the new SS selector to null allows proper handling of nested control transfers in 64-bit mode. See “Nested Returns to 64-Bit Mode Procedures” on page 112 for additional information.

As in legacy mode, it is desirable to keep the stack-segment requestor privilege-level (SS.RPL) equal to the current privilege-level (CPL). When using a call gate to change privilege levels, the SS.RPL is updated to reflect the new CPL. The SS.RPL is restored from the return-target CS.RPL on the subsequent privilege-level-changing far return.

3. The old values of the SS and RSP registers are pushed onto the stack pointed to by the new RSP. The old SS value is popped on a subsequent far return. This allows system software to set up the SS selector for a compatibility-mode process by executing a RET (or IRET) that changes the privilege level.
4. The return pointer is pushed onto the stack. The return pointer consists of the current CS-register value and the RIP of the instruction following the calling instruction.
5. The CS register is loaded from the segment-selector field in the long-mode call-gate descriptor, and the RIP is loaded from the offset field in the long-mode call-gate descriptor.

The target program begins execution with the instruction referenced by the new RIP.

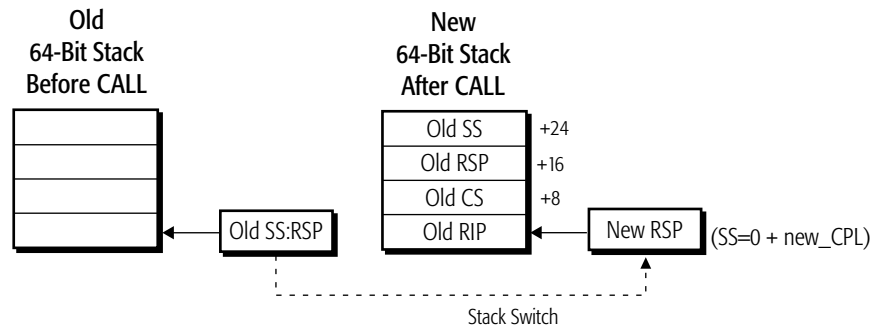

**Figure 4-35. Stack Switch—Long Mode**

All long-mode stack pushes resulting from a privilege-level-changing far call are eight-bytes wide and increment the RSP by eight. Long mode ignores the call-gate count field and does not support the automatic parameter-copy feature found in legacy mode. Software can access parameters on the old stack, if necessary, by referencing the old stack segment selector and stack pointer saved on the new process stack.

### 4.11.3 Return Control Transfers

Returns to calling programs can be performed by using the RET instruction. The following types of returns are possible:

- *Near Return*—Near returns perform control transfers within the same code segment, so the CS register is unchanged. The new offset is popped off the stack and into the rIP register. No privilege checks are performed.
- *Far Return, Same Privilege*—A far return transfers control from one code segment to another. When the original code segment is at the same privilege level as the target code segment, a far pointer (CS:rIP) is popped off the stack and the RPL of the new code segment (CS) is checked. If the requested privilege level (RPL) matches the current privilege level (CPL), then a return is made to the same privilege level. This prevents software from changing the CS value on the stack in an attempt to return to higher-privilege software.
- *Far Return, Less Privilege*—Far returns can change privilege levels, but only to a *lower*-privilege level. In this case a stack switch is performed between the current, higher-privilege program and the lower-privilege return program. The CS-register and rIP-register values are popped off the stack. The lower-privilege stack pointer is also popped off the stack and into the SS register and rSP register. The processor checks both the CS and SS privilege levels to ensure they are equal and at a lesser privilege than the current CS.

In the case of nested returns to 64-bit mode, a null selector can be popped into the SS register. See “Nested Returns to 64-Bit Mode Procedures” on page 112.

Far returns also check the privilege levels of the DS, ES, FS and GS selector registers. If any of these segment registers have a selector with a higher privilege than the return program, the segment register is loaded with the null selector.

**Stack Switching.** The stack switch performed by a far return to a lower-privilege level reverses the stack switch of a call gate to a higher-privilege level, except that parameters are never automatically copied as part of a return. The process followed by a far-return stack switch in long mode and legacy mode is:

1. The return code-segment RPL is read by the processor from the CS value stored on the stack to determine that a lower-privilege control transfer is occurring.
2. The return-program instruction pointer is popped off the current-program (higher privilege) stack and loaded into the CS and rIP registers.
3. The return instruction can include an immediate operand that specifies the number of additional bytes to be popped off of the stack. These bytes may correspond to the parameters pushed onto the stack previously by a call through a call gate containing a non-zero parameter-count field. If the return includes the immediate operand, then the stack pointer is adjusted upward by adding the specified number of bytes to the rSP.
4. The return-program stack pointer is popped off the current-program (higher privilege) stack and loaded into the SS and rSP registers. In the case of nested returns to 64-bit mode, a null selector can be popped into the SS register.

The operand size of a far return determines the size of stack pops when switching stacks. If a far return is used in 64-bit mode to return from a prior call through a long-mode call gate, the far return must use a 64-bit operand size. The 64-bit operand size allows the far return to properly read the stack established previously by the far call.

**Nested Returns to 64-Bit Mode Procedures.** In long mode, a far call that changes privilege levels causes the SS register to be loaded with a null selector (this is the same action taken by an interrupt in long mode). If the called procedure performs another far call to a higher-privileged procedure, or is interrupted, the null SS selector is pushed onto the stack frame, and another null selector is loaded into the SS register. Using a null selector in this way allows the processor to properly handle returns nested within 64-bit-mode procedures and interrupt handlers.

Normally, a RET that pops a null selector into the SS register causes a general-protection exception (#GP) to occur. However, in long mode, the null selector acts as a flag indicating the existence of nested interrupt handlers or other privileged software in 64-bit mode. Long mode allows RET to pop a null selector into SS from the stack under the following conditions:

- The target mode is 64-bit mode.
- The target CPL is less than 3.

In this case, the processor does not load an SS descriptor, and the null selector is loaded into SS without causing a #GP exception.

## 4.12 Limit Checks

Except in 64-bit mode, limit checks are performed by all instructions that reference memory. Limit checks detect attempts to access memory outside the current segment boundary, attempts at executing instructions outside the current code segment, and indexing outside the current descriptor table. If an instruction fails a limit check, either (1) a general-protection exception occurs for all other segment-limit violations or (2) a stack-fault exception occurs for stack-segment limit violations.

In 64-bit mode, segment limits are *not checked* during accesses to any segment referenced by the CS, DS, ES, FS, GS, and SS selector registers. Instead, the processor checks that the virtual addresses used to reference memory are in canonical-address form. In 64-bit mode, as with legacy mode and compatibility mode, descriptor-table limits *are checked*.

### 4.12.1 Determining Limit Violations

To determine segment-limit violations, the processor checks a virtual (linear) address to see if it falls outside the valid range of segment offsets determined by the segment-limit field in the descriptor. If any part of an operand or instruction falls outside the segment-offset range, a limit violation occurs. For example, a doubleword access, two bytes from an upper segment boundary, causes a segment violation because half of the doubleword is outside the segment.



Three bits from the descriptor entry are used to control how the segment-limit field is interpreted: the granularity (G) bit, the default operand-size (D) bit, and for data segments, the expand-down (E) bit. See “Legacy Segment Descriptors” on page 80 for a detailed description of each bit.

For all segments other than expand-down segments, the minimum segment-offset is 0. The maximum segment-offset depends on the value of the G bit:

- If G=0 (byte granularity), the maximum allowable segment-offset is equal to the value of the segment-limit field.
- If G=1 (4096-byte granularity), the segment-limit field is first scaled by 4096 (1000h). Then 4095 (0FFFh) is added to the scaled value to arrive at the maximum allowable segment-offset, as shown in the following equation:

$$\text{maximum segment-offset} = (\text{limit} \times 1000\text{h}) + 0\text{FFFh}$$

For example, if the segment-limit field is 0100h, then the maximum allowable segment-offset is  $(0100\text{h} \times 1000\text{h}) + 0\text{FFFh} = 10\_1\text{FFFh}$ .

In both cases, the maximum segment-size is specified when the descriptor segment-limit field is 0F\_FFFFh.

**Expand-Down Segments.** Expand-down data segments are supported in legacy mode and compatibility mode but not in 64-bit mode. With expand-down data segments, the maximum segment offset depends on the value of the D bit in the data-segment descriptor:

- If D=0 the maximum segment-offset is 0\_FFFFh.
- If D=1 the maximum segment-offset is 0\_FFFF\_FFFFh.

The minimum allowable segment offset in expand-down segments depends on the value of the G bit:

- If G=0 (byte granularity), the minimum allowable segment offset is the segment-limit value plus 1. For example, if the segment-limit field is 0100h, then the minimum allowable segment-offset is 0101h.
- If G=1 (4096-byte granularity), the segment-limit value in the descriptor is first scaled by 4096 (1000h), and then 4095 (0FFFh) is added to the scaled value to arrive at a scaled segment-limit value. The minimum allowable segment-offset is this scaled segment-limit value plus 1, as shown in the following equation:

$$\text{minimum segment-offset} = (\text{limit} \times 1000) + 0\text{FFFh} + 1$$

For example, if the segment-limit field is 0100h, then the minimum allowable segment-offset is  $(0100\text{h} \times 1000\text{h}) + 0\text{FFFh} + 1 = 10\_1000\text{h}$ .

For expand-down segments, the maximum segment size is specified when the segment-limit value is 0.

### 4.12.2 Data Limit Checks in 64-bit Mode

In 64-bit mode, data reads and writes are not normally checked for segment-limit violations. When `EFER.LMSLE = 1`, reads and writes in 64-bit mode at `CPL > 0`, using the DS, ES, FS, or SS segments, have a segment-limit check applied.

This limit-check uses the 32-bit segment-limit to find the maximum allowable address in the top 4GB of the 64-bit virtual (linear) address space.

**Table 4-8. Segment Limit Checks in 64-Bit Mode**

Memory Address	Effect of Limit Check
Linear Address $\leq$ (0FFFFFFFF_00000000h + 32-bit Limit)	Access OK.
Linear Address $>$ (0FFFFFFFF_00000000h + 32-bit Limit)	Exception (#GP or #SS)

This segment-limit check does not apply to accesses through the GS segment, or to code reads. If the DS, ES, FS, or SS segment is null or expand-down, the effect of the limit check is undefined.

## 4.13 Type Checks

Type checks prevent software from using descriptors in invalid ways. Failing a type check results in an exception. Type checks are performed using five bits from the descriptor entry: the S bit and the 4-bit Type field. Together, these five bits are used to specify the descriptor type (code, data, segment, or gate) and its access characteristics. See “Legacy Segment Descriptors” on page 80 for a detailed description of the S bit and Type-field encodings. Type checks are performed by the processor in compatibility mode as well as legacy mode. Limited type checks are performed in 64-bit mode.

### 4.13.1 Type Checks in Legacy and Compatibility Modes

The type checks performed in legacy mode and compatibility mode are listed in the following sections.

**Descriptor-Table Register Loads.** Loads into the LDTR and TR descriptor-table registers are checked for the appropriate system-segment type. The LDTR can only be loaded with an LDT descriptor, and the TR only with a TSS descriptor. The checks are performed during any action that causes these registers to be loaded. This includes execution of the LLDT and LTR instructions and during task switches.

**Segment Register Loads.** The following restrictions are placed on the segment-descriptor types that can be loaded into the six user segment registers:

- Only code segments can be loaded into the CS register.
- Only writable data segments can be loaded into the SS register.
- Only the following segment types can be loaded into the DS, ES, FS, or GS registers:
  - Read-only or read/write data segments.
  - Readable code segments.

These checks are performed during any action that causes the segment registers to be loaded. This includes execution of the MOV segment-register instructions, control transfers, and task switches.

**Control Transfers.** Control transfers (branches and interrupts) place additional restrictions on the segment types that can be referenced during the transfer:

- The segment-descriptor type referenced by far CALLs and far JMPs must be one of the following:
  - A code segment
  - A call gate or a task gate
  - An available TSS (only allowed in legacy mode)
  - A task gate (only allowed in legacy mode)
- Only code-segment descriptors can be referenced by call-gate, interrupt-gate, and trap-gate descriptors.
- Only TSS descriptors can be referenced by task-gate descriptors.
- The link field (selector) in the TSS can only point to a TSS descriptor. This is checked during an IRET control transfer to a task.
- The far RET and far IRET instructions can only reference code-segment descriptors.
- The interrupt-descriptor table (IDT), which is referenced during interrupt control transfers, can only contain interrupt gates, trap gates, and task gates.

**Segment Access.** After a segment descriptor is successfully loaded into one of the segment registers, reads and writes into the segments are restricted in the following ways:

- Writes are not allowed into read-only data-segment types.
- Writes are not allowed into code-segment types (executable segments).
- Reads from code-segment types are not allowed if the readable (R) type bit is cleared to 0.

These checks are generally performed during execution of instructions that access memory.

#### 4.13.2 Long Mode Type Check Differences

**Compatibility Mode and 64-Bit Mode.** The following type checks differ in long mode (64-bit mode and compatibility mode) as compared to legacy mode:

- *System Segments*—System-segment types are checked, but the following types that are valid in legacy mode are illegal in long mode:
  - 16-bit available TSS.
  - 16-bit busy TSS.
  - Type-field encoding of 00h in the upper half of a system-segment descriptor to indicate an illegal type and prevent access as a legacy descriptor.
- *Gates*—Gate-descriptor types are checked, but the following types that are valid in legacy mode are illegal in long mode:

- 16-bit call gate.
- 16-bit interrupt gate.
- 16-bit trap gate.
- Task gate.

**64-Bit Mode.** 64-bit mode disables segmentation, and most of the segment-descriptor fields are ignored. The following list identifies situations where type checks in 64-bit mode differ from those in compatibility mode and legacy mode:

- *Code Segments*—The readable (R) type bit is ignored in 64-bit mode. None of the legacy type-checks that prevent reads from or writes into code segments are performed in 64-bit mode.
- *Data Segments*—Data-segment type attributes are ignored in 64-bit mode. The writable (W) and expand-down (E) type bits are ignored. All data segments are treated as writable.

## 5 Page Translation and Protection

---

The x86 page-translation mechanism (or simply *paging mechanism*) enables system software to create separate address spaces for each process or application. These address spaces are known as *virtual-address* spaces. System software uses the paging mechanism to selectively map individual pages of physical memory into the virtual-address space using a set of hierarchical address-translation tables known collectively as *page tables*.

The paging mechanism and the page tables are used to provide each process with its own private region of physical memory for storing its code and data. Processes can be protected from each other by isolating them within the virtual-address space. A process cannot access physical memory that is not mapped into its virtual-address space by system software.

System software can use the paging mechanism to selectively map physical-memory pages into multiple virtual-address spaces. Mapping physical pages in this manner allows them to be shared by multiple processes and applications. The physical pages can be configured by the page tables to allow read-only access. This prevents applications from altering the pages and ensures their integrity for use by all applications.

Shared mapping is typically used to allow access of shared-library routines by multiple applications. A read-only copy of the library routine is mapped to each application virtual-address space, but only a single copy of the library routine is present in physical memory. This capability also allows a copy of the operating-system kernel and various device drivers to reside within the application address space. Applications are provided with efficient access to system services without requiring costly address-space switches.

The system-software portion of the address space necessarily includes system-only data areas that must be protected from accesses by applications. System software uses the page tables to protect this memory by designating the pages as *supervisor* pages. Such pages are only accessible by system software.

When the supervisor mode execution prevention (SMEP) feature is supported and enabled, attempted instruction fetches from user-mode accessible pages while in supervisor-mode triggers a page fault (#PF). This protects the integrity of system software by preventing the execution of instructions at a supervisor privilege level (CPL < 3) when these instructions could have been written or modified by user-mode code.

Finally, system software can use the paging mechanism to map multiple, large virtual-address spaces into a much smaller amount of physical memory. Each application can use the entire 32-bit or 64-bit virtual-address space. System software actively maps the most-frequently-used virtual-memory pages into the available pool of physical-memory pages. The least-frequently-used virtual-memory pages are swapped out to the hard drive. This process is known as *demand-paged virtual memory*.

## 5.1 Page Translation Overview

The legacy x86 architecture provides support for translating 32-bit virtual addresses into 32-bit physical addresses (larger physical addresses, such as 36-bit or 40-bit addresses, are supported as a special mode). The AMD64 architecture enhances this support to allow translation of 64-bit virtual addresses into 52-bit physical addresses, although processor implementations can support smaller virtual-address and physical-address spaces.

Virtual addresses are translated to physical addresses through hierarchical translation tables created and managed by system software. Each table contains a set of entries that point to the next-lower table in the translation hierarchy. A single table at one level of the hierarchy can have hundreds of entries, each of which points to a unique table at the next-lower hierarchical level. Each lower-level table can in turn have hundreds of entries pointing to tables further down the hierarchy. The lowest-level table in the hierarchy points to the translated physical page.

Figure 5-1 on page 119 shows an overview of the page-translation hierarchy used in long mode. Legacy mode paging uses a subset of this translation hierarchy (the page-map level-4 table does not exist in legacy mode and the PDP table may or may not be used, depending on which paging mode is enabled). As this figure shows, a virtual address is divided into fields, each of which is used as an offset into a translation table. The complete translation chain is made up of all table entries referenced by the virtual-address fields. The lowest-order virtual-address bits are used as the byte offset into the physical page.

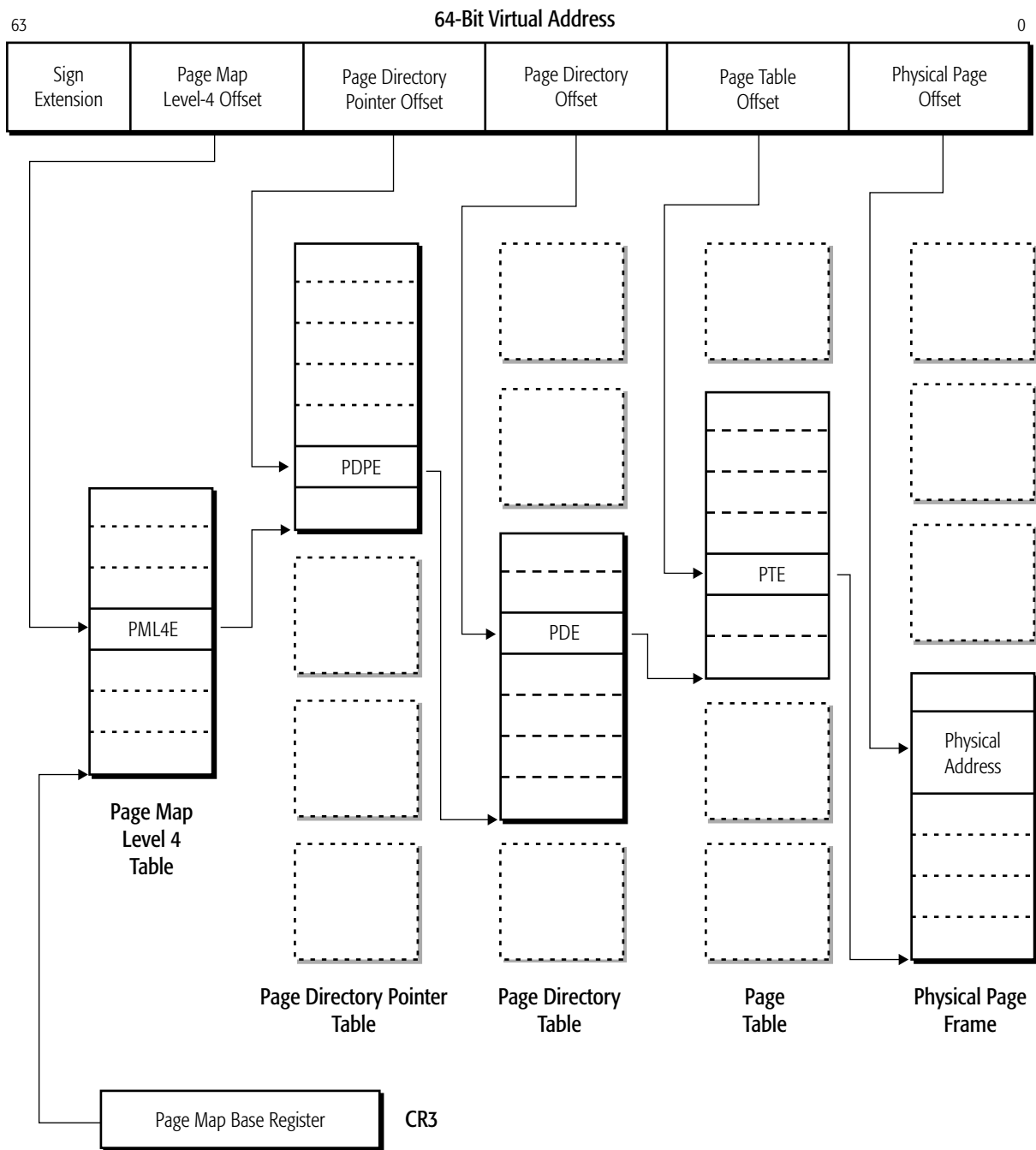

**Figure 5-1. Virtual to Physical Address Translation—Long Mode**

The following physical-page sizes are supported: 4 Kbytes, 2 Mbytes, 4 Mbytes, and 1 Gbytes. In long mode 4-Kbyte, 2-MByte, and 1-GByte sizes are available. In legacy mode 4-Kbyte, 2-MByte, and 4-MByte sizes are available.

Virtual addresses are 32 bits long, and physical addresses up to the supported physical-address size can be used. The AMD64 architecture enhances the legacy translation support by allowing virtual addresses of up to 64 bits long to be translated into physical addresses of up to 52 bits long.

Currently, the AMD64 architecture defines a mechanism for translating 48-bit virtual addresses to 52-bit physical addresses. The mechanism used to translate a full 64-bit virtual address is reserved and will be described in a future AMD64 architectural specification.

### 5.1.1 Page-Translation Options

The form of page-translation support available to software depends on which paging features are enabled. Four controls are available for selecting the various paging alternatives:

- Page-Translation Enable (CR0.PG)
- Physical-Address Extensions (CR4.PAE)
- Page-Size Extensions (CR4.PSE)
- Long-Mode Active (EFER.LMA)

Not all paging alternatives are available in all modes. Table 5-1 summarizes the paging support available in each mode.

**Table 5-1. Supported Paging Alternatives (CR0.PG=1)**

Mode		Physical-Address Extensions (CR4.PAE)	Page-Size Extensions (CR4.PSE)	Page-Directory Pointer Offset	Page-Directory Page Size	Resulting Physical-Page Size	Maximum Virtual Address	Maximum Physical Address
Long Mode	64-Bit Mode	Enabled	–	PDPE.PS=0	PDE.PS=0	4 Kbyte	64-bit	52-bit
	Compatibility Mode				PDE.PS=1	2 Mbyte		
					PDPE.PS=1	–		
Legacy Mode		Enabled	–	PDPE.PS=0	PDE.PS=0	4 Kbyte	32-bit	52-bit
					PDE.PS=1	2 Mbyte		52-bit
		Disabled	Disabled		–	4 Kbyte		32-bit
			Enabled		PDE.PS=0	4 Kbyte		32-bit
					PDE.PS=1	4 Mbyte		40-bit

### 5.1.2 Page-Translation Enable (PG) Bit

Page translation is controlled by the PG bit in CR0 (bit 31). When CR0.PG is set to 1, page translation is enabled. When CR0.PG is cleared to 0, page translation is disabled.



The AMD64 architecture uses CR0.PG to activate and deactivate long mode when long mode is enabled. See “Enabling and Activating Long Mode” on page 436 for more information.

### 5.1.3 Physical-Address Extensions (PAE) Bit

Physical-address extensions are controlled by the PAE bit in CR4 (bit 5). When CR4.PAE is set to 1, physical-address extensions are enabled. When CR4.PAE is cleared to 0, physical-address extensions are disabled.

Setting CR4.PAE = 1 enables virtual addresses to be translated into physical addresses up to 52 bits long. This is accomplished by doubling the size of paging data-structure entries from 32 bits to 64 bits to accommodate the larger physical base-addresses for physical-pages.

PAE must be enabled before activating long mode. See “Enabling and Activating Long Mode” on page 436.

### 5.1.4 Page-Size Extensions (PSE) Bit

Page-size extensions are controlled by the PSE bit in CR4 (bit 4). Setting CR4.PSE to 1 allows operating-system software to use 4-Mbyte physical pages in the translation process. The 4-Mbyte physical pages can be mixed with standard 4-Kbyte physical pages or replace them entirely. The selection of physical-page size is made on a page-directory-entry basis. See “Page Size (PS) Bit” on page 139 for more information on physical-page size selection. When CR4.PSE is cleared to 0, page-size extensions are disabled.

The choice of 2 Mbyte or 4 Mbyte as the large physical-page size depends on the value of CR4.PSE and CR4.PAE, as follows:

- If physical-address extensions are enabled (CR4.PAE=1), the large physical-page size is 2 Mbytes, regardless of the value of CR4.PSE.
- If physical-address extensions are disabled (CR4.PAE=0) *and* CR4.PSE=1, the large physical-page size is 4 Mbytes.
- If both CR4.PAE=0 and CR4.PSE=0, the only available page size is 4 Kbytes.

The value of CR4.PSE is ignored when long mode is active. This is because physical-address extensions must be enabled in long mode, and the only available page sizes are 4 Kbytes and 2 Mbytes.

In legacy mode, physical addresses up to 40 bits long can be translated from 32-bit virtual addresses using 32-bit paging data-structure entries when 4-Mbyte physical-page sizes are selected. In this special case, CR4.PSE=1 and CR4.PAE=0. See “4-Mbyte Page Translation” on page 125 for a description of the 4-Mbyte PDE that supports 40-bit physical-address translation. The 40-bit physical-address capability is an AMD64 architecture enhancement over the similar capability available in the legacy x86 architecture.

### 5.1.5 Page-Directory Page Size (PS) Bit

The page directory offset entry (PDE) and page directory pointer offset entry (PDPE) are data structures used in page translation (see Figure 5-1 on page 119). The page-size (PS) bit in the PDE (bit 7, referred to as PDE.PS) selects between standard 4-Kbyte physical-page sizes and larger (2-Mbyte or 4-Mbyte) physical-page sizes. The page-size (also PS) bit in the PDPE (bit 7, referred to as PDPE.PS) selects between 2-Mbyte and 1-Gbyte physical-page sizes in long mode.

When PDE.PS is set to 1, large physical pages are used, and the PDE becomes the lowest level of the translation hierarchy. The size of the large page is determined by the values of CR4.PAE and CR4.PSE, as shown in Figure 5-1 on page 120. When PDE.PS is cleared to 0, standard 4-Kbyte physical pages are used, and the PTE is the lowest level of the translation hierarchy.

When PDPE.PS is set to 1, 1-Gbyte physical pages are used, and the PDPE becomes the lowest level of the translation hierarchy. Neither the PDE nor PTE are used for 1-Gbyte paging.

## 5.2 Legacy-Mode Page Translation

Legacy mode supports two forms of translation:

- *Normal (non-PAE) Paging*—This is used when physical-address extensions are disabled (CR4.PAE=0). Entries in the page translation table are 32 bits and are used to translate 32-bit virtual addresses into physical addresses as large as 40 bits.
- *PAE Paging*—This is used when physical-address extensions are enabled (CR4.PAE=1). Entries in the page translation table are 64 bits and are used to translate 32-bit virtual addresses into physical addresses as large as 52 bits.

Legacy paging uses up to three levels of page-translation tables, depending on the paging form used and the physical-page size. Entries within each table are selected using virtual-address bit fields. The legacy page-translation tables are:

- *Page Table*—Each page-table entry (PTE) points to a physical page. If 4-Kbyte pages are used, the page table is the lowest level of the page-translation hierarchy. PTEs are not used when translating 2-Mbyte or 4-Mbyte pages.
- *Page Directory*—If 4-Kbyte pages are used, each page-directory entry (PDE) points to a page table. If 2-Mbyte or 4-Mbyte pages are used, a PDE is the lowest level of the page-translation hierarchy and points to a physical page. In non-PAE paging, the page directory is the highest level of the translation hierarchy.
- *Page-Directory Pointer*—Each page-directory pointer entry (PDPE) points to a page directory. Page-directory pointers are only used in PAE paging (CR4.PAE=1), and are the highest level in the legacy page-translation hierarchy.

The translation-table-entry formats and how they are used in the various forms of legacy page translation are described beginning on page 124.

## 5.2.1 CR3 Register

The CR3 register is used to point to the base address of the highest-level page-translation table. The base address is either the page-directory pointer table or the page directory table. The CR3 register format depends on the form of paging being used. Figure 5-2 on page 123 shows the CR3 format when normal (non-PAE) paging is used ( $CR4.PAE=0$ ). Figure 5-3 shows the CR3 format when PAE paging is used ( $CR4.PAE=1$ ).

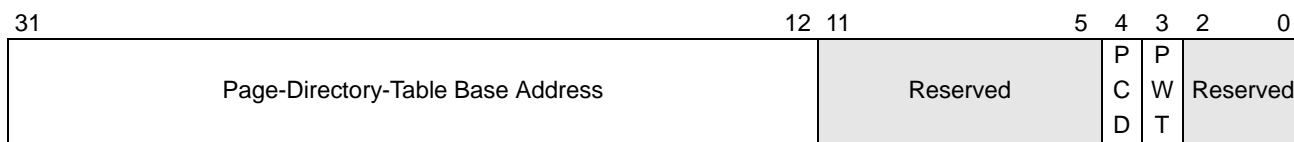

**Figure 5-2. Control Register 3 (CR3)—Non-PAE Paging Legacy-Mode**

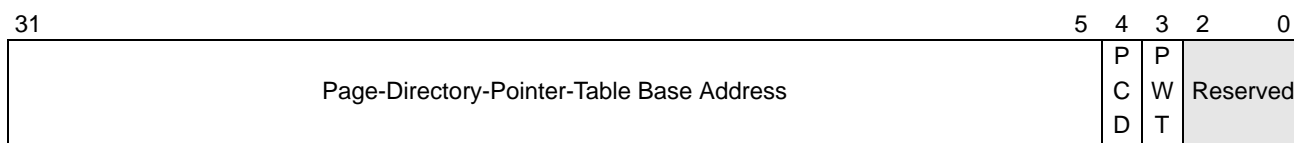

**Figure 5-3. Control Register 3 (CR3)—PAE Paging Legacy-Mode**

The CR3 register fields for legacy-mode paging are:

**Table Base Address Field.** This field points to the starting physical address of the highest-level page-translation table. The size of this field depends on the form of paging used:

- *Normal (Non-PAE) Paging ( $CR4.PAE=0$ )*—This 20-bit field occupies bits 31:12, and points to the base address of the page-directory table. The page-directory table is aligned on a 4-Kbyte boundary, with the low-order 12 address bits 11:0 assumed to be 0. This yields a total base-address size of 32 bits.
- *PAE Paging ( $CR4.PAE=1$ )*—This field is 27 bits and occupies bits 31:5. The CR3 register points to the base address of the page-directory-pointer table. The page-directory-pointer table is aligned on a 32-byte boundary, with the low 5 address bits 4:0 assumed to be 0.

**Page-Level Writethrough (PWT) Bit.** Bit 3. Page-level writethrough indicates whether the highest-level page-translation table has a writeback or writethrough caching policy. When  $PWT=0$ , the table has a writeback caching policy. When  $PWT=1$ , the table has a writethrough caching policy.

**Page-Level Cache Disable (PCD) Bit.** Bit 4. Page-level cache disable indicates whether the highest-level page-translation table is cacheable. When  $PCD=0$ , the table is cacheable. When  $PCD=1$ , the table is not cacheable.

**Reserved Bits.** Reserved fields should be cleared to 0 by software when writing CR3.

## 5.2.2 Normal (Non-PAE) Paging

Non-PAE paging (CR4.PAE=0) supports 4-Kbyte and 4-Mbyte physical pages, as described in the following sections.

**4-Kbyte Page Translation.** 4-Kbyte physical-page translation is performed by dividing the 32-bit virtual address into three fields. Each of the upper two fields is used as an index into a two-level page-translation hierarchy. The virtual-address fields are used as follows, and are shown in Figure 5-4:

- Bits 31:22 index into the 1024-entry page-directory table.
- Bits 21:12 index into the 1024-entry page table.
- Bits 11:0 provide the byte offset into the physical page.

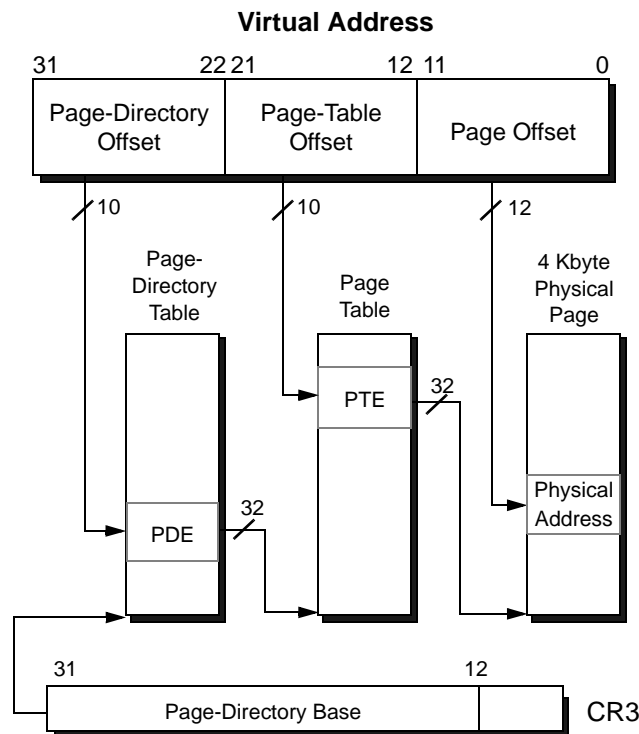

**Figure 5-4. 4-Kbyte Non-PAE Page Translation—Legacy Mode**

Figure 5-5 on page 125 shows the format of the PDE (page-directory entry), and Figure 5-6 on page 125 shows the format of the PTE (page-table entry). Each table occupies 4 Kbytes and can hold 1024 of the 32-bit table entries. The fields within these table entries are described in “Page-Translation-Table Entry Fields” on page 137.

Figure 5-5 shows bit 7 cleared to 0. This bit is the *page-size* bit (PS), and specifies a 4-Kbyte physical-page translation.



**Figure 5-5. 4-Kbyte PDE—Non-PAE Paging Legacy-Mode**



**Figure 5-6. 4-Kbyte PTE—Non-PAE Paging Legacy-Mode**

**4-Mbyte Page Translation.** 4-Mbyte page translation is only supported when page-size extensions are enabled (CR4.PSE=1) and physical-address extensions are disabled (CR4.PAE=0).

PSE defines a page-size bit in the 32-bit PDE format (PDE.PS). This bit is used by the processor during page translation to support both 4-Mbyte and 4-Kbyte pages. 4-Mbyte pages are selected when PDE.PS is set to 1, and the PDE points directly to a 4-Mbyte physical page. PTEs are not used in a 4-Mbyte page translation. If PDE.PS is cleared to 0, or if 4-Mbyte page translation is disabled, the PDE points to a PTE.

4-Mbyte page translation is performed by dividing the 32-bit virtual address into two fields. Each field is used as an index into a single-level page-translation hierarchy. The virtual-address fields are used as follows, and are shown in Figure 5-7 on page 126:

- Bits 31:22 index into the 1024-entry page-directory table.
- Bits 21:0 provide the byte offset into the physical page.



addresses (up to 52 bits). The size of each table remains 4 Kbytes, which means each table can hold 512 of the 64-bit entries. PAE paging also introduces a third-level page-translation table, known as the page-directory-pointer table (PDP).

The size of large pages in PAE-paging mode is 2 Mbytes rather than 4 Mbytes. PAE uses the page-directory page-size bit (PDE.PS) to allow selection between 4-Kbyte and 2-Mbyte page sizes. PAE automatically uses the page-size bit, so the value of CR4.PSE is ignored by PAE paging.

**4-Kbyte Page Translation.** With PAE paging, 4-Kbyte physical-page translation is performed by dividing the 32-bit virtual address into four fields, each of the upper three fields is used as an index into a 3-level page-translation hierarchy. The virtual-address fields are described as follows and are shown in Figure 5-9:

- Bits 31:30 index into a 4-entry page-directory-pointer table.
- Bits 29:21 index into the 512-entry page-directory table.
- Bits 20:12 index into the 512-entry page table.
- Bits 11:0 provide the byte offset into the physical page.

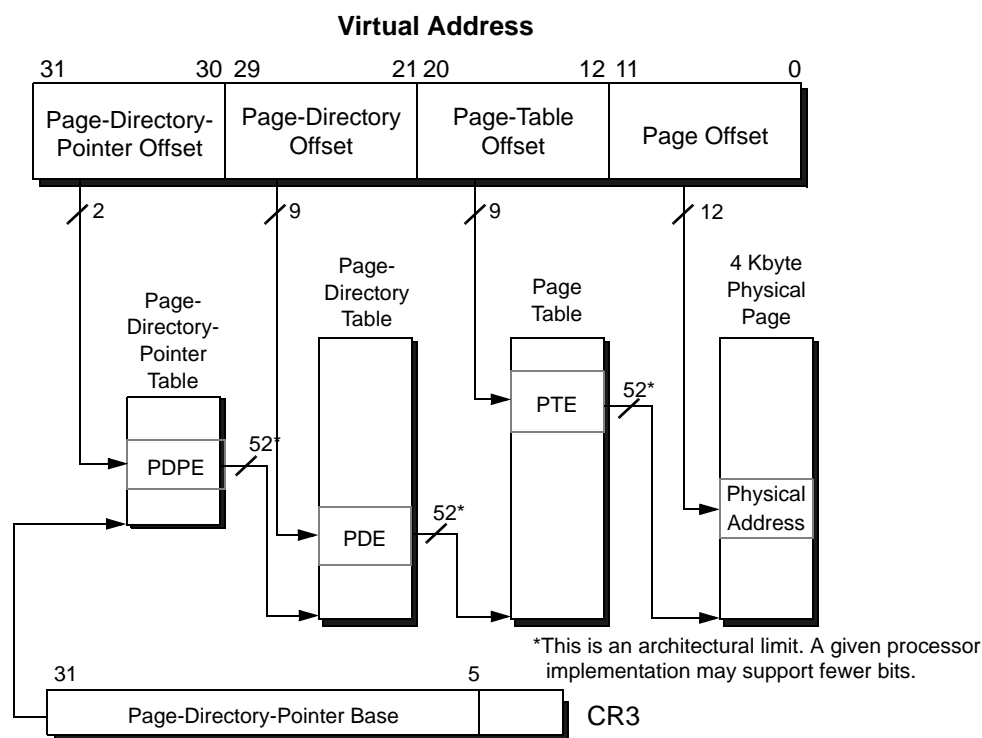

**Figure 5-9. 4-Kbyte PAE Page Translation—Legacy Mode**

Figures 5-10 through 5-12 show the legacy-mode 4-Kbyte translation-table formats:

- Figure 5-10 shows the PDPE (page-directory-pointer entry) format.
- Figure 5-11 shows the PDE (page-directory entry) format.
- Figure 5-12 shows the PTE (page-table entry) format.

The fields within these table entries are described in “Page-Translation-Table Entry Fields” on page 137.

Figure 5-11 shows the PDE.PS bit cleared to 0 (bit 7), specifying a 4-Kbyte physical-page translation.

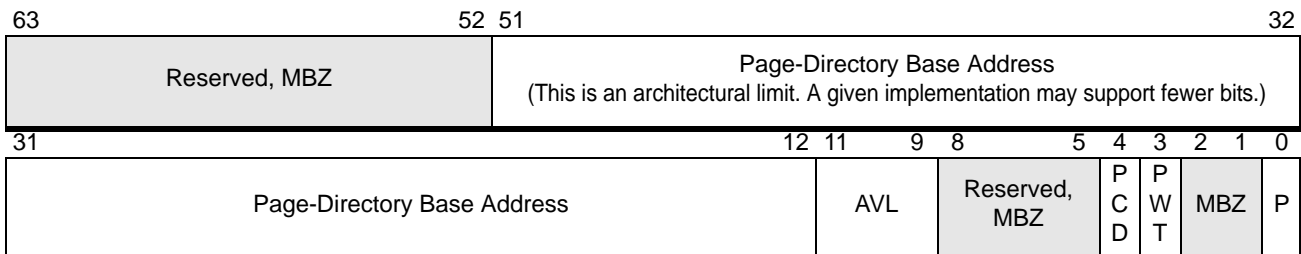

Figure 5-10. 4-Kbyte PDPE—PAE Paging Legacy-Mode

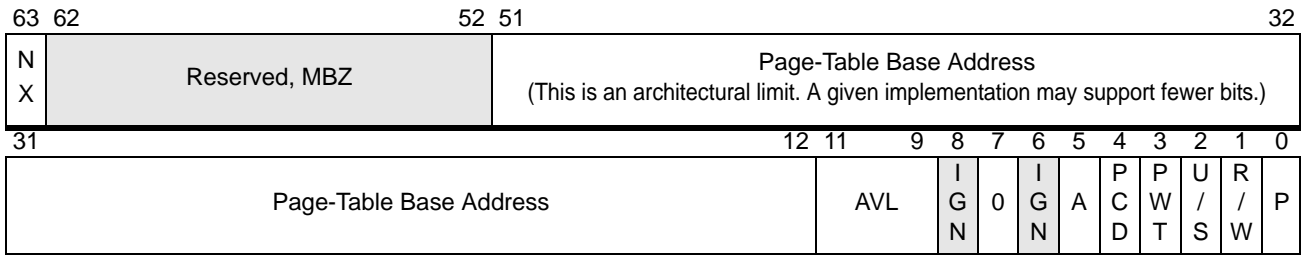

Figure 5-11. 4-Kbyte PDE—PAE Paging Legacy-Mode

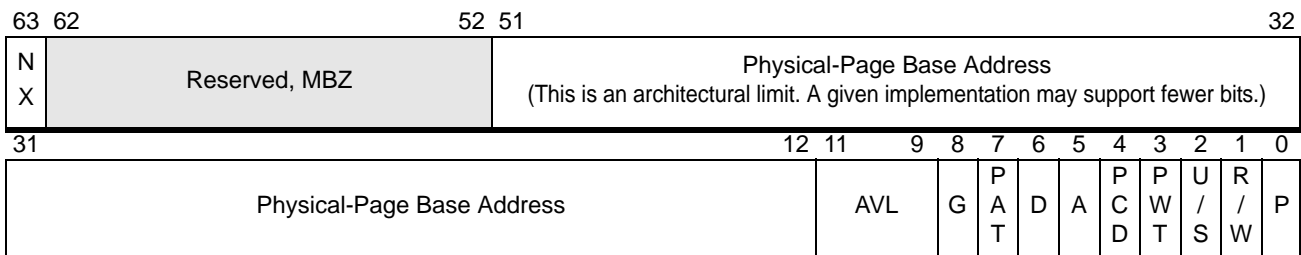

Figure 5-12. 4-Kbyte PTE—PAE Paging Legacy-Mode

**2-Mbyte Page Translation.** 2-Mbyte page translation is performed by dividing the 32-bit virtual address into three fields. Each field is used as an index into a 2-level page-translation hierarchy. The virtual-address fields are described as follows and are shown in Figure 5-13 on page 129:

- Bits 31:30 index into the 4-entry page-directory-pointer table.



- Bits 29:21 index into the 512-entry page-directory table.
- Bits 20:0 provide the byte offset into the physical page.

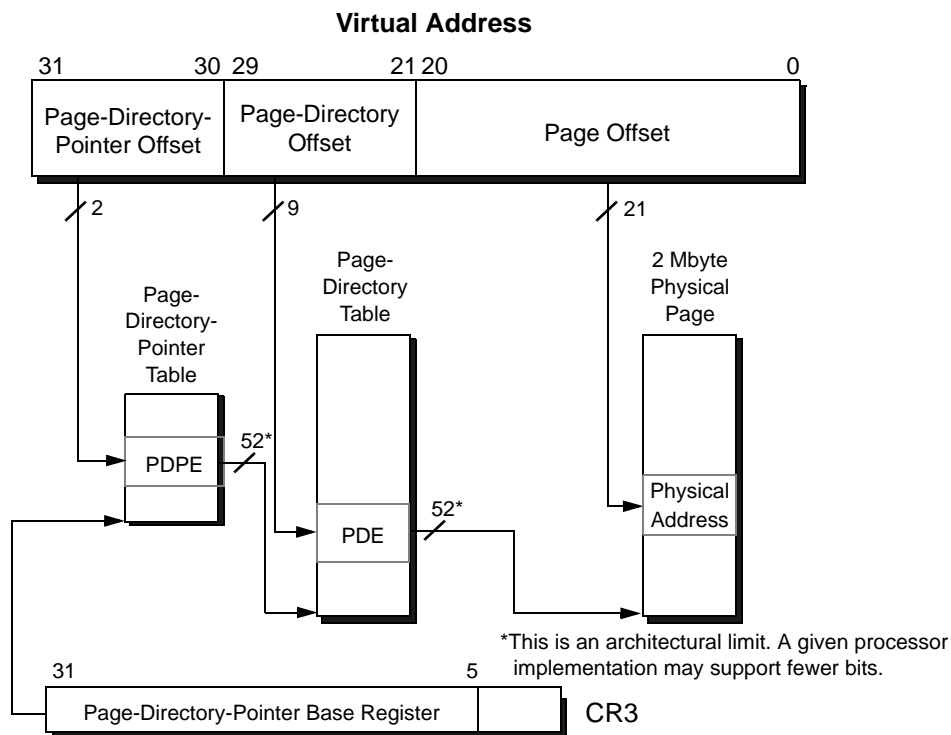

**Figure 5-13. 2-Mbyte PAE Page Translation—Legacy Mode**

Figure 5-14 shows the format of the PDPE (page-directory-pointer entry) and Figure 5-15 on page 130 shows the format of the PDE (page-directory entry). PTEs are not used in 2-Mbyte page translations.

Figure 5-15 on page 130 shows the PDE.PS bit set to 1 (bit 7), specifying a 2-Mbyte physical-page translation.

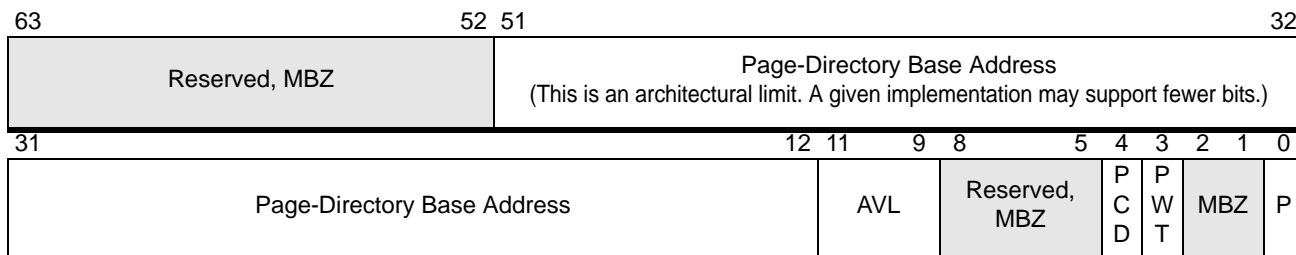

**Figure 5-14. 2-Mbyte PDPE—PAE Paging Legacy-Mode**

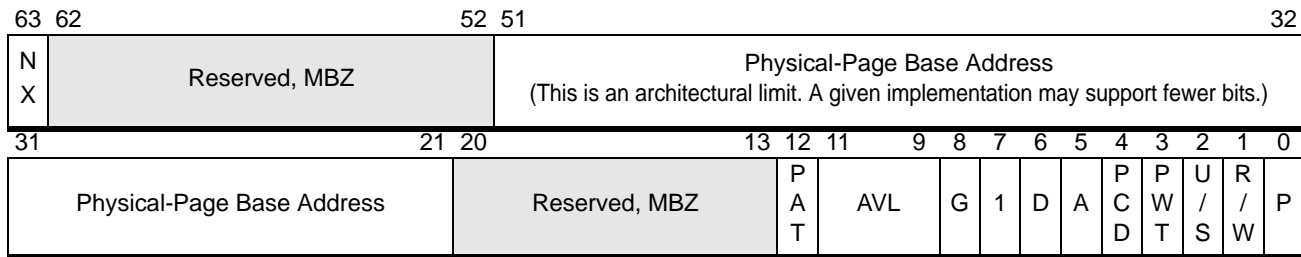

**Figure 5-15. 2-Mbyte PDE—PAE Paging Legacy-Mode**

## 5.3 Long-Mode Page Translation

Long-mode page translation requires the use of physical-address extensions (PAE). Before activating long mode, PAE must be enabled by setting CR4.PAE to 1. Activating long mode before enabling PAE causes a general-protection exception (#GP) to occur.

The PAE-paging data structures support mapping of 64-bit virtual addresses into 52-bit physical addresses. PAE expands the size of legacy page-directory entries (PDEs) and page-table entries (PTEs) from 32 bits to 64 bits, allowing physical-address sizes of greater than 32 bits.

The AMD64 architecture enhances the page-directory-pointer entry (PDPE) by defining previously reserved bits for access and protection control. A new translation table is added to PAE paging, called the page-map level-4 (PML4). The PML4 table precedes the PDP table in the page-translation hierarchy.

Because PAE is always enabled in long mode, the PS bit in the page directory entry (PDE.PS) selects between 4-Kbyte and 2-Mbyte page sizes, and the CR4.PSE bit is ignored. When 1-Gbyte pages are supported, the PDPE.PS bit selects the 1-Gbyte page size.

### 5.3.1 Canonical Address Form

The AMD64 architecture requires implementations supporting fewer than the full 64-bit virtual address to ensure that those addresses are in canonical form. An address is in canonical form if the address bits from the most-significant implemented bit up to bit 63 are all ones or all zeros. If the addresses of all bytes in a virtual-memory reference are not in canonical form, the processor generates a general-protection exception (#GP) or a stack fault (#SS) as appropriate.

### 5.3.2 CR3

In long mode, the CR3 register is used to point to the PML4 base address. CR3 is expanded to 64 bits in long mode, allowing the PML4 table to be located anywhere in the 52-bit physical-address space. Figure 5-16 on page 131 shows the long-mode CR3 format.

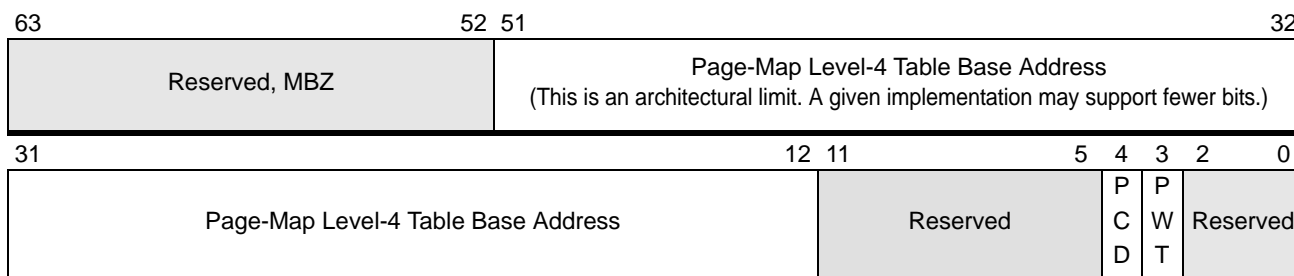

**Figure 5-16. Control Register 3 (CR3)—Long Mode**

The CR3 register fields for long mode are:

**Table Base Address Field.** Bits 51:12. This 40-bit field points to the PML4 base address. The PML4 table is aligned on a 4-Kbyte boundary with the low-order 12 address bits (11:0) assumed to be 0. This yields a total base-address size of 52 bits. System software running on processor implementations supporting less than the full 52-bit physical-address space must clear the unimplemented upper base-address bits to 0.

**Page-Level Writethrough (PWT) Bit.** Bit 3. Page-level writethrough indicates whether the highest-level page-translation table has a writeback or writethrough caching policy. When PWT=0, the table has a writeback caching policy. When PWT=1, the table has a writethrough caching policy.

**Page-Level Cache Disable (PCD) Bit.** Bit 4. Page-level cache disable indicates whether the highest-level page-translation table is cacheable. When PCD=0, the table is cacheable. When PCD=1, the table is not cacheable.

**Reserved Bits.** Reserved fields should be cleared to 0 by software when writing CR3.

### 5.3.3 4-Kbyte Page Translation

In long mode, 4-Kbyte physical-page translation is performed by dividing the virtual address into six fields. Four of the fields are used as indices into the level page-translation hierarchy. The virtual-address fields are described as follows, and are shown in Figure 5-17 on page 132:

- Bits 63:48 are a sign extension of bit 47, as required for canonical-address forms.
- Bits 47:39 index into the 512-entry page-map level-4 table.
- Bits 38:30 index into the 512-entry page-directory pointer table.
- Bits 29:21 index into the 512-entry page-directory table.
- Bits 20:12 index into the 512-entry page table.
- Bits 11:0 provide the byte offset into the physical page.

**Note:** *The sizes of the sign extension and the PML4 fields depend on the number of virtual address bits supported by the implementation.*

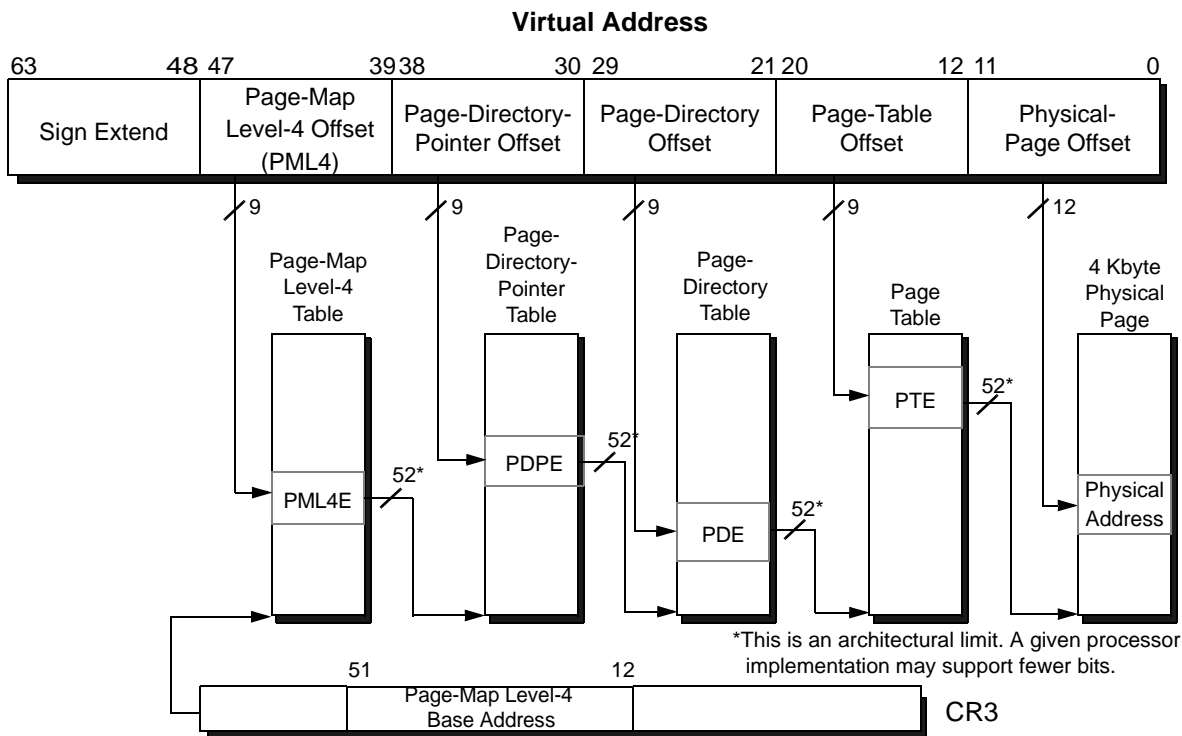

**Figure 5-17. 4-Kbyte Page Translation—Long Mode**

Figures 5-18 through 5-20 on page 133 and Figure 5-21 on page 133 show the long-mode 4-Kbyte translation-table formats:

- Figure 5-18 on page 133 shows the PML4E (page-map level-4 entry) format.
- Figure 5-19 on page 133 shows the PDPE (page-directory-pointer entry) format.
- Figure 5-20 on page 133 shows the PDE (page-directory entry) format.
- Figure 5-21 on page 133 shows the PTE (page-table entry) format.

The fields within these table entries are described in “Page-Translation-Table Entry Fields” on page 137.

Figure 5-20 on page 133 shows the PDE.PS bit (bit 7) cleared to 0, indicating a 4-Kbyte physical-page translation.

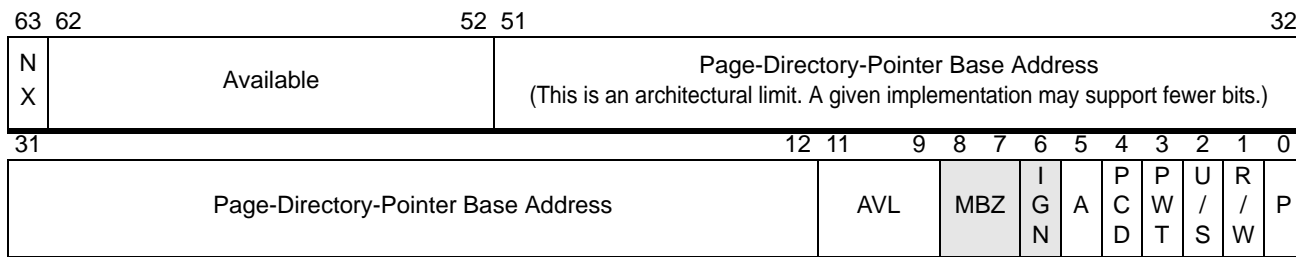

**Figure 5-18. 4-Kbyte PML4E—Long Mode**

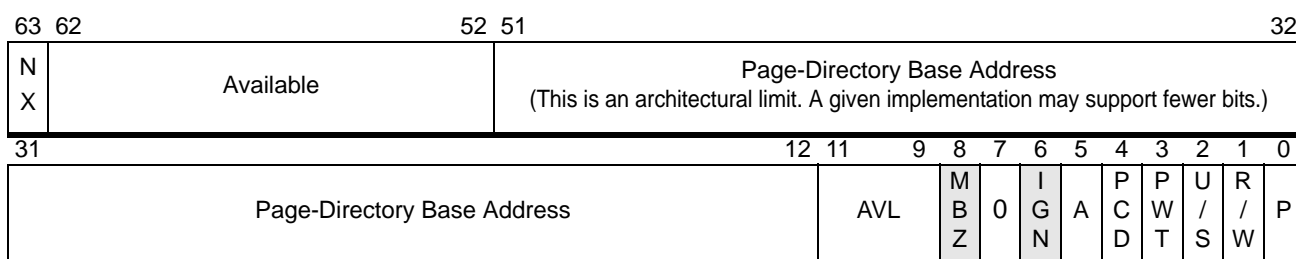

**Figure 5-19. 4-Kbyte PDPE—Long Mode**

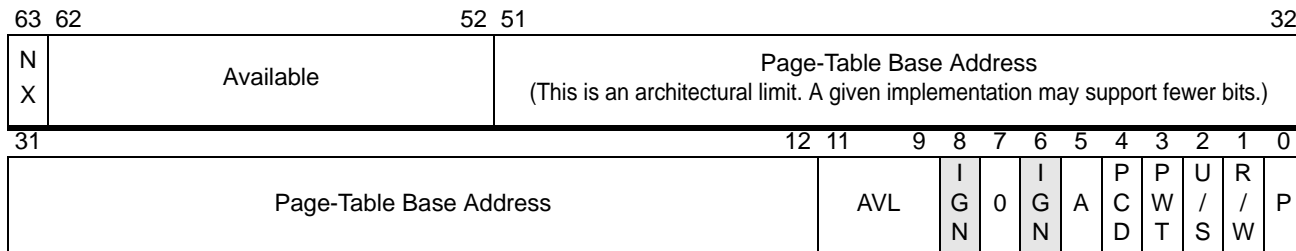

**Figure 5-20. 4-Kbyte PDE—Long Mode**

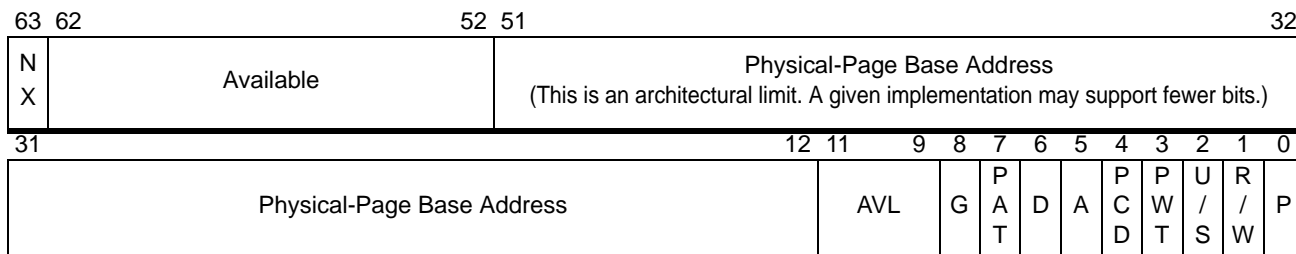
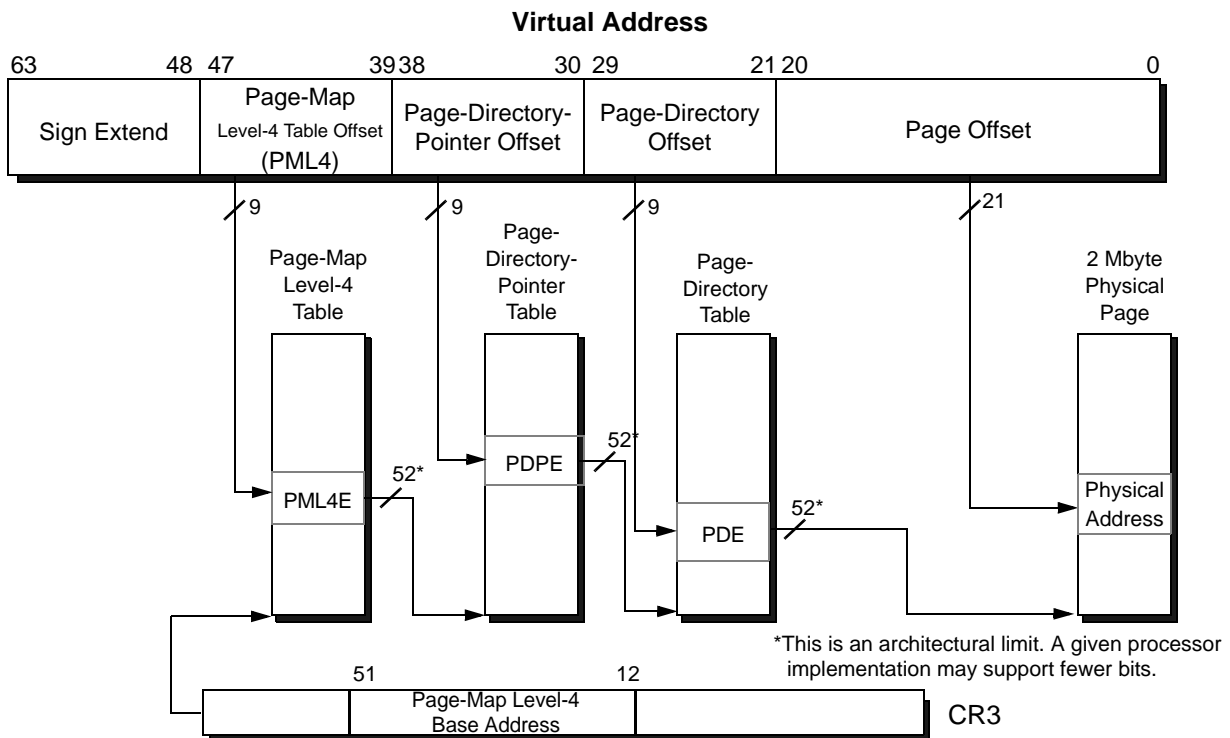

**Figure 5-21. 4-Kbyte PTE—Long Mode**

### 5.3.4 2-Mbyte Page Translation

In long mode, 2-Mbyte physical-page translation is performed by dividing the virtual address into five fields. Three of the fields are used as indices into the level page-translation hierarchy. The virtual-address fields are described as follows, and are shown in Figure 5-22:

- Bits 63:48 are a sign extension of bit 47 as required for canonical address forms.
- Bits 47:39 index into the 512-entry page-map level-4 table.
- Bits 38:30 index into the 512-entry page-directory-pointer table.
- Bits 29:21 index into the 512-entry page-directory table.
- Bits 20:0 provide the byte offset into the physical page.

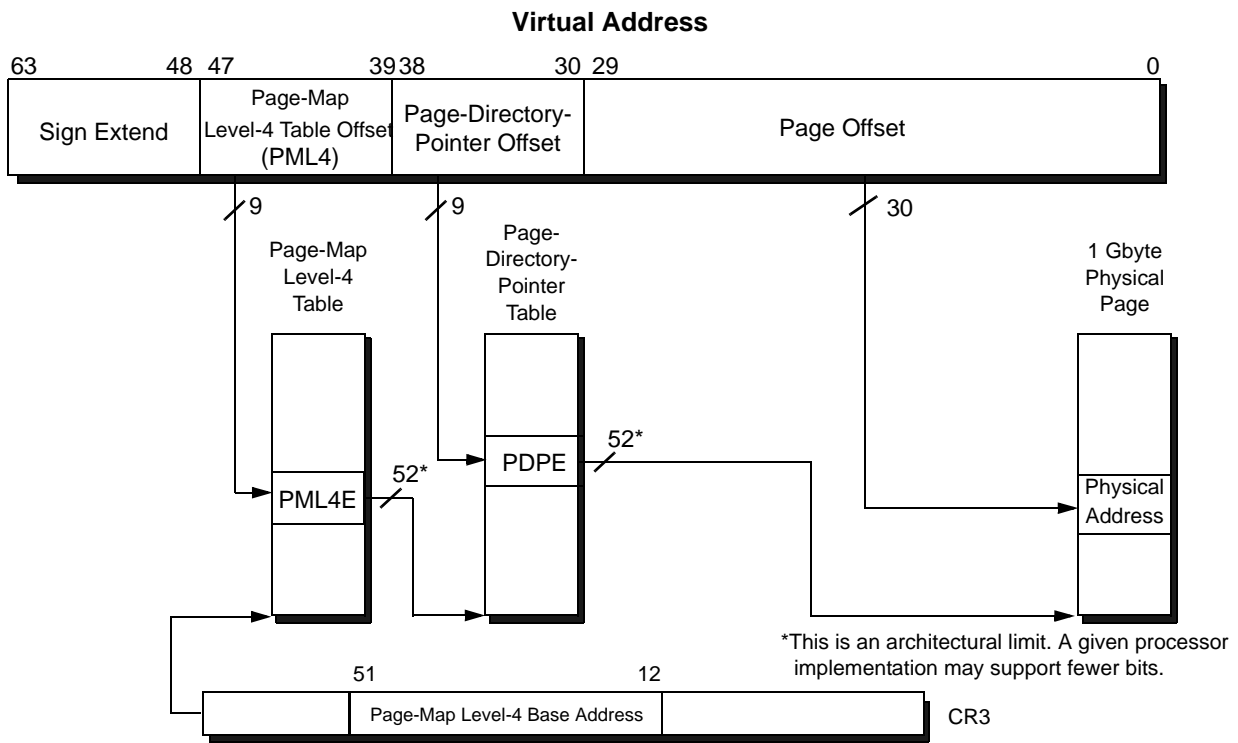

**Figure 5-22. 2-Mbyte Page Translation—Long Mode**

Figures 5-23 through 5-25 on page 135 show the long-mode 2-Mbyte translation-table formats (the PML4 and PDPT formats are identical to those used for 4-Kbyte page translations and are repeated here for clarity):

- Figure 5-23 on page 135 shows the PML4E (page-map level-4 entry) format.
- Figure 5-24 on page 135 shows the PDPE (page-directory-pointer entry) format.
- Figure 5-25 on page 135 shows the PDE (page-directory entry) format.





**Figure 5-26. 1-Gbyte Page Translation—Long Mode**

Figure 5-27 and Figure 5-28 on page 137 show the long mode 1-Gbyte translation-table formats (the PML4 format is identical to the one used for 4-Kbyte page translations and is repeated here for clarity):

- Figure 5-27 shows the PML4E (page-map level-4 entry) format.
- Figure 5-28 shows the PDPE (page-directory-pointer entry) format.

The fields within these table entries are described in “Page-Translation-Table Entry Fields” on page 137 in the current volume. PTEs and PDEs are not used in 1-Gbyte page translations.

Figure 5-28 on page 137 shows the PDPE.PS bit (bit 7) set to 1, indicating a 1-Gbyte physical-page translation.



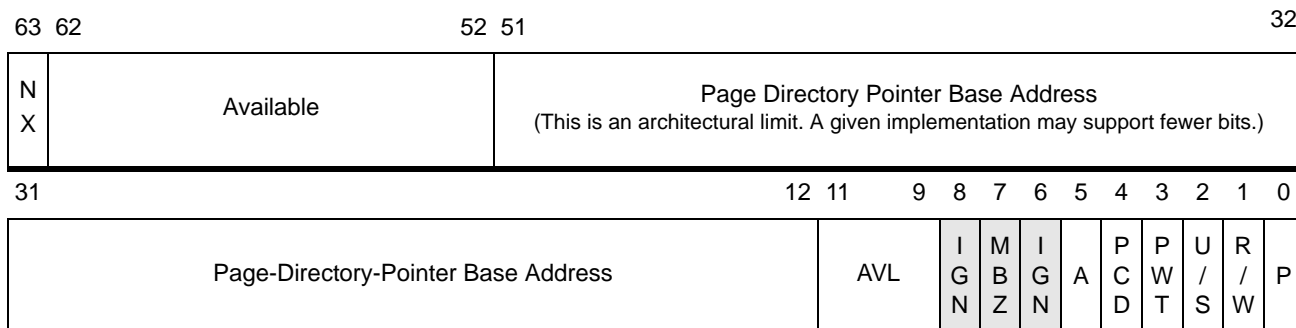

Figure 5-27. 1-Gbyte PML4E—Long Mode

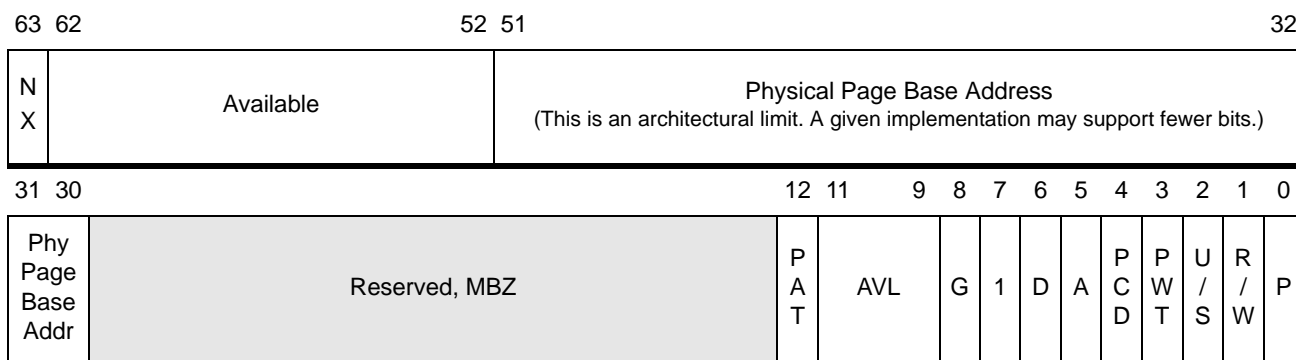

Figure 5-28. 1-Gbyte PDPE—Long Mode

**1-Gbyte Paging Feature Identification.** EDX bit 26 as returned by CPUID function 8000\_0001h indicates 1-Gbyte page support. The EAX register as returned by CPUID function 8000\_0019h reports the number of 1-Gbyte L1 TLB entries supported and EBX reports the number of 1-Gbyte L2 TLB entries. For more information using the CPUID instruction see Section 3.3 “Processor Feature Identification” on page 63.

## 5.4 Page-Translation-Table Entry Fields

The page-translation-table entries contain control and informational fields used in the management of the virtual-memory environment. Most fields are common across all translation table entries and modes and occupy the same bit locations. However, some fields are located in different bit positions depending on the page translation hierarchical level, and other fields have different sizes depending on which physical-page size, physical-address size, and operating mode are selected. Although these fields can differ in bit position or size, their meaning is consistent across all levels of the page translation hierarchy and in all operating modes.

### 5.4.1 Field Definitions

The following sections describe each field within the page-translation table entries.

**Translation-Table Base Address Field.** The translation-table base-address field points to the physical base address of the next-lower-level table in the page-translation hierarchy. Page data-structure tables are always aligned on 4-Kbyte boundaries, so only the address bits above bit 11 are stored in the translation-table base-address field. Bits 11:0 are assumed to be 0. The size of the field depends on the mode:

- In normal (non-PAE) paging (CR4.PAE=0), this field specifies a 32-bit physical address.
- In PAE paging (CR4.PAE=1), this field specifies a 52-bit physical address.

52 bits correspond to the maximum physical-address size allowed by the AMD64 architecture. If a processor implementation supports fewer than the full 52-bit physical address, software must clear the unimplemented high-order translation-table base-address bits to 0. For example, if a processor implementation supports a 40-bit physical-address size, software must clear bits 51:40 when writing a translation-table base-address field in a page data-structure entry.

**Physical-Page Base Address Field.** The physical-page base-address field points to the base address of the translated physical page. This field is found only in the lowest level of the page-translation hierarchy. The size of the field depends on the mode:

- In normal (non-PAE) paging (CR4.PAE=0), this field specifies a 32-bit base address for a physical page.
- In PAE paging (CR4.PAE=1), this field specifies a 52-bit base address for a physical page.

Physical pages can be 4 Kbytes, 2 Mbytes, 4 Mbytes, or 1-Gbyte and they are always aligned on an address boundary corresponding to the physical-page length. For example, a 2-Mbyte physical page is always aligned on a 2-Mbyte address boundary. Because of this alignment, the low-order address bits are assumed to be 0, as follows:

- 4-Kbyte pages, bits 11:0 are assumed 0.
- 2-Mbyte pages, bits 20:0 are assumed 0.
- 4-Mbyte pages, bits 21:0 are assumed 0.
- 1-Gbyte pages, bits 29:0 are assumed 0.

**Present (P) Bit.** Bit 0. This bit indicates whether the page-translation table or physical page is loaded in physical memory. When the P bit is cleared to 0, the table or physical page is not loaded in physical memory. When the P bit is set to 1, the table or physical page is loaded in physical memory.

Software clears this bit to 0 to indicate a page table or physical page is not loaded in physical memory. A page-fault exception (#PF) occurs if an attempt is made to access a table or page when the P bit is 0. System software is responsible for loading the missing table or page into memory and setting the P bit to 1.

When the P bit is 0, indicating a not-present page, all remaining bits in the page data-structure entry are available to software.

Entries with P cleared to 0 are never cached in TLB nor will the processor set the Accessed or Dirty bit for the table entry.

**Read/Write (R/W) Bit.** Bit 1. This bit controls read/write access to all physical pages mapped by the table entry. For example, a page-map level-4 R/W bit controls read/write access to all 128M ( $512 \times 512 \times 512$ ) physical pages it maps through the lower-level translation tables. When the R/W bit is cleared to 0, access is restricted to read-only. When the R/W bit is set to 1, both read and write access is allowed. See “Page-Protection Checks” on page 145 for a description of the paging read/write protection mechanism.

**User/Supervisor (U/S) Bit.** Bit 2. This bit controls user (CPL 3) access to all physical pages mapped by the table entry. For example, a page-map level-4 U/S bit controls the access allowed to all 128M ( $512 \times 512 \times 512$ ) physical pages it maps through the lower-level translation tables. When the U/S bit is cleared to 0, access is restricted to supervisor level (CPL 0, 1, 2). When the U/S bit is set to 1, both user and supervisor access is allowed. See “Page-Protection Checks” on page 145 for a description of the paging user/supervisor protection mechanism.

**Page-Level Writethrough (PWT) Bit.** Bit 3. This bit indicates whether the page-translation table or physical page to which this entry points has a writeback or writethrough caching policy. When the PWT bit is cleared to 0, the table or physical page has a writeback caching policy. When the PWT bit is set to 1, the table or physical page has a writethrough caching policy. See “Memory Caches” on page 179 for additional information on caching.

**Page-Level Cache Disable (PCD) Bit.** Bit 4. This bit indicates whether the page-translation table or physical page to which this entry points is cacheable. When the PCD bit is cleared to 0, the table or physical page is cacheable. When the PCD bit is set to 1, the table or physical page is not cacheable. See “Memory Caches” on page 179 for additional information on caching.

**Accessed (A) Bit.** Bit 5. This bit indicates whether the page-translation table or physical page to which this entry points has been accessed. The A bit is set to 1 by the processor the first time the table or physical page is either read from or written to. The A bit is never cleared by the processor. Instead, software must clear this bit to 0 when it needs to track the frequency of table or physical-page accesses.

**Dirty (D) Bit.** Bit 6. This bit is only present in the lowest level of the page-translation hierarchy. It indicates whether the physical page to which this entry points has been written. The D bit is set to 1 by the processor the first time there is a write to the physical page. The D bit is never cleared by the processor. Instead, software must clear this bit to 0 when it needs to track the frequency of physical-page writes.

**Page Size (PS) Bit.** Bit 7. This bit is present in page-directory entries and long-mode page-directory-pointer entries. When the PS bit is set in the page-directory-pointer entry (PDPE) or page-directory entry (PDE), that entry is the lowest level of the page-translation hierarchy. When the PS bit is cleared

to 0 in all levels, the lowest level of the page-translation hierarchy is the page-table entry (PTE), and the physical-page size is 4 Kbytes. The physical-page size is determined as follows:

- If `EFER.LMA=1` and `PDPE.PS=1`, the physical-page size is 1 Gbyte.
- If `CR4.PAE=0` and `PDE.PS=1`, the physical-page size is 4 Mbytes.
- If `CR4.PAE=1` and `PDE.PS=1`, the physical-page size is 2 Mbytes.

See Table 5-1 on page 120 for a description of the relationship between the PS bit, PAE, physical-page sizes, and page-translation hierarchy.

**Global Page (G) Bit.** Bit 8. This bit is only present in the lowest level of the page-translation hierarchy. It indicates the physical page is a global page. The TLB entry for a global page (`G=1`) is not invalidated when `CR3` is loaded either explicitly by a `MOV CRn` instruction or implicitly during a task switch. Use of the G bit requires the page-global enable bit in `CR4` to be set to 1 (`CR4.PGE=1`). See “Global Pages” on page 142 for more information on the global-page mechanism.

**Available to Software (AVL) Bit.** These bits are not interpreted by the processor and are available for use by system software.

**Page-Attribute Table (PAT) Bit.** This bit is only present in the lowest level of the page-translation hierarchy, as follows:

- If the lowest level is a PTE (`PDE.PS=0`), PAT occupies bit 7.
- If the lowest level is a PDE (`PDE.PS=1`) or PDPE (`PDPE.PS=1`), PAT occupies bit 12.

The PAT bit is the high-order bit of a 3-bit index into the PAT register (Figure 7-10 on page 199). The other two bits involved in forming the index are the PCD and PWT bits. Not all processors support the PAT bit by implementing the PAT registers. See “Page-Attribute Table Mechanism” on page 199 for a description of the PAT mechanism and how it is used.

**No Execute (NX) Bit.** Bit 63. This bit is present in the translation-table entries defined for PAE paging, with the exception that the legacy-mode PDPE does not contain this bit. This bit is not supported by non-PAE paging.

The NX bit can only be set when the no-execute page-protection feature is enabled by setting `EFER.NXE` to 1 (see “Extended Feature Enable Register (EFER)” on page 55). If `EFER.NXE=0`, the NX bit is treated as reserved. In this case, a page-fault exception (`#PF`) occurs if the NX bit is not cleared to 0.

This bit controls the ability to execute code from all physical pages mapped by the table entry. For example, a page-map level-4 NX bit controls the ability to execute code from all 128M ( $512 \times 512 \times 512$ ) physical pages it maps through the lower-level translation tables. When the NX bit is cleared to 0, code can be executed from the mapped physical pages. When the NX bit is set to 1, code cannot be executed from the mapped physical pages. See “No Execute (NX) Bit” on page 140 for a description of the no-execute page-protection mechanism.

**Reserved Bits.** Software should clear all reserved bits to 0. If the processor is in long mode, or if page-size and physical-address extensions are enabled in legacy mode, a page-fault exception (#PF) occurs if reserved bits are not cleared to 0.

### 5.4.2 Notes on Access and Dirty Bits

The processor never sets the Accessed bit or the Dirty bit for a not present page ( $P = 0$ ). The ordering of Accessed and Dirty bit updates with respect to surrounding loads and stores is discussed below.

**Accessed (A) Bit.** The Accessed bit can be set for instructions that are speculatively executed by the processor.

For example, the Accessed bit may be set by instructions in a mispredicted branch path even though those instructions are never retired. Thus, software must not assume that the TLB entry has not been cached in the TLB, just because no instruction that accessed the page was successfully retired.

Nevertheless, a table entry is never cached in the TLB without its Accessed bit being set at the same time.

The processor does not order Accessed bit updates with respect to loads done by other instructions.

**Dirty (D) Bit.** The Dirty bit is not updated speculatively. For instructions with multiple writes, the D bit may be set for any writes completed up to the point of a fault. In rare cases, the Dirty bit may be set even if a write was not actually performed, including MASKMOVQ with a mask of zero and certain x87 floating point instructions that cause an exception. Thus software can not assume that the page has actually been written even where PTE[D] is set to 1.

If PTE[D] is cleared to 0, software can rely on the fact that the page has not been written.

In general, Dirty bit updates are ordered with respect to other loads and stores, although not necessarily with respect to accesses to WC memory; in particular, they may not cause WC buffers to be flushed. However, to ensure compatibility with future processors, a serializing operation should be inserted before reading the D bit.

## 5.5 Translation-Lookaside Buffer (TLB)

When paging is enabled, every memory access has its virtual address automatically translated into a physical address using the page-translation hierarchy. *Translation-lookaside buffers* (TLBs), also known as *page-translation caches*, nearly eliminate the performance penalty associated with page translation. TLBs are special on-chip caches that hold the most-recently used virtual-to-physical address translations. Each memory reference (instruction and data) is checked by the TLB. If the translation is present in the TLB, it is immediately provided to the processor, thus avoiding external memory references for accessing page tables.

TLBs take advantage of the *principle of locality*. That is, if a memory address is referenced, it is likely that nearby memory addresses will be referenced in the near future. In the context of paging, the proximity of memory addresses required for locality can be broad—it is equal to the page size. Thus, it

is possible for a large number of addresses to be translated by a small number of page translations. This high degree of locality means that almost all translations are performed using the on-chip TLBs.

System software is responsible for managing the TLBs when updates are made to the linear-to-physical mapping of addresses. A change to any paging data-structure entry is not automatically reflected in the TLB, and hardware snooping of TLBs during memory-reference cycles is not performed. Software must invalidate the TLB entry of a modified translation-table entry so that the change is reflected in subsequent address translations. TLB invalidation is described in “TLB Management” on page 142. Only privileged software running at CPL=0 can manage the TLBs.

### 5.5.1 Global Pages

The processor invalidates the TLB whenever CR3 is loaded either explicitly or implicitly. After the TLB is invalidated, subsequent address references can consume many clock cycles until their translations are cached as new entries in the TLB. Invalidation of TLB entries for frequently-used or critical pages can be avoided by specifying the translations for those pages as *global*. TLB entries for global pages are not invalidated as a result of a CR3 load. Global pages are invalidated using the INVLPG instruction.

Global-page extensions are controlled by setting and clearing the PGE bit in CR4 (bit 7). When CR4.PGE is set to 1, global-page extensions are enabled. When CR4.PGE is cleared to 0, global-page extensions are disabled. When CR4.PGE=1, setting the global (G) bit in the translation-table entry marks the page as global.

The INVLPG instruction ignores the G bit and can be used to invalidate individual global-page entries in the TLB. To invalidate all entries, including global-page entries, disable global-page extensions (CR4.PGE=0).

### 5.5.2 TLB Management

Generally, unless system software modifies the linear-to-physical address mapping, the processor manages the TLB transparently to software. This includes allocating entries and replacing old entries with new entries. In general, software changes made to paging-data structures are not automatically reflected in the TLB. In these situations, it is necessary for software to invalidate TLB entries so that these changes are immediately propagated to the page-translation mechanism.

TLB entries can be explicitly invalidated using operations intended for that purpose or implicitly invalidated as a result of another operation. TLB invalidation has no effect on the associated page-translation tables in memory.

**Explicit Invalidations.** Three mechanisms are provided to explicitly invalidate the TLB:

- The *invalidate TLB entry* instruction (INVLPG) can be used to invalidate specific entries within the TLB. This instruction invalidates a page, regardless of whether it is marked as global or not. The Invalidate TLB entry in a Specified ASID (INVLPGA) operates similarly, but operates on the specified ASID. See “Invalidate Page, Alternate ASID” on page 474.

- Updates to the CR3 register cause the entire TLB to be invalidated *except* for global pages. The CR3 register can be updated with the MOV CR3 instruction. CR3 is also updated during a task switch, with the updated CR3 value read from the TSS of the new task.
- The TLB\_CONTROL field of a VMCB can request specific flushes of the TLB to occur when the VMRUN instruction is executed on that VMCB. See “TLB Flush” on page 473.

**Implicit Invalidations.** The following operations cause the entire TLB to be invalidated, including global pages:

- Modifying the CR0.PG bit (paging enable).
- Modifying the CR4.PAE bit (physical-address extensions), the CR4.PSE bit (page-size extensions), or the CR4.PGE bit (page-global enable).
- Entering SMM as a result of an SMI interrupt.
- Executing the RSM instruction to return from SMM.
- Updating a memory-type range register (MTRR) with the WRMSR instruction.
- External initialization of the processor.
- External masking of the A20 address bit (asserting the A20M# input signal).
- Writes to certain model-specific registers with the WRMSR instruction; see the *BIOS and Kernel Developer's Guide* applicable to your product for more information

**Invalidation of Table Entry Upgrades.** If a table entry is updated to remove a permission violation, such as removing supervisor, read-only, and/or no-execute restrictions, an invalidation is not required, because the hardware will automatically detect the changes. If a table entry is updated and does not remove a permission violation, it is unpredictable whether the old or updated entry will be used until an invalidation is performed.

**Speculative Caching of Address Translations.** For performance reasons, AMD64 processors may speculatively load valid address translations into the TLB on false execution paths. Such translations are not based on references that a program makes from an “architectural state” perspective, but which the processor may make in speculatively following an instruction path which turns out to be mispredicted. In general, the processor may create a TLB entry for any linear address for which valid entries exist in the page table structure currently pointed to by CR3. This may occur for both instruction fetches and data references. Such entries remain cached in the TLBs and may be used in subsequent translations. Loading a translation speculatively will set the Accessed bit, if not already set. A translation will *not* be loaded speculatively if the Dirty bit needs to be set.

**Caching of Upper Level Translation Table Entries.** Similarly, to improve the performance of table walks on TLB misses, AMD64 processors may save upper level translation table entries in special table walk caching structures which are kept coherent with the tables in memory via the same mechanisms as the TLBs—by means of the INVLPG instruction, moves to CR3, and modification of paging control bits in CR0 and CR4. Like address translations in the TLB, these upper level entries may also be cached speculatively and by false-path execution. These entries are never cached if their P (present) bits are set to 0.

Under certain circumstances, an upper-level table entry that cannot ultimately lead to a valid translation (because there are no valid entries in the lower level table to which it points) may also be cached. This can happen while executing down a false path, when an in-progress table walk gets cancelled by the branch mispredict before the low level table entry that would cause a fault is encountered. Said another way, the fact that a page table has no valid entries does not guarantee that upper level table entries won't be accessed and cached in the processor, as long as those upper level entries are marked as present. For this reason, it is not safe to modify an upper level entry, even if no valid lower-level entries exist, without first clearing its present bit, followed by an INVLPG instruction.

**Use of Cached Entries When Reporting a Page Fault Exception.** On current AMD64 processors, when any type of page fault exception is encountered by the MMU, any cached upper-level entries that lead to the faulting entry are flushed (along with the TLB entry, if already cached) and the table walk is repeated to confirm the page fault using the table entries in memory. This is done because a table entry is allowed to be upgraded (by marking it as present, or by removing its write, execute or supervisor restrictions) without explicitly maintaining TLB coherency. Such an upgrade will be found when the table is re-walked, which resolves the fault. If the fault is confirmed on the re-walk however, a page fault exception is reported, and upper level entries that may have been cached on the re-walk are flushed.

**Handling of D-Bit Updates.** When the processor needs to set the D bit in the PTE for a TLB entry that is already marked as writable at all cached TLB levels, the table walk that is performed to access the PTE in memory may use cached upper level table entries. This differs from the fault situation previously described, in which cached entries aren't used to confirm the fault during the table walk.

**Invalidation of Cached Upper-level Entries by INVLPG.** The effect of INVLPG on TLB caching of upper-level page table entries is controlled by EFER[TCE] on processors that support the translation cache extension feature. If EFER[TCE] is 0, or if the processor does not support the translation cache extension feature, an INVLPG will flush all upper-level page table entries in the TLB as well as the target PTE. If EFER[TCE] is 1, INVLPG will flush only those upper-level entries that lead to the target PTE, along with the target PTE itself. INVLPGA may flush all upper-level entries regardless of the state of TCE. For further details, see Section 3.1.7 “Extended Feature Enable Register (EFER)” on page 55.

**Handling of PDPT Entries in PAE Mode.** When 32-bit PAE mode is enabled on AMD64 processors (CR4.PAE is set to 1) a third level of the address translation table hierarchy, the page directory pointer table (PDPT), is enabled. This table contains four entries. On current AMD64 processors, in native mode, these four entries are unconditionally loaded into the table walk cache whenever CR3 is written with the PDPT base address, and remain locked in. At this point they are also checked for reserved bit violations, and if such violations are present a general protection fault occurs.

Under SVM, however, when the processor is in guest mode with PAE enabled, the guest PDPT entries are not cached or validated at this point, but instead are loaded and checked on demand in the normal course of address translation, just like page directory and page table entries. Any reserved bit violations are detected at the point of use, and result in a page fault (#PF) exception rather than a



general protection (#GP) fault. The cached PDPT entries are subject to displacement from the table walk cache and reloading from the PDPT, hence software must assume that the PDPT entries may be read by the processor at any point while those tables are active. Future AMD processors may implement this same behavior in native mode as well, rather than pre-loading the PDPT entries.

## 5.6 Page-Protection Checks

The AMD64 architecture provides four forms of page-level memory protection. The first form of protection prevents non-privileged (user) code from accessing privileged (supervisor) code and data. The second form of protection prevents writes into read-only address spaces. The remaining two forms of page-level memory protection prevent the processor from fetching instructions from pages that are either known to contain non-executable data or that are accessible by user-mode code.

Access protection checks are performed when a virtual address is translated into a physical address. For those checks, the processor examines the page-level memory-protection bits in the translation tables to determine if the access is allowed. The page table bits involved in these checks are:

- User/Supervisor (U/S)—See “User/Supervisor (U/S) Bit” on page 139.
- Read/Write (R/W)—See “Read/Write (R/W) Bit” on page 139.
- No-Execute (NX)—See “No Execute (NX) Bit” on page 140.

Access protection actions taken by the processor are controlled by the following bits:

- Write-Protect enable (CR0.WP)—See “Write Protect (WP) Bit” on page 44.
- No-Execute Enable (EFER.NXE)—See “No-Execute Enable (NXE) Bit” on page 57
- Supervisor-mode Execution Prevention enable (CR4.SMEP)—See “Supervisor Mode Execution Prevention (SMEP)” on page 51

These protection checks are available at all levels of the page-translation hierarchy.

### 5.6.1 User/Supervisor (U/S) Bit

The U/S bit in the page-translation tables determines the privilege level required to access the page. Conceptually, user (non-privileged) pages correspond to a current privilege-level (CPL) of 3, or least-privileged. Supervisor (privileged) pages correspond to a CPL of 0, 1, or 2, all of which are jointly regarded as most-privileged.

When the processor is running at a CPL of 0, 1, or 2, it can access both user and supervisor pages. However, when the processor is running at a CPL of 3, it can only access user pages. If an attempt is made to access a supervisor page while the processor is running at CPL = 3, a page-fault exception (#PF) occurs.

See “Privilege-Level Concept” on page 96 for more information on processor privilege levels.

### 5.6.2 Read/Write (R/W) Bit

The R/W bit in the page-translation tables specifies the access type allowed for the page. If R/W=1, the page is read/write. If R/W = 0, the page is read-only. A page-fault exception (#PF) occurs if an attempt is made by user software to write to a read-only page. If supervisor software attempts to write a read-only page, the outcome depends on the value of the CR0.WP bit (described below).

### 5.6.3 No Execute (NX) Bit

The NX bit provides the ability to mark a page as non-executable. If the NX bit is set at any level of the page-table hierarchy in the table entries traversed during a table walk, the page mapped by those entries is a no-execute page. When no-execute protection is enabled, any attempt to fetch an instruction from a no-execute page results in a page-fault exception (#PF).

The no-execute protection check applies to all privilege levels. It does not distinguish between supervisor and user-level accesses.

The no-execute protection feature is supported only in PAE-paging mode. In 32-bit PAE mode, the NX bit is not supported at the Page Directory Pointer table level. In this mode, the value of the NX bit at the PDP level defaults to 0.

No-execute protection is enabled by setting the NXE bit in the EFER register to 1. Before setting this bit, system software must verify the processor supports the no-execute feature by checking the CPUID NX feature flag (CPUID Fn8000\_0001\_EDX[NX]).

### 5.6.4 Write Protect (CR0.WP) Bit

The ability to write to read-only pages is governed by the processor mode and whether write protection is enabled. If write protection is *not* enabled, a processor running at CPL 0, 1, or 2 can write to any physical page, even if it is marked as read-only. Enabling write protection by setting the WP bit in CR0 prevents supervisor code from writing into read-only pages, including read-only user-level pages.

A page-fault exception (#PF) occurs if software attempts to write (at any privilege level) into a read-only page while write protection is enabled.

### 5.6.5 Supervisor-Mode Execution Prevention (CR4.SMEP) Bit

When supported and enabled, a page-fault exception (#PF) is asserted if the processor attempts to fetch an instruction from a user page while running at CPL 0, 1, or 2. A user page is any page with the U/S bit set to 1, and thus accessible when the processor is running at CPL = 3.

Supervisor-mode execution prevention is enabled by setting the SMEP bit (bit 20) in the CR4 register to 1. Before setting this bit, system software must verify the processor supports the SMEP feature by checking the SMEP feature flag (CPUID Fn0000\_0007\_EBX[SMEP]\_x0 = 1).

For more information using the CPUID instruction see Section 3.3 “Processor Feature Identification” on page 63.

## 5.7 Protection Across Paging Hierarchy

The privilege level and access type specified at each level of the page-translation hierarchy have a combined effect on the protection of the translated physical page. Enabling and disabling write protection CR0 [WP] further qualifies the protection effect on the physical page.

Table 5-2 shows the overall effect that privilege level and access type have on physical-page protection when write protection is disabled (CR0.WP=0). In this case, when *any* translation-table entry is specified as supervisor level, the physical page is a supervisor page and can only be accessed by software running at CPL 0, 1, or 2. Such a page allows read/write access even if all levels of the page-translation hierarchy specify read-only access.

**Table 5-2. Physical-Page Protection, CR0.WP=0**

Page-Map Level-4 Entry		Page-Directory-Pointer Entry		Page-Directory Entry		Page-Table Entry		Effective Result on Physical Page	
U/S	R/W	U/S	R/W	U/S	R/W	U/S	R/W	U/S	R/W
S	—	—	—	—	—	—	—	S	R/W
—	—	S	—	—	—	—	—		
—	—	—	—	S	—	—	—		
—	—	—	—	—	—	S	—	U	R <sup>1</sup>
U	R	U	—	U	—	U	—		
U	—	U	R	U	—	U	—		
U	—	U	—	U	R	U	—		
U	—	U	—	U	—	U	R	U	R/W
U	R/W	U	R/W	U	R/W	U	R/W		

**Note:**  
*S = Supervisor Level (CPL=0, 1, or 2), U = User Level (CPL = 3), R = Read-Only Access, R/W = Read/Write Access, — = Don't Care.*

**Note:**  
 1. *Supervisor-level programs can access these pages as R/W.*

If *all* table entries in the translation hierarchy are specified as user level the physical page is a user page, and both supervisor and user software can access it. In this case the physical page is read-only if any table entry in the translation hierarchy specifies read-only access. All table entries in the translation hierarchy must specify read/write access for the physical page to be read/write.

Table 5-3 shows the overall effect that privilege level and access type have on physical-page access when write protection is enabled (CR0.WP=1). When any translation-table entry is specified as supervisor level, the physical page is a supervisor page and can only be accessed by supervisor software. In this case, the physical page is read-only if any table entry in the translation hierarchy specifies read-only access. All table entries in the translation hierarchy must specify read/write access for the supervisor page to be read/write.

Table 5-3. Effect of CR0.WP=1 on Supervisor Page Access

Page-Map Level-4 Entry	Page Directory-Pointer Entry	Page Directory Entry	Page Table Entry	Physical Page
R/W	R/W	R/W	R/W	R/W
R	—	—	—	R
—	R	—	—	
—	—	R	—	
—	—	—	R	
W	W	W	W	W
<b>Note:</b> R = Read-Only Access Type, W = Read/Write Access Type, — = Don't Care. Physical page is in supervisor mode, as determined by U/S settings in Table 5-2.				

### 5.7.1 Access to User Pages when CR0.WP=1

As shown in Table 5-2 on page 147, read/write access to user-level pages behaves the same as when write protection is disabled (CR0.WP=0), with one critical difference. When write protection is enabled, supervisor programs cannot write into read-only user pages.

## 5.8 Effects of Segment Protection

Segment-protection and page-protection checks are performed serially by the processor, with segment-privilege checks performed first, followed by page-protection checks. Page-protection checks are not performed if a segment-protection violation is found. If a violation is found during either segment-protection or page-protection checking, an exception occurs and no memory access is performed. Segment-protection violations cause either a general-protection exception (#GP) or a stack exception (#SS) to occur. Page-protection violations cause a page-fault exception (#PF) to occur.

## 6 System-Management Instructions

System-management instructions provide control over the resources used to manage the processor operating environment. This includes memory management, memory protection, task management, interrupt and exception handling, system-management mode, software debug and performance analysis, and model-specific features. Most instructions used to access these resources are privileged and can only be executed while the processor is running at CPL=0, although some instructions can be executed at any privilege level.

Table 6-1 summarizes the instructions used for system management. These include all privileged instructions, instructions whose privilege requirement is under the control of system software, non-privileged instructions that are used primarily by system software, and instructions used to transfer control to system software. Most of the instructions listed in Table 6-1 are summarized in this chapter, although a few are introduced elsewhere in this manual, as indicated in the *Reference* column of Table 6-1.

For details on individual system instructions, see “System Instruction Reference” in Volume 3.

**Table 6-1. System Management Instructions**

Mnemonic	Name	Privilege			Reference
		CPL=0	O/S <sup>1</sup>	Any	
ARPL	Adjust Requestor Privilege Level			X	“Adjusting Access Rights” on page 159
CLGI	Clear Global Interrupt Flag	X			“Global Interrupt Flag, STGI and CLGI Instructions” on page 474
CLI	Clear Interrupt Flag		X		“CLI and STI Instructions” on page 156
CLTS	Clear Task-Switched Flag in CR0	X			“CLTS Instruction” on page 156
HLT	Halt	X			“Processor Halt” on page 159
INT3	Interrupt to Debug Vector			X	“Breakpoint Instruction (INT3)” on page 360
INVD	Invalidate Caches	X			“Cache Management” on page 159
INVLPG	Invalidate TLB Entry	X			“TLB Invalidation” on page 160
INVLPGA	Invalidate TLB Entry in a Specified ASID	X			“Invalidate Page, Alternate ASID” on page 474
IRET <sub>x</sub>	Interrupt Return (all forms)			X	“Returning From Interrupt Procedures” on page 244
LAR	Load Access-Rights Byte			X	“Checking Access Rights” on page 158

**Note:**

1. The operating system controls the privilege required to use the instruction.

Table 6-1. System Management Instructions (continued)

Mnemonic	Name	Privilege			Reference
		CPL=0	O/S <sup>1</sup>	Any	
LGDT	Load Global-Descriptor-Table Register	X			“LGDT and LIDT Instructions” on page 158
LIDT	Load Interrupt-Descriptor-Table Register	X			
LLDT	Load Local-Descriptor-Table Register	X			“LLDT and LTR Instructions” on page 158
LMSW	Load Machine-Status Word	X			“LMSW and SMSW Instructions” on page 156
LSL	Load Segment Limit			X	“Checking Segment Limits” on page 158
LTR	Load Task Register	X			“LLDT and LTR Instructions” on page 158
MONITOR	Setup Monitor Address		X		--
MOV CR <sub>n</sub>	Move to/from Control Registers	X			“MOV CR <sub>n</sub> Instructions” on page 155
MOV DR <sub>n</sub>	Move to/from Debug Registers	X			“Accessing Debug Registers” on page 156
MWAIT	Monitor Wait		X		--
RDFSBASE	Read FS Base Address			X	“RDFSBASE, RDGSBASE, WRFSBASE, and WRGSBASE Instructions” on page 157
RDGSBASE	Read GS Base Address			X	
RDMSR	Read Model-Specific Register	X			“RDMSR and WRMSR Instructions” on page 156
RDPMC	Read Performance-Monitor Counter		X		“RDPMC Instruction” on page 156
RDTSR	Read Time-Stamp Counter		X		“RDTSR Instruction” on page 157
RDTSRCP	Read Time-Stamp Counter and Processor ID		X		“RDTSRCP Instruction” on page 157
RSM	Return from System-Management Mode			X	“Leaving SMM” on page 298
SGDT	Store Global-Descriptor-Table Register			X	“SGDT and SIDT Instructions” on page 158
SIDT	Store Interrupt-Descriptor-Table Register			X	
SKINIT	Secure Init and Jump with Attestation	X			“Security” on page 498
SLDT	Store Local-Descriptor-Table Register			X	“SLDT and STR Instructions” on page 158

**Note:**

1. The operating system controls the privilege required to use the instruction.

Table 6-1. System Management Instructions (continued)

Mnemonic	Name	Privilege			Reference
		CPL=0	O/S <sup>1</sup>	Any	
SMSW	Store Machine-Status Word			X	"LMSW and SMSW Instructions" on page 156
STI	Set Interrupt Flag		X		"CLI and STI Instructions" on page 156
STGI	Set Global Interrupt Flag	X			"Global Interrupt Flag, STGI and CLGI Instructions" on page 474
STR	Store Task Register			X	"SLDT and STR Instructions" on page 158
SWAPGS	Swap GS and KernelGSbase Registers	X			"SWAPGS Instruction" on page 155
SYSCALL	Fast System Call			X	"SYSCALL and SYSRET" on page 152
SYSENTER	System Call			X	"SYSENTER and SYSEXIT (Legacy Mode Only)" on page 154
SYSEXIT	System Return	X			
SYSRET	Fast System Return	X			"SYSCALL and SYSRET" on page 152
UD2	Undefined Operation			X	"System Instruction Reference" in Volume 3
VERR	Verify Segment for Reads			X	"Checking Read/Write Rights" on page 158
VERW	Verify Segment for Writes			X	
VMLOAD	Load State from VMCB	X			"VMSAVE and VMLOAD Instructions" on page 470
VMMCALL	Call VMM	X			"VMMCALL Instruction" on page 475
VMRUN	Run Virtual Machine	X			"VMRUN Instruction" on page 447
VMSAVE	Save State to VMCB	X			"VMSAVE and VMLOAD Instructions" on page 470
WBINVD	Writeback and Invalidate Caches	X			"Cache Management" on page 159
WRFSBASE	Write FS Base Address			X	"RDFSBASE, RDGSBASE, WRFSBASE, and WRGSBASE Instructions" on page 157
WRGSBASE	Write GS Base Address			X	
WRMSR	Write Model-Specific Register	X			"RDMSR and WRMSR Instructions" on page 156

**Note:**  
1. The operating system controls the privilege required to use the instruction.

The following instructions are summarized in this chapter but are not categorized as system instructions, because of their importance to application programming:

- The CPUID instruction returns information critical to system software in initializing the operating environment. It is fully described in Section 3.3, “Processor Feature Identification,” on page 63.
- The PUSHF and POPF instructions set and clear certain RFLAGS bits depending on the processor operating mode and privilege level. These dependencies are described in “POPF and PUSHF Instructions” on page 156.
- The MOV, PUSH, and POP instructions can be used to load and store segment registers, as described in “MOV, POP, and PUSH Instructions” on page 157.

## 6.1 Fast System Call and Return

Operating systems can use both paging and segmentation to implement protected memory models. Segment descriptors provide the necessary memory protection and privilege checking for segment accesses. By setting segment-descriptor fields appropriately, operating systems can enforce access restrictions as needed.

A disadvantage of segment-based protection and privilege checking is the overhead associated with loading a new segment selector (and its corresponding descriptor) into a segment register. Even when using the flat-memory model, this overhead still occurs when switching between privilege levels because code segments (CS) and stack segments (SS) are reloaded with different segment descriptors.

To initiate a call to the operating system, an application transfers control to the operating system through a gate descriptor (call, interrupt, trap, or task gate). In the past, control was transferred using either a far CALL instruction or a software interrupt. Transferring control through one of these gates is slowed by the segmentation-related overhead, as is the later return using a far RET or IRET instruction. The following checks are performed when control is transferred in this manner:

- Selectors, gate descriptors, and segment descriptors are in the proper form.
- Descriptors lie within the bounds of the descriptor tables.
- Gate descriptors reference the appropriate segment descriptors.
- The caller, gate, and target privileges all allow the control transfer to take place.
- The stack created by the call has sufficient properties to allow the transfer to take place.

In addition to these call-gate checks, other checks are made involving the task-state segment when a task switch occurs.

### 6.1.1 SYSCALL and SYSRET

**SYSCALL and SYSRET Instructions.** SYSCALL and SYSRET are low-latency system call and return instructions. These instructions assume the operating system implements a flat-memory model, which greatly simplifies calls to and returns from the operating system. This simplification comes from eliminating unneeded checks, and by loading pre-determined values into the CS and SS segment registers (both visible and hidden portions). As a result, SYSCALL and SYSRET can take fewer than one-fourth the number of internal clock cycles to complete than the legacy CALL and RET



instructions. SYSCALL and SYSRET are particularly well-suited for use in 64-bit mode, which requires implementation of a paged, flat-memory model.

SYSCALL and SYSRET require that the code-segment base, limit, and attributes (except for CPL) are consistent for all application and system processes. Only the CPL is allowed to vary. The processor assumes (but does not check) that the SYSCALL target CS has CPL=0 and the SYSRET target CS has CPL=3.

For details on the SYSCALL and SYSRET instructions, see “System Instruction Reference” in Volume 3.

**SYSCALL and SYSRET MSRs.** The STAR, LSTAR, and CSTAR registers are model-specific registers (MSRs) used to specify the target address of a SYSCALL instruction as well as the CS and SS selectors of the called and returned procedures. The SFMASK register is used in long mode to specify how rFLAGS is handled by these instructions. Figure 6-1 shows the STAR, LSTAR, CSTAR, and SFMASK register formats.

		63	48	47	32	31	0
<b>STAR</b>	C000_0081h	SYSRET CS and SS		SYSCALL CS and SS		32-bit SYSCALL Target EIP	
<b>LSTAR</b>	C000_0082h	Target RIP for 64-Bit-Mode Calling Software					
<b>CSTAR</b>	C000_0083h	Target RIP for Compatibility-Mode Calling Software					
<b>SFMASK</b>	C000_0084h	Reserved, RAZ				SYSCALL Flag Mask	

**Figure 6-1. STAR, LSTAR, CSTAR, and MASK MSRs**

- *STAR*—The STAR register has the following fields (unless otherwise noted, all bits are read/write):
  - *SYSRET CS and SS Selectors*—Bits 63:48. This field is used to specify both the CS and SS selectors loaded into CS and SS during SYSRET. If SYSRET is returning to 32-bit mode (either legacy or compatibility), this field is copied directly into the CS selector field. If SYSRET is returning to 64-bit mode, the CS selector is set to this field + 16. SS.Sel is set to this field + 8, regardless of the target mode. Because SYSRET always returns to CPL 3, the RPL bits 49:48 should be initialized to 11b.
  - *SYSCALL CS and SS Selectors*—Bits 47:32. This field is used to specify both the CS and SS selectors loaded into CS and SS during SYSCALL. This field is copied directly into CS.Sel. SS.Sel is set to this field + 8. Because SYSCALL always switches to CPL 0, the RPL bits 33:32 should be initialized to 00b.
  - *32-bit SYSCALL Target EIP*—Bits 31:0. This is the target EIP of the called procedure.

The legacy STAR register is not expanded in long mode to provide a 64-bit target RIP address. Instead, long mode provides two new STAR registers—long STAR (LSTAR) and compatibility STAR (CSTAR)—that hold a 64-bit target RIP.

- *LSTAR and CSTAR*—The LSTAR register holds the target RIP of the called procedure in long mode when the calling software is in 64-bit mode. The CSTAR register holds the target RIP of the called procedure in long mode when the calling software is in compatibility mode. The WRMSR instruction is used to load the target RIP into the LSTAR and CSTAR registers. If the RIP written to either of the MSRs is not in canonical form, a #GP fault is generated on the WRMSR instruction.
- *SFmask*—The SFMASK register is used to specify which RFLAGS bits are cleared during a SYSCALL. In long mode, SFMASK is used to specify which RFLAGS bits are cleared when SYSCALL is executed. If a bit in SFMASK is *set to 1*, the corresponding bit in RFLAGS is *cleared to 0*. If a bit in SFMASK is cleared to 0, the corresponding rFLAGS bit is not modified.

### 6.1.2 SYSENTER and SYSEXIT (Legacy Mode Only)

**SYSENTER and SYSEXIT Instructions.** Like SYSCALL and SYSRET, SYSENTER and SYSEXIT are low-latency system call and return instructions designed for use by system and application software implementing a flat-memory model. However, *these instructions are illegal in long mode and result in an undefined opcode exception (#UD) if software attempts to use them.* Software should use the SYSCALL and SYSRET instructions when running in long mode.

**SYSENTER and SYSEXIT MSRs.** Three model-specific registers (MSRs) are used to specify the target address and stack pointers for the SYSENTER instruction as well as the CS and SS selectors of the called and returned procedures. The register fields are:

- *SYSENTER Target CS*—Holds the CS selector of the called procedure.
- *SYSENTER Target ESP*—Holds the called-procedure stack pointer. The SS selector is updated automatically to point to the next descriptor entry after the SYSENTER Target CS, and ESP is the offset into that stack segment.
- *SYSENTER Target EIP*—Holds the offset into the CS of the called procedure.

Figure 6-2 shows the register formats and their corresponding MSR IDs.

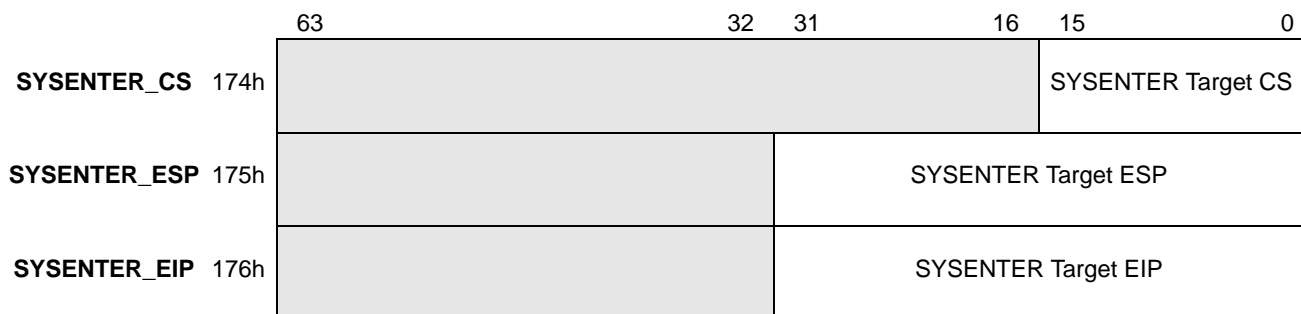

**Figure 6-2. SYSENTER\_CS, SYSENTER\_ESP, SYSENTER\_EIP MSRs**

### 6.1.3 SWAPGS Instruction

The SWAPGS instruction provides a fast method for system software to load a pointer to system data structures. SWAPGS can be used upon entering system-software routines as a result of a SYSCALL instruction or as a result of an interrupt or exception. Before returning to application software, SWAPGS can restore an application data-structure pointer that was replaced by the system data-structure pointer.

SWAPGS exchanges the base-address value located in the KernelGSbase model-specific register (MSR address C000\_0102h) with the base-address value located in the hidden portion of the GS selector register (GS.base). This exchange allows the system-kernel software to quickly access kernel data structures by using the GS segment-override prefix during memory references.

The need for SwapGS arises from the requirement that, upon entry to the OS kernel, the kernel needs to obtain a 64-bit pointer to its essential data structures. When using SYSCALL to implement system calls, no kernel stack exists at the OS entry point. Neither is there a straightforward method to obtain a pointer to kernel structures, from which the kernel stack pointer could be read. Thus, the kernel cannot save GPRs or reference memory. SwapGS does not require any GPR or memory operands, so no registers need to be saved before using it. Similarly, when the OS kernel is entered via an interrupt or exception (where the kernel stack is already set up), SwapGS can be used to quickly get a pointer to the kernel data structures.

See “FS and GS Registers in 64-Bit Mode” on page 72 for more information on using the GS.base register in 64-bit mode.

## 6.2 System Status and Control

System-status and system-control instructions are used to determine the features supported by a processor, gather information about the current execution state, and control the processor operating modes.

### 6.2.1 Processor Feature Identification (CPUID)

**CPUID Instruction.** The CPUID instruction provides complete information about the processor implementation and its capabilities. Software operating at any privilege level can execute the CPUID instruction to collect this information. System software normally uses the CPUID instruction to determine which optional features are available so the system can be configured appropriately. See Section 3.3, “Processor Feature Identification,” on page 63.

### 6.2.2 Accessing Control Registers

**MOV CR $n$  Instructions.** The MOV CR $n$  instructions can be used to copy data between the control registers and the general-purpose registers. These instructions are privileged and cause a general-protection exception (#GP) if non-privileged software attempts to execute them.

**LMSW and SMSW Instructions.** The machine status word is located in CR0 register bits 15:0. The *load machine status word* (LMSW) instruction writes only the least-significant four status-word bits (CR0[3:0]). All remaining status-word bits (CR0[15:4]) are left unmodified by the instruction. The instruction is privileged and causes a #GP to occur if non-privileged software attempts to execute it.

The *store machine status word* (SMSW) instruction stores all 16 status-word bits (CR0[15:0]) into the target GPR or memory location. The instruction is not privileged and can be executed by all software.

**CLTS Instruction.** The *clear task-switched bit* instruction (CLTS) clears CR0.TS to 0. The CR0.TS bit is set to 1 by the processor every time a task switch takes place. The bit is useful to system software in determining when the x87 and multimedia register state should be saved or restored. See “Task Switched (TS) Bit” on page 44 for more information on using CR0.TS to manage x87-instruction state. The CLTS instruction is privileged and causes a #GP to occur if non-privileged software attempts to execute it.

### 6.2.3 Accessing the RFLAGS Register

The RFLAGS register contains both application and system bits. This section describes the instructions used to read and write system bits. Descriptions of instruction effects on application flags can be found in “Flags Register” in Volume 1 and “Instruction Effects on RFLAGS” in Volume 3.

**POPF and PUSHF Instructions.** The *pop and push RFLAGS* instructions are used for moving data between the rFLAGS register and the stack. They are not system-management instructions, but their behavior is mode-dependent.

**CLI and STI Instructions.** The *clear interrupt* (CLI) and *set interrupt* (STI) instructions modify only the RFLAGS.IF bit or RFLAGS.VIF bit. Clearing rFLAGS.IF to 0 causes the processor to ignore maskable interrupts. Setting RFLAGS.IF to 1 causes the processor to allow maskable interrupts.

See “Virtual Interrupts” on page 253 for more information on the operation of these instructions when virtual-8086 mode extensions are enabled (CR4.VME=1).

### 6.2.4 Accessing Debug Registers

The MOV DR<sub>n</sub> instructions are used to copy data between the debug registers and the general-purpose registers. These instructions are privileged and cause a general-protection exception (#GP) if non-privileged software attempts to execute them. See “Debug Registers” on page 348 for a detailed description of the debug registers.

### 6.2.5 Accessing Model-Specific Registers

**RDMSR and WRMSR Instructions.** The *read/write model-specific register* instructions (RDMSR and WRMSR) can be used by privileged software to access the 64-bit MSRs. See “Model-Specific Registers (MSRs)” on page 58 for details about the MSRs.

**RDPMC Instruction.** The *read performance-monitoring counter* instruction, RDPMC, is used to read the model-specific performance-monitoring counter registers.

**RDTSC Instruction.** The *read time-stamp counter* instruction, RDTSC, is used to read the model-specific time-stamp counter (TSC) register.

**RDTSCP Instruction.** The *read time-stamp counter and processor ID* instruction, RDTSCP, is used to read the model-specific time-stamp counter (TSC) register, as well as the low 32 bits of the TSC\_AUX register (MSR C000\_0103h).

## 6.3 Segment Register and Descriptor Register Access

The AMD64 architecture supports the legacy instructions that load and store segment registers and descriptor registers. In some cases the instruction capabilities are expanded to support long mode.

### 6.3.1 Accessing Segment Registers

**MOV, POP, and PUSH Instructions.** The MOV and POP instructions can be used to load a selector into a segment register from a general-purpose register or memory (MOV) or from the stack (POP). Any segment register, except the CS register, can be loaded with the MOV and POP instructions. The CS register must be loaded with a far-transfer instruction.

All segment register selectors can be stored in a general-purpose register or memory using the MOV instruction or pushed onto the stack using the PUSH instruction.

When a selector is loaded into a segment register, the processor automatically loads the corresponding descriptor-table entry into the hidden portion of the selector register. The hidden portion contains the base address, limit, and segment attributes.

Segment-load and segment-store instructions work normally in 64-bit mode. The appropriate entry is read from the system descriptor table (GDT or LDT) and is loaded into the hidden portion of the segment descriptor register. However, the contents of data-segment and stack-segment descriptor registers are ignored, except in the case of the FS and GS segment-register base fields—see “FS and GS Registers in 64-Bit Mode” on page 72 for more information.

The ability to use segment-load instructions allows a 64-bit operating system to set up segment registers for a compatibility-mode application before switching to compatibility mode.

### 6.3.2 Accessing Segment Register Hidden State

**WRMSR and RDMSR Instructions.** The base address field of the hidden state of the FS and GS registers are mapped to MSRs and may be read and written by privileged software when running in 64-bit mode.

**RDFSBASE, RDGSBASE, WRFSBASE, and WRGSBASE Instructions.** When supported and enabled, these instructions allow software running at any privilege level to read and write the base address field of the hidden state of the FS and GS segment registers. These instructions are only defined in 64-bit mode.

### 6.3.3 Accessing Descriptor-Table Registers

**LGDT and LIDT Instructions.** The *load GDTR* (LGDT) and *load IDTR* (LIDT) instructions load a *pseudo-descriptor* from memory into the GDTR or IDTR registers, respectively.

**LLDT and LTR Instructions.** The *load LDTR* (LLDT) and *load TR* (LTR) instructions load a system-segment descriptor from the GDT into the LDTR and TR segment-descriptor registers (hidden portion), respectively.

**SGDT and SIDT Instructions.** The *store GDTR* (SGDT) and *store IDTR* (SIDT) instructions reverse the operation of the LGDT and LIDT instructions. SGDT and SIDT store a pseudo-descriptor from the GDTR or IDTR register into memory.

**SLDT and STR Instructions.** In all modes, the *store LDTR* (SLDT) and *store TR* (STR) instructions store the LDT or task selector from the visible portion of the LDTR or TR register into a general-purpose register or memory, respectively. The hidden portion of the LDTR or TR register is not stored.

## 6.4 Protection Checking

Several instructions are provided to allow software to determine the outcome of a protection check before performing a memory access that could result in a protection violation. By performing the checks before a memory access, software can avoid violations that result in a general-protection exception (#GP).

### 6.4.1 Checking Access Rights

**LAR Instruction.** The *load access-rights* (LAR) instruction can be used to determine if access to a segment is allowed, based on privilege checks and type checks. The LAR instruction uses a segment-selector in the source operand to reference a descriptor in the GDT or LDT. LAR performs a set of access-rights checks and, if successful, loads the segment-descriptor access rights into the destination register. Software can further examine the access-rights bits to determine if access into the segment is allowed.

### 6.4.2 Checking Segment Limits

**LSL Instruction.** The *load segment-limit* (LSL) instruction uses a segment-selector in the source operand to reference a descriptor in the GDT or LDT. LSL performs a set of preliminary access-rights checks and, if successful, loads the segment-descriptor limit field into the destination register. Software can use the limit value in comparisons with pointer offsets to prevent segment limit violations.

### 6.4.3 Checking Read/Write Rights

**VERR and VERW Instructions.** The *verify read-rights* (VERR) and *verify write-rights* (VERW) can be used to determine if a target code or data segment (not a system segment) can be read or written from the current privilege level (CPL). The source operand for these instructions is a pointer to the

segment selector to be tested. If the tested segment (code or data) is readable from the current CPL, the VERR instruction sets RFLAGS.ZF to 1; otherwise, it is cleared to zero. Likewise, if the tested data segment is writable, the VERW instruction sets the RFLAGS.ZF to 1. A code segment cannot be tested for writability.

#### 6.4.4 Adjusting Access Rights

**ARPL Instruction.** The *adjust RPL-field* (ARPL) instruction can be used by system software to prevent access into privileged-data segments by lower-privileged software. This can happen if an application passes a selector to system software and the selector RPL is less than (has greater privilege than) the calling-application CPL. To prevent this surrogate access, system software executes ARPL with the following operands:

- The destination operand is the data-segment selector passed to system software by the application.
- The source operand is the application code-segment selector (available on the system-software stack as a result of the CALL into system software by the application).

ARPL is not supported in 64-bit mode.

## 6.5 Processor Halt

The *processor halt* instruction (HLT) halts instruction execution, leaving the processor in the halt state. No registers or machine state are modified as a result of executing the HLT instruction. The processor remains in the halt state until one of the following occurs:

- A non-maskable interrupt (NMI).
- An enabled, maskable interrupt (INTR).
- Processor reset (RESET).
- Processor initialization (INIT).
- System-management interrupt (SMI).

## 6.6 Cache and TLB Management

Cache-management instructions are used by system software to maintain coherency within the memory hierarchy. Memory coherency and caches are discussed in Chapter 7, “Memory System.” Similarly, TLB-management instructions are used to maintain coherency between page translations cached in the TLB and the translation tables maintained by system software in memory. See “Translation-Lookaside Buffer (TLB)” on page 141 for more information.

### 6.6.1 Cache Management

**WBINVD Instruction.** The *writeback and invalidate* (WBINVD) instruction is used to write all modified cache lines to memory so that memory contains the most recent copy of data. After the writes

are complete, the instruction invalidates all cache lines. This instruction operates on all caches in the memory hierarchy, including caches that are external to the processor.

**INVD Instruction.** The *invalidate* (INVD) instruction is used to invalidate all cache lines in all caches in the memory hierarchy. Unlike the WBINVD instruction, no modified cache lines are written to memory. The INVD instruction should only be used in situations where memory coherency is not required.

### 6.6.2 TLB Invalidation

**INVLPG Instruction.** The *invalidate TLB entry* (INVLPG) instruction can be used to invalidate specific entries within the TLB. The source operand is a virtual-memory address that specifies the TLB entry to be invalidated. Invalidating a TLB entry does not remove the associated page-table entry from the data cache. See “Translation-Lookaside Buffer (TLB)” on page 141 for more information.



---

## 7 Memory System

---

This chapter describes:

- Cache coherency mechanisms
- Cache control mechanisms
- Memory typing
- Memory mapped I/O
- Memory ordering rules
- Serializing instructions

Figure 7-1 on page 162 shows a conceptual picture of a processor and memory system, and how data and instructions flow between the various components. This diagram is not intended to represent a specific microarchitectural implementation but instead is used to illustrate the major memory-system components covered by this chapter.



- *L1 Data Cache*—The L1 (level-1) data cache holds the data most recently read or written by the software running on the processor.
- *L1 Instruction Cache*—The L1 instruction cache is similar to the L1 data cache except that it holds only the instructions executed most frequently. In some processor implementations, the L1 instruction cache can be combined with the L1 data cache to form a unified L1 cache.
- *L2 Cache*—The L2 (level-2) cache is usually several times larger than the L1 caches, but it is also slower. It is common for L2 caches to be implemented as a unified cache containing both instructions and data. Recently used instructions and data that do not fit within the L1 caches can reside in the L2 cache. The L2 cache can be exclusive, meaning it does not cache information contained in the L1 cache. Conversely, inclusive L2 caches contain a copy of the L1-cached information.

Memory-read operations from cacheable memory first check the cache to see if the requested information is available. A *read hit* occurs if the information is available in the cache, and a *read miss* occurs if the information is not available. Likewise, a *write hit* occurs if the memory write can be stored in the cache, and a *write miss* occurs if it cannot be stored in the cache.

Caches are divided into fixed-size blocks called *cache lines*. The cache allocates lines to correspond to regions in memory of the same size as the cache line, aligned on an address boundary equal to the cache-line size. For example, in a cache with 32-byte lines, the cache lines are aligned on 32-byte boundaries and byte addresses 0007h and 001Eh are both located in the same cache line. The size of a cache line is implementation dependent. Most implementations have either 32-byte or 64-byte cache lines.

The process of loading data into a cache is a *cache-line fill*. Even if only a single byte is requested, all bytes in a cache line are loaded from memory. Typically, a cache-line fill must remove (evict) an existing cache line to make room for the new line loaded from memory. This process is called *cache-line replacement*. If the existing cache line was modified before the replacement, the processor performs a cache-line *writeback* to main memory when it performs the cache-line fill.

Cache-line writebacks help maintain *coherency* between the caches and main memory. Internally, the processor can also maintain cache coherency by *internally probing* (checking) the other caches and write buffers for a more recent version of the requested data. External devices can also check processor caches for more recent versions of data by *externally probing* the processor. Throughout this document, the term *probe* is used to refer to external probes, while internal probes are always qualified with the word *internal*.

*Write buffers* temporarily hold data writes when main memory or the caches are busy with other memory accesses. The existence of write buffers is implementation dependent.

Implementations of the architecture can use *write-combining buffers* if the order and size of non-cacheable writes to main memory is not important to the operation of software. These buffers can combine multiple, individual writes to main memory and transfer the data in fewer bus transactions.

## 7.1 Single-Processor Memory Access Ordering

The flexibility with which memory accesses can be ordered is closely related to the flexibility in which a processor implementation can *execute* and *retire* instructions. Instruction execution *creates* results and status and determines whether or not the instruction causes an exception. Instruction retirement *commits* the results of instruction execution, in program order, to software-visible resources such as memory, caches, write-combining buffers, and registers, or it causes an exception to occur if instruction execution created one.

Implementations of the AMD64 architecture retire instructions in program order, but implementations can execute instructions in any order, subject only to data dependencies. Implementations can also *speculatively execute* instructions—executing instructions before knowing they are needed. Internally, implementations manage data reads and writes so that instructions complete in order. However, because implementations can execute instructions out of order and speculatively, the sequence of memory accesses performed by the hardware can appear to be out of program order. The following sections describe the rules governing memory accesses to which processor implementations adhere. These rules may be further restricted, depending on the memory type being accessed. Further, these rules govern single processor operation; see “Multiprocessor Memory Access Ordering” on page 166 for multiprocessor ordering rules.

### 7.1.1 Read Ordering

Generally, reads do not affect program order because they do not affect the state of software-visible resources other than register contents. However, some system devices might be sensitive to reads. In such a situation software can map a read-sensitive device to a memory type that enforces strong read-ordering, or use read/write barrier instructions to force strong read-ordering.

For cacheable memory types, the following rules govern read ordering:

- Out-of-order reads are allowed to the extent that they can be performed transparently to software, such that the appearance of in-order execution is maintained. Out-of-order reads can occur as a result of out-of-order instruction execution or speculative execution. The processor can read memory and perform cache refills out-of-order to allow out-of-order execution to proceed.
- Speculative reads are allowed. A speculative read occurs when the processor begins executing a memory-read instruction before it knows the instruction will actually complete. For example, the processor can predict a branch will occur and begin executing instructions following the predicted branch before it knows whether the prediction is valid. When one of the speculative instructions reads data from memory, the read itself is speculative. Cache refills may also be performed speculatively.
- Reads can be reordered ahead of writes. Reads are generally given a higher priority by the processor than writes because instruction execution stalls if the read data required by an instruction is not immediately available. Allowing reads ahead of writes usually maximizes software performance.
- A read *cannot* be reordered ahead of a prior write if the read is from the same location as the prior write. In this case, the read instruction stalls until the write instruction completes execution. The

read instruction requires the result of the write instruction for proper software operation. For cacheable memory types, the write data can be forwarded to the read instruction before it is actually written to memory.

### 7.1.2 Write Ordering

Writes affect program order because they affect the state of software-visible resources. The following rules govern write ordering:

- Generally, out-of-order writes are *not* allowed. Write instructions executed out of order cannot commit (write) their result to memory until all previous instructions have completed in program order. The processor can, however, hold the result of an out-of-order write instruction in a private buffer (not visible to software) until that result can be committed to memory.
- It is possible for writes to *write-combining* memory types to appear to complete out of order, relative to writes into other memory types. See “Memory Types” on page 172 and “Write Combining” on page 178 for additional information.
- Speculative writes are *not* allowed. As with out-of-order writes, speculative write instructions cannot commit their result to memory until all previous instructions have completed in program order. Processors can hold the result in a private buffer (not visible to software) until the result can be committed.
- Write buffering is allowed. When a write instruction completes and commits its result, that result can be buffered until it is actually written to system memory in program order. Although the write buffer itself is not directly accessible by software, the results in the buffer are accessible by subsequent memory accesses to the locations that are buffered, including reads for which only a subset of bytes being accessed are in the buffer. For example, a doubleword read that overlaps a single modified byte in the write buffer can return the buffered value for that byte before that write has been committed to memory.

In general, any read from cacheable memory returns the net result of all prior globally and locally visible writes to those bytes, as performed in program order. A given implementation may provide bytes from the write buffer to satisfy this, or may stall the read until any overlapping buffered writes have been committed to memory. For cacheable memory types, the write buffer can be read out-of-order and speculatively, just like memory.

- Write combining is allowed. In some situations software can relax the write-ordering rules through the use of a Write Combining memory type or non-temporal store instructions, and allow several writes to be combined into fewer writes to memory. When write-combining is used, it is possible for writes to other memory types to proceed ahead of (out-of-order) memory-combining writes, unless the writes are to the same address. Write-combining should be used only when the order of writes does not affect program order (for example, writes to a graphics frame buffer).

### 7.1.3 Read/Write Barriers

When the order of memory accesses must be strictly enforced, software can use read/write barrier instructions to force reads and writes to proceed in program order. Read/write barrier instructions force all prior reads or writes to complete before subsequent reads or writes are executed. The LFENCE,

SFENCE, and MFENCE instructions are provided as dedicated read, write, and read/write barrier instructions (respectively). Serializing instructions, I/O instructions, and locked instructions (including the implicitly locked XCHG instruction) can also be used as read/write barriers. Barrier instructions are useful for controlling ordering between differing memory types as well as within one memory type; see section 7.3.1 for details.

Table 7-1 on page 173 summarizes the memory-access ordering possible for each memory type supported by the AMD64 architecture.

## 7.2 Multiprocessor Memory Access Ordering

The term memory ordering refers to the sequence in which memory accesses are performed by the memory system, as observed by all processors or programs.

To improve performance of applications, AMD64 processors can speculatively execute instructions out of program order and temporarily hold out-of-order results. However, certain rules are followed with regard to normal cacheable accesses on naturally aligned boundaries to WB memory.

In the examples below, all memory values are initialized to zero.

From the point of view of a program, in ascending order of priority:

- All loads, stores and I/O operations from a single processor appear to occur in program order to the code running on that processor and all instructions appear to execute in program order.
- Successive stores from a single processor are committed to system memory and visible to other processors in program order. A store by a processor cannot be committed to memory before a read appearing earlier in the program has captured its targeted data from memory. In other words, stores from a processor cannot be reordered to occur prior to a load preceding it in program order.

In this context:

- Loads do not pass previous loads (loads are not reordered). Stores do not pass previous stores (stores are not reordered)

Processor 0	Processor 1
Store A ← 1	Load B
Store B ← 1	Load A

Load A cannot read 0 when Load B reads 1. (This rule may be violated in the case of loads as part of a string operation, in which one iteration of the string reads 0 for Load A while another iteration reads 1 for Load B.)

- Stores do not pass loads

Processor 0	Processor 1
Load A	Load B
Store B ← 1	Store A ← 1

Load A and Load B cannot both read 1.

- Stores from a processor appear to be committed to the memory system in program order; however, stores can be delayed arbitrarily by store buffering while the processor continues operation. Therefore, stores from a processor may not appear to be sequentially consistent.

<b>Processor 0</b>	<b>Processor 1</b>
Store A ← 1	Store B ← 1
...	...
Store A ← 2	Store B ← 2
...	...
Load B	Load A

Both Load A and Load B may read 1. Also, due to possible write combining one or both processors may not actually store a 1 at the designated location.

- Non-overlapping Loads may pass stores.

<b>Processor 0</b>	<b>Processor 1</b>
Store A ← 1	Store B ← 1
Load B	Load A

All combinations of values (00, 01, 10, and 11) may be observed by Processors 0 and 1.

- Where sequential consistency is needed (for example in Dekker's algorithm for mutual exclusion), an MFENCE instruction should be used between the store and the subsequent load, or a locked access, such as XCHG, should be used for the store.

<b>Processor 0</b>	<b>Processor 1</b>
Store A ← 1	Store B ← 1
MFENCE	MFENCE
Load B	Load A

Load A and Load B cannot both read 0.

- Loads that partially overlap prior stores may return the modified part of the load operand from the store buffer, combining globally visible bytes with bytes that are only locally visible. To ensure that such loads return only a globally visible value, an MFENCE or locked access must be used between the store and the dependent load, or the store or load must be performed with a locked operation such as XCHG.
- Stores to different locations in memory observed from two (or more) other processors will appear in the same order to all observers. Behavior such as that shown in this code example,

<b>Processor 0</b>	<b>Processor 1</b>	<b>Processor X</b>	<b>Processor Y</b>
Store A ← 1	Store B ← 1		
		Load A (1)	Load B (1)
		Load B (0)	Load A (0)

in which processor X sees store A from processor 0 before store B from processor 1, while processor Y sees store B from processor 1 before store A from processor 0, is not allowed.

- Dependent stores between different processors appear to occur in program order, as shown in the code example below.

Processor 0	Processor 1	Processor 2
Store A ← 1		
	Load A (1)	
	Store B ← 1	
		Load B (1)
		Load A (1)

If processor 1 reads a value from A (written by processor 0) before carrying out a store to B, and if processor 2 reads the updated value from B, a subsequent read of A must also be the updated value.

- The local visibility (within a processor) for a memory operation may differ from the global visibility (from another processor). Using a data bypass, a local load can read the result of a local store in a store buffer, before the store becomes globally visible. Program order is still maintained when using such bypasses.

Processor 0	Processor 1
Store A ← 1	Store B ← 1
Load r1 A	Load r3 B
Load r2 B	Load r4 A

Load A in processor 0 can read 1 using the data bypass, while Load A in processor 1 can read 0. Similarly, Load B in processor 1 can read 1 while Load B in processor 0 can read 0. Therefore, the result  $r1 = 1$ ,  $r2 = 0$ ,  $r3 = 1$  and  $r4 = 0$  may occur. There are no constraints on the relative order of when the Store A of processor 0 is visible to processor 1 relative to when the Store B of processor 1 is visible to processor 0.

If a very strong memory ordering model is required that does not allow local store-load bypasses, an MFENCE instruction or a synchronizing instruction such as XCHG or a locked Read-modify-write should be used between the store and the subsequent load. This enforces a memory ordering stronger than total store ordering.

Processor 0	Processor 1
Store A ← 1	Store B ← 1
MFENCE	MFENCE
Load r1 A	Load r3 B
Load r2 B	Load r4 A

In this example, the MFENCE instruction ensures that any buffered stores are globally visible before the loads are allowed to execute, so the result  $r1 = 1$ ,  $r2 = 0$ ,  $r3 = 1$  and  $r4 = 0$  will not occur.



## 7.3 Memory Coherency and Protocol

Implementations that support caching support a cache-coherency protocol for maintaining coherency between main memory and the caches. The cache-coherency protocol is also used to maintain coherency between all processors in a multiprocessor system. The cache-coherency protocol supported by the AMD64 architecture is the *MOESI* (modified, owned, exclusive, shared, invalid) protocol. The states of the MOESI protocol are:

- *Invalid*—A cache line in the invalid state does not hold a valid copy of the data. Valid copies of the data can be either in main memory or another processor cache.
- *Exclusive*—A cache line in the exclusive state holds the most recent, correct copy of the data. The copy in main memory is also the most recent, correct copy of the data. No other processor holds a copy of the data.
- *Shared*—A cache line in the shared state holds the most recent, correct copy of the data. Other processors in the system may hold copies of the data in the shared state, as well. If no other processor holds it in the *owned* state, then the copy in main memory is also the most recent.
- *Modified*—A cache line in the modified state holds the most recent, correct copy of the data. The copy in main memory is stale (incorrect), and no other processor holds a copy.
- *Owned*—A cache line in the owned state holds the most recent, correct copy of the data. The owned state is similar to the shared state in that other processors can hold a copy of the most recent, correct data. Unlike the shared state, however, the copy in main memory can be stale (incorrect). Only one processor can hold the data in the owned state—all other processors must hold the data in the shared state.

Figure 7-2 on page 170 shows the general MOESI state transitions possible with various types of memory accesses. This is a logical software view, not a hardware view, of how cache-line state transitions. Instruction-execution activity and external-bus transactions can both be used to modify the cache MOESI state in multiprocessing or multi-mastering systems.

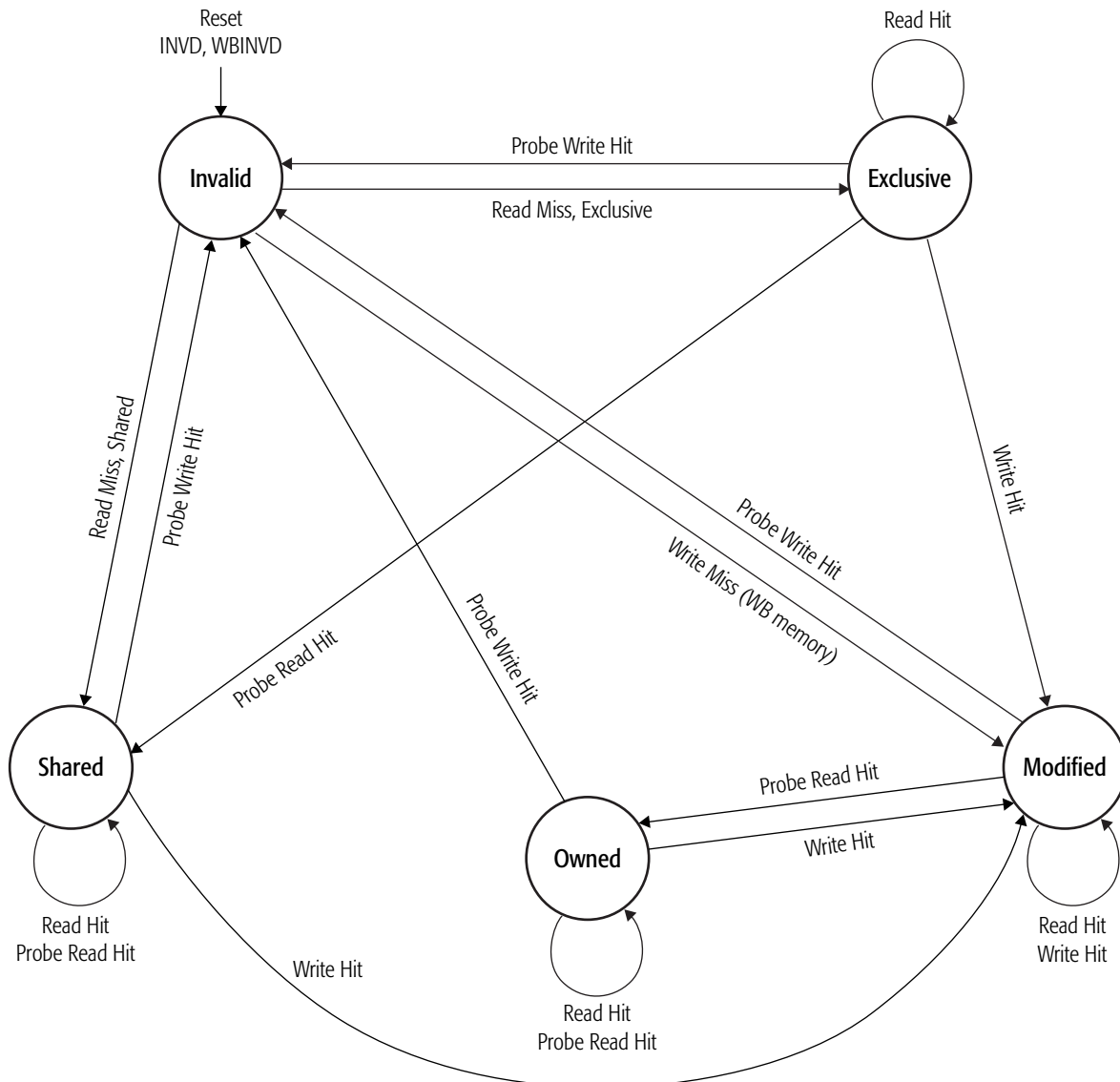

**Figure 7-2. MOESI State Transitions**

To maintain memory coherency, external bus masters (typically other processors with their own internal caches) need to acquire the most recent copy of data before caching it internally. That copy can be in main memory or in the internal caches of other bus-mastering devices. When an external master has a cache read-miss or write-miss, it *probes* the other mastering devices to determine whether the most recent copy of data is held in any of their caches. If one of the other mastering devices holds the most recent copy, it provides it to the requesting device. Otherwise, the most recent copy is provided by main memory.

There are two general types of bus-master probes:

- Read probes indicate the external master is requesting the data for read purposes.
- Write probes indicate the external master is requesting the data for the purpose of modifying it.

Referring back to Figure 7-2 on page 170, the state transitions involving probes are initiated by other processors and external bus masters into the processor. Some read probes are initiated by devices that intend to cache the data. Others, such as those initiated by I/O devices, do not intend to cache the data. Some processor implementations do not change the data MOESI state if the read probe is initiated by a device that does not intend to cache the data.

State transitions involving read misses and write misses can cause the processor to generate probes into external bus masters and to read main memory.

Read hits do not cause a MOESI-state change. Write hits generally cause a MOESI-state change into the modified state. If the cache line is already in the modified state, a write hit does not change its state.

The specific operation of external-bus signals and transactions and how they influence a cache MOESI state are implementation dependent. For example, an implementation could convert a write miss to a WB memory type into two separate MOESI-state changes. The first would be a read-miss placing the cache line in the exclusive state. This would be followed by a write hit into the exclusive cache line, changing the cache-line state to modified.

### 7.3.1 Special Coherency Considerations

In some cases, data can be modified in a manner that is impossible for the memory-coherency protocol to handle due to the effects of instruction prefetching. In such situations software must use serializing instructions and/or cache-invalidation instructions to guarantee subsequent data accesses are coherent.

An example of this type of a situation is a page-table update followed by accesses to the physical pages referenced by the updated page tables. The following sequence of events shows what can happen when software changes the translation of virtual-page *A* from physical-page *M* to physical-page *N*:

1. Software invalidates the TLB entry. The tables that translate virtual-page *A* to physical-page *M* are now held only in main memory. They are not cached by the TLB.
2. Software changes the page-table entry for virtual-page *A* in main memory to point to physical-page *N* rather than physical-page *M*.
3. Software accesses data in virtual-page *A*.

During Step 3, software expects the processor to access the data from physical-page *N*. However, it is possible for the processor to prefetch the data from physical-page *M* before the page table for virtual-page *A* is updated in Step 2. This is because the physical-memory references for the *page tables* are different than the physical-memory references for the *data*. Because the physical-memory references are different, the processor does not recognize them as requiring coherency checking and believes it is safe to prefetch the data from virtual-page *A*, which is translated into a read from physical page *M*. Similar behavior can occur when instructions are prefetched from beyond the page table update instruction.

To prevent this problem, software must use an INVLPG or MOV CR3 instruction immediately after the page-table update to ensure that subsequent instruction fetches and data accesses use the correct virtual-page-to-physical-page translation. It is not necessary to perform a TLB invalidation operation preceding the table update.

## 7.4 Memory Types

*Memory type* is an attribute that can be associated with a specific region of virtual or physical memory. Memory type designates certain caching and ordering behaviors for loads and stores to addresses in that region. Most memory types are explicitly assigned, although some are inferred by the hardware from current processor state and instruction context.

The AMD64 architecture defines the following memory types:

- *Uncacheable (UC)*—Reads from, and writes to, UC memory are not cacheable. Reads from UC memory cannot be speculative. Write-combining to UC memory is not allowed. Reads from or writes to UC memory cause the write buffers to be written to memory and be invalidated prior to the access to UC memory.

The UC memory type is useful for memory-mapped I/O devices where strict ordering of reads and writes is important.

- *Cache Disable (CD)*—The CD memory type is a form of uncacheable memory type that is inferred when the L1 caches are disabled but not invalidated, or for certain conflicting memory type assignments from the Page Attribute Table (PAT) and Memory Type Range Register (MTRR) mechanisms. The former case occurs when caches are disabled by setting CR0.CD to 1 without invalidating the caches with either the INVD or WBINVD instruction for any reference to a region designated as cacheable. The latter case occurs when a specific type has been assigned to a virtual page via PAT, and a conflicting type has been assigned to the mapped physical page via an MTRR (see “Combined Effect of MTRRs and PAT” on page 202 and “Combining Memory Types, MTRRs” on page 495 for details).

For the L1 data cache and the L2 cache, reads from, and writes to, CD memory that hit the cache, or any other caches in the system, cause the cache line(s) to be invalidated before accessing main memory. If a cache line is in the modified state, the line is written to main memory prior to being invalidated. The access is allowed to proceed after any invalidations are complete.

For the L1 instruction cache, instruction fetches from CD memory that hit the cache read the cached instructions rather than access main memory. Instruction fetches that miss the cache access main memory and do not cause cache-line replacement. Writes to CD memory that hit in the instruction cache cause the line to be invalidated.

- *Write-Combining (WC)*—Reads from, and writes to, WC memory are not cacheable. Reads from WC memory can be speculative.

Writes to this memory type can be combined internally by the processor and written to memory as a single write operation to reduce memory accesses. For example, four word writes to consecutive addresses can be combined by the processor into a single quadword write, resulting in one memory access instead of four.

The WC memory type is useful for graphics-display memory buffers where the order of writes is not important.

- *Write-Combining Plus (WC+)*—WC+ is an uncacheable memory type, and combines writes in write-combining buffers like WC. Unlike WC (but like the CD memory type), accesses to WC+ memory probe the caches on all processors (including the caches of the processor issuing the request) to maintain coherency. This ensures that cacheable writes are observed by WC+ accesses.
- *Write-Protect (WP)*—Reads from WP memory are cacheable and allocate cache lines on a read miss. Reads from WP memory can be speculative.

Writes to WP memory that hit in the cache do not update the cache. Instead, all writes update memory (write to memory), and writes that hit in the cache invalidate the cache line. Write buffering of WP memory is allowed.

The WP memory type is useful for shadowed-ROM memory where updates must be immediately visible to all devices that read the shadow locations.

- *Writethrough (WT)*—Reads from WT memory are cacheable and allocate cache lines on a read miss. Reads from WT memory can be speculative.

All writes to WT memory update main memory, and writes that hit in the cache update the cache line (cache lines remain in the same state after a write that hits a cache line). Writes that miss the cache do not allocate a cache line. Write buffering of WT memory is allowed.

- *Writeback (WB)*—Reads from WB memory are cacheable and allocate cache lines on a read miss. Cache lines can be allocated in the shared, exclusive, or modified states. Reads from WB memory can be speculative.

All writes that hit in the cache update the cache line and place the cache line in the modified state. Writes that miss the cache allocate a new cache line and place the cache line in the modified state. Writes to main memory only take place during writeback operations. Write buffering of WB memory is allowed.

The WB memory type provides the highest-possible performance and is useful for most software and data stored in system memory (DRAM).

Table 7-1 shows the memory access ordering possible for each memory type supported by the AMD64 architecture. Table 7-3 on page 176 shows the ordering behavior of various operations on various memory types in greater detail. Table 7-2 on page 175 shows the caching policy for the same memory types.

**Table 7-1. Memory Access by Memory Type**

Memory Access Allowed		Memory Type				
		UC/CD	WC	WP	WT	WB
Read	Out-of-Order	no	yes	yes	yes	yes
	Speculative	no	yes	yes	yes	yes
	Reorder Before Write	no	yes	yes	yes	yes
<b>Note:</b>						
1. Write-combining buffers are separate from write buffers.						

Table 7-1. Memory Access by Memory Type (continued)

Memory Access Allowed		Memory Type				
		UC/CD	WC	WP	WT	WB
Write	Out-of-Order	no	yes	no	no	no
	Speculative	no	no	no	no	no
	Buffering	no	yes	yes	yes	yes
	Combining <sup>1</sup>	no	yes	no	yes	yes

**Note:**

1. Write-combining buffers are separate from write buffers.

**Table 7-2. Caching Policy by Memory Type**

Caching Policy	Memory Type					
	UC	CD	WC	WP	WT	WB
Read Cacheable	no	no	no	yes	yes	yes
Write Cacheable	no	no	no	no	yes	yes
Read Allocate	no	no	no	yes	yes	yes
Write Allocate	no	no	no	no	no	yes
Write Hits Update Memory	yes <sup>2</sup>	yes <sup>1</sup>	yes <sup>2</sup>	yes <sup>3</sup>	yes	no

**Note:**

1. For the L1 data cache and the L2 cache, if an access hits the cache, the cache line is invalidated. If the cache line is in the modified state, the line is written to main memory and then invalidated. For the L1 instruction cache, read (instruction fetch) hits access the cache rather than main memory.
2. The data is not cached, so a cache write hit cannot occur. However, memory is updated.
3. Write hits update memory and invalidate the cache line.

#### 7.4.1 Memory Barrier Interaction with Memory Types

Memory types other than WB may allow weaker ordering in certain respects. When the ordering of memory accesses to differing memory types must be strictly enforced, software can use the LFENCE, MFENCE or SFENCE barrier instructions to force loads and stores to proceed in program order. Table 7-3 on page 176 summarizes the cases where a memory barrier must be inserted between two memory operations.

The table is read as follows: the ROW is the first memory operation in program order, followed by the COLUMN, which is the second memory operation in program order. Each cell represents the ordered combination of the two memory operations and the letters *a, b, c, d, e, f, g, h, i, j, k,* and *l* within the cell represent the applicable memory ordering rule for that combination. These symbols are described in the footnotes below the table. In the table and footnotes, the abbreviation *nt* stands for non-temporal (load or store), *io* stands for input / output, *lf* for LFENCE, *sf* for SFENCE, and *mf* for MFENCE.

**Table 7-3. Memory Access Ordering Rules**

First Memory Operation	Second Memory Operation								
	Load (wp, wt, wb)	Load (uc)	Load (wc, wc+)	Store (wp, wt, wb)	Store (uc)	Store (wc, wc+, non-temporal)	Load/Store (io)	Lock (atomic)	Serialize instructions/Interrupts/Exceptions
Load (wp, wt, wb)	a	f	b (lf)	c	c	c	d	d	d
Load (uc)	a	f	b (lf)	c	c	c	d	d	d
Load (wc, wc+)	a	f	b (lf)	c	c	c	d	d	d
Store (wp, wt, wb)	e (mf)	f	e (mf)	g	g	h (sf)	d	d	d
Store (uc)	i	f	i	g	g	h (sf)	d	d	d
Store (wc, wc+, non-temporal)	e (mf)	f	e (mf)	j (sf)	g, m	h (sf)	d	d	d
Load/Store (io)	k	k	k	k	k	l	d, k	d, k	d, k
Lock (atomic)	k	k	k	k	k	k	d, k	d, k	d, k
Serialize instruction/Interrupts/Exceptions	l	l	l	l	l	l	d, l	d, l	d, l

- a — A load (wp, wt, wb, wc, wc+) may pass a previous non-conflicting store (wp, wt, wb, wc, wc+, nt).
- b — A load (wc, wc+) may pass a previous load (wp, wt, wb, wc, wc+). To ensure memory order, an LFENCE instruction must be inserted between the two loads.
- c — A store (wp, wt, wb, uc, wc, wc+, nt) may not pass a previous load (wp, wt, wb, uc, wc, wc+, nt).
- d — All previous loads and stores complete to memory or I/O space before a memory access for an I/O, locked or serializing instruction is issued.
- e — A load (wp, wt, wb, wc, wc+) may pass a previous non-conflicting store (wp, wt, wb, wc, wc+, nt). To ensure memory order, an MFENCE instruction must be inserted between the store and the load.
- f — A load or store (uc) does not pass a previous load or store (wp, wt, wb, uc, wc, wc+, nt).
- g — A store (wp, wt, wb, uc) does not pass a previous store (wp, wt, wb, uc).
- h — A store (wc, wc+, nt) may pass a previous store (wp, wt, wb) or non-conflicting store (wc, wc+, nt). To ensure memory order, an SFENCE instruction must be inserted between these two stores. A store (wc, wc+, nt) does not pass a previous conflicting store (wc, wc+, nt).
- i — A load (wp, wt, wb, wc, wc+) does not pass a previous store (uc).
- j — A store (wp, wt, wb) may pass a previous store (wc, wc+, nt). To ensure memory order, an SFENCE instruction must be inserted between these two stores.
- k — All loads and stores associated with the I/O and locked instructions complete to memory (no buffered stores) before a load or store from a subsequent instruction is issued.
- l — All loads and stores complete to memory for the serializing instruction before the subsequent instruction fetch is issued.



m — A store (uc) does not pass a previous store (wc, wc+).

## 7.5 Buffering and Combining Memory Writes

### 7.5.1 Write Buffering

Writes to memory (main memory and caches) can be stored internally by the processor in *write buffers* (also known as store buffers) before actually writing the data into a memory location. System performance can be improved by buffering writes, as shown in the following examples:

- When higher-priority memory transactions, such as reads, compete for memory access with writes, writes can be delayed in favor of reads, which minimizes or eliminates an instruction-execution stall due to a memory-operand read.
- When the memory is busy, buffering writes while the memory is busy removes the writes from the instruction-execution pipeline, which frees instruction-execution resources.

The processor manages the write buffer so that it is transparent to software. Memory accesses check the write buffer, and the processor completes writes into memory from the buffer in program order. Also, the processor completely empties the write buffer by writing the contents to memory as a result of performing any of the following operations:

- *SFENCE Instruction*—Executing a store-fence (SFENCE) instruction forces all memory writes before the SFENCE (in program order) to be written into memory (or, for WB type, the cache) before memory writes that follow the SFENCE instruction. The memory-fence (MFENCE) instruction has a similar effect, but it forces the ordering of loads in addition to stores.
- *Serializing Instructions*—Executing a serializing instruction forces the processor to retire the serializing instruction (complete both instruction execution and result writeback) before the next instruction is fetched from memory.
- *I/O instructions*—Before completing an I/O instruction, all previous reads and writes must be written to memory, and the I/O instruction must complete before completing subsequent reads or writes. Writes to I/O-address space (OUT instruction) are never buffered.
- *Locked Instructions*—A locked instruction (an instruction executed using the LOCK prefix) or an XCHG instruction (which is implicitly locked) must complete *after* all previous reads and writes and *before* subsequent reads and writes. Locked writes are never buffered, although locked reads and writes are cacheable.
- *Interrupts and Exceptions*—Interrupts and exceptions are serializing events that force the processor to write all results from the write buffer to memory before fetching the first instruction from the interrupt or exception service routine.
- *UC Memory Reads*—UC memory reads are not reordered ahead of writes.

Write buffers can behave similarly to *write-combining buffers* because multiple writes may be collected internally before transferring the data to caches or main memory. See the following section for a description of write combining.

## 7.5.2 Write Combining

Write-combining memory uses a different buffering scheme than write buffering described above. Writes to write-combining (WC) memory can be combined internally by the processor in a buffer for more efficient transfer to main memory at a later time. For example, 16 doubleword writes to consecutive memory addresses can be combined in the WC buffers and transferred to main memory as a single burst operation rather than as individual memory writes.

The following instructions perform writes to WC memory:

- (V)MASKMOVDQU
- MASKMOVQ
- (V)MOVNTDQ
- MOVNTI
- (V)MOVNTPD
- (V)MOVNTPS
- MOVNTQ
- MOVNTSD
- MOVNTSS

WC memory is not cacheable. A WC buffer writes its contents only to main memory.

The size and number of WC buffers available is implementation dependent. The processor assigns an address range to an empty WC buffer when a WC-memory write occurs. The size and alignment of this address range is equal to the buffer size. All subsequent writes to WC memory that fall within this address range can be stored by the processor in the WC-buffer entry until an event occurs that causes the processor to write the WC buffer to main memory. After the WC buffer is written to main memory, the processor can assign a new address range on a subsequent WC-memory write.

Writes to consecutive addresses in WC memory are not required for the processor to combine them. The processor combines any WC memory write that falls within the active-address range for a buffer. Multiple writes to the same address overwrite each other (in program order) until the WC buffer is written to main memory.

It is possible for writes to proceed out of program order when WC memory is used. For example, a write to cacheable memory that follows a write to WC memory can be written into the cache before the WC buffer is written to main memory. For this reason, and the reasons listed in the previous paragraph, software that is sensitive to the order of memory writes should avoid using WC memory.

WC buffers are written to main memory under the same conditions as the write buffers, namely when:

- Executing a store-fence (SFENCE) instruction.
- Executing a serializing instruction.
- Executing an I/O instruction.
- Executing a locked instruction (an instruction executed using the LOCK prefix).

- Executing an XCHG instruction
- An interrupt or exception occurs.

WC buffers are also written to main memory when:

- A subsequent non-write-combining operation has a write address that matches the WC-buffer active-address range.
- A write to WC memory falls outside the WC-buffer active-address range. The existing buffer contents are written to main memory, and a new address range is established for the latest WC write.

## 7.6 Memory Caches

The AMD64 architecture supports the use of internal and external caches. The size, organization, coherency mechanism, and replacement algorithm for each cache is implementation dependent. Generally, the existence of the caches is transparent to both application and system software. In some cases, however, software can use cache-structure information to optimize memory accesses or manage memory coherency. Such software can use the extended-feature functions of the CPUID instruction to gather information on the caching subsystem supported by the processor. For more information, see Section 3.3, “Processor Feature Identification,” on page 63.

### 7.6.1 Cache Organization and Operation

Although the detailed organization of a processor cache depends on the implementation, the general constructs are similar. L1 caches—data and instruction, or unified—and L2 caches usually are implemented as n-way set-associative caches. Figure 7-3 on page 180 shows a typical *logical* organization of an n-way set-associative cache. The physical implementation of the cache can be quite different.

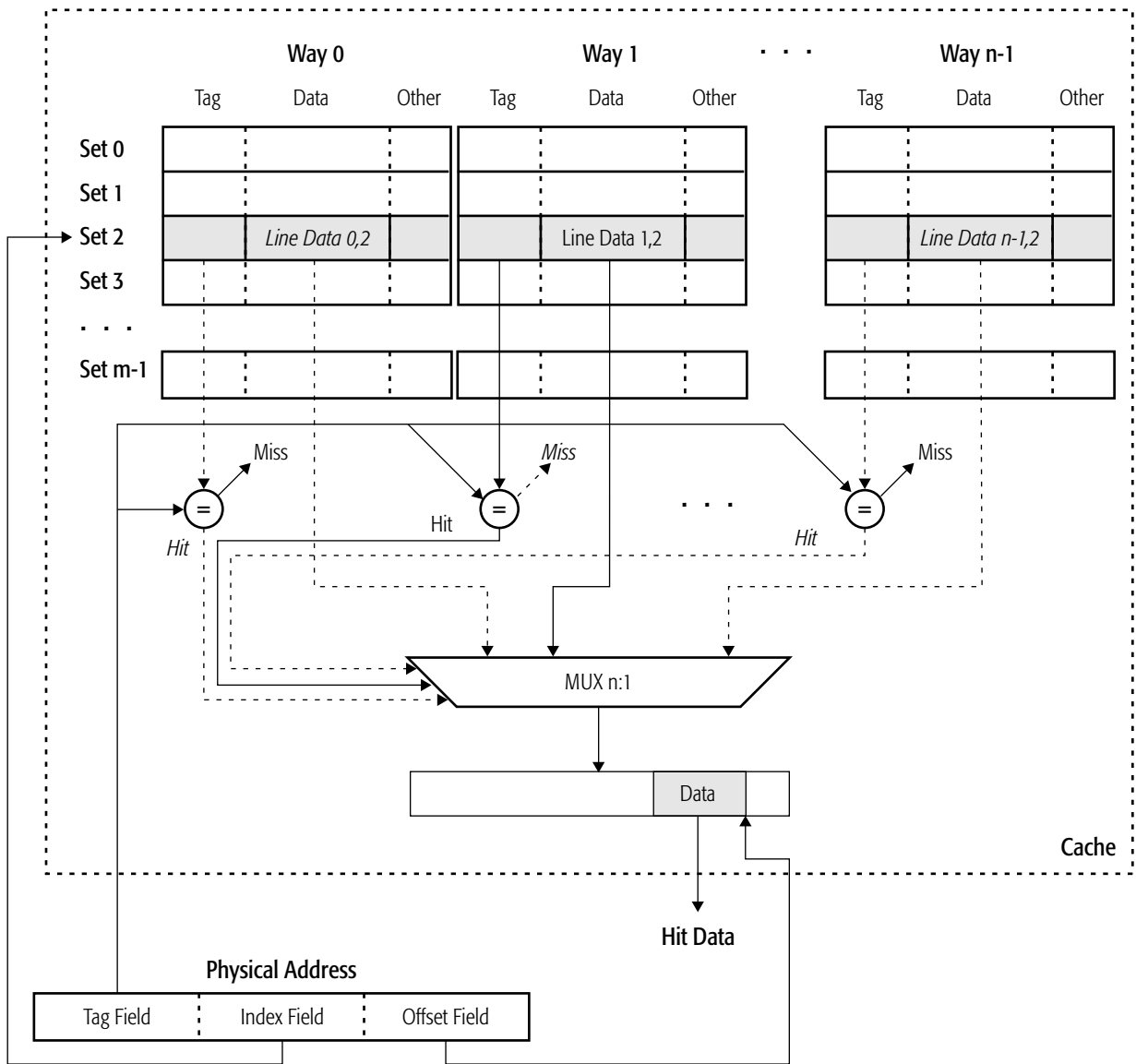

**Figure 7-3. Cache Organization Example**

As shown in Figure 7-3, the cache is organized as an array of cache lines. Each cache line consists of three parts: a cache-data line (a fixed-size copy of a memory block), a tag, and other information. Rows of cache lines in the cache array are *sets*, and columns of cache lines are *ways*. In an n-way set-associative cache, each set is a collection of n lines. For example, in a four-way set-associative cache, each set is a collection of four cache lines, one from each way.

The cache is accessed using the physical address of the data or instruction being referenced. To access data within a cache line, the physical address is used to select the set, way, and byte from the cache. This is accomplished by dividing the physical address into the following three fields:

- *Index*—The *index field* selects the cache set (row) to be examined for a hit. All cache lines within the set (one from each way) are selected by the index field.
- *Tag*—The *tag field* is used to select a specific cache line from the cache set. The physical-address tag field is compared with each cache-line tag in the set. If a match is found, a cache hit is signalled, and the appropriate cache line is selected from the set. If a match is not found, a cache miss is signalled.
- *Offset*—The *offset field* points to the first byte in the cache line corresponding to the memory reference. The referenced data or instruction value is read from (or written to, in the case of memory writes) the selected cache line starting at the location selected by the offset field.

In Figure 7-3 on page 180, the physical-address index field is shown selecting Set 2 from the cache. The tag entry for each cache line in the set is compared with the physical-address tag field. The tag entry for Way 1 matches the physical-address tag field, so the cache-line data for Set 2, Way 1 is selected using the n:1 multiplexor. Finally, the physical-address offset field is used to point to the first byte of the referenced data (or instruction) in the selected cache line.

Cache lines can contain other information in addition to the data and tags, as shown in Figure 7-3 on page 180. MOESI state and the state bits associated with the cache-replacement algorithm are typical pieces of information kept with the cache line. Instruction caches can also contain pre-decode or branch-prediction information. The type of information stored with the cache line is implementation dependent.

**Self-Modifying Code.** Software that writes into the code segment from which it was fetched is classified as self-modifying code. To avoid cache-coherency problems due to self-modifying code, a check is made during data writes to see whether the data-memory location corresponds to a code-segment memory location. If it does, implementations of the AMD64 architecture invalidate the corresponding *instruction-cache* line(s) during the data-memory write. Entries in the data cache are not invalidated, and it is possible for the modified instruction to be cached by the data cache following the memory write. A subsequent fetch of the modified instruction goes to main memory to get the coherent version of the instruction. If the data cache holds the most recent copy of the instruction rather than main memory, it provides that copy.

The processor determines whether a write is in a code segment by internally probing the instruction cache and prefetched instructions. If the internal probe returns a hit, the instruction-cache line and prefetched instructions are invalidated. The internal probes into the instruction cache and prefetch hardware are always performed using the *physical address* of an instruction in order to avoid potential aliasing problems associated with using virtual (linear) addresses.

**Cross-Modifying Code.** Software that stores into an instruction stream which may be running simultaneously on another processor, with the intent that the other processor execute the modified instruction stream, is classified as cross-modifying code.

There are two cases to consider: one where the modification may be done asynchronously with respect to the target thread and one where explicit synchronization is required between the two threads.

If the region to be modified is contained within a naturally-aligned quadword and is updated using a single atomic store, the timing of the modification is not significant; no special synchronization is needed between the processors. Examples of this would be changing the 4-byte displacement field of a jump instruction or changing a NOP to an INT3 instruction.

If the modification does not meet these criteria, explicit producer/consumer synchronization is required for predictable operation. In this case, the target thread must wait on a signal from the modifying thread, such as the state of a flag in a shared variable. The modifying thread writes the instruction bytes in any desired manner, then sets the flag to release the target thread. The target thread must execute a serializing instruction such as an MFENCE after seeing the signal from the modifying thread before executing the modified code.

See Volume 1, Chapter 3, “Semaphores,” for a discussion of instructions that are useful for interprocessor synchronization.

## 7.6.2 Cache Control Mechanisms

The AMD64 architecture provides a number of mechanisms for controlling the cacheability of memory. These are described in the following sections.

**Cache Disable.** Bit 30 of the CR0 register is the cache-disable bit, CR0.CD. Caching is enabled when CR0.CD is cleared to 0, and caching is disabled when CR0.CD is set to 1. When caching is disabled, reads and writes access main memory.

Software can disable the cache while the cache still holds valid data (or instructions). If a read or write hits the L1 data cache or the L2 cache when CR0.CD=1, the processor does the following:

1. Writes the cache line back if it is in the modified or owned state.
2. Invalidates the cache line.
3. Performs a non-cacheable main-memory access to read or write the data.

If an instruction fetch hits the L1 instruction cache when CR0.CD=1, the processor reads the cached instructions rather than access main memory.

The processor also responds to cache probes when CR0.CD=1. Probes that hit the cache cause the processor to perform Step 1. Step 2 (cache-line invalidation) is performed only if the probe is performed on behalf of a memory write or an exclusive read.

**Writethrough Disable.** Bit 29 of the CR0 register is the *not writethrough* disable bit, CR0.NW. In early x86 processors, CR0.NW is used to control cache writethrough behavior, and the combination of CR0.NW and CR0.CD determines the cache operating mode.

*In early x86 processors*, clearing CR0.NW to 0 enables writeback caching for main memory, effectively disabling writethrough caching for main memory. When CR0.NW=0, software can disable

writeback caching for specific memory pages or regions by using other cache control mechanisms. When software sets CR0.NW to 1, writeback caching is disabled for main memory, while writethrough caching is enabled.

*In implementations of the AMD64 architecture, CR0.NW is not used to qualify the cache operating mode established by CR0.CD. Table 7-4 shows the effects of CR0.NW and CR0.CD on the AMD64 architecture cache-operating modes.*

**Table 7-4. AMD64 Architecture Cache-Operating Modes**

CR0.CD	CR0.NW	Cache Operating Mode
0	0	Cache enabled with a writeback-caching policy.
0	1	Invalid setting—causes a general-protection exception (#GP).
1	0	Cache disabled. See “Cache Disable” on page 182.
1	1	

**Page-Level Cache Disable.** Bit 4 of all paging data-structure entries controls page-level cache disable (PCD). When a data-structure-entry PCD bit is cleared to 0, the page table or physical page pointed to by that entry is cacheable, as determined by the CR0.CD bit. When the PCD bit is set to 1, the page table or physical page is not cacheable. The PCD bit in the paging data-structure base-register (bit 4 in CR3) controls the cacheability of the highest-level page table in the page-translation hierarchy.

**Page-Level Writethrough Enable.** Bit 3 of all paging data-structure entries is the page-level writethrough enable control (PWT). When a data-structure-entry PWT bit is cleared to 0, the page table or physical page pointed to by that entry has a writeback caching policy. When the PWT bit is set to 1, the page table or physical page has a writethrough caching policy. The PWT bit in the paging data-structure base-register (bit 3 in CR3) controls the caching policy of the highest-level page table in the page-translation hierarchy.

The corresponding PCD bit must be cleared to 0 (page caching enabled) for the PWT bit to have an effect.

**Memory Typing.** Two mechanisms are provided for software to control access to and cacheability of specific memory regions:

- The memory-type range registers (MTRRs) control cacheability based on physical addresses. See “MTRRs” on page 189 for more information on the use of MTRRs.
- The page-attribute table (PAT) mechanism controls cacheability based on virtual addresses. PAT extends the capabilities provided by the PCD and PWT page-level cache controls. See “Page-Attribute Table Mechanism” on page 199 for more information on the use of the PAT mechanism.

System software can combine the use of both the MTRRs and PAT mechanisms to maximize control over memory cacheability.

If the MTRRs are disabled in implementations that support the MTRR mechanism, the default memory type is set to uncacheable (UC). Memory accesses are not cached even if the caches are enabled by clearing CR0.CD to 0. Cacheable memory types must be established using the MTRRs in order for memory accesses to be cached.

**Cache Control Precedence.** The cache-control mechanisms are used to define the memory type and cacheability of main memory and regions of main memory. Taken together, the most restrictive memory type takes precedence in defining the caching policy of memory. The order of precedence is:

1. Uncacheable (UC)
2. Write-combining (WC)
3. Write-protected (WP)
4. Writethrough (WT)
5. Writeback (WB)

For example, assume a large memory region is designated a writethrough type using the MTRRs. Individual pages within that region can have caching disabled by setting the appropriate page-table PCD bits. However, no pages within that region can have a writeback caching policy, regardless of the page-table PWT values.

### 7.6.3 Cache and Memory Management Instructions

**Data Prefetch.** The prefetch instructions are used by software as a hint to the processor that the referenced data is likely to be used in the near future. The processor can preload the cache line containing the data in anticipation of its use. `PREFETCH` provides a hint that the data is to be read. `PREFETCHW` provides a hint that the data is to be written. The processor can mark the line as modified if it is preloaded using `PREFETCHW`.

**Memory Ordering.** Instructions are provided for software to enforce memory ordering (serialization) in weakly-ordered memory types. These instructions are:

- *SFENCE* (*store fence*)—forces all memory writes (stores) preceding the `SFENCE` (in program order) to be written into memory before memory writes following the `SFENCE`.
- *LFENCE* (*load fence*)—forces all memory reads (loads) preceding the `LFENCE` (in program order) to be read from memory before memory reads following the `LFENCE`.
- *MFENCE* (*memory fence*)—forces all memory accesses (reads and writes) preceding the `MFENCE` (in program order) to be written into or read from memory before memory accesses following the `MFENCE`.

**Cache Line Flush.** The `CLFLUSH` instruction (writeback, if modified, and invalidate) takes the byte memory-address operand (a linear address), and checks to see if the address is cached. If the address is cached, the entire cache line containing the address is invalidated. If any portion of the cache line is dirty (in the modified or owned state), the entire line is written to main memory before it is invalidated.



CLFLUSH affects *all caches* in the memory hierarchy—internal and external to the processor. The checking and invalidation process continues until the address has been invalidated in all caches.

In most cases, the underlying memory type assigned to the address has no effect on the behavior of this instruction. However, when the underlying memory type for the address is UC or WC (as defined by the MTRRs), the processor does not proceed with checking all caches to see if the address is cached. In both cases, the address is uncacheable, and invalidation is unnecessary. Write-combining buffers are written back to memory if the corresponding physical address falls within the buffer active-address range.

**Cache Writeback and Invalidate.** Unlike the CLFLUSH instruction, the WBINVD instruction operates on the entire cache, rather than a single cache line. The WBINVD instruction first writes back all cache lines that are dirty (in the modified or owned state) to main memory. After writeback is complete, the instruction invalidates all cache lines. The checking and invalidation process continues until all internal caches are invalidated. A special bus cycle is transmitted to higher-level external caches directing them to perform a writeback-and-invalidate operation.

**Cache Invalidate.** The INVD instruction is used to invalidate all cache lines. Unlike the WBINVD instruction, dirty cache lines are not written to main memory. The process continues until all internal caches have been invalidated. A special bus cycle is transmitted to higher-level external caches directing them to perform an invalidation.

The INVD instruction should only be used in situations where memory coherency is not required.

#### 7.6.4 Serializing Instructions

Serializing instructions force the processor to retire the serializing instruction and all previous instructions before the next instruction is fetched. A serializing instruction is retired when the following operations are complete:

- The instruction has executed.
- All registers modified by the instruction are updated.
- All memory updates performed by the instruction are complete.
- All data held in the write buffers have been written to memory.

Serializing instructions can be used as a barrier between memory accesses to force strong ordering of memory operations. Care should be exercised in using serializing instructions because they modify processor state and affect program flow. The instructions also force execution serialization, which can significantly degrade performance. When strongly-ordered memory accesses are required, but execution serialization is not, it is recommended that software use the memory-ordering instructions described on page 184.

The following are serializing instructions:

- *Non-Privileged Instructions*
  - CPUID

- IRET
- RSM
- MFENCE
- *Privileged Instructions*
  - MOV CR<sub>n</sub>
  - MOV DR<sub>n</sub>
  - LGDT, LIDT, LLDT, LTR
  - SWAPGS
  - WRMSR
  - WBINVD, INVD
  - INVLPG

### 7.6.5 Cache and Processor Topology

Cache and processor topology information is useful in the optimal management of system and application resources. Exposing processor and cache topology information to the programmer allows software to make more efficient use of hardware multithreading resources delivering optimal performance. Shared resources in a specific cache and processor topology may require special consideration in the optimization of multiprocessing software performance.

The processor topology allows software to determine which cores are siblings in a compute unit, node, and processor package. For example, a scheduler can then choose to either compact or scatter threads (or processes) to cores in compute units, nodes, or across the cores in the entire physical package in order to optimize for a power and performance profile.

Topology extensions define processor topology at both the node, compute unit and cache level. Topology extensions include cache properties with sharing and the processor topology identified. The result is a simplified extension to the CPUID instruction that describes the processors cache topology and leverages existing industry cache properties folded into AMD's topology extension description.

Topology extensions definition supports existing and future processors with varying degrees of cache level sharing. Topology extensions also support the description of a simple compute unit with one core or packages where the number of cores in a node and/or compute unit are not an even power of two.

**CPUID Function 8000\_001D: Cache Topology Definition.** CPUID Function 8000\_001D describes the hierarchical relationships of cache levels relative to the cores which share these resources. Function 8000\_001D is defined to be called iteratively with the value 8000001Dh in EAX and an additional parameter in ECX. To gather information for all cache levels, software must call CPUID with 8000001Dh in EAX and ECX set to increasing values beginning with 0 until a value of 0 is returned from EAX[4:0], which indicates no more cache descriptions.

If software dynamically manages cache configuration, it will need to update any stored cache properties for the processor.

**CPUID Function 8000\_001E: Processor Topology Definition.** CPUID Function 8000\_001E describes processor topology with component identifiers. To read the processor topology, definition software calls the CPUID instruction with the value 8000001Eh in EAX. After execution the APIC ID is represented in EAX. EBX contains the compute unit description in the processor, while ECX contains system unique node identification. Software may read this information once for each core.

The following CPUID functions provide information about processor topology:

- CPUID Fn8000\_0001\_ECX
- CPUID Fn8000\_0008\_ECX
- CPUID Fn8000\_001D\_EAX, EBX, ECX, EDX
- CPUID Fn8000\_001E\_EAX, EBX, ECX

For more information using the CPUID instruction, see Section 3.3, “Processor Feature Identification,” on page 63.

## 7.7 Memory-Type Range Registers

The AMD64 architecture supports three mechanisms for software access-control and cacheability-control over memory regions. These mechanisms can be used in place of similar capabilities provided by external chipsets used with early x86 processors.

This section describes a control mechanism that uses a set of programmable model-specific registers (MSRs) called the *memory-type-range registers* (MTRRs). The MTRR mechanism provides system software with the ability to manage hardware-device memory mapping. System software can characterize physical-memory regions by type (e.g., ROM, flash, memory-mapped I/O) and assign hardware devices to the appropriate physical-memory type.

Another control mechanism is implemented as an extension to the page-translation capability and is called the *page attribute table* (PAT). It is described in “Page-Attribute Table Mechanism” on page 199. Like the MTRRs, PAT provides system software with the ability to manage hardware-device memory mapping. With PAT, however, system software can characterize physical pages and assign virtually-mapped devices to those physical pages using the page-translation mechanism. PAT may be used in conjunction with the MTRR mechanism to maximize flexibility in memory control.

Finally, control mechanisms are provided for managing memory-mapped I/O. These mechanisms employ extensions to the MTRRs and a separate feature called the *top-of-memory registers*. The MTRR extensions include additional MTRR type-field encodings for fixed-range MTRRs and variable-range I/O range registers (IORRs). These mechanisms are described in “Memory-Mapped I/O” on page 203.

### 7.7.1 MTRR Type Fields

The MTRR mechanism provides a means for associating a physical-address range with a memory type (see “Memory Types” on page 172). The MTRRs contain a type field used to specify the memory type in effect for a given physical-address range.

There are two variants of the memory type-field encodings: standard and extended. Both the standard and extended encodings use type-field bits 2:0 to specify the memory type. For the standard encodings, bits 7:3 are reserved and must be zero. For the extended encodings, bits 7:5 are reserved, but bits 4:3 are defined as the RdMem and WrMem bits. “Extended Fixed-Range MTRR Type-Field Encodings” on page 204 describes the function of these extended bits and how software enables them. Only the fixed-range MTRRs support the extended type-field encodings. Variable-range MTRRs use the standard encodings.

Table 7-5 on page 189 shows the memory types supported by the MTRR mechanism and their encoding in the MTRR type fields referenced throughout this section. Unless the extended type-field encodings are explicitly enabled, the processor uses the type values shown in Table 7-5.

**Table 7-5. MTRR Type Field Encodings**

Type Value	Type Name	Type Description
00h	UC—Uncacheable	All accesses are uncacheable. Write combining is not allowed. Speculative accesses are not allowed
01h	WC—Write-Combining	All accesses are uncacheable. Write combining is allowed. Speculative reads are allowed
04h	WT—Writethrough	Reads allocate cache lines on a cache miss. Cache lines are not allocated on a write miss. Write hits update the cache and main memory.
05h	WP—Write-Protect	Reads allocate cache lines on a cache miss. All writes update main memory. Cache lines are not allocated on a write miss. Write hits invalidate the cache line and update main memory.
06h	WB—Writeback	Reads allocate cache lines on a cache miss, and can allocate to either the shared, exclusive, or modified state. Writes allocate to the modified state on a cache miss.

If the MTRRs are disabled in implementations that support the MTRR mechanism, the default memory type is set to uncacheable (UC). *Memory accesses are not cached even if the caches are enabled by clearing CR0.CD to 0.* Cacheable memory types must be established using the MTRRs to enable memory accesses to be cached.

### 7.7.2 MTRRs

Both fixed-size and variable-size address ranges are supported by the MTRR mechanism. The fixed-size ranges are restricted to the lower 1 Mbyte of physical-address space, while the variable-size ranges can be located anywhere in the physical-address space.

Figure 7-4 on page 190 shows an example mapping of physical memory using the fixed-size and variable-size MTRRs. The areas shaded gray are not mapped by the MTRRs. Unmapped areas are set to the software-selected default memory type.

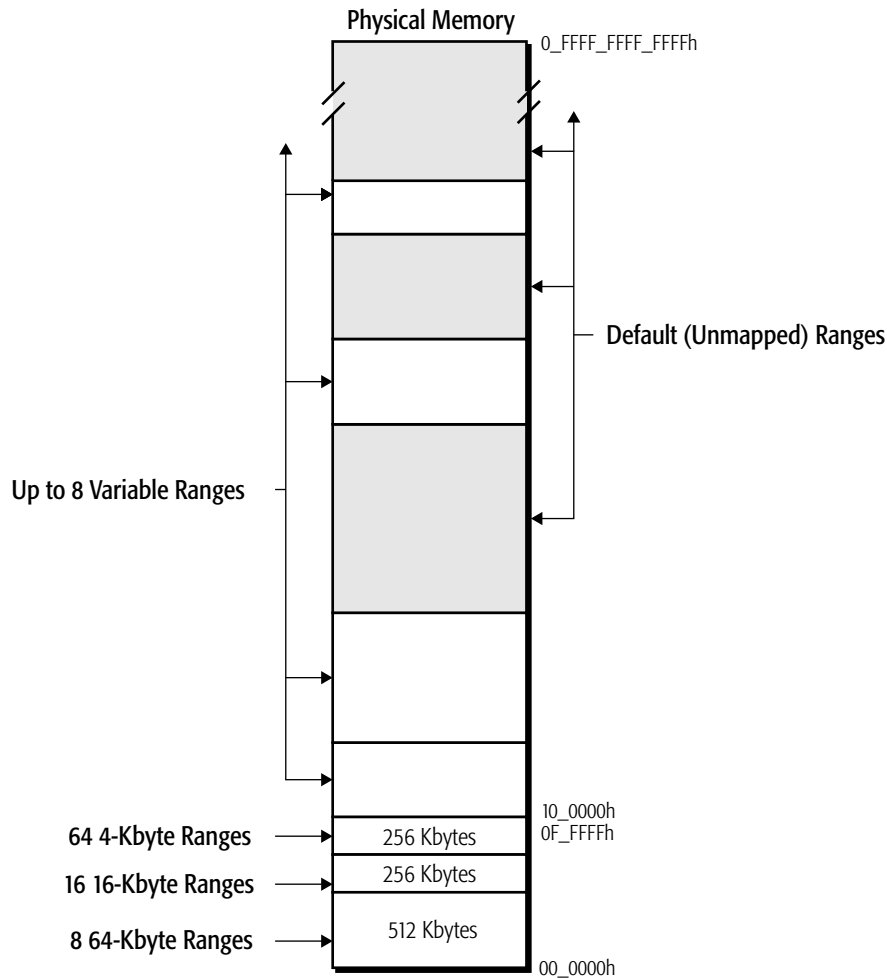

**Figure 7-4. MTRR Mapping of Physical Memory**

MTRRs are 64-bit model-specific registers (MSRs). They are read using the RDMSR instruction and written using the WRMSR instruction. See “Memory-Typing MSRs” on page 572 for a listing of the MTRR MSR numbers. The following sections describe the types of MTRRs and their function.

**Fixed-Range MTRRs.** The fixed-range MTRRs are used to characterize the first 1 Mbyte of physical memory. Each fixed-range MTRR contains eight type fields for characterizing a total of eight memory ranges. Fixed-range MTRRs support extended type-field encodings as described in “Extended Fixed-Range MTRR Type-Field Encodings” on page 204. The extended type field allows a fixed-range MTRR to be used as a fixed-range IORR. Figure 7-5 on page 191 shows the format of a fixed-range MTRR.

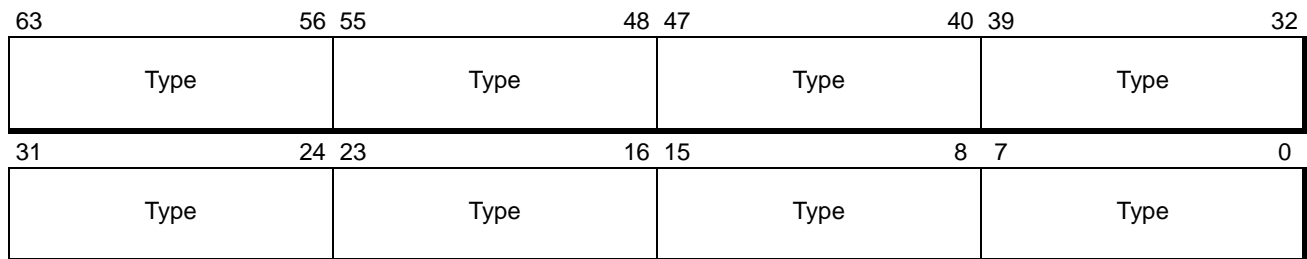

**Figure 7-5. Fixed-Range MTRR**

For the purposes of memory characterization, the first 1 Mbyte of physical memory is segmented into a total of 88 non-overlapping memory ranges, as follows:

- The 512 Kbytes of memory spanning addresses 00\_0000h to 07\_FFFFh are segmented into eight 64-Kbyte ranges. A single MTRR is used to characterize this address space.
- The 256 Kbytes of memory spanning addresses 08\_0000h to 0B\_FFFFh are segmented into 16 16-Kbyte ranges. Two MTRRs are used to characterize this address space.
- The 256 Kbytes of memory spanning addresses 0C\_0000h to 0F\_FFFFh are segmented into 64 4-Kbyte ranges. Eight MTRRs are used to characterize this address space.

Table 7-6 shows the address ranges corresponding to the type fields within each fixed-range MTRR. The gray-shaded heading boxes represent the bit ranges for each type field in a fixed-range MTRR. See Table 7-5 on page 189 for the type-field encodings.

**Table 7-6. Fixed-Range MTRR Address Ranges**

Physical Address Range (in hexadecimal)								Register Name
63–56	55–48	47–40	39–32	31–24	23–16	15–8	7–0	
7000–7FFFF	6000–6FFFF	50000–5FFFF	40000–4FFFF	30000–3FFFF	20000–2FFFF	10000–1FFFF	00000–0FFFF	MTRRfix64K_00000
9C000–9FFFF	98000–9BFFF	94000–97FFF	90000–93FFF	8C000–8FFFF	88000–8BFFF	84000–87FFF	80000–83FFF	MTRRfix16K_80000
BC000–BFFFF	B8000–BBFFF	B4000–B7FFF	B0000–B3FFF	AC000–AFFFF	A8000–ABFFF	A4000–A7FFF	A0000–A3FFF	MTRRfix16K_A0000
C7000–C7FFF	C6000–C6FFF	C5000–C5FFF	C4000–C4FFF	C3000–C3FFF	C2000–C2FFF	C1000–C1FFF	C0000–C0FFF	MTRRfix4K_C0000
CF000–CFFFF	CE000–CEFFF	CD000–CDFFF	CC000–CCFFF	CB000–CBFFF	CA000–CAFFF	C9000–C9FFF	C8000–C8FFF	MTRRfix4K_C8000
D7000–D7FFF	D6000–D6FFF	D5000–D5FFF	D4000–D4FFF	D3000–D3FFF	D2000–D2FFF	D1000–D1FFF	D0000–D0FFF	MTRRfix4K_D0000
DF000–DFFFF	DE000–DEFFF	DD000–DDFFF	DC000–DCFFF	DB000–DBFFF	DA000–DAFFF	D9000–D9FFF	D8000–D8FFF	MTRRfix4K_D8000
E7000–E7FFF	E6000–E6FFF	E5000–E5FFF	E4000–E4FFF	E3000–E3FFF	E2000–E2FFF	E1000–E1FFF	E0000–E0FFF	MTRRfix4K_E0000

Table 7-6. Fixed-Range MTRR Address Ranges (continued)

Physical Address Range (in hexadecimal)								Register Name
63–56	55–48	47–40	39–32	31–24	23–16	15–8	7–0	
EF000– EFFFF	EE000– EEFFF	ED000– EDFFF	EC000– ECFFF	EB000– EBFFF	EA000– EAFFF	E9000– E9FFF	E8000– E8FFF	MTRRfix4K_E8000
F7000– F7FFF	F6000– F6FFF	F5000– F5FFF	F4000– F4FFF	F3000– F3FFF	F2000– F2FFF	F1000– F1FFF	F0000– F0FFF	MTRRfix4K_F0000
FF000– FFFFFF	FE000– FEFFF	FD000– FDFFF	FC000– FCFFF	FB000– FBFFF	FA000– FAFFF	F9000– F9FFF	F8000– F8FFF	MTRRfix4K_F8000

**Variable-Range MTRRs.** The variable-range MTRRs can be used to characterize any address range within the physical-memory space, including all of physical memory. Up to eight address ranges of varying sizes can be characterized using the MTRR. Two variable-range MTRRs are used to characterize each address range: *MTRRphysBasen* and *MTRRphysMaskn* (*n* is the address-range number from 0 to 7). For example, address-range 3 is characterized using the *MTRRphysBase3* and *MTRRphysMask3* register pair.

Figure 7-6 shows the format of the *MTRRphysBasen* register and Figure 7-7 on page 193 shows the format of the *MTRRphysMaskn* register. The fields within the register pair are read/write.

**MTRRphysBasen Registers.** The fields in these variable-range MTRRs, shown in Figure 7-6, are:

- *Type*—Bits 7:0. The memory type used to characterize the memory range. See Table 7-5 on page 189 for the type-field encodings. Variable-range MTRRs do not support the extended type-field encodings.
- *Range Physical Base-Address (PhysBase)*—Bits 51:12. The memory-range base-address in physical-address space. *PhysBase* is aligned on a 4-Kbyte (or greater) address in the 52-bit physical-address space supported by the AMD64 architecture. *PhysBase* represents the most-significant 40-address bits of the physical address. Physical-address bits 11:0 are assumed to be 0.

Note that a given processor may implement less than the architecturally-defined physical address size of 52 bits.



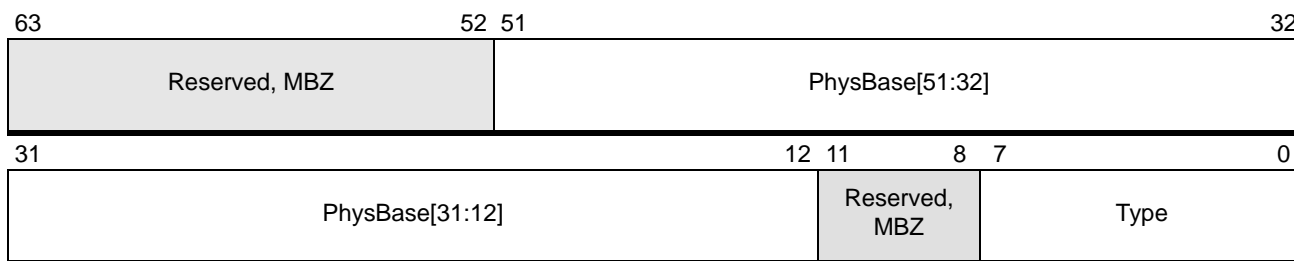

Bits	Mnemonic	Description	R/W
63:52	Reserved	Reserved, Must be Zero	
51:12	PhysBase	Range Physical Base Address	R/W
11:8	Reserved	Reserved, Must be Zero	
7:0	Type	Default Memory Type	R/W

**Figure 7-6. MTRRphysBasen Register**

**MTRRphysMaskn Registers.** The fields in these variable-range MTRRs, shown in Figure 7-7, are:

- *Valid (V)*—Bit 11. Indicates that the MTRR pair is valid (enabled) when set to 1. When the valid bit is cleared to 0 the register pair is not used.
- *Range Physical Mask (PhysMask)*—Bits 51:12. The mask value used to specify the memory range. Like PhysBase, PhysMask is aligned on a 4-Kbyte physical-address boundary. Bits 11:0 of PhysMask are assumed to be 0.

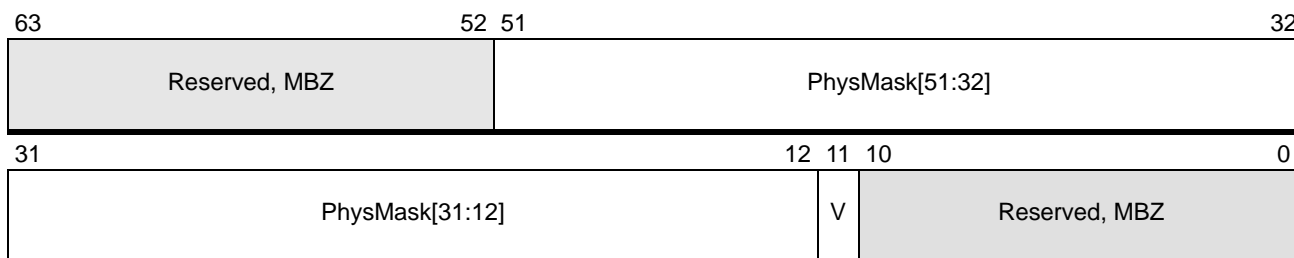

Bits	Mnemonic	Description	R/W
63:52	Reserved	Reserved, Must be Zero	
51:12	PhysMask	Range Physical Mask	R/W
11	V	MTRR Pair Enable (Valid)	R/W
10:0	Reserved	Reserved, Must be Zero	

**Figure 7-7. MTRRphysMaskn Register**

PhysMask and PhysBase are used together to determine whether a target physical-address falls within the specified address range. PhysMask is logically ANDed with PhysBase and separately ANDed with the upper 40 bits of the target physical-address. If the results of the two operations are identical, the target physical-address falls within the specified memory range. The pseudo-code for the operation is:

```
MaskBase = PhysMask AND PhysBase
MaskTarget = PhysMask AND Target_Address[51:12]
IF MaskBase == MaskTarget
    target address is in range
ELSE
    target address is not in range
```

**Variable Range Size and Alignment.** The size and alignment of variable memory-ranges (MTRRs) and I/O ranges (IORRs) are restricted as follows:

- The boundary on which a variable range is aligned must be equal to the range size. For example, a memory range of 16 Mbytes must be aligned on a 16-Mbyte boundary.
- The range size must be a power of 2 ( $2^n$ ,  $52 > n > 11$ ), with a minimum allowable size of 4 Kbytes. For example, 4 Mbytes and 8 Mbytes are allowable memory range sizes, but 6 Mbytes is not allowable.

**PhysMask and PhysBase Values.** Software can calculate the PhysMask value using the following procedure:

1. Subtract the memory-range physical base-address from the upper physical-address of the memory range.
2. Subtract the value calculated in Step 1 from the physical memory size.
3. Truncate the lower 12 bits of the result in Step 2 to create the PhysMask value to be loaded into the MTRRphysMask $n$  register. Truncation is performed by right-shifting the value 12 bits.

For example, assume a 32-Mbyte memory range is specified within the 52-bit physical address space, starting at address 200\_0000h. The upper address of the range is 3FF\_FFFFh. Following the process outlined above yields:

1. 3FF\_FFFFh–200\_0000h = 1FF\_FFFFh
2. F\_FFFF\_FFFF\_FFFF–1FF\_FFFFh = F\_FFFF\_FE00\_0000h
3. Right shift (F\_FFFF\_FE00\_0000h) by 12 = FF\_FFFF\_E000h

In this example, the 40-bit value loaded into the PhysMask field is FF\_FFFF\_E000h.

Software must also truncate the lower 12 bits of the physical base-address before loading it into the PhysBase field. In the example above, the 40-bit PhysBase field is 00\_0000\_2000h.

**Default-Range MTRRs.** Physical addresses that are not within ranges established by fixed-range and variable-range MTRRs are set to a default memory-type using the MTRRdefType register. The format of this register is shown in Figure 7-8.

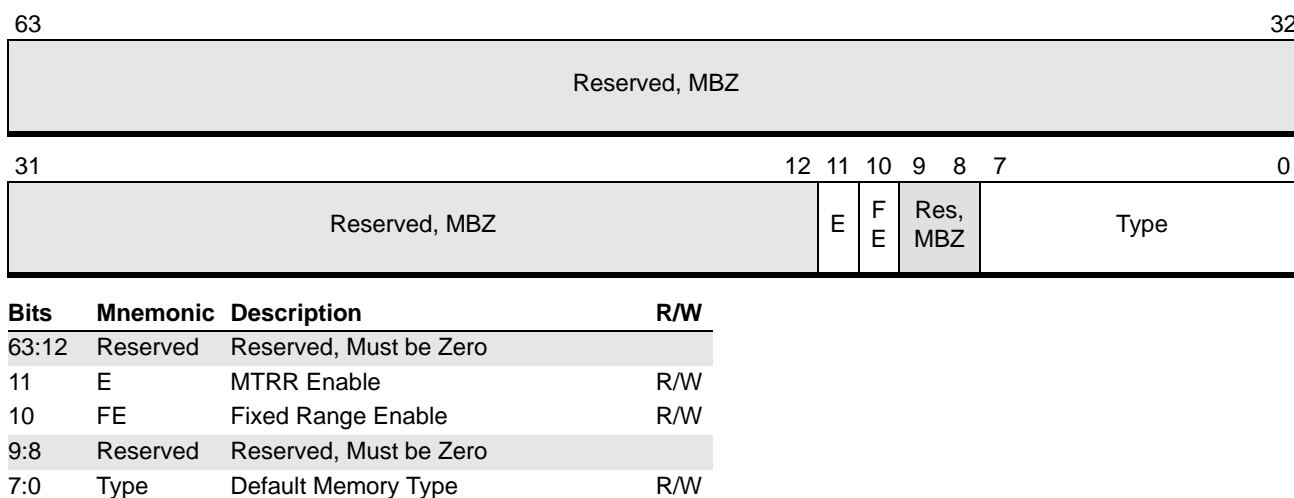

**Figure 7-8. MTRR defType Register Format**

The fields within the MTRRdefType register are read/write. These fields are:

- *Type*—Bits 7:0. The default memory-type used to characterize physical-memory space. See Table 7-5 on page 189 for the type-field encodings. The extended type-field encodings are not supported by this register.
- *Fixed-Range Enable (FE)*—Bit 10. All fixed-range MTRRs are enabled when FE is set to 1. Clearing FE to 0 disables all fixed-range MTRRs. Setting and clearing FE has no effect on the variable-range MTRRs. The FE bit has no effect unless the E bit is set to 1 (see below).
- *MTRR Enable (E)*—Bit 11. This is the MTRR memory typing enable bit. The memory typing capabilities of all fixed-range and variable-range MTRRs are enabled when E is set to 1. Clearing E to 0 disables the memory typing capabilities of all fixed-range and variable-range MTRRs and sets the default memory-type to uncacheable (UC) regardless of the value of the Type field. This bit does not affect the operation of the RdMem and WrMem fields.

### 7.7.3 Using MTRRs

**Identifying MTRR Features.** Software determines whether a processor supports the MTRR mechanism by executing the CPUID instruction with either function 0000\_0001h or function 8000\_0001h. If MTRRs are supported, bit 12 in the EDX register is set to 1 by CPUID. See “Processor Feature Identification” on page 63 for more information on the CPUID instruction.

The MTRR capability register (MTRRcap) is a read-only register containing information describing the level of MTRR support provided by the processor. Figure 7-9 shows the format of this register. If MTRRs are supported, software can read MTRRcap using the RDMSR instruction. Attempting to write to the MTRRcap register causes a general-protection exception (#GP).

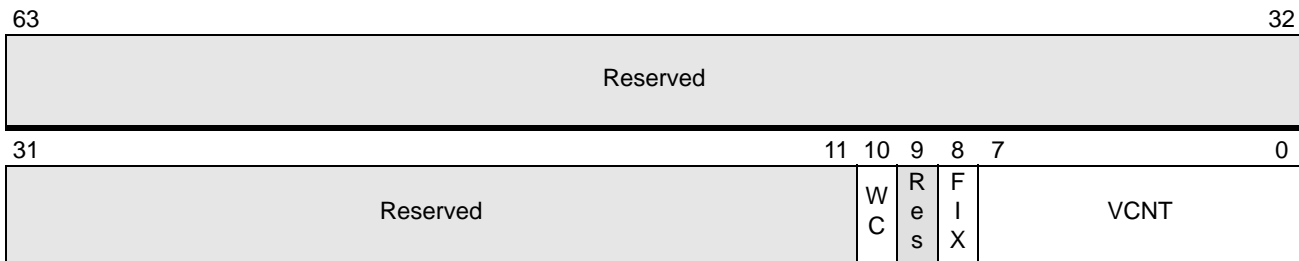

Bits	Mnemonic	Description	R/W
63:11	Reserved	Reserved	
10	WC	Write Combining	R
9	Reserved	Reserved	
8	FIX	Fixed-Range Registers	R
7:0	VCNT	Variable-Range Register Count	R

**Figure 7-9. MTRR Capability Register Format**

The MTRRcap register field are:

- *Variable-Range Register Count (VCNT)*—Bits 7:0. The VCNT field contains the number of variable-range register pairs supported by the processor. For example, a processor supporting eight register pairs returns a 08h in this field.
- *Fixed-Range Registers (FIX)*—Bit 8. The FIX bit indicates whether or not the fixed-range registers are supported. If the processor returns a 1 in this bit, *all* fixed-range registers are supported. If the processor returns a 0 in this bit, *no* fixed-range registers are supported.
- *Write-Combining (WC)*—Bit 10. The WC bit indicates whether or not the write-combining memory type is supported. If the processor returns a 1 in this bit, WC memory is supported, otherwise it is not supported.

#### 7.7.4 MTRRs and Page Cache Controls

When paging and the MTRRs are both enabled, the address ranges defined by the MTRR registers can span multiple pages, each of which can characterize memory with different types (using the PCD and PWT page bits). When caching is enabled (CR0.CD=0 and CR0.NW=0), the *effective memory type* is determined as follows:

1. If the page is defined as cacheable and writeback (PCD=0 and PWT=0), then the MTRR defines the effective memory-type.
2. If the page is defined as not cacheable (PCD=1), then UC is the effective memory-type.
3. If the page is defined as cacheable and writethrough (PCD=0 and PWT=1), then the MTRR defines the effective memory-type *unless* the MTRR specifies WB memory, in which case WT is the effective memory-type.

Table 7-7 lists the MTRR and page-level cache-control combinations and their combined effect on the final memory-type, if the PAT register holds the default settings.

**Table 7-7. Combined MTRR and Page-Level Memory Type with Unmodified PAT MSR**

MTRR Memory Type	Page PCD Bit	Page PWT Bit	Effective Memory-Type
UC	—	—	UC
WC	0	—	WC
	1	0	WC <sup>1</sup>
WP	1	1	UC
	0	—	WP
WT	1	—	UC
	0	—	WT
	1	—	UC

**Note:**  
1. The effective memory-type resulting from the combination of PCD=1, PWT=0, and an MTRR WC memory type is implementation dependent.

**Table 7-7. Combined MTRR and Page-Level Memory Type with Unmodified PAT MSR (continued)**

MTRR Memory Type	Page PCD Bit	Page PWT Bit	Effective Memory-Type
WB	0	0	WB
	0	1	WT
	1	—	UC
<b>Note:</b>			
1. The effective memory-type resulting from the combination of PCD=1, PWT=0, and an MTRR WC memory type is implementation dependent.			

**Large Page Sizes.** When paging is enabled, software can use large page sizes (2 Mbytes and 4 Mbytes) in addition to the more typical 4-Kbyte page size. When large page sizes are used, it is possible for multiple MTRRs to span the memory range within a single large page. Each MTRR can characterize the regions within the page with different memory types. If this occurs, the effective memory-type used by the processor within the large page is undefined.

Software can avoid the undefined behavior in one of the following ways:

- Avoid using multiple MTRRs to characterize a single large page.
- Use multiple 4-Kbyte pages rather than a single large page.
- If multiple MTRRs must be used within a single large page, software can set the MTRR type fields to the same value.
- If the multiple MTRRs must have different type-field values, software can set the large page PCD and PWT bits to the most restrictive memory type defined by the multiple MTRRs.

**Overlapping MTRR Registers.** If the address ranges of two or more MTRRs overlap, the following rules are applied to determine the memory type used to characterize the overlapping address range:

1. Fixed-range MTRRs, which characterize only the first 1 Mbyte of physical memory, have precedence over variable-range MTRRs.
2. If two or more variable-range MTRRs overlap, the following rules apply:
  - a. If the memory types are identical, then that memory type is used.
  - b. If at least one of the memory types is UC, the UC memory type is used.
  - c. If at least one of the memory types is WT, and the only other memory type is WB, then the WT memory type is used.
  - d. If the combination of memory types is not listed Steps A through C immediately above, then the memory type used is undefined.

### 7.7.5 MTRRs in Multi-Processing Environments

In multi-processing environments, the MTRRs located in all processors must characterize memory in the same way. Generally, this means that identical values are written to the MTRRs used by the

processors. This also means that values CR0.CD and the PAT must be consistent across processors. Failure to do so may result in coherency violations or loss of atomicity. Processor implementations *do not* check the MTRR settings in other processors to ensure consistency. It is the responsibility of system software to initialize and maintain MTRR consistency across all processors.

## 7.8 Page-Attribute Table Mechanism

The page-attribute table (PAT) mechanism extends the page-table entry format and enhances the capabilities provided by the PCD and PWT page-level cache controls. PAT (and PCD, PWT) allow memory-type characterization based on the virtual (linear) address. The PAT mechanism provides the same memory-typing capabilities as the MTRRs but with the added flexibility of the paging mechanism. Software can use both the PAT and MTRR mechanisms to maximize flexibility in memory-type control.

### 7.8.1 PAT Register

Like the MTRRs, the PAT register is a 64-bit model-specific register (MSR). The format of the PAT registers is shown in Figure 7-10. See “Memory-Typing MSRs” on page 572 for more information on the PAT MSR number and reset value.

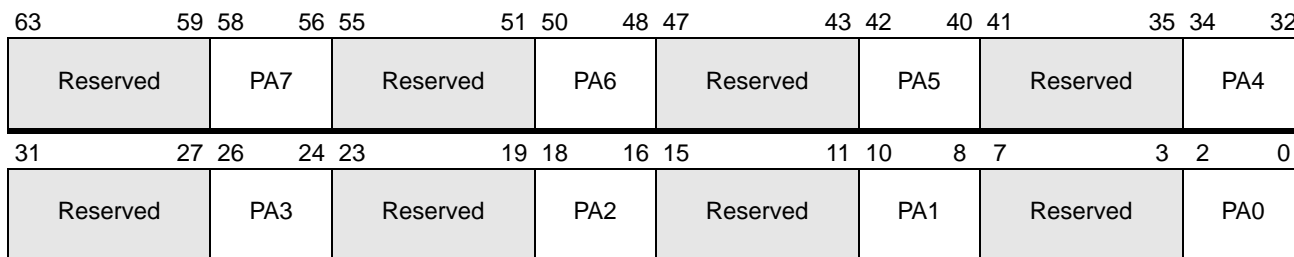

**Figure 7-10. PAT Register**

The PAT register contains eight page-attribute (PA) fields, numbered from PA0 to PA7. The PA fields hold the encoding of a memory type, as found in Table 7-8 on page 200. The PAT type-encodings match the MTRR type-encodings, with the exception that PAT adds the 07h encoding. The 07h encoding corresponds to a UC<sup>-</sup> type. The UC<sup>-</sup> type (07h) is identical to the UC type (00h) except it can be overridden by an MTRR type of WC.

Software can write any supported memory-type encoding into any of the eight PA fields. An attempt to write anything but zeros into the reserved fields causes a general-protection exception (#GP). An attempt to write an unsupported type encoding into a PA field also causes a #GP exception.

The PAT register fields are initiated at processor reset to the default values shown in Table 7-9 on page 201.

**Table 7-8. PAT Type Encodings**

Type Value	Type Name	Type Description
00h	UC—Uncacheable	All accesses are uncacheable. Write combining is not allowed. Speculative accesses are not allowed.
01h	WC—Write-Combining	All accesses are uncacheable. Write combining is allowed. Speculative reads are allowed.
04h	WT—Writethrough	Reads allocate cache lines on a cache miss, but only to the shared state. Cache lines are not allocated on a write miss. Write hits update the cache and main memory.
05h	WP—Write-Protect	Reads allocate cache lines on a cache miss, but only to the shared state. All writes update main memory. Cache lines are not allocated on a write miss. Write hits invalidate the cache line and update main memory.
06h	WB—Writeback	Reads allocate cache lines on a cache miss, and can allocate to either the shared or exclusive state. Writes allocate to the modified state on a cache miss.
07h	UC— (UC minus)	All accesses are uncacheable. Write combining is not allowed. Speculative accesses are not allowed. Can be overridden by an MTRR with the WC type.

### 7.8.2 PAT Indexing

PA fields in the PAT register are selected using three bits from the page-table entries. These bits are:

- *PAT (page attribute table)*—The PAT bit is bit 7 in 4-Kbyte PTEs; it is bit 12 in 2-Mbyte and 4-Mbyte PDEs. Page-table entries that don't have a PAT bit (PML4 entries, for example) assume PAT = 0.
- *PCD (page cache disable)*—The PCD bit is bit 4 in all page-table entries. The PCD from the PTE or PDE is selected depending on the paging mode.
- *PWT (page writethrough)*—The PWT bit is bit 3 in all page-table entries. The PWT from the PTE or PDE is selected depending on the paging mode.

Table 7-9 on page 201 shows the various combinations of the PAT, PCD, and PWT bits used to select a PA field within the PAT register. Table 7-9 also shows the default memory-type values established in the PAT register by the processor after a reset. The default values correspond to the memory types established by the PCD and PWT bits alone in processor implementations that do not support the PAT mechanism. In such implementations, the PAT field in page-table entries is reserved and cleared to 0. See “Page-Translation-Table Entry Fields” on page 137 for more information on the page-table entries.



**Table 7-9. PAT-Register PA-Field Indexing**

Page-Table Entry Bits			PAT Register Field	Default Memory Type
PAT	PCD	PWT		
0	0	0	PA0	WB
0	0	1	PA1	WT
0	1	0	PA2	UC <sup>-1</sup>
0	1	1	PA3	UC
1	0	0	PA4	WB
1	0	1	PA5	WT
1	1	0	PA6	UC <sup>-1</sup>
1	1	1	PA7	UC

**Note:**  
1. Can be overridden by WC memory type set by an MTRR.

### 7.8.3 Identifying PAT Support

Software determines whether a processor supports the PAT mechanism by executing the CPUID instruction with either function 0000\_0001h or function 8000\_0001h. If PAT is supported, bit 16 in the EDX register is set to 1 by CPUID. See Section 3.3, “Processor Feature Identification,” on page 63 for more information on the CPUID instruction.

If PAT is supported by a processor implementation, it is *always enabled*. The PAT mechanism cannot be disabled by software. Software can effectively avoid using PAT by:

- Not setting PAT bits in page-table entries to 1.
- Not modifying the reset values of the PA fields in the PAT register.

In this case, memory is characterized using the same types that are used by implementations that do not support PAT.

### 7.8.4 PAT Accesses

In implementations that support the PAT mechanism, all memory accesses that are translated through the paging mechanism use the PAT index bits to specify a PA field in the PAT register. The memory type stored in the specified PA field is applied to the memory access. The process is summarized as:

1. A virtual address is calculated as a result of a memory access.
2. The virtual address is translated to a physical address using the page-translation mechanism.
3. The PAT, PCD and PWT bits are read from the corresponding page-table entry during the virtual-address to physical-address translation.
4. The PAT, PCD and PWT bits are used to select a PA field from the PAT register.
5. The memory type is read from the appropriate PA field.
6. The memory type is applied to the physical-memory access using the translated physical address.

**Page-Translation Table Access.** The PAT bit exists only in the PTE (4-K paging) or PDEs (2/4 Mbyte paging). In the remaining upper levels (PML4, PDP, and 4K PDEs), only the PWT and PCD bits are used to index into the first 4 entries in the PAT register. The resulting memory type is used for the next lower paging level.

### 7.8.5 Combined Effect of MTRRs and PAT

The memory types established by the PAT mechanism can be combined with MTRR-established memory types to form an effective memory-type. The combined effect of MTRR and PAT memory types are shown in Figure 7-10. In the AMD64 architecture, reserved and undefined combinations of MTRR and PAT memory types result in undefined behavior. If the MTRRs are disabled in implementations that support the MTRR mechanism, the default memory type is set to uncacheable (UC).

**Table 7-10. Combined Effect of MTRR and PAT Memory Types**

PAT Memory Type	MTRR Memory Type	Effective Memory Type
UC	UC	UC
UC	WC, WP, WT, WB	CD
UC-	UC	UC
	WC	WC
	WP, WT, WB	CD
WC	—	WC
WP	UC	UC
	WC	CD
	WP	WP
	WT	CD
	WB	WP
WT	UC	UC
	WC, WP	CD
	WT, WB	WT
WB	UC	UC
	WC	WC
	WP	WP
	WT	WT
	WB	WB

### 7.8.6 PATs in Multi-Processing Environments

In multi-processing environments, values of CR0[CD] and the PAT must be consistent across all processors and the MTRRs in all processors must characterize memory in the same way. In other words, matching address ranges and cachability types are written to the MTRRs for each processor.

Failure to do so may result in coherency violations or loss of atomicity. Processor implementations *do not* check the MTRR, CR0.CD and PAT values in other processors to ensure consistency. It is the responsibility of system software to initialize and maintain consistency across all processors.

### 7.8.7 Changing Memory Type

A physical page should not have differing cacheability types assigned to it through different virtual mappings; they should be either all of a cacheable type (WB, WT, WP) or all of a non-cacheable type (UC, WC, CD). Otherwise, this may result in a loss of cache coherency, leading to stale data and unpredictable behavior. For this reason, certain precautions must be taken when changing the memory type of a page. In particular, when changing from a cachable memory type to an uncachable type the caches must be flushed, because speculative execution by the processor may have resulted in memory being cached even though it was not programatically referenced. The following table summarizes the serialization requirements for safely changing memory types.

**Table 7-11. Serialization Requirements for Changing Memory Types**

		New Type				
		WB	WT	WP	UC	WC
Old Type	WB	–	a	a	b	b
	WT	a	–	a	b	b
	WP	a	a	–	b	b
	UC	a	a	a	–	a
	WC	a	a	a	a	–

**Note:**

- Remove the previous mapping (make it not present in the page tables); Flush the TLBs including the TLBs of other processors that may have used the mapping, even speculatively; Create a new mapping in the page tables using the new type.
- In addition to the steps described in note a, software should flush the page from the caches of any processor that may have used the previous mapping.

## 7.9 Memory-Mapped I/O

Processor implementations can independently direct reads and writes to either system memory or memory-mapped I/O. The method used for directing those memory accesses is implementation dependent. In some implementations, separate system-memory and memory-mapped I/O buses can be provided at the processor interface. In other implementations, system memory and memory-mapped I/O share common data and address buses, and system logic uses sideband signals from the processor to route accesses appropriately. Refer to AMD data sheets and application notes for more information about particular hardware implementations of the AMD64 architecture.

The I/O range registers (IORRs), and the top-of-memory registers allow system software to specify where memory accesses are directed for a given address range. The MTRR extensions are described in the following section. “IORRs” on page 206 describes the IORRs and “Top of Memory” on page 208 describes the top-of-memory registers. *In implementations that support these features, the default action taken when the features are disabled is to direct memory accesses to memory-mapped I/O.*

### 7.9.1 Extended Fixed-Range MTRR Type-Field Encodings

The fixed-range MTRRs support extensions to the type-field encodings that allow system software to direct memory accesses to system memory or memory-mapped I/O. The extended MTRR type-field encodings use previously reserved bits 4:3 to specify whether reads and writes to a physical-address range are to system memory or to memory-mapped I/O. The format for this encoding is shown in Figure 7-11 on page 204. The new bits are:

- *WrMem*—Bit 3. When set to 1, the processor directs write requests for this physical address range to system memory. When cleared to 0, writes are directed to memory-mapped I/O.
- *RdMem*—Bit 4. When set to 1, the processor directs read requests for this physical address range to system memory. When cleared to 0, reads are directed to memory-mapped I/O.

The type subfield (bits 2:0) allows the encodings specified in Table 7-5 on page 189 to be used for memory characterization.

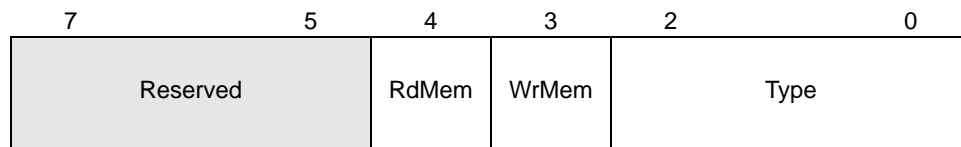

**Figure 7-11. Extended MTRR Type-Field Format (Fixed-Range MTRRs)**

These extensions are enabled using the following bits in the SYSCFG MSR:

- *MtrrFixDramEn*—Bit 18. When set to 1, *RdMem* and *WrMem* attributes are enabled. When cleared to 0, these attributes are disabled. *When disabled, accesses are directed to memory-mapped I/O space.*
- *MtrrFixDramModEn*—Bit 19. When set to 1, software can read and write the *RdMem* and *WrMem* bits. When cleared to 0, writes do not modify the *RdMem* and *WrMem* bits, and reads return 0.

To use the MTRR extensions, system software must first set *MtrrFixDramModEn*=1 to allow modification to the *RdMem* and *WrMem* bits. After the attribute bits are properly initialized in the fixed-range registers, the extensions can be enabled by setting *MtrrFixDramEn*=1.

*RdMem* and *WrMem* allow the processor to independently direct reads and writes to either system memory or memory-mapped I/O. The *RdMem* and *WrMem* controls are particularly useful when shadowing ROM devices located in memory-mapped I/O space. It is often useful to shadow such devices in RAM system memory to improve access performance, but writes into the RAM location can

corrupt the shadowed ROM information. The MTRR extensions solve this problem. System software can create the shadow location by setting  $WrMem = 1$  and  $RdMem = 0$  for the specified memory range and then copy the ROM location into itself. Reads are directed to the memory-mapped ROM, but writes go to the same physical addresses in system memory. After the copy is complete, system software can change the bit values to  $WrMem = 0$  and  $RdMem = 1$ . Now reads are directed to the faster copy located in system memory, and writes are directed to memory-mapped ROM. The ROM responds as it would normally to a write, which is to ignore it.

Not all combinations of  $RdMem$  and  $WrMem$  are supported for each memory type encoded by bits 2:0. Table 7-12 on page 206 shows the allowable combinations. The behavior of reserved encoding combinations (shown as gray-shaded cells) is undefined and results in unpredictable behavior.

**Table 7-12. Extended Fixed-Range MTRR Type Encodings**

RdMem	WrMem	Type	Implication or Potential Use
0	0	0 (UC)	UC I/O
		1 (WC)	WC I/O
		4 (WT)	WT I/O
		5 (WP)	WP I/O
		6 (WB)	Reserved
0	1	0 (UC)	Used while creating a shadowed ROM
		1 (WC)	
		4 (WT)	Reserved
		5 (WP)	
		6 (WB)	
1	0	0 (UC)	Used to access a shadowed ROM
		1 (WC)	Reserved
		4 (WT)	
		5 (WP)	WP Memory (Can be used to access shadowed ROM)
		6 (WB)	Reserved
1	1	0 (UC)	UC Memory
		1 (WC)	WC Memory
		4 (WT)	WT Memory
		5 (WP)	Reserved
		6 (WB)	WB Memory

### 7.9.2 IORRs

The IORRs operate similarly to the variable-range MTRRs. The IORRs specify whether reads and writes in any physical-address range map to system memory or memory-mapped I/O. Up to two address ranges of varying sizes can be controlled using the IORRs. A pair of IORRs are used to control each address range: *IORRBase<sub>n</sub>* and *IORRMask<sub>n</sub>* (*n* is the address-range number from 0 to 1).

Figure 7-12 on page 207 shows the format of the *IORRBase<sub>n</sub>* registers and Figure 7-13 on page 208 shows the format of the *IORRMask<sub>n</sub>* registers. The fields within the register pair are read/write.

The intersection of the IORR range with the equivalent effective MTRR range follows the same type encoding table (Table 7-12) as the fixed-range MTRR, where the RdMem/WrMem and memory type are directly tied together.

**IORRBase<sub>n</sub> Registers.** The fields in these IORRs are:

- *WrMem*—Bit 3. When set to 1, the processor directs write requests for this physical address range to system memory. When cleared to 0, writes are directed to memory-mapped I/O.

- *RdMem*—Bit 4. When set to 1, the processor directs read requests for this physical address range to system memory. When cleared to 0, reads are directed to memory-mapped I/O.
- *Range Physical-Base-Address (PhysBase)*—Bits 51:12. The memory-range base-address in physical-address space. PhysBase is aligned on a 4-Kbyte (or greater) address in the 52-bit physical-address space supported by the AMD64 architecture. PhysBase represents the most-significant 40-address bits of the physical address. Physical-address bits 11:0 are assumed to be 0.

Note that a given processor may implement less than the architecturally-defined physical address size of 52 bits.

The format of these registers is shown in Figure 7-12.

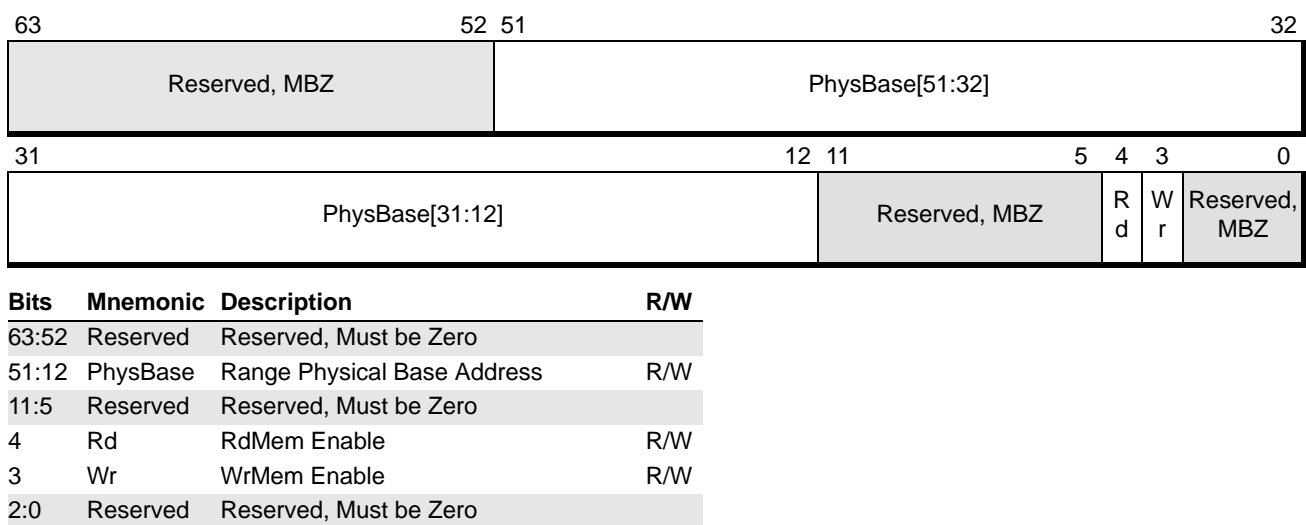
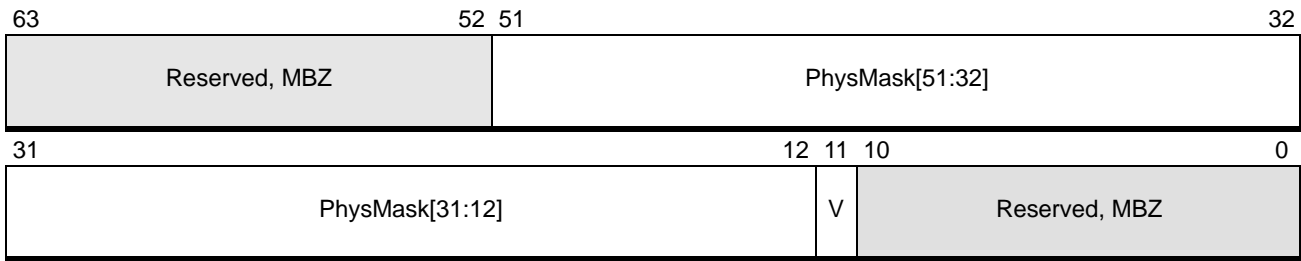

**Figure 7-12. IORRBase $n$  Register**

**IORRMask $n$  Registers.** The fields in these IORRs are:

- *Valid (V)*—Bit 11. Indicates that the IORR pair is valid (enabled) when set to 1. When the valid bit is cleared to 0 the register pair is not used for memory-mapped I/O control (disabled).
- *Range Physical-Mask (PhysMask)*—Bits 51:12. The mask value used to specify the memory range. Like PhysBase, PhysMask is aligned on a 4-Kbyte physical-address boundary. Bits 11:0 of PhysMask are assumed to be 0.

The format of these registers is shown in Figure 7-13 on page 208.



Bits	Mnemonic	Description	R/W
63:52	Reserved	Reserved, Must be Zero	
51:12	PhysMask	Range Physical Mask	R/W
11	V	I/O Register Pair Enable (Valid)	R/W
10:0	Reserved	Reserved, Must be Zero	

**Figure 7-13. IORRMaskn Register**

The operation of the PhysMask and PhysBase fields is identical to that of the variable-range MTRRs. See page 193 for a description of this operation.

### 7.9.3 IORR Overlapping

The use of overlapping IORRs is not recommended. If overlapping IORRs are specified, the resulting behavior is implementation-dependent.

### 7.9.4 Top of Memory

The *top-of-memory* registers, TOP\_MEM and TOP\_MEM2, allow system software to specify physical addresses ranges as memory-mapped I/O locations. Processor implementations can direct accesses to memory-mapped I/O differently than system I/O, and the precise method depends on the implementation. System software specifies memory-mapped I/O regions by writing an address into each of the top-of-memory registers. The memory regions specified by the TOP\_MEM registers are aligned on 8-Mbyte boundaries as follows:

- Memory accesses from physical address 0 to one less than the value in TOP\_MEM are directed to system memory.
- Memory accesses from the physical address specified in TOP\_MEM to FFFF\_FFFFh are directed to memory-mapped I/O.
- Memory accesses from physical address 1\_0000\_0000h to one less than the value in TOP\_MEM2 are directed to system memory.
- Memory accesses from the physical address specified in TOP\_MEM2 to the maximum physical address supported by the system are directed to memory-mapped I/O.

Figure 7-14 on page 209 shows how the top-of-memory registers organize memory into separate system-memory and memory-mapped I/O regions.



The intersection of the top-of-memory range with the equivalent effective MTRR range follows the same type encoding table (Table 7-12 on page 206) as the fixed-range MTRR, where the RdMem/WrMem and memory type are directly tied together.

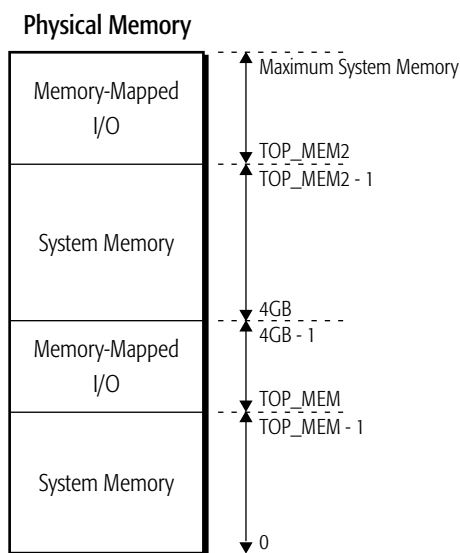

**Figure 7-14. Memory Organization Using Top-of-Memory Registers**

Figure 7-15 shows the format of the TOP\_MEM and TOP\_MEM2 registers. Bits 51:23 specify an 8-Mbyte aligned physical address. All remaining bits are reserved and ignored by the processor. System software should clear those bits to zero to maintain compatibility with possible future extensions to the registers. The TOP\_MEM registers are model-specific registers. See “Memory-Typing MSRs” on page 572 for information on the MSR address and reset values for these registers.

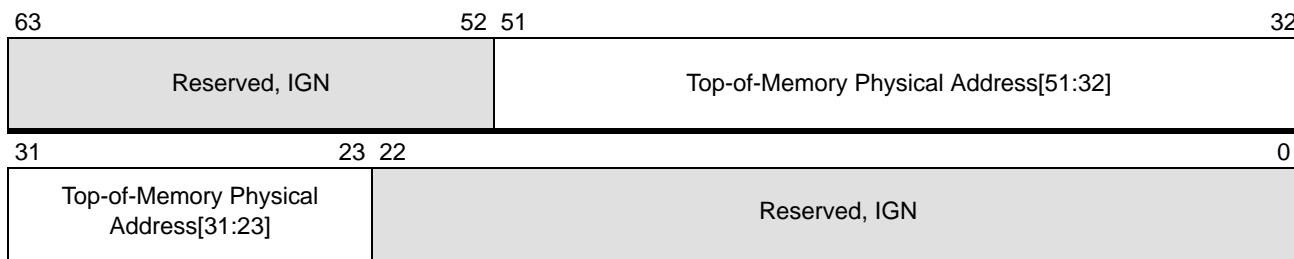

**Figure 7-15. Top-of-Memory Registers (TOP\_MEM, TOP\_MEM2)**

The TOP\_MEM register is enabled by setting the MtrrVarDramEn bit in the SYSCFG MSR (bit 20) to 1 (one). The TOP\_MEM2 register is enabled by setting the MtrrTom2En bit in the SYSCFG MSR (bit 21) to 1 (one). The registers are disabled when their respective enable bits are cleared to 0. When the top-of-memory registers are disabled, memory accesses default to memory-mapped I/O space.

Note that a given processor may implement fewer than the architecturally-defined number of physical address bits.

## 8 Exceptions and Interrupts

---

Exceptions and interrupts force control transfers from the currently-executing program to a system-software service routine that handles the interrupting event. These routines are referred to as *exception handlers* and *interrupt handlers*, or collectively as *event handlers*. Typically, interrupt events can be handled by the service routine transparently to the interrupted program. During the control transfer to the service routine, the processor stops executing the interrupted program and saves its return pointer. The system-software service routine that handles the exception or interrupt is responsible for saving the state of the interrupted program. This allows the processor to restart the interrupted program after system software has handled the event.

When an exception or interrupt occurs, the processor uses the interrupt vector number as an index into the interrupt-descriptor table (IDT). An IDT is used in all processor operating modes, including real mode (also called real-address mode), protected mode, and long mode.

Exceptions and interrupts come from three general sources:

- *Exceptions* occur as a result of software execution errors or other internal-processor errors. Exceptions also occur during non-error situations, such as program single stepping or address-breakpoint detection. Exceptions are considered *synchronous* events because they are a direct result of executing the interrupted instruction.
- *Software interrupts* occur as a result of executing interrupt instructions. Unlike exceptions and external interrupts, software interrupts allow intentional triggering of the interrupt-handling mechanism. Like exceptions, software interrupts are synchronous events.
- *External interrupts* are generated by system logic in response to an error or some other event outside the processor. They are reported over the processor bus using external signaling. External interrupts are *asynchronous* events that occur independently of the interrupted instruction.

Throughout this section, the term *masking* can refer to either disabling or delaying an interrupt. For example, masking external interrupts *delays* the interrupt, with the processor holding the interrupt as pending until it is unmasked. With floating-point exceptions (SSE and x87), masking *prevents* an interrupt from occurring and causes the processor to perform a default operation on the exception condition.

### 8.1 General Characteristics

Exceptions and interrupts have several different characteristics that depend on how events are reported and the implications for program restart.

#### 8.1.1 Precision

*Precision* describes how the exception is related to the interrupted program:

- *Precise* exceptions are reported on a predictable instruction boundary. This boundary is generally the first instruction that has not completed when the event occurs. All previous instructions (in

program order) are allowed to complete before transferring control to the event handler. The pointer to the instruction boundary is saved automatically by the processor. When the event handler completes execution, it returns to the interrupted program and restarts execution at the interrupted-instruction boundary.

- *Imprecise* exceptions are not guaranteed to be reported on a predictable instruction boundary. The boundary can be any instruction that has not completed when the interrupt event occurs. Imprecise events can be considered asynchronous, because the source of the interrupt is not necessarily related to the interrupted instruction. Imprecise exception and interrupt handlers typically collect machine-state information related to the interrupting event for reporting through system-diagnostic software. The interrupted program is not restartable.

### 8.1.2 Instruction Restart

As mentioned above, precise exceptions are reported on an instruction boundary. The instruction boundary can be reported in one of two locations:

- Most exceptions report the boundary *before* the instruction causing the exception. In this case, all previous instructions (in program order) are allowed to complete, but the interrupted instruction is not. *No program state is updated as a result of partially executing an interrupted instruction.*
- Some exceptions report the boundary *after* the instruction causing the exception. In this case, all previous instructions—including the one executing when the exception occurred—are allowed to complete.

Program state can be updated when the reported boundary is after the instruction causing the exception. This is particularly true when the event occurs as a result of a task switch. In this case, the general registers, segment-selector registers, page-base address register, and LDTR are all updated by the hardware task-switch mechanism. The event handler cannot rely on the state of those registers when it begins execution and must be careful in validating the state of the segment-selector registers before restarting the interrupted task. This is not an issue in long mode, however, because the hardware task-switch mechanism is disabled in long mode.

### 8.1.3 Types of Exceptions

There are three types of exceptions, depending on whether they are precise and how they affect program restart:

- *Faults* are precise exceptions reported on the boundary before the instruction causing the exception. Generally, faults are caused by an error condition involving the faulted instruction. Any machine-state changes caused by the faulting instruction are discarded so that the instruction can be restarted. The saved rIP points to the faulting instruction.
- *Traps* are precise exceptions reported on the boundary following the instruction causing the exception. The trapped instruction is completed by the processor and all state changes are saved. The saved rIP points to the instruction following the faulting instruction.
- *Aborts* are imprecise exceptions. Because they are imprecise, aborts typically do not allow reliable program restart.

### 8.1.4 Masking External Interrupts

**General Masking Capabilities.** Software can *mask* the occurrence of certain exceptions and interrupts. Masking can delay or even prevent triggering of the exception-handling or interrupt-handling mechanism when an interrupt-event occurs. External interrupts are classified as maskable or nonmaskable:

- *Maskable interrupts* trigger the interrupt-handling mechanism only when RFLAGS.IF=1. Otherwise they are held pending for as long as the RFLAGS.IF bit is cleared to 0.
- *Nonmaskable interrupts* (NMI) are unaffected by the value of the rFLAGS.IF bit. However, the occurrence of an NMI masks further NMIs until an IRET instruction is executed.

**Masking During Stack Switches.** The processor delays recognition of maskable external interrupts and debug exceptions during certain instruction sequences that are often used by software to switch stacks. The typical programming sequence used to switch stacks is:

1. Load a stack selector into the SS register.
2. Load a stack offset into the ESP register.

If an interrupting event occurs after the selector is loaded but before the stack offset is loaded, the interrupted-program stack pointer is invalid during execution of the interrupt handler.

To prevent interrupts from causing stack-pointer problems, the processor does not allow external interrupts or debug exceptions to occur until the instruction immediately following the MOV SS or POP SS instruction completes execution.

The recommended method of performing this sequence is to use the LSS instruction. LSS loads both SS and ESP, and the instruction inhibits interrupts until both registers are updated successfully.

### 8.1.5 Masking Floating-Point and Media Instructions

Any x87 floating-point exceptions can be masked and reported later using bits in the x87 floating-point status register (FSW) and the x87 floating-point control register (FCW). The floating-point exception-pending exception is used for unmasked x87 floating-point exceptions (see “#MF—x87 Floating-Point Exception-Pending (Vector 16)” on page 226).

The SIMD floating-point exception is used for unmasked SSE floating-point exceptions (see “#XF—SIMD Floating-Point Exception (Vector 19)” on page 229). SSE floating-point exceptions are masked using the MXCSR register. The exception mechanism is not triggered when these exceptions are masked. Instead, the processor handles the exceptions in a default manner.

### 8.1.6 Disabling Exceptions

Disabling an exception prevents the exception condition from being recognized, unlike masking an exception which prevents triggering the exception mechanism after the exception is recognized. Some exceptions can be disabled by system software running at CPL=0, using bits in the CR0 register or CR4 register:

- Alignment-check exception (see “#AC—Alignment-Check Exception (Vector 17)” on page 227).
- Device-not-available exception (see “#NM—Device-Not-Available Exception (Vector 7)” on page 220).
- Machine-check exception (see “#MC—Machine-Check Exception (Vector 18)” on page 228).

The debug-exception mechanism provides control over when specific breakpoints are enabled and disabled. See “Setting Breakpoints” on page 355 for more information on how breakpoint controls are used for triggering the debug-exception mechanism.

## 8.2 Vectors

Specific exception and interrupt sources are assigned a fixed vector-identification number (also called an “interrupt vector” or simply “vector”). The interrupt vector is used by the interrupt-handling mechanism to locate the system-software service routine assigned to the exception or interrupt. Up to 256 unique interrupt vectors are available. The first 32 vectors are reserved for predefined exception and interrupt conditions. Software-interrupt sources can trigger an interrupt using any available interrupt vector.

Table 8-1 on page 215 lists the supported interrupt vector numbers, the corresponding exception or interrupt name, the mnemonic, the source of the interrupt event, and a summary of the possible causes.

**Table 8-1. Interrupt Vector Source and Cause**

Vector	Exception/Interrupt	Mnemonic	Cause
0	Divide-by-Zero-Error	#DE	DIV, IDIV, AAM instructions
1	Debug	#DB	Instruction accesses and data accesses
2	Non-Maskable-Interrupt	#NMI	External NMI signal
3	Breakpoint	#BP	INT3 instruction
4	Overflow	#OF	INTO instruction
5	Bound-Range	#BR	BOUND instruction
6	Invalid-Opcode	#UD	Invalid instructions
7	Device-Not-Available	#NM	x87 instructions
8	Double-Fault	#DF	Exception during the handling of another exception or interrupt
9	Coprocessor-Segment-Overrun	—	Unsupported (Reserved)
10	Invalid-TSS	#TS	Task-state segment access and task switch
11	Segment-Not-Present	#NP	Segment register loads
12	Stack	#SS	SS register loads and stack references
13	General-Protection	#GP	Memory accesses and protection checks
14	Page-Fault	#PF	Memory accesses when paging enabled
15	Reserved	—	—
16	x87 Floating-Point Exception-Pending	#MF	x87 floating-point instructions
17	Alignment-Check	#AC	Misaligned memory accesses
18	Machine-Check	#MC	Model specific
19	SIMD Floating-Point	#XF	SSE floating-point instructions
20–29	Reserved	—	—
30	Security Exception	#SX	Security-sensitive event in host
31	Reserved	—	—
0–255	External Interrupts (Maskable)	#INTR	External interrupts
0–255	Software Interrupts	—	INT $n$ instruction

Table 8-2 on page 216 shows how each interrupt vector is classified. Reserved interrupt vectors are indicated by the gray-shaded rows.

**Table 8-2. Interrupt Vector Classification**

Vector	Interrupt (Exception)	Type	Precise	Class <sup>2</sup>
0	Divide-by-Zero-Error	Fault	yes	Contributory
1	Debug	Fault or Trap		
2	Non-Maskable-Interrupt	—	—	Benign
3	Breakpoint	Trap	yes	
4	Overflow			
5	Bound-Range	Fault		
6	Invalid-Opcode			
7	Device-Not-Available			
8	Double-Fault	Abort	no	
9	Coprocessor-Segment-Overrun			
10	Invalid-TSS	Fault	yes	Contributory
11	Segment-Not-Present			
12	Stack			
13	General-Protection			
14	Page-Fault			Benign or Contributory
15	Reserved			
16	x87 Floating-Point Exception-Pending	Fault	no	Benign
17	Alignment-Check		yes	
18	Machine-Check	Abort	no	
19	SIMD Floating-Point	Fault	yes	
20–29	Reserved			
30	Security Exception	—	yes	Contributory
31	Reserved			
0–255	External Interrupts (Maskable)	— <sup>1</sup>	— <sup>1</sup>	Benign
0–255	Software Interrupts			
<b>Note:</b>				
1. External interrupts are not classified by type or whether or not they are precise.				
2. See “#DF—Double-Fault Exception (Vector 8)” on page 220 for a definition of benign and contributory classes.				

The following sections describe each interrupt in detail. The format of the error code reported by each interrupt is described in “Error Codes” on page 230.



### 8.2.1 #DE—Divide-by-Zero-Error Exception (Vector 0)

A #DE exception occurs when the denominator of a DIV instruction or an IDIV instruction is 0. A #DE also occurs if the result is too large to be represented in the destination.

#DE cannot be disabled.

**Error Code Returned.** None.

**Program Restart.** #DE is a fault-type exception. The saved instruction pointer points to the instruction that caused the #DE.

### 8.2.2 #DB—Debug Exception (Vector 1)

When the debug-exception mechanism is enabled, a #DB exception can occur under any of the following circumstances:

- Instruction execution.
- Instruction single stepping.
- Data read.
- Data write.
- I/O read.
- I/O write.
- Task switch.
- Debug-register access, or *general detect fault* (*debug register access when DR7.GD=1*).
- Executing the INT1 instruction (opcode 0F1h).

#DB conditions are enabled and disabled using the debug-control register, DR7 and RFLAGS.TF. Each #DB condition is described in more detail in “Setting Breakpoints” on page 355.

**Error Code Returned.** None. #DB information is returned in the debug-status register, DR6.

**Program Restart.** #DB can be either a fault-type or trap-type exception. In the following cases, the saved instruction pointer points to the instruction that caused the #DB:

- Instruction execution.
- Invalid debug-register access, or *general detect*.

In all other cases, the instruction that caused the #DB is completed, and the saved instruction pointer points to the instruction after the one that caused the #DB.

The RFLAGS.RF bit can be used to restart an instruction following an instruction breakpoint resulting in a #DB. In most cases, the processor clears RFLAGS.RF to 0 after every instruction is successfully executed. However, in the case of the IRET, JMP, CALL, and INT $n$  (through a task gate) instructions, RFLAGS.RF is not cleared to 0 until the *next* instruction successfully executes.

When a non-debug exception occurs (or when a string instruction is interrupted), the processor normally sets RFLAGS.RF to 1 in the RFLAGS *image* that is pushed on the interrupt stack. A subsequent IRET back to the interrupted program pops the RFLAGS image off the stack and into the RFLAGS register, with RFLAGS.RF=1. The interrupted instruction executes without causing an instruction breakpoint, after which the processor clears RFLAGS.RF to 0.

However, when a #DB exception occurs, the processor clears RFLAGS.RF to 0 in the RFLAGS image that is pushed on the interrupt stack. The #DB handler has two options:

- Disable the instruction breakpoint completely.
- Set RFLAGS.RF to 1 in the interrupt-stack RFLAGS image. The instruction breakpoint condition is ignored immediately after the IRET, but reoccurs if the instruction address is accessed later, as can occur in a program loop.

### 8.2.3 NMI—Non-Maskable-Interrupt Exception (Vector 2)

An NMI exception occurs as a result of system logic signaling a non-maskable interrupt to the processor.

**Error Code Returned.** None.

**Program Restart.** NMI is an interrupt. The processor recognizes an NMI at an instruction boundary. The saved instruction pointer points to the instruction immediately following the boundary where the NMI was recognized.

**Masking.** NMI cannot be masked. However, when an NMI is recognized by the processor, recognition of subsequent NMIs are disabled until an IRET instruction is executed.

### 8.2.4 #BP—Breakpoint Exception (Vector 3)

A #BP exception occurs when an INT3 instruction is executed. The INT3 is normally used by debug software to set instruction breakpoints by replacing instruction-opcode bytes with the INT3 opcode.

#BP cannot be disabled.

**Error Code Returned.** None.

**Program Restart.** #BP is a trap-type exception. The saved instruction pointer points to the byte after the INT3 instruction. This location can be the start of the next instruction. However, if the INT3 is used to replace the first opcode bytes of an instruction, the restart location is likely to be in the middle of an instruction. In the latter case, the debug software must replace the INT3 byte with the correct instruction byte. The saved RIP instruction pointer must then be decremented by one before returning to the interrupted program. This allows the program to be restarted correctly on the interrupted-instruction boundary.

### 8.2.5 #OF—Overflow Exception (Vector 4)

An #OF exception occurs as a result of executing an INTO instruction while the overflow bit in RFLAGS is set to 1 (RFLAGS.OF=1).

#OF cannot be disabled.

**Error Code Returned.** None.

**Program Restart.** #OF is a trap-type exception. The saved instruction pointer points to the instruction following the INTO instruction that caused the #OF.

### 8.2.6 #BR—Bound-Range Exception (Vector 5)

A #BR exception can occur as a result of executing the BOUND instruction. The BOUND instruction compares an array index (first operand) with the lower bounds and upper bounds of an array (second operand). If the array index is not within the array boundary, the #BR occurs.

#BR cannot be disabled.

**Error Code Returned.** None.

**Program Restart.** #BR is a fault-type exception. The saved instruction pointer points to the BOUND instruction that caused the #BR.

### 8.2.7 #UD—Invalid-Opcode Exception (Vector 6)

A #UD exception occurs when an attempt is made to execute an invalid or undefined opcode. The validity of an opcode often depends on the processor operating mode. A #UD occurs under the following conditions:

- Execution of any reserved or undefined opcode in any mode.
- Execution of the UD2 instruction.
- Use of the LOCK prefix on an instruction that cannot be locked.
- Use of the LOCK prefix on a lockable instruction with a non-memory target location.
- Execution of an instruction with an invalid-operand type.
- Execution of the SYSENTER or SYSEXIT instructions in long mode.
- Execution of any of the following instructions in 64-bit mode: AAA, AAD, AAM, AAS, BOUND, CALL (opcode 9A), DAA, DAS, DEC, INC, INTO, JMP (opcode EA), LDS, LES, POP (DS, ES, SS), POPA, PUSH (CS, DS, ES, SS), PUSHA, SALC.
- Execution of the ARPL, LAR, LLDT, LSL, LTR, SLDT, STR, VERR, or VERW instructions when protected mode is not enabled, or when virtual-8086 mode is enabled.
- Execution of any legacy SSE instruction when CR4.OSFXSR is cleared to 0. (For further information, see “FXSAVE/FXRSTOR Support (OSFXSR)” on page 50.

- Execution of any SSE instruction (uses YMM/XMM registers), or 64-bit media instruction (uses MMX™ registers) when CR0.EM = 1.
- Execution of any SSE floating-point instruction (uses YMM/XMM registers) that causes a numeric exception when CR4.OSXMMEXCPT = 0.
- Use of the DR4 or DR5 debug registers when CR4.DE = 1.
- Execution of RSM when not in SMM mode.

See the specific instruction description (in the other volumes) for additional information on invalid conditions.

#UD cannot be disabled.

**Error Code Returned.** None.

**Program Restart.** #UD is a fault-type exception. The saved instruction pointer points to the instruction that caused the #UD.

### 8.2.8 #NM—Device-Not-Available Exception (Vector 7)

A #NM exception occurs under any of the following conditions:

- An FWAIT/WAIT instruction is executed when CR0.MP=1 and CR0.TS=1.
- Any x87 instruction other than FWAIT is executed when CR0.EM=1.
- Any x87 instruction is executed when CR0.TS=1. The CR0.MP bit controls whether the FWAIT/WAIT instruction causes an #NM exception when TS=1.
- Any 128-bit or 64-bit media instruction when CR0.TS=1.

#NM can be enabled or disabled under the control of the CR0.MP, CR0.EM, and CR0.TS bits as described above. See “CR0 Register” on page 42 for more information on the CR0 bits used to control the #NM exception.

**Error Code Returned.** None.

**Program Restart.** #NM is a fault-type exception. The saved instruction pointer points to the instruction that caused the #NM.

### 8.2.9 #DF—Double-Fault Exception (Vector 8)

A #DF exception can occur when a second exception occurs during the handling of a prior (first) exception or interrupt handler.

Usually, the first and second exceptions can be handled sequentially without resulting in a #DF. In this case, the first exception is considered *benign*, as it does not harm the ability of the processor to handle the second exception.

In some cases, however, the first exception adversely affects the ability of the processor to handle the second exception. These exceptions contribute to the occurrence of a #DF, and are called *contributory*

exceptions. If a contributory exception is followed by another contributory exception, a double-fault exception occurs. Likewise, if a page fault is followed by another page fault or a contributory exception, a double-fault exception occurs.

Table 8-3 shows the conditions under which a #DF occurs. Page faults are either benign or contributory, and are listed separately. See the “Class” column in Table 8-2 on page 216 for information on whether an exception is benign or contributory.

**Table 8-3. Double-Fault Exception Conditions**

First Interrupting Event	Second Interrupting Event
Contributory Exceptions <ul style="list-style-type: none"> <li>• Divide-by-Zero-Error Exception</li> <li>• Invalid-TSS Exception</li> <li>• Segment-Not-Present Exception</li> <li>• Stack Exception</li> <li>• General-Protection Exception</li> </ul>	Invalid-TSS Exception Segment-Not-Present Exception Stack Exception General-Protection Exception
Page Fault Exception	Page Fault Exception Invalid-TSS Exception Segment-Not-Present Exception Stack Exception General-Protection Exception

If a third interrupting event occurs while transferring control to the #DF handler, the processor shuts down. Only an NMI, RESET, or INIT can restart the processor in this case. However, if the processor shuts down as it is executing an NMI handler, the processor can only be restarted with RESET or INIT.

#DF cannot be disabled.

**Error Code Returned.** Zero.

**Program Restart.** #DF is an abort-type exception. The saved instruction pointer is undefined, and the program cannot be restarted.

### 8.2.10 Coprocessor-Segment-Overrun Exception (Vector 9)

*This interrupt vector is reserved.* It is for a discontinued exception originally used by processors that supported external x87-instruction coprocessors. On those processors, the exception condition is caused by an invalid-segment or invalid-page access on an x87-instruction coprocessor-instruction operand. On current processors, this condition causes a general-protection exception to occur.

**Error Code Returned.** Not applicable.

**Program Restart.** Not applicable.

### 8.2.11 #TS—Invalid-TSS Exception (Vector 10)

A #TS exception occurs when an invalid reference is made to a segment selector as part of a task switch. A #TS also occurs during a privilege-changing control transfer (through a call gate or an interrupt gate), if a reference is made to an invalid stack-segment selector located in the TSS. Table 8-4 lists the conditions under which a #TS occurs and the error code returned by the exception mechanism.

#TS cannot be disabled.

**Error Code Returned.** See Table 8-4 for a list of error codes returned by the #TS exception.

**Program Restart.** #TS is a fault-type exception. If the exception occurs before loading the segment selectors from the TSS, the saved instruction pointer points to the instruction that caused the #TS. However, most #TS conditions occur due to errors with the loaded segment selectors. When an error is found with a segment selector, the hardware task-switch mechanism completes loading the new task state from the TSS, and then triggers the #TS exception mechanism. In this case, the saved instruction pointer points to the first instruction in the new task.

In long mode, a #TS cannot be caused by a task switch, because the hardware task-switch mechanism is disabled. A #TS occurs only as a result of a control transfer through a gate descriptor that results in an invalid stack-segment reference using an SS selector in the TSS. In this case, the saved instruction pointer always points to the control-transfer instruction that caused the #TS.

**Table 8-4. Invalid-TSS Exception Conditions**

Selector Reference	Error Condition	Error Code
Task-State Segment	TSS limit check on a task switch	TSS Selector Index
	TSS limit check on an inner-level stack pointer	
LDT Segment	LDT does not point to GDT	LDT Selector Index
	LDT reference outside GDT	
	GDT entry is not an LDT descriptor	
	LDT descriptor is not present	
Code Segment	CS reference outside GDT or LDT	CS Selector Index
	Privilege check (conforming DPL > CPL)	
	Privilege check (non-conforming DPL ≠ CPL)	
	Type check (CS not executable)	
Data Segment	Data segment reference outside GDT or LDT	DS, ES, FS or GS Selector Index
	Type check (data segment not readable)	
Stack Segment	SS reference outside GDT or LDT	SS Selector Index
	Privilege check (stack segment descriptor DPL ≠ CPL)	
	Privilege check (stack segment selector RPL ≠ CPL)	
	Type check (stack segment not writable)	

### 8.2.12 #NP—Segment-Not-Present Exception (Vector 11)

An #NP occurs when an attempt is made to load a segment or gate with a clear present bit, as described in the following situations:

- Using the MOV, POP, LDS, LES, LFS, or LGS instructions to load a segment selector (DS, ES, FS, and GS) that references a segment descriptor containing a clear present bit (descriptor.P=0).
- Far transfer to a CS that is not present.
- Referencing a gate descriptor containing a clear present bit.
- Referencing a TSS descriptor containing a clear present bit. This includes attempts to load the TSS descriptor using the LTR instruction.
- Attempting to load a descriptor containing a clear present bit into the LDTR using the LLDT instruction.
- Loading a segment selector (CS, DS, ES, FS, or GS) as part of a task switch, with the segment descriptor referenced by the segment selector having a clear present bit. In long mode, an #NP cannot be caused by a task switch, because the hardware task-switch mechanism is disabled.

When loading a stack-segment selector (SS) that references a descriptor with a clear present bit, a stack exception (#SS) occurs. For information on the #SS exception, see the next section, “#SS—Stack Exception (Vector 12).”

#NP cannot be disabled.

**Error Code Returned.** The segment-selector index of the segment descriptor causing the #NP exception.

**Program Restart.** #NP is a fault-type exception. In most cases, the saved instruction pointer points to the instruction that loaded the segment selector resulting in the #NP. See “Exceptions During a Task Switch” on page 230 for a description of the consequences when this exception occurs during a task switch.

### 8.2.13 #SS—Stack Exception (Vector 12)

An #SS exception can occur in the following situations:

- Implied stack references in which the stack address is not in canonical form. Implied stack references include all push and pop instructions, and any instruction using RSP or RBP as a base register.
- Attempting to load a stack-segment selector that references a segment descriptor containing a clear present bit (descriptor.P=0).
- Any stack access that fails the stack-limit check.

#SS cannot be disabled.

**Error Code Returned.** The error code depends on the cause of the #SS, as shown in Table 8-5 on page 224:

**Table 8-5. Stack Exception Error Codes**

Stack Exception Cause	Error Code
Stack-segment descriptor present bit is clear	SS Selector Index
Stack-limit violation	0
Stack reference using a non-canonical address	0

**Program Restart.** #SS is a fault-type exception. In most cases, the saved instruction pointer points to the instruction that caused the #SS. See “Exceptions During a Task Switch” on page 230 for a description of the consequences when this exception occurs during a task switch.

### 8.2.14 #GP—General-Protection Exception (Vector 13)

Table 8-6 describes the general situations that can cause a #GP exception. The table is not an exhaustive, detailed list of #GP conditions, but rather a guide to the situations that can cause a #GP. If an invalid use of an AMD64 architectural feature results in a #GP, the specific cause of the exception is described in detail in the section describing the architectural feature.

#GP cannot be disabled.

**Error Code Returned.** As shown in Table 8-6, a selector index is reported as the error code if the #GP is due to a segment-descriptor access. In all other cases, an error code of 0 is returned.

**Program Restart.** #GP is a fault-type exception. In most cases, the saved instruction pointer points to the instruction that caused the #GP. See “Exceptions During a Task Switch” on page 230 for a description of the consequences when this exception occurs during a task switch.

**Table 8-6. General-Protection Exception Conditions**

Error Condition	Error Code
Any segment privilege-check violation, while loading a segment register.	Selector Index
Any segment type-check violation, while loading a segment register.	
Loading a null selector into the CS, SS, or TR register.	
Accessing a gate-descriptor containing a null segment selector.	
Referencing an LDT descriptor or TSS descriptor located in the LDT.	
Attempting a control transfer to a busy TSS (except IRET).	
In 64-bit mode, loading a non-canonical base address into the GDTR or IDTR.	
In long mode, accessing a system or call-gate descriptor whose extended type field is not 0.	
In long mode, accessing a system descriptor containing a non-canonical base address.	
In long mode, accessing a gate descriptor containing a non-canonical offset.	
In long mode, accessing a gate descriptor that does not point to a 64-bit code segment.	
In long mode, accessing a 16-bit gate descriptor.	
In long mode, attempting a control transfer to a TSS or task gate.	



**Table 8-6. General-Protection Exception Conditions (continued)**

Error Condition	Error Code
Any segment limit-check or non-canonical address violation (except when using the SS register).	0
Accessing memory using a null segment register.	
Writing memory using a read-only segment register.	
Attempting to execute an SSE instruction specifying an unaligned memory operand.	
Attempting to execute code that is past the CS segment limit or at a non-canonical RIP.	
Executing a privileged instruction while CPL > 0.	
Executing an instruction that is more than 15 bytes long.	
Writing a 1 into any register field that is reserved, must be zero (MBZ).	
Using WRMSR to write a read-only MSR.	
Using WRMSR to write a non-canonical value into an MSR that must be canonical.	
Using WRMSR to set an invalid type encoding in an MTRR or the PAT MSR.	0
Enabling paging while protected mode is disabled.	
Setting CR0.NW=1 while CR0.CD=0.	
Any long-mode consistency-check violation.	

### 8.2.15 #PF—Page-Fault Exception (Vector 14)

A #PF exception can occur during a memory access in any of the following situations:

- A page-translation-table entry or physical page involved in translating the memory access is not present in physical memory. This is indicated by a cleared present bit (P=0) in the translation-table entry.
- An attempt is made by the processor to load the instruction TLB with a translation for a non-executable page.
- The memory access fails the paging-protection checks (user/supervisor, read/write, or both).
- A reserved bit in one of the page-translation-table entries is set to 1. A #PF occurs for this reason only when CR4.PSE=1 *or* CR4.PAE=1.

#PF cannot be disabled.

**CR2 Register.** The virtual (linear) address that caused the #PF is stored in the CR2 register. The legacy CR2 register is 32 bits long. The CR2 register in the AMD64 architecture is 64 bits long, as shown in Figure 8-1 on page 226. In AMD64 implementations, when either software or a page fault causes a write to the CR2 register, only the low-order 32 bits of CR2 are used in legacy mode; the processor clears the high-order 32 bits.

63

0



Page-Fault Virtual Address

**Figure 8-1. Control Register 2 (CR2)**

**Error Code Returned.** The page-fault error code is pushed onto the page-fault exception-handler stack. See “Page-Fault Error Code” on page 231 for a description of this error code.

**Program Restart.** #PF is a fault-type exception. In most cases, the saved instruction pointer points to the instruction that caused the #PF. See “Exceptions During a Task Switch” on page 230 for a description of what can happen if this exception occurs during a task switch.

### 8.2.16 #MF—x87 Floating-Point Exception-Pending (Vector 16)

The #MF exception is used to handle unmasked x87 floating-point exceptions. An #MF occurs when *all* of the following conditions are true:

- CR0.NE=1.
- An unmasked x87 floating-point exception is pending. This is indicated by an exception bit in the x87 floating-point status-word register being set to 1
- The corresponding mask bit in the x87 floating-point control-word register is cleared to 0.
- The FWAIT/WAIT instruction or any waiting floating-point instruction is executed.

If there is an exception mask bit (in the FPU control word) set, the exception is not reported. Instead, the x87-instruction unit responds in a default manner and execution proceeds normally.

The x87 floating-point exceptions reported by the #MF exception are (including mnemonics):

- IE—Invalid-operation exception (also called #I), which is either:
  - IE alone—Invalid arithmetic-operand exception (also called #IA), or
  - SF and IE together—x87 Stack-fault exception (also called #IS).
- DE—Denormalized-operand exception (also called #D).
- ZE—Zero-divide exception (also called #Z).
- OE—Overflow exception (also called #O).
- UE—Underflow exception (also called #U).
- PE—Precision exception (also called #P or inexact-result exception).

**Error Code Returned.** None. Exception information is provided by the x87 status-word register. See “x87 Floating-Point Programming” in Volume 1 for more information on using this register.

**Program Restart.** #MF is a fault-type exception. The #MF exception is not precise, because multiple instructions and exceptions can occur before the #MF handler is invoked. Also, the saved instruction

pointer does not point to the instruction that caused the exception resulting in the #MF. Instead, the saved instruction pointer points to the x87 floating-point instruction or FWAIT/WAIT instruction that is about to be executed when the #MF occurs. The address of the *last instruction* that caused an x87 floating-point exception is in the x87 instruction-pointer register. See “x87 Floating-Point Programming” in Volume 1 for information on accessing this register.

**Masking.** Each type of x87 floating-point exception can be masked by setting the appropriate bits in the x87 control-word register. See “x87 Floating-Point Programming” in Volume 1 for more information on using this register.

#MF can also be disabled by clearing the CR0.NE bit to 0. See “Numeric Error (NE) Bit” on page 44 for more information on using this bit.

### 8.2.17 #AC—Alignment-Check Exception (Vector 17)

An #AC exception occurs when an unaligned-memory data reference is performed while alignment checking is enabled.

After a processor reset, #AC exceptions are disabled. Software enables the #AC exception by setting the following register bits:

- CR0.AM=1.
- RFLAGS.AC=1.

When the above register bits are set, an #AC can occur only when CPL=3. #AC never occurs when CPL < 3.

Table 8-7 lists the data types and the alignment boundary required to *avoid* an #AC exception when the mechanism is enabled.

**Table 8-7. Data-Type Alignment**

Supported Data Type	Required Alignment (Byte Boundary)
Word	2
Doubleword	4
Quadword	8
Bit string	2, 4 or 8 (depends on operand size)
256-bit media	16
128-bit media	16
64-bit media	8
Segment selector	2
32-bit near pointer	4
32-bit far pointer	2
48-bit far pointer	4

**Table 8-7. Data-Type Alignment (continued)**

Supported Data Type	Required Alignment (Byte Boundary)
x87 Floating-point single-precision	4
x87 Floating-point double-precision	8
x87 Floating-point extended-precision	8
x87 Floating-point save areas	2 or 4 (depends on operand size)

**Error Code Returned.** Zero.

**Program Restart.** #AC is a fault-type exception. The saved instruction pointer points to the instruction that caused the #AC.

### 8.2.18 #MC—Machine-Check Exception (Vector 18)

The #MC exception is model specific. Processor implementations are not required to support the #MC exception, and those implementations that do support #MC can vary in how the #MC exception mechanism works.

The exception is enabled by setting CR4.MCE to 1. The machine-check architecture can include model-specific masking for controlling the reporting of some errors. Refer to Chapter 9, “Machine Check Architecture,” for more information.

**Error Code Returned.** None. Error information is provided by model-specific registers (MSRs) defined by the machine-check architecture.

**Program Restart.** #MC is an abort-type exception. There is no reliable way to restart the program. If the EIPV flag (EIP valid) is set in the MCG\_Status MSR, the saved CS and rIP point to the instruction that caused the error. If EIP is clear, the CS:rIP of the instruction causing the failure is not known or the machine check is not related to a specific instruction.

### 8.2.19 #XF—SIMD Floating-Point Exception (Vector 19)

The #XF exception is used to handle unmasked SSE floating-point exceptions. A #XF exception occurs when all of the following conditions are true:

- A SSE floating-point exception occurs. The exception causes the processor to set the appropriate exception-status bit in the MXCSR register to 1.
- The exception-mask bit in the MXCSR that corresponds to the SSE floating-point exception is clear (=0).
- CR4.OSXMMEXCPT=1, indicating that the operating system supports handling of SSE floating-point exceptions.

The exception-mask bits are used by software to specify the handling of SSE floating-point exceptions. When the corresponding mask bit is cleared to 0, an exception occurs under the control of

the CR4.OSXMMEXCPT bit. However, if the mask bit is set to 1, the SSE floating-point unit responds in a default manner and execution proceeds normally.

The CR4.OSXMMEXCPT bit specifies the interrupt vector to be taken when an unmasked SSE floating-point exception occurs. When CR4.OSXMMEXCPT=1, the #XF interrupt vector is taken when an exception occurs. When CR4.OSXMMEXCPT=0, the #UD (undefined opcode) interrupt vector is taken when an exception occurs.

The SSE floating-point exceptions reported by the #XF exception are (including mnemonics):

- IE—Invalid-operation exception (also called #I).
- DE—Denormalized-operand exception (also called #D).
- ZE—Zero-divide exception (also called #Z).
- OE—Overflow exception (also called #O).
- UE—Underflow exception (also called #U).
- PE—Precision exception (also called #P or inexact-result exception).

Each type of SSE floating-point exception can be masked by setting the appropriate bits in the MXCSR register. #XF can also be disabled by clearing the CR4.OSXMMEXCPT bit to 0.

**Error Code Returned.** None. Exception information is provided by the SSE floating-point MXCSR register. See “Instruction Reference” in Volume 4 for more information on using this register.

**Program Restart.** #XF is a fault-type exception. Unlike the #MF exception, the #XF exception is precise. The saved instruction pointer points to the instruction that caused the #XF.

### 8.2.20 #SX—Security Exception (Vector 30)

The #SX exception is generated by security-sensitive events under SVM. See “Security Exception (#SX)” on page 503 for details.

### 8.2.21 User-Defined Interrupts (Vectors 32–255)

User-defined interrupts can be initiated either by system logic or software. They occur when:

- System logic signals an external interrupt request to the processor. The signaling mechanism and the method of communicating the interrupt vector to the processor are implementation dependent.
- Software executes an INT $n$  instruction. The INT $n$  instruction operand provides the interrupt vector number.

Both methods can be used to initiate an interrupt into vectors 0 through 255. However, because vectors 0 through 31 are defined or reserved by the AMD64 architecture, software should not use vectors in this range for purposes other than their defined use.

**Error Code Returned.** None.

**Program Restart.** The saved instruction pointer depends on the interrupt source:

- External interrupts are recognized on instruction boundaries. The saved instruction pointer points to the instruction immediately following the boundary where the external interrupt was recognized.
- If the interrupt occurs as a result of executing the  $INTn$  instruction, the saved instruction pointer points to the instruction after the  $INTn$ .

**Masking.** The ability to mask user-defined interrupts depends on the interrupt source:

- External interrupts can be masked using the  $rFLAGS.IF$  bit. Setting  $rFLAGS.IF$  to 1 enables external interrupts, while clearing  $rFLAGS.IF$  to 0 inhibits them.
- Software interrupts (initiated by the  $INTn$  instruction) cannot be disabled.

## 8.3 Exceptions During a Task Switch

An exception can occur during a task switch while loading a segment selector. Page faults can also occur when accessing a TSS. In these cases, the hardware task-switch mechanism completes loading the new task state from the TSS, and then triggers the appropriate exception mechanism. No other checks are performed. When this happens, the saved instruction pointer points to the first instruction in the new task.

In long mode, an exception cannot occur during a task switch, because the hardware task-switch mechanism is disabled.

## 8.4 Error Codes

The processor exception-handling mechanism reports error and status information for some exceptions using an error code. The error code is pushed onto the stack by the exception-mechanism during the control transfer into the exception handler. The error code has two formats: a selector format for most error-reporting exceptions, and a page-fault format for page faults. These formats are described in the following sections.

### 8.4.1 Selector-Error Code

Figure 8-2 shows the format of the selector-error code.

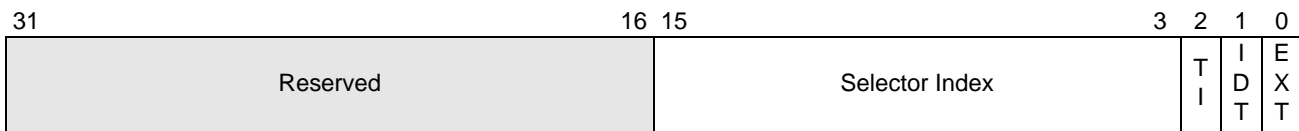

**Figure 8-2. Selector Error Code**

The information reported by the selector-error code includes:

- *EXT*—Bit 0. If this bit is set to 1, the exception source is external to the processor. If cleared to 0, the exception source is internal to the processor.
- *IDT*—Bit 1. If this bit is set to 1, the error-code selector-index field references a gate descriptor located in the interrupt-descriptor table (IDT). If cleared to 0, the selector-index field references a descriptor in either the global-descriptor table (GDT) or local-descriptor table (LDT), as indicated by the *TI* bit.
- *TI*—Bit 2. If this bit is set to 1, the error-code selector-index field references a descriptor in the LDT. If cleared to 0, the selector-index field references a descriptor in the GDT. The *TI* bit is relevant only when the *IDT* bit is cleared to 0.
- *Selector Index*—Bits 15:3. The selector-index field specifies the index into either the GDT, LDT, or IDT, as specified by the *IDT* and *TI* bits.

Some exceptions return a zero in the selector-error code.

### 8.4.2 Page-Fault Error Code

Figure 8-3 shows the format of the page-fault error code.



**Figure 8-3. Page-Fault Error Code**

The information reported by the page-fault error code includes:

- *P*—Bit 0. If this bit is cleared to 0, the page fault was caused by a not-present page. If this bit is set to 1, the page fault was caused by a page-protection violation.
- *R/W*—Bit 1. If this bit is cleared to 0, the access that caused the page fault is a memory read. If this bit is set to 1, the memory access that caused the page fault was a write. This bit does not necessarily indicate the cause of the page fault was a read or write violation.
- *U/S*—Bit 2. If this bit is cleared to 0, an access in supervisor mode (CPL=0, 1, or 2) caused the page fault. If this bit is set to 1, an access in user mode (CPL=3) caused the page fault. This bit does not necessarily indicate the cause of the page fault was a privilege violation.
- *RSV*—Bit 3. If this bit is set to 1, the page fault is a result of the processor reading a 1 from a reserved field within a page-translation-table entry. This type of page fault occurs only when CR4.PSE=1 or CR4.PAE=1. If this bit is cleared to 0, the page fault was not caused by the processor reading a 1 from a reserved field.
- *I/D*—Bit 4. If this bit is set to 1, it indicates that the access that caused the page fault was an instruction fetch. Otherwise, this bit is cleared to 0. This bit is only defined if no-execute feature is enabled (EFER.NXE=1 && CR4.PAE=1).

## 8.5 Priorities

To allow for consistent handling of multiple-interrupt conditions, simultaneous interrupts are prioritized by the processor. The AMD64 architecture defines priorities between groups of interrupts, and interrupt prioritization within a group is implementation dependent. Table 8-8 shows the interrupt priorities defined by the AMD64 architecture.

When simultaneous interrupts occur, the processor transfers control to the highest-priority interrupt handler. Lower-priority interrupts from external sources are held pending by the processor, and they are handled after the higher-priority interrupt is handled. Lower-priority interrupts that result from internal sources are discarded. Those interrupts reoccur when the high-priority interrupt handler completes and transfers control back to the interrupted instruction. Software interrupts are discarded as well, and reoccur when the software-interrupt instruction is restarted.

**Table 8-8. Simultaneous Interrupt Priorities**

Interrupt Priority	Interrupt Condition	Interrupt Vector
(High) 0	Processor Reset	—
	Machine-Check Exception	18
1	External Processor Initialization (INIT)	—
	SMI Interrupt	
	External Clock Stop (Stpclk)	
2	Data, and I/O Breakpoint (Debug Register)	1
	Single-Step Execution Instruction Trap (rFLAGS.TF=1)	
3	Non-Maskable Interrupt	2
4	Maskable External Interrupt (INTR)	32–255
5	Instruction Breakpoint (Debug Register)	1
	Code-Segment-Limit Violation	13
	Instruction-Fetch Page Fault	14
6	Invalid Opcode Exception	6
	Device-Not-Available Exception	7
	Instruction-Length Violation (> 15 Bytes)	13



**Table 8-8. Simultaneous Interrupt Priorities (continued)**

Interrupt Priority	Interrupt Condition	Interrupt Vector
7	Divide-by-zero Exception	0
	Invalid-TSS Exception	10
	Segment-Not-Present Exception	11
	Stack Exception	12
	General-Protection Exception	13
	Data-Access Page Fault	14
	Floating-Point Exception-Pending Exception	16
	Alignment-Check Exception	17
	SIMD Floating-Point Exception	19

### 8.5.1 Floating-Point Exception Priorities

Floating-point exceptions (SSE and x87 floating-point) can be handled in one of two ways:

- Unmasked exceptions are reported in the appropriate floating-point status register, and a software-interrupt handler is invoked. See “#MF—x87 Floating-Point Exception-Pending (Vector 16)” on page 226 and “#XF—SIMD Floating-Point Exception (Vector 19)” on page 229 for more information on the floating-point interrupts.
- Masked exceptions are also reported in the appropriate floating-point status register. Instead of transferring control to an interrupt handler, however, the processor handles the exception in a default manner and execution proceeds.

If the processor detects more than one exception while executing a single floating-point instruction, it prioritizes the exceptions in a predictable manner. When responding in a default manner to masked exceptions, it is possible that the processor acts only on the high-priority exception and ignores lower-priority exceptions. In the case of vector (SIMD) floating-point instructions, priorities are set on sub-operations, not across all operations. For example, if the processor detects and acts on a QNaN operand in one sub-operation, the processor can still detect and act on a denormal operand in another sub-operation.

When reporting SSE floating-point exceptions before taking an interrupt or handling them in a default manner, the processor first classifies the exceptions as follows:

- *Input exceptions* include SNaN operand (#I), invalid operation (#I), denormal operand (#D), or zero-divide (#Z). Using a NaN operand with a maximum, minimum, compare, or convert instruction is also considered an input exception.
- *Output exceptions* include numeric overflow (#O), numeric underflow (#U), and precision (#P).

Using the above classification, the processor applies the following procedure to report the exceptions:

1. The exceptions for all sub-operations are prioritized.
2. The exception conditions for all sub-operations are logically ORed together to form a single set of exceptions covering all operations. For example, if two sub-operations produce a denormal result, only one denormal exception is reported.
3. If the set of exceptions includes any *unmasked* input exceptions, all input exceptions are reported in MCXSR, and no output exceptions are reported. Otherwise, all input and output exceptions are reported in MCXSR.
4. If any exceptions are unmasked, control is transferred to the appropriate interrupt handler.

Table 8-9 on page 234 lists the priorities for simultaneous floating-point exceptions.

**Table 8-9. Simultaneous Floating-Point Exception Priorities**

Exception Priority	Exception Condition	
(High) 0	SNaN Operand	#I
	NaN Operand of Maximum, Minimum, Compare, and Convert Instructions (Vector Floating-Point)	
	Stack Overflow (x87 Floating-Point)	
	Stack Underflow (x87 Floating-Point)	
1	QNaN Operand	—
2	Invalid Operation (Remaining Conditions)	#I
	Zero Divide	#Z
3	Denormal Operand	#D
4	Numeric Overflow	#O
	Numeric Underflow	#U
5 (Low)	Precision	#P

### 8.5.2 External Interrupt Priorities

The AMD64 architecture allows software to define up to 15 external interrupt-priority classes. Priority classes are numbered from 1 to 15, with priority-class 1 being the lowest and priority-class 15 the highest. The organization of these priority classes is implementation dependent. A typical method is to use the upper four bits of the interrupt vector number to define the priority. Thus, interrupt vector 53h has a priority of 5 and interrupt vector 37h has a priority of 3.

A new control register (CR8) is introduced by the AMD64 architecture for managing priority classes. This register, called the *task-priority register* (TPR), uses its four low-order bits to specify a task priority. The remaining 60 bits are reserved and must be written with zeros. Figure 8-4 shows the format of the TPR.

The TPR is available only in 64-bit mode.

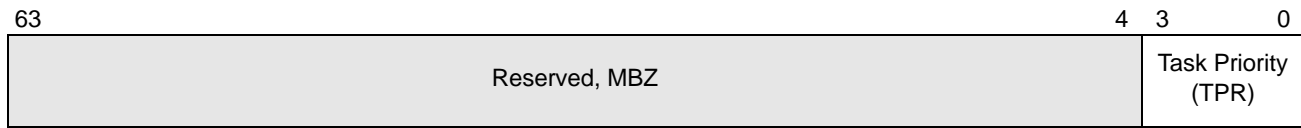

**Figure 8-4. Task Priority Register (CR8)**

System software can use the TPR register to temporarily block low-priority interrupts from interrupting a high-priority task. This is accomplished by loading TPR with a value corresponding to the highest-priority interrupt that is to be blocked. For example, loading TPR with a value of 9 (1001b) blocks all interrupts with a priority class of 9 or less, while allowing all interrupts with a priority class of 10 or more to be recognized. Loading TPR with 0 enables all external interrupts. Loading TPR with 15 (1111b) disables all external interrupts. The TPR is cleared to 0 on reset.

System software reads and writes the TPR using a MOV CR8 instruction. The MOV CR8 instruction requires a privilege level of 0. Programs running at any other privilege level cannot read or write the TPR, and an attempt to do so results in a general-protection exception (#GP).

A serializing instruction is not required after loading the TPR, because a new priority level is established when the MOV instruction completes execution. For example, assume two sequential TPR loads are performed, in which a low value is first loaded into TPR and immediately followed by a load of a higher value. Any pending, lower-priority interrupt enabled by the first MOV CR8 is recognized between the two MOVs.

The TPR is an architectural abstraction of the interrupt controller (IC), which prioritizes and manages external interrupt delivery to the processor. The IC can be an external system device, or it can be integrated on the chip like the local advanced programmable interrupt controller (APIC). Typically, the IC contains a priority mechanism similar, if not identical to, the TPR. The IC, however, is implementation dependent, and the underlying priority mechanisms are subject to change. The TPR, by contrast, is part of the AMD64 architecture.

**Effect of IC on TPR.** The features of the implementation-specific IC can impact the operation of the TPR. For example, the TPR might affect interrupt delivery only if the IC is enabled. Also, the mapping of an external interrupt to a specific interrupt priority is an implementation-specific behavior of the IC.

## 8.6 Real-Mode Interrupt Control Transfers

In real mode, the IDT is a table of 4-byte entries, one entry for each of the 256 possible interrupts implemented by the system. The real mode IDT is often referred to as an *interrupt vector table*, or IVT. Table entries contain a far pointer (CS:IP pair) to an exception or interrupt handler. The base of the IDT is stored in the IDTR register, which is loaded with a value of 00h during a processor reset. Figure 8-5 on page 236 shows how the real-mode interrupt handler is located by the interrupt mechanism.

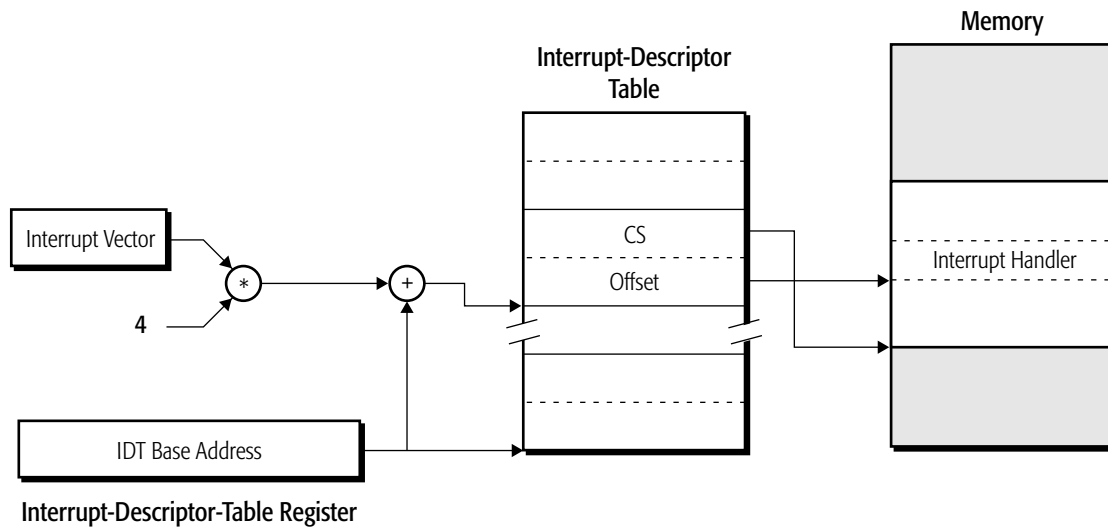
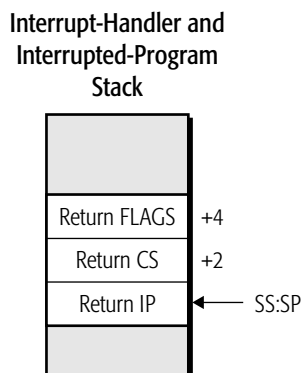

**Figure 8-5. Real-Mode Interrupt Control Transfer**

When an exception or interrupt occurs in real mode, the processor performs the following:

1. Pushes the FLAGS register (EFLAGS[15:0]) onto the stack.
2. Clears EFLAGS.IF to 0 and EFLAGS.TF to 0.
3. Saves the CS register and IP register (RIP[15:0]) by pushing them onto the stack.
4. Locates the interrupt-handler pointer (CS:IP) in the IDT by scaling the interrupt vector by four and adding the result to the value in the IDTR.
5. Transfers control to the interrupt handler referenced by the CS:IP in the IDT.

Figure 8-6 on page 237 shows the stack after control is transferred to the interrupt handler in real mode.



**Figure 8-6. Stack After Interrupt in Real Mode**

An IRET instruction is used to return to the interrupted program. When an IRET is executed, the processor performs the following:

1. Pops the saved CS value off the stack and into the CS register. The saved IP value is popped into RIP[15:0].
2. Pops the FLAGS value off of the stack and into EFLAGS[15:0].
3. Execution begins at the saved CS.IP location.

## 8.7 Legacy Protected-Mode Interrupt Control Transfers

In protected mode, the interrupt mechanism transfers control to an exception or interrupt handler through gate descriptors. In protected mode, the IDT is a table of 8-byte gate entries, one for each of the 256 possible interrupt vectors implemented by the system. Three gate types are allowed in the IDT:

- Interrupt gates.
- Trap gates.
- Task gates.

If a reference is made to any other descriptor type in the IDT, a general-protection exception (#GP) occurs.

Interrupt-gate control transfers are similar to CALLs and JMPs through call gates. The interrupt mechanism uses gates (interrupt, trap, and task) to establish protected entry-points into the exception and interrupt handlers.

The remainder of this chapter discusses control transfers through interrupt gates and trap gates. If the gate descriptor in the IDT is a task gate, a TSS-segment selector is referenced, and a task switch

occurs. See Chapter 12, “Task Management,” for more information on the hardware task-switch mechanism.

### 8.7.1 Locating the Interrupt Handler

When an exception or interrupt occurs, the processor scales the interrupt vector number by eight and uses the result as an offset into the IDT. If the gate descriptor referenced by the IDT offset is an interrupt gate or a trap gate, it contains a segment-selector and segment-offset field (see “Legacy Segment Descriptors” on page 80 for a detailed description of the gate-descriptor format and fields). These two fields perform the same function as the pointer operand in a far control-transfer instruction. The gate-descriptor segment-selector field points to the target code-segment descriptor located in either the GDT or LDT. The gate-descriptor segment-offset field is the instruction-pointer offset into the interrupt-handler code segment. The code-segment base taken from the code-segment descriptor is added to the gate-descriptor segment-offset field to create the interrupt-handler virtual address (linear address).

Figure 8-7 on page 239 shows how the protected-mode interrupt handler is located by the interrupt mechanism.

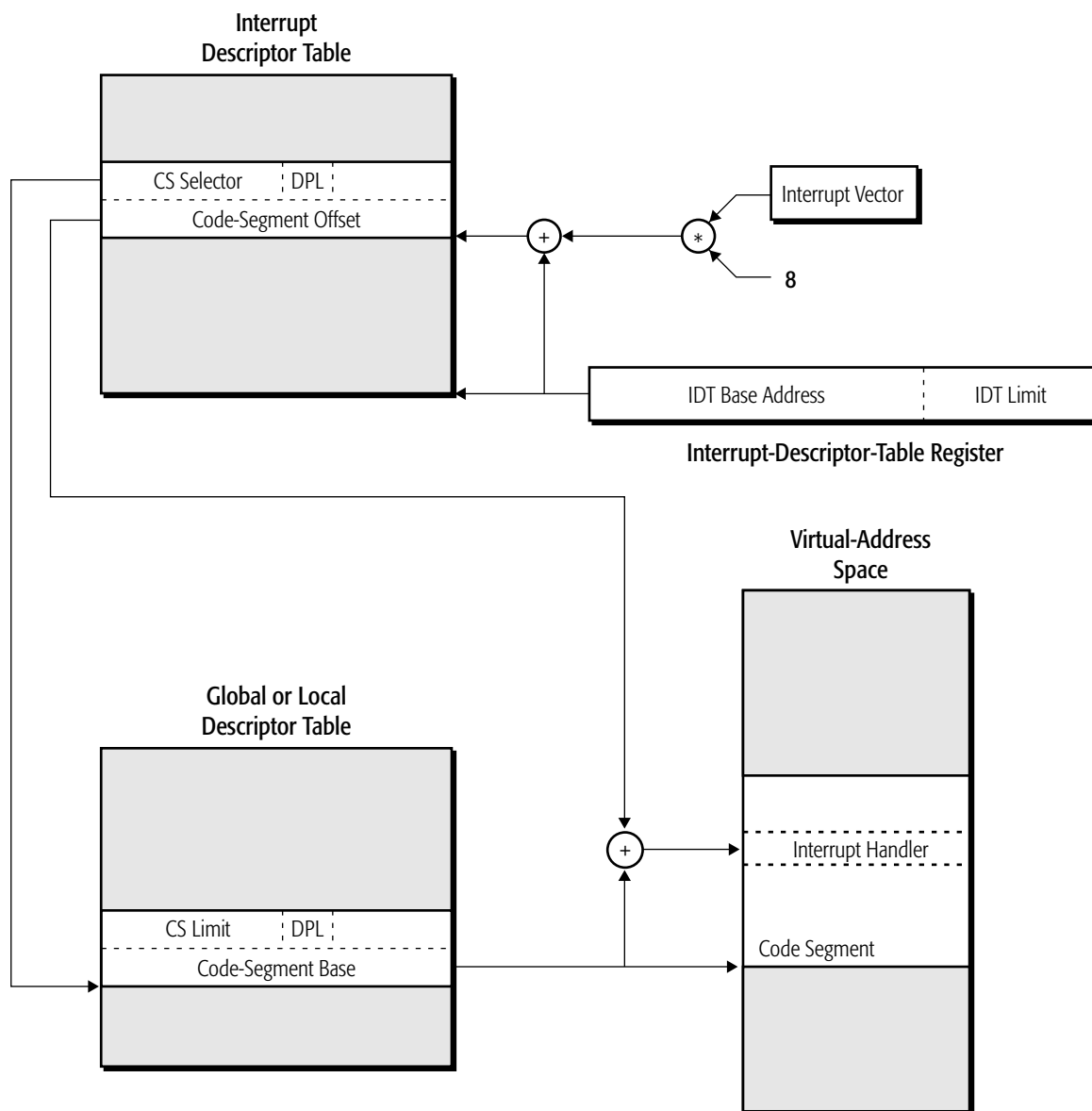

**Figure 8-7. Protected-Mode Interrupt Control Transfer**

### 8.7.2 Interrupt To Same Privilege

When a control transfer to an exception or interrupt handler at the same privilege level occurs (through an interrupt gate or a trap gate), the processor performs the following:

1. Pushes the EFLAGS register onto the stack.
2. Clears the TF, NT, RF, and VM bits in EFLAGS to 0.

3. The processor handles EFLAGS.IF based on the gate-descriptor type:
  - If the gate descriptor is an interrupt gate, EFLAGS.IF is cleared to 0.
  - If the gate descriptor is a trap gate, EFLAGS.IF is not modified.
4. Saves the return CS register and EIP register (RIP[31:0]) by pushing them onto the stack. The CS value is padded with two bytes to form a doubleword.
5. If the interrupt has an associated error code, the error code is pushed onto the stack.
6. The CS register is loaded from the segment-selector field in the gate descriptor, and the EIP is loaded from the offset field in the gate descriptor.
7. The interrupt handler begins executing with the instruction referenced by new CS:EIP.

Figure 8-8 shows the stack after control is transferred to the interrupt handler.

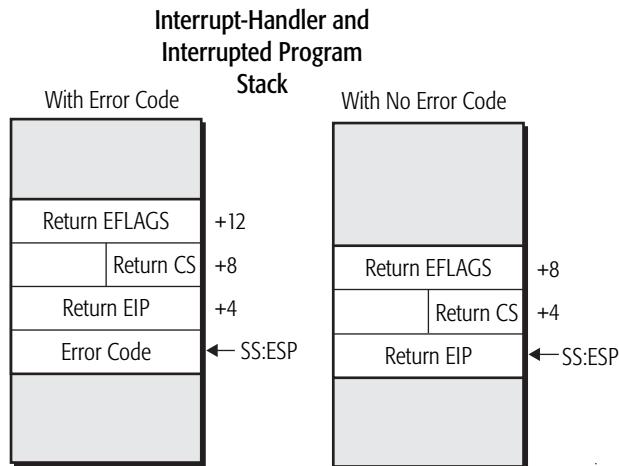

**Figure 8-8. Stack After Interrupt to Same Privilege Level**

### 8.7.3 Interrupt To Higher Privilege

When a control transfer to an exception or interrupt handler running at a higher privilege occurs (numerically lower CPL value), the processor performs a stack switch using the following steps:

1. The target CPL is read by the processor from the target code-segment DPL and used as an index into the TSS for selecting the new stack pointer (SS:ESP). For example, if the target CPL is 1, the processor selects the SS:ESP for privilege-level 1 from the TSS.
2. Pushes the return stack pointer (old SS:ESP) onto the new stack. The SS value is padded with two bytes to form a doubleword.
3. Pushes the EFLAGS register onto the new stack.
4. Clears the following EFLAGS bits to 0: TF, NT, RF, and VM.



5. The processor handles the EFLAGS.IF bit based on the gate-descriptor type:
  - If the gate descriptor is an interrupt gate, EFLAGS.IF is cleared to 0.
  - If the gate descriptor is a trap gate, EFLAGS.IF is not modified.
6. Saves the return-address pointer (CS:EIP) by pushing it onto the stack. The CS value is padded with two bytes to form a doubleword.
7. If the interrupt vector number has an error code associated with it, the error code is pushed onto the stack.
8. The CS register is loaded from the segment-selector field in the gate descriptor, and the EIP is loaded from the offset field in the gate descriptor.
9. The interrupt handler begins executing with the instruction referenced by new CS:EIP.

Figure 8-9 shows the new stack after control is transferred to the interrupt handler.

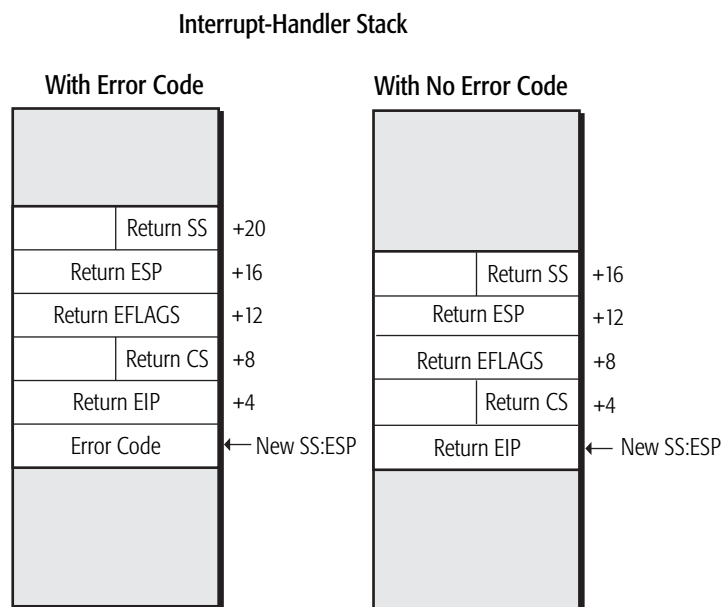

**Figure 8-9. Stack After Interrupt to Higher Privilege**

#### 8.7.4 Privilege Checks

Before loading the CS register with the interrupt-handler code-segment selector (located in the gate descriptor), the processor performs privilege checks similar to those performed on call gates. The checks are performed when either conforming or nonconforming interrupt handlers are referenced:

1. The processor reads the gate DPL from the interrupt-gate or trap-gate descriptor. The gate DPL is the *minimum privilege-level* (numerically-highest value) needed by a program to access the gate. The processor compares the CPL with the gate DPL. The CPL must be numerically *less-than or equal-to* the gate DPL for this check to pass.

2. The processor compares the CPL with the interrupt-handler code-segment DPL. For this check to pass, the CPL must be numerically *greater-than or equal-to* the code-segment DPL. This check prevents control transfers to less-privileged interrupt handlers.

Unlike call gates, no RPL comparison takes place. This is because the gate descriptor is referenced in the IDT using the interrupt vector number rather than a selector, and no RPL field exists in the interrupt vector number.

Exception and interrupt handlers should be made reachable from software running at any privilege level that requires them. If the gate DPL value is too low (requiring more privilege), or the interrupt-handler code-segment DPL is too high (runs at lower privilege), the interrupt control transfer can fail the privilege checks. Setting the gate DPL=3 and interrupt-handler code-segment DPL=0 makes the exception handler or interrupt handler reachable from any privilege level.

Figure 8-10 on page 243 shows two examples of interrupt privilege checks. In Example 1, both privilege checks pass:

- The interrupt-gate DPL is at the lowest privilege (3), which means that software running at any privilege level (CPL) can access the interrupt gate.
- The interrupt-handler code segment is at the highest-privilege level, as indicated by DPL=0. This means software running at any privilege can enter the interrupt handler through the interrupt gate.

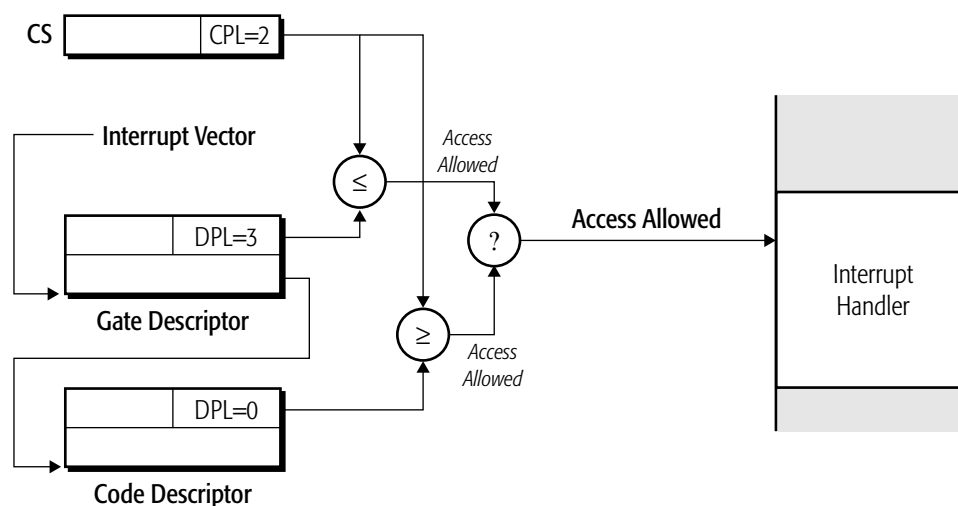

Example 1: Privilege Check Passes

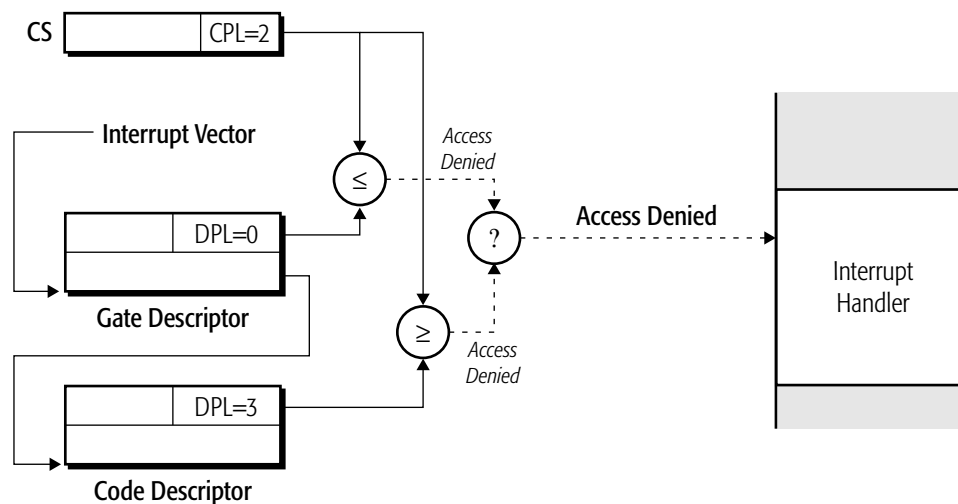

Example 2: Privilege Check Fails

**Figure 8-10. Privilege-Check Examples for Interrupts**

In Example 2, both privilege checks fail:

- The interrupt-gate DPL specifies that only software running at privilege-level 0 can access the gate. The current program does not have a high enough privilege level to access the interrupt gate, since its CPL is set at 2.

- The interrupt handler has a lower privilege (DPL=3) than the currently-running software (CPL=2). Transitions from more-privileged software to less-privileged software are not allowed, so this privilege check fails as well.

Although both privilege checks fail, only one such failure is required to deny access to the interrupt handler.

### 8.7.5 Returning From Interrupt Procedures

A return to an interrupted program should be performed using the IRET instruction. An IRET is a far return to a different code segment, with or without a change in privilege level. The actions of an IRET in both cases are described in the following sections.

**IRET, Same Privilege.** Before performing the IRET, the stack pointer must point to the return EIP. If there was an error code pushed onto the stack as a result of the exception or interrupt, that error code should have been popped off the stack earlier by the handler. The IRET reverses the actions of the interrupt mechanism:

1. Pops the return pointer off of the stack, loading both the CS register and EIP register (RIP[31:0]) with the saved values. The return code-segment RPL is read by the processor from the CS value stored on the stack to determine that an equal-privilege control transfer is occurring.
2. Pops the saved EFLAGS image off of the stack and into the EFLAGS register.
3. Transfers control to the return program at the target CS:EIP.

**IRET, Less Privilege.** If an IRET changes privilege levels, the return program must be at a lower privilege than the interrupt handler. The IRET in this case causes a stack switch to occur:

1. The return pointer is popped off of the stack, loading both the CS register and EIP register (RIP[31:0]) with the saved values. The return code-segment RPL is read by the processor from the CS value stored on the stack to determine that a lower-privilege control transfer is occurring.
2. The saved EFLAGS image is popped off of the stack and loaded into the EFLAGS register.
3. The return-program stack pointer is popped off of the stack, loading both the SS register and ESP register (RSP[31:0]) with the saved values.
4. Control is transferred to the return program at the target CS:EIP.

## 8.8 Virtual-8086 Mode Interrupt Control Transfers

This section describes interrupt control transfers as they relate to virtual-8086 mode. Virtual-8086 mode is not supported by long mode. Therefore, the control-transfer mechanism described here is not applicable to long mode.

When a software interrupt occurs (not external interrupts, INT1, or INT3) while the processor is running in virtual-8086 mode (EFLAGS.VM=1), the control transfer that occurs depends on three system controls:

- *EFLAGS.IOPL*—This field controls interrupt handling based on the CPL. See “I/O Privilege Level Field (IOPL) Field” on page 53 for more information on this field.  
Setting  $IOPL < 3$  redirects the interrupt to the general-protection exception (#GP) handler.
- *CR4.VME*—This bit enables virtual-mode extensions. See “Virtual-8086 Mode Extensions (VME)” on page 48 for more information on this bit.
- *TSS Interrupt-Redirection Bitmap*—The TSS interrupt-redirection bitmap contains 256 bits, one for each possible  $INTn$  vector (software interrupt). When  $CR4.VME=1$ , the bitmap is used by the processor to direct interrupts to the handler provided by the currently-running 8086 program (bitmap entry is 0), or to the protected-mode operating-system interrupt handler (bitmap entry is 1). See “Legacy Task-State Segment” on page 333 for information on the location of this field within the TSS.

If  $IOPL < 3$ ,  $CR4.VME=1$ , and the corresponding interrupt redirection bitmap entry is 0, the processor uses the virtual-interrupt mechanism. See “Virtual Interrupts” on page 253 for more information on this mechanism.

Table 8-10 summarizes the actions of the above system controls on interrupts taken when the processor is running in virtual-8086 mode.

**Table 8-10. Virtual-8086 Mode Interrupt Mechanisms**

<b>EFLAGS.IOPL</b>	<b>CR4.VME</b>	<b>TSS Interrupt Redirection Bitmap Entry</b>	<b>Interrupt Mechanism</b>
0, 1, or 2	0	—	General-Protection Exception
	1	1	
	1	0	Virtual Interrupt
3	0	—	Protected-Mode Handler
	1	1	
	1	0	Virtual 8086 Handler

### 8.8.1 Protected-Mode Handler Control Transfer

Control transfers to protected-mode handlers from virtual-8086 mode differ from standard protected-mode transfers in several ways. The processor follows these steps in making the control transfer:

1. Reads the  $CPL=0$  stack pointer ( $SS:ESP$ ) from the TSS.
2. Pushes the GS, FS, DS, and ES selector registers onto the stack. Each push is padded with two bytes to form a doubleword.
3. Clears the GS, FS, DS, and ES selector registers to 0. This places a null selector in each of the four registers
4. Pushes the return stack pointer (old  $SS:ESP$ ) onto the new stack. The SS value is padded with two bytes to form a doubleword.

5. Pushes the EFLAGS register onto the new stack.
6. Clears the following EFLAGS bits to 0: TF, NT, RF, and VM.
7. Handles EFLAGS.IF based on the gate-descriptor type:
  - If the gate descriptor is an interrupt gate, EFLAGS.IF is cleared to 0.
  - If the gate descriptor is a trap gate, EFLAGS.IF is not modified.
8. Pushes the return-address pointer (CS:EIP) onto the stack. The CS value is padded with two bytes to form a doubleword.
9. If the interrupt has an associated error code, pushes the error code onto the stack.
10. Loads the segment-selector field from the gate descriptor into the CS register, and loads the offset field from the gate descriptor into the EIP register.
11. Begins execution of the interrupt handler with the instruction referenced by the new CS:EIP.

Figure 8-11 shows the new stack after control is transferred to the interrupt handler with an error code.

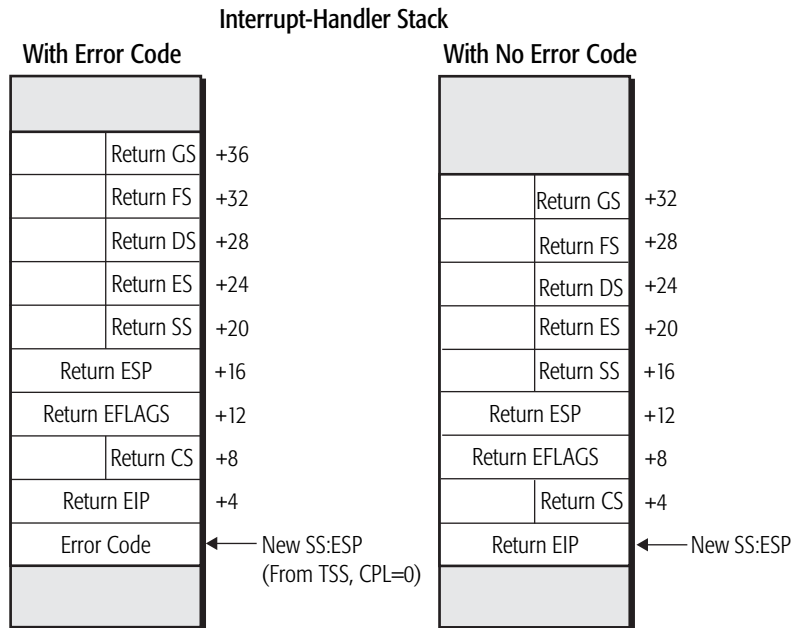

**Figure 8-11. Stack After Virtual-8086 Mode Interrupt to Protected Mode**

An IRET from privileged protected-mode software (CPL=0) to virtual-8086 mode reverses the stack-build process. After the return pointer, EFLAGS, and return stack-pointer are restored, the processor restores the ES, DS, FS, and GS registers by popping their values off the stack.

### 8.8.2 Virtual-8086 Handler Control Transfer

When a control transfer to an 8086 handler occurs from virtual-8086 mode, the processor creates an interrupt-handler stack identical to that created when an interrupt occurs in real mode (see Figure 8-6 on page 237). The processor performs the following actions during a control transfer:

1. Pushes the FLAGS register (EFLAGS[15:0]) onto the stack.
2. Clears the EFLAGS.IF and EFLAGS.RF bits to 0.
3. Saves the CS register and IP register (RIP[15:0]) by pushing them onto the stack.
4. Locates the interrupt-handler pointer (CS:IP) in the 8086 IDT by scaling the interrupt vector by four and adding the result to the virtual (linear) address 0. The value in the IDTR is not used.
5. Transfers control to the interrupt handler referenced by the CS:IP in the IDT.

An IRET from the 8086 handler back to virtual-8086 mode reverses the stack-build process.

## 8.9 Long-Mode Interrupt Control Transfers

The long-mode architecture expands the legacy interrupt-mechanism to support 64-bit operating systems and applications. These changes include:

- All interrupt handlers are 64-bit code and operate in 64-bit mode.
- The size of an interrupt-stack push is fixed at 64 bits (8 bytes).
- The interrupt-stack frame is aligned on a 16-byte boundary.
- The stack pointer, SS:RSP, is pushed unconditionally on interrupts, rather than conditionally based on a change in CPL.
- The SS selector register is loaded with a null selector as a result of an interrupt, if the CPL changes.
- The IRET instruction behavior changes, to unconditionally pop SS:RSP, allowing a null SS to be popped.
- A new interrupt stack-switch mechanism, called the interrupt-stack table or IST, is introduced.

### 8.9.1 Interrupt Gates and Trap Gates

Only long-mode interrupt and trap gates can be referenced in long mode (64-bit mode and compatibility mode). The legacy 32-bit interrupt-gate and 32-bit trap-gate types (0Eh and 0Fh, as described in “System Descriptors” on page 90) are redefined in long mode as 64-bit interrupt-gate and 64-bit trap-gate types. 32-bit and 16-bit interrupt-gate and trap-gate types do not exist in long mode, and software is prohibited from using task gates. If a reference is made to any gate other than a 64-bit interrupt gate or a 64-bit trap gate, a general-protection exception (#GP) occurs.

The long-mode gate types are 16 bytes (128 bits) long. They are an extension of the legacy-mode gate types, allowing a full 64-bit segment offset to be stored in the descriptor. See “Legacy Segment Descriptors” on page 80 for a detailed description of the gate-descriptor format and fields.

## 8.9.2 Locating the Interrupt Handler

When an interrupt occurs in long mode, the processor multiplies the interrupt vector number by 16 and uses the result as an offset into the IDT. The gate descriptor referenced by the IDT offset contains a segment-selector and a 64-bit segment-offset field. The gate-descriptor segment-offset field contains the complete virtual address for the interrupt handler. The gate-descriptor segment-selector field points to the target code-segment descriptor located in either the GDT or LDT. The code-segment descriptor is only used for privilege-checking purposes and for placing the processor in 64-bit mode. The code segment-descriptor base field, limit field, and most attributes are ignored.

Figure 8-12 shows how the long-mode interrupt handler is located by the interrupt mechanism.

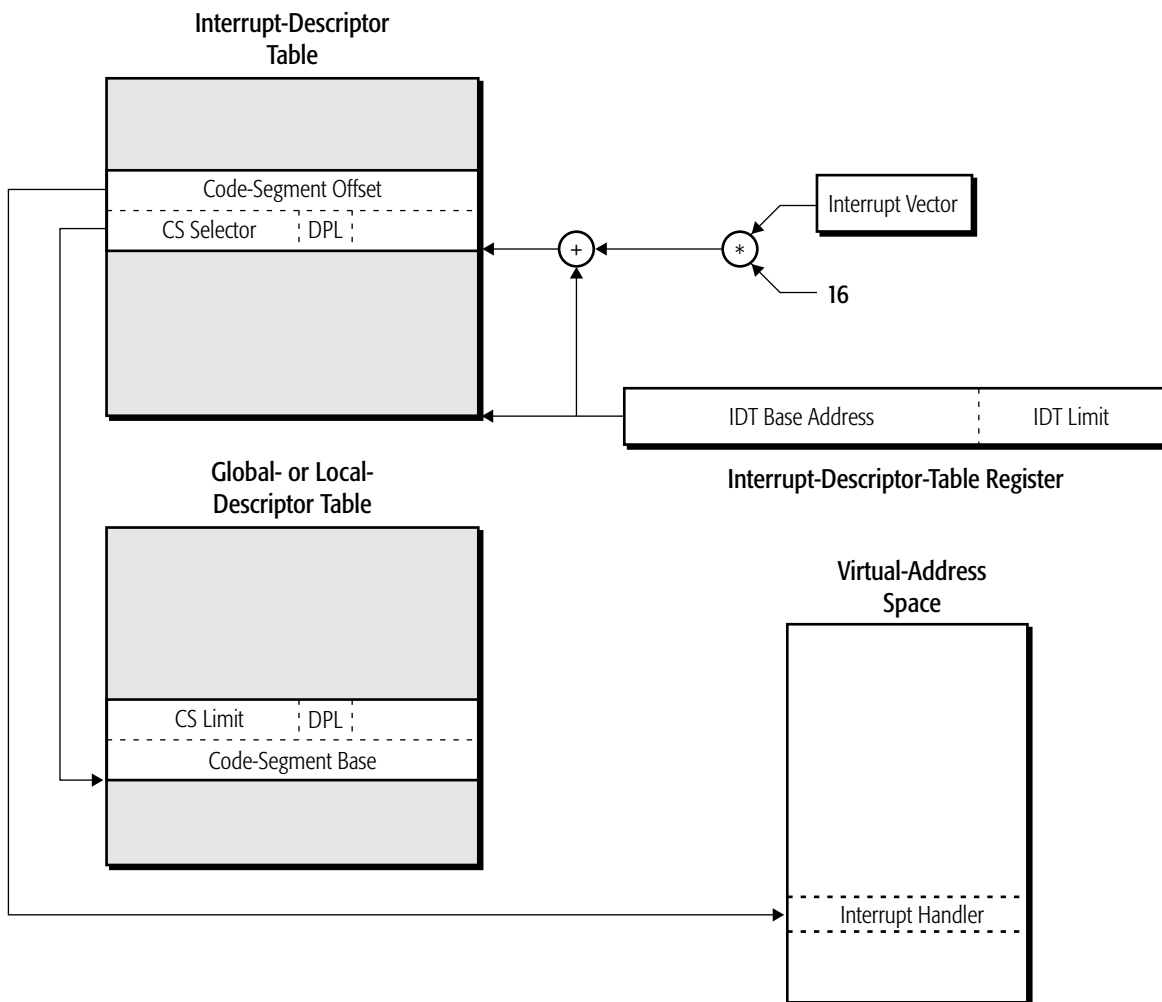

**Figure 8-12. Long-Mode Interrupt Control Transfer**



### 8.9.3 Interrupt Stack Frame

In long mode, the return-program stack pointer (SS:RSP) is always pushed onto the interrupt-handler stack, regardless of whether or not a privilege change occurs. Although the SS register is not used in 64-bit mode, SS is pushed to allow returns into compatibility mode. Pushing SS:RSP unconditionally presents operating systems with a consistent interrupt-stack-frame size for all interrupts, except for error codes. Interrupt service-routine entry points that handle interrupts generated by non-error-code interrupts can push an error code on the stack for consistency.

In long mode, when a control transfer to an interrupt handler occurs, the processor performs the following:

1. Aligns the new interrupt-stack frame by masking RSP with FFFF\_FFFF\_FFFF\_FFF0h.
2. If IST field in interrupt gate is not 0, reads IST pointer into RSP.
3. If a privilege change occurs, the target DPL is used as an index into the long-mode TSS to select a new stack pointer (RSP).
4. If a privilege change occurs, SS is cleared to zero indicating a null selector.
5. Pushes the return stack pointer (old SS:RSP) onto the new stack. The SS value is padded with six bytes to form a quadword.
6. Pushes the 64-bit RFLAGS register onto the stack. The upper 32 bits of the RFLAGS image on the stack are written as zeros.
7. Clears the TF, NT, and RF bits in RFLAGS bits to 0.
8. Handles the RFLAGS.IF bit according to the gate-descriptor type:
  - If the gate descriptor is an interrupt gate, RFLAGS.IF is cleared to 0.
  - If the gate descriptor is a trap gate, RFLAGS.IF is not modified.
9. Pushes the return CS register and RIP register onto the stack. The CS value is padded with six bytes to form a quadword.
10. If the interrupt vector number has an error code associated with it, pushes the error code onto the stack. The error code is padded with four bytes to form a quadword.
11. Loads the segment-selector field from the gate descriptor into the CS register. The processor checks that the target code-segment is a 64-bit mode code segment.
12. Loads the offset field from the gate descriptor into the target RIP. The interrupt handler begins execution when control is transferred to the instruction referenced by the new RIP.

Figure 8-13 on page 250 shows the stack after control is transferred to the interrupt handler.

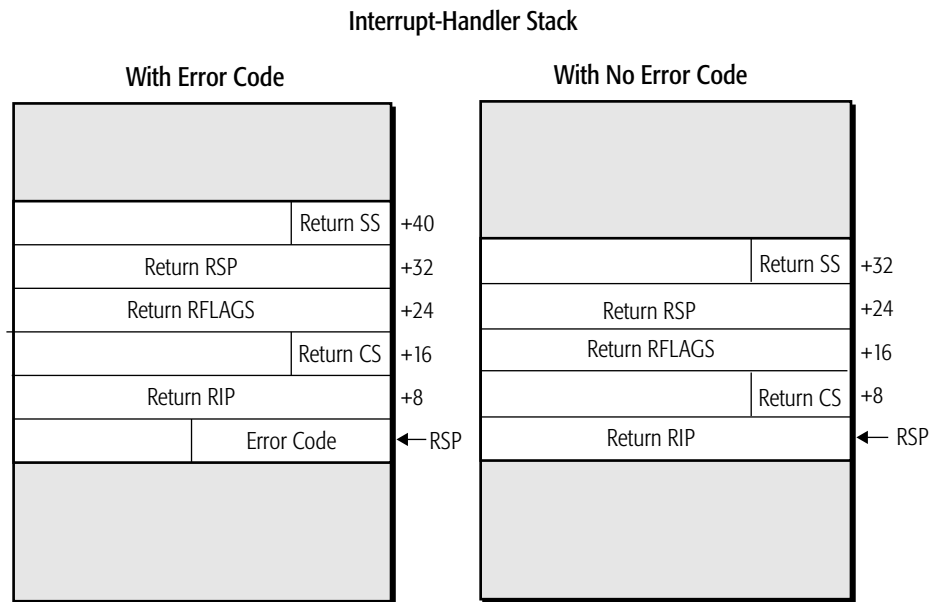

**Figure 8-13. Long-Mode Stack After Interrupt—Same Privilege**

**Interrupt-Stack Alignment.** In legacy mode, the interrupt-stack pointer can be aligned at any address boundary. Long mode, however, aligns the stack on a 16-byte boundary. This alignment is performed by the processor in hardware before pushing items onto the stack frame. The previous RSP is saved unconditionally on the new stack by the interrupt mechanism. A subsequent IRET instruction automatically restores the previous RSP.

Aligning the stack on a 16-byte boundary allows optimal performance for saving and restoring the 16-byte XMM registers. The interrupt handler can save and restore the XMM registers using the faster 16-byte aligned loads and stores (MOVAPS), rather than unaligned loads and stores (MOVUPS).

Although the RSP alignment is always performed in long mode, it is only of consequence when the interrupted program is already running at CPL=0, and it is generally used only within the operating-system kernel. The operating system should put 16-byte aligned RSP values in the TSS for interrupts that change privilege levels.

**Stack Switch.** In long mode, the stack-switch mechanism differs slightly from the legacy stack-switch mechanism (see “Interrupt To Higher Privilege” on page 240). When stacks are switched during a long-mode privilege-level change resulting from an interrupt, a new SS descriptor is *not* loaded from the TSS. Long mode only loads an inner-level RSP from the TSS. However, the SS selector is loaded with a null selector, allowing nested control transfers, including interrupts, to be handled properly in 64-bit mode. The SS.RPL is set to the new CPL value. See “Nested IRETs to 64-Bit Mode Procedures” on page 253 for additional information.

The interrupt-handler stack that results from a privilege change in long mode looks identical to a long-mode stack when no privilege change occurs. Figure 8-14 shows the stack after the switch is performed and control is transferred to the interrupt handler.

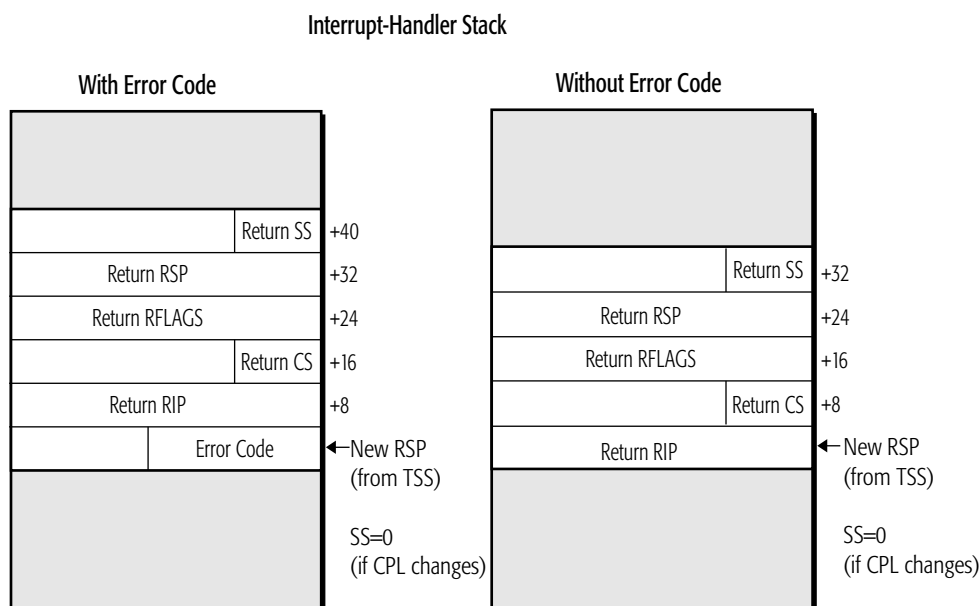

**Figure 8-14. Long-Mode Stack After Interrupt—Higher Privilege**

#### 8.9.4 Interrupt-Stack Table

In long mode, a new interrupt-stack table (IST) mechanism is introduced as an alternative to the modified legacy stack-switch mechanism described above. The IST mechanism provides a method for specific interrupts, such as NMI, double-fault, and machine-check, to always execute on a known-good stack. In legacy mode, interrupts can use the hardware task-switch mechanism to set up a known-good stack by accessing the interrupt service routine through a task gate located in the IDT. However, the hardware task-switch mechanism is not supported in long mode.

When enabled, the IST mechanism unconditionally switches stacks. It can be enabled on an individual interrupt vector basis using a new field in the IDT gate-descriptor entry. This allows some interrupts to use the modified legacy mechanism, and others to use the IST mechanism. The IST mechanism is only available in long mode.

The IST mechanism uses new fields in the 64-bit TSS format and the long-mode interrupt-gate and trap-gate descriptors:

- Figure 12-8 on page 339 shows the format of the 64-bit TSS and the location of the seven IST pointers. The 64-bit TSS offsets from 24h to 5Bh provide space for seven IST pointers, each of which are 64 bits (8 bytes) long.

- The long-mode interrupt-gate and trap-gate descriptors define a 3-bit IST-index field in bits 2:0 of byte +4. Figure 4-24 on page 93 shows the format of long-mode interrupt-gate and trap-gate descriptors and the location of the IST-index field.

To enable the IST mechanism for a specific interrupt, system software stores a non-zero value in the interrupt gate-descriptor IST-index field. If the IST index is zero, the modified legacy stack-switching mechanism (described in the previous section) is used.

Figure 8-15 shows how the IST mechanism is used to create the interrupt-handler stack. When an interrupt occurs and the IST index is non-zero, the processor uses the index to select the corresponding IST pointer from the TSS. The IST pointer is loaded into the RSP to establish a new stack for the interrupt handler. The SS register is loaded with a null selector if the CPL changes and the SS.RPL is set to the new CPL value. After the stack is loaded, the processor pushes the old stack pointer, RFLAGS, the return pointer, and the error code (if applicable) onto the stack. Control is then transferred to the interrupt handler.

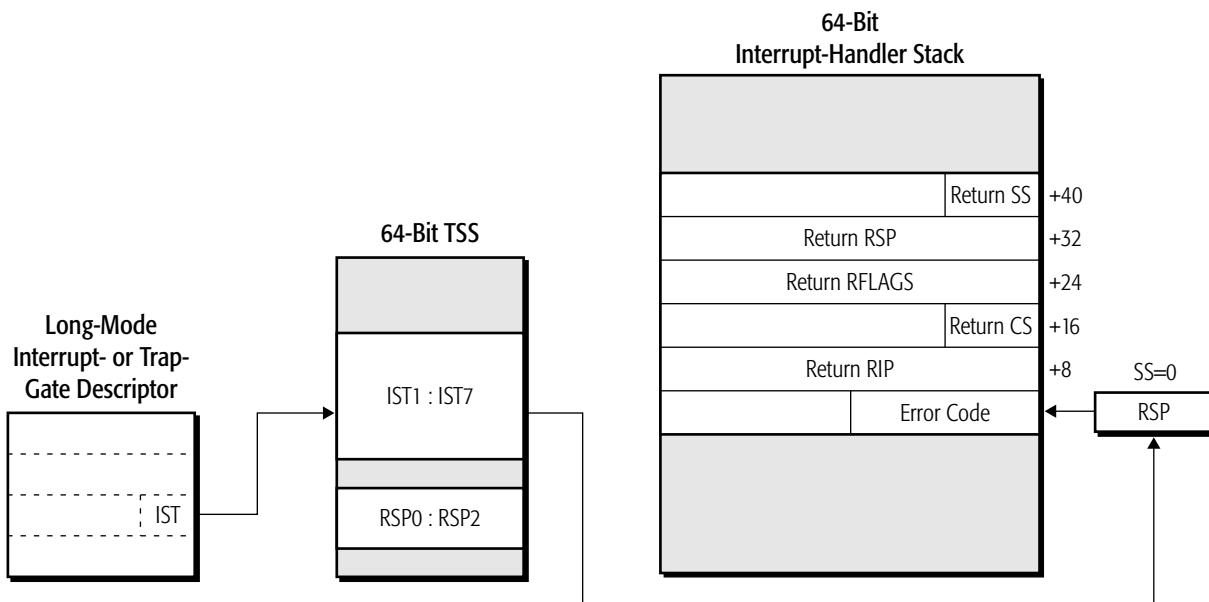

**Figure 8-15. Long-Mode IST Mechanism**

Software must make sure that an interrupt or exception handler using an IST pointer doesn't take another exception using the same IST pointer, this will result in the first stack exception frame being overwritten and lost.

### 8.9.5 Returning From Interrupt Procedures

As with legacy mode, a return to an interrupted program in long mode should be performed using the IRET instruction. However, in long mode, the IRET semantics are different from legacy mode:

- *In 64-bit mode*, IRET pops the return-stack pointer unconditionally off the interrupt-stack frame and into the SS:RSP registers. This reverses the action of the long-mode interrupt mechanism, which saves the stack pointer whether or not a privilege change occurs. IRET also allows a null selector to be popped off the stack and into the SS register. See “Nested IRETs to 64-Bit Mode Procedures” on page 253 for additional information.
- *In compatibility mode*, IRET behaves as it does in legacy mode. The SS:ESP is popped off the stack only if a control transfer to less privilege (numerically greater CPL) is performed. Otherwise, it is assumed that a stack pointer is not present on the interrupt-handler stack.

The long-mode interrupt mechanism always uses a 64-bit stack when saving values for the interrupt handler, and the interrupt handler is always entered in 64-bit mode. To work properly, an IRET used to exit the 64-bit mode interrupt-handler requires a series of eight-byte pops off the stack. This is accomplished by using a 64-bit operand-size prefix with the IRET instruction. The default stack size assumed by an IRET in 64-bit mode is 32 bits, so a 64-bit REX prefix is needed by 64-bit mode interrupt handlers.

**Nested IRETs to 64-Bit Mode Procedures.** In long mode, an interrupt causes a null selector to be loaded into the SS register if the CPL changes (this is the same action taken by a far CALL in long mode). If the interrupt handler performs a far call, or is itself interrupted, the null SS selector is pushed onto the stack frame, and another null selector is loaded into the SS register. Using a null selector in this way allows the processor to properly handle returns nested within 64-bit-mode procedures and interrupt handlers.

The null selector enables the processor to properly handle nested returns to 64-bit mode (which do not use the SS register), and returns to compatibility mode (which do use the SS register). Normally, an IRET that pops a null selector into the SS register causes a general-protection exception (#GP) to occur. However, in long mode, the null selector indicates the existence of nested interrupt handlers and/or privileged software in 64-bit mode. Long mode allows an IRET to pop a null selector into SS from the stack under the following conditions:

- The target mode is 64-bit mode.
- The target  $CPL < 3$ .

In this case, the processor does not load an SS descriptor, and the null selector is loaded into SS without causing a #GP exception.

## 8.10 Virtual Interrupts

The term *virtual interrupts* includes two classes of extensions to the interrupt-handling mechanism:

- *Virtual-8086 Mode Extensions (VME)*—These allow virtual interrupts and interrupt redirection in virtual-8086 mode. VME has no effect on protected-mode programs.
- *Protected-Mode Virtual Interrupts (PVI)*—These allow virtual interrupts in protected mode when CPL=3. Interrupt redirection is not available in protected mode. PVI has no effect on virtual-8086-mode programs.

Because virtual-8086 mode is not supported in long mode, VME extensions are not supported in long mode. PVI extensions are, however, supported in long mode.

### 8.10.1 Virtual-8086 Mode Extensions

The virtual-8086-mode extensions (VME) enable performance enhancements for 8086 programs running as protected tasks in virtual-8086 mode. These extensions are enabled by setting CR4.VME (bit 0) to 1. The extensions enabled by CR4.VME are:

- Virtualizing control and notification of maskable external interrupts with the EFLAGS VIF (bit 19) and VIP (bit 20) bits.
- Selective interception of software interrupts (INT $n$  instructions) using the TSS interrupt redirection bitmap (IRB).

**Background.** Legacy-8086 programs expect to have full access to the EFLAGS interrupt flag (IF) bit, allowing programs to enable and disable maskable external interrupts. When those programs run in virtual-8086 mode under a multitasking protected-mode environment, it can disrupt the operating system if programs enable or disable interrupts for their own purposes. This is particularly true if interrupts associated with one program can occur during execution of another program. For example, a program could request that an area of memory be copied to disk. System software could suspend the program before external hardware uses an interrupt to acknowledge that the block has been copied. System software could subsequently start a second program which enables interrupts. This second program could receive the external interrupt indicating that the memory block of the first program has been copied. If that were to happen, the second program would probably be unprepared to handle the interrupt properly.

Access to the IF bit must be managed by system software on a task-by-task basis to prevent corruption of system resources. In order to completely manage the IF bit, system software must be able to interrupt all instructions that can read or write the bit. These instructions include STI, CLI, PUSHF, POPF, INT $n$ , and IRET. These instructions are part of an instruction class that is *IOPL-sensitive*. The processor takes a general-protection exception (#GP) whenever an IOPL-sensitive instruction is executed and the EFLAGS.IOPL field is less than the CPL. Because all virtual-8086 programs run at CPL=3, system software can interrupt all instructions that modify the IF bit by setting IOPL<3.

System software maintains a virtual image of the IF bit for each virtual-8086 program by emulating the actions of IOPL-sensitive instructions that modify the IF bit. When an external maskable-interrupt occurs, system software checks the state of the IF image for the current virtual-8086 program to determine whether the program is masking interrupts. If the program is masking interrupts, system software saves the interrupt information until the virtual-8086 program attempts to re-enable

interrupts. When the virtual-8086 program unmask interrupts with an IOPL-sensitive instruction, system software traps the action with the #GP handler.

The performance of a processor can be significantly degraded by the overhead of trapping and emulating IOPL-sensitive instructions, and the overhead of maintaining images of the IF bit for each virtual-8086 program. This performance loss can be eliminated by running virtual-8086 programs with IOPL set to 3, thus allowing changes to the real IF flag from any privilege level. Unfortunately, this can leave critical system resources unprotected.

In addition to the performance problems caused by virtualizing the IF bit, software interrupts (INT $n$  instructions) cannot be masked by the IF bit or virtual copies of the IF bit. The IF bit only affects maskable external interrupts. Software interrupts in virtual-8086 mode are normally directed to the real mode interrupt vector table (IVT), but it can be desirable to redirect certain interrupts to the protected-mode interrupt-descriptor table (IDT).

The virtual-8086-mode extensions are designed to support both external interrupts and software interrupts, with mechanisms that preserve high performance without compromising protection. Virtualization of external interrupts is supported using two bits in the EFLAGS register: the virtual-interrupt flag (VIF) bit and the virtual-interrupt pending (VIP) bit. Redirection of software interrupts is supported using the interrupt-redirection bitmap (IRB) in the TSS. A separate TSS can be created for each virtual-8086 program, allowing system software to control interrupt redirection independently for each virtual-8086 program.

**VIF and VIP Extensions for External Interrupts.** When VME extensions are enabled, the IF-modifying instructions normally trapped by system software are allowed to execute. However, instead of modifying the IF bit, they modify the EFLAGS VIF bit. This leaves control over maskable interrupts to the system software. It can also be used as an indicator to system software that the virtual-8086 program is able to, or is expecting to, receive external interrupts.

When an unmasked external interrupt occurs, the processor transfers control from the virtual-8086 program to a protected-mode interrupt handler. If the interrupt handler determines that the interrupt is for the virtual-8086 program, it can check the state of the VIF bit in the EFLAGS value pushed on the stack for the virtual-8086 program. If the VIF bit is set (indicating the virtual-8086 program attempted to unmask interrupts), system software can allow the interrupt to be handled by the appropriate virtual-8086 interrupt handler.

If the VIF bit is clear (indicating the virtual-8086 program attempted to mask interrupts) and the interrupt is for the virtual-8086 program, system software can hold the interrupt pending. System software holds an interrupt pending by saving appropriate information about the interrupt, such as the interrupt vector, and setting the virtual-8086 program's VIP bit in the EFLAGS image on the stack. When the virtual-8086 program later attempts to set IF, the previously set VIP bit causes a general-protection exception (#GP) to occur. System software can then pass the saved interrupt information to the virtual-8086 interrupt handler.

To summarize, when the VME extensions are enabled (CR4.VME=1), the VIF and VIP bits are set and cleared as follows:

- **VIF Bit**—This bit is set and cleared by the processor in virtual-8086 mode in response to an attempt by a virtual-8086 program to set and clear the EFLAGS.IF bit. VIF is used by system software to determine whether a maskable external interrupt should be passed on to the virtual-8086 program, emulated by system software, or held pending. VIF is also cleared during software interrupts through interrupt gates, with the original VIF value preserved in the EFLAGS image on the stack.
- **VIP Bit**—System software sets and clears this bit in the EFLAGS image saved on the stack after an interrupt. It can be set when an interrupt occurs for a virtual-8086 program that has a clear VIF bit. The processor examines the VIP bit when an attempt is made by the virtual-8086 program to set the IF bit. If VIP is set when the program attempts to set IF, a general-protection exception (#GP) occurs *before* execution of the IF-setting instruction. System software must clear VIP to avoid repeated #GP exceptions when returning to the interrupted instruction.

The VIF and VIP bits can be used by system software to minimize the overhead associated with managing maskable external interrupts because virtual copies of the IF flag do not have to be maintained by system software. Instead, VIF and VIP are maintained during context switches along with the remaining EFLAGS bits.

Table 8-11 on page 258 shows how the behavior of instructions that modify the IF bit are affected by the VME extensions.

**Interrupt Redirection of Software Interrupts.** In virtual-8086 mode, software interrupts ( $INTn$  instructions) are trapped using a #GP exception handler if the IOPL is less than 3 (the CPL for virtual-8086 mode). This allows system software to interrupt and emulate 8086-interrupt handlers. System software can set the IOPL to 3, in which case the  $INTn$  instruction is vectored through a gate descriptor in the protected-mode IDT. System software can use the gate to control access to the virtual-8086 mode interrupt vector table (IVT), or to redirect the interrupt to a protected-mode interrupt handler.

When VME extensions are enabled, for  $INTn$  instructions to execute normally, vectoring directly to a virtual-8086 interrupt handler through the virtual-8086 IVT (located at address 0 in the virtual-address space of the task). For security or performance reasons, however, it can be necessary to intercept  $INTn$  instructions on a vector-specific basis to allow servicing by protected-mode interrupt handlers. This is performed by using the interrupt-redirection bitmap (IRB), located in the TSS and enabled when  $CR4.VME=1$ . The IRB is available only in virtual-8086 mode.

Figure 12-6 on page 334 shows the format of the TSS, with the interrupt redirection bitmap located near the top. The IRB contains 256 bits, one for each possible software-interrupt vector. The most-significant bit of the IRB controls interrupt vector 255, and is located immediately before the IOPB base. The least-significant bit of the IRB controls interrupt vector 0.

The bits in the IRB function as follows:

- When set to 1, the  $INTn$  instruction behaves as if the VME extensions are not enabled. The interrupt is directed through the IDT to a protected-mode interrupt handler if  $IOPL=3$ . If  $IOPL<3$ , the  $INTn$  causes a #GP exception.



- When cleared to 0, the  $INT_n$  instruction is directed through the IVT for the virtual-8086 program to the corresponding virtual-8086 interrupt handler.

Only software interrupts can be redirected using the IRB mechanism. External interrupts are asynchronous events that occur outside the context of a virtual-8086 program. Therefore, external interrupts require system-software intervention to determine the appropriate context for the interrupt. The VME extensions described in “VIF and VIP Extensions for External Interrupts” on page 255 are provided to assist system software with external-interrupt intervention.

### 8.10.2 Protected Mode Virtual Interrupts

The protected-mode virtual-interrupt (PVI) bit in CR4 enables support for interrupt virtualization in protected mode. When enabled, the processor maintains program-specific VIF and VIP bits similar to the manner defined by the virtual-8086 mode extensions (VME). However, unlike VME, only the STI and CLI instructions are affected by the PVI extension. When a program is running at  $CPL=3$ , it can use STI and CLI to set and clear its copy of the VIF flag without causing a general-protection exception. The last section of Table 8-11 on page 258 describes the behavior of instructions that modify the IF bit when PVI extensions are enabled.

The interrupt redirection bitmap (IRB) defined by the VME extensions is not supported by the PVI extensions.

### 8.10.3 Effect of Instructions that Modify EFLAGS.IF

Table 8-11 on page 258 shows how the behavior of instructions that modify the IF bit are affected by the VME and PVI extensions. The table columns specify the following:

- *Operating Mode*—the processor mode in effect when the instruction is executed.
- *Instruction*—the IF-modifying instruction.
- *IOPL*—the value of the EFLAGS.IOPL field.
- *VIP*—the value of the EFLAGS.VIP bit.
- *#GP*—indicates whether the conditions in the first four columns cause a general-protection exception (#GP) to occur.
- *Effect on IF Bit*—indicates the effect the conditions in the first four columns have on the EFLAGS.IF bit and the image of EFLAGS.IF on the stack.
- *Effect on VIF Bit*—indicates the effect the conditions in the first four columns have on the EFLAGS.VIF bit and the image of EFLAGS.VIF on the stack.

**Table 8-11. Effect of Instructions that Modify the IF Bit**

Operating Mode	Instruction	IOPL	VIP	#GP	Effect on IF Bit	Effect on VIF Bit
Real Mode <i>CR0.PE=0</i> <i>EFLAGS.VM=0</i> <i>CR4.VME=0</i> <i>CR4.PVI=0</i>	CLI			no	IF = 0	
	STI				IF = 1	
	PUSHF				EFLAGS.IF Stack Image = IF	
	POPF				IF = EFLAGS.IF stack image	
	INT <sub>n</sub>				EFLAGS.IF Stack Image = IF IF = 0	
	IRET				IF = EFLAGS.IF Stack Image	
Protected Mode <i>CR0.PE=1</i> <i>EFLAGS.VM=0</i> <i>CR4.VME=x</i> <i>CR4.PVI=0</i>	CLI	≥CPL		no	IF = 0	
		<CPL		yes	—	
	STI	≥CPL		no	IF = 1	
		<CPL		yes	—	
	PUSHF	x		no	EFLAGS.IF Stack Image = IF	
	POPF	≥CPL			IF = EFLAGS.IF Stack Image	
		<CPL			No Change	
	INT <sub>n</sub> gate	x			EFLAGS.IF Stack Image = IF IF = 0	
IRET	IF = EFLAGS.IF Stack Image					
IRETD						
Virtual-8086 Mode <i>CR0.PE=1</i> <i>EFLAGS.VM=1</i> <i>CR4.VME=0</i> <i>CR4.PVI=x</i>	CLI	3		no	IF = 0	
		< 3		yes	—	
	STI	3		no	IF = 1	
		< 3		yes	—	
	PUSHF	3		no	EFLAGS.IF Stack Image = IF	
		< 3		yes	—	
	POPF	3		no	IF = EFLAGS.IF Stack Image	
		< 3		yes	—	
	INT <sub>n</sub> gate	3		no	EFLAGS.IF Stack Image = IF IF = 0	
		< 3		yes	—	
	IRET	3		no	IF = EFLAGS.IF Stack Image	
		< 3		yes	—	
	IRETD	3		no	IF = EFLAGS.IF Stack Image	
		< 3		yes	—	

**Note:**

Gray-shaded boxes indicate the bits are unsupported (ignored) in the specified operating mode.  
 “x” indicates the value of the bit is a “don’t care”.  
 “—” indicates the instruction causes a general-protection exception (#GP).

**Note:**

1. If the EFLAGS.IF stack image is 0, no #GP exception occurs and the IRET instruction is executed.
2. If the EFLAGS.IF stack image is 1, the IRET is not executed, and a #GP exception occurs.

Table 8-11. Effect of Instructions that Modify the IF Bit (continued)

Operating Mode	Instruction	IOPL	VIP	#GP	Effect on IF Bit	Effect on VIF Bit
Virtual-8086 Mode with VME Extensions CR0.PE=1 EFLAGS.VM=1 CR4.VME=1 CR4.PVI=x	CLI	3	x	no	IF = 0	No Change
		<3			No Change	VIF = 0
	STI	3	x	no	IF = 1	No Change
		<3	0	no	No Change	VIF = 1
			1	yes	—	
	PUSHF	3	x	no	EFLAGS.IF Stack Image = IF	Not Pushed
		<3			Not Pushed	EFLAGS.IF Stack Image = VIF
	PUSHFD	3	x	no	EFLAGS.IF Stack Image = IF	EFLAGS.VIF Stack Image = VIF
		<3		yes	—	
	POPF	3	x	no	IF = EFLAGS.IF Stack Image	No Change
		<3	0	no	No Change	VIF = EFLAGS.IF Stack Image
			1	yes	—	
	POPFD	3	x	no	IF = EFLAGS.IF Stack Image	No Change
		<3		yes	—	
	INTn gate	3	x	no	EFLAGS.IF Stack Image = IF IF = 0	No Change
		<3			No Change	EFLAGS.IF Stack Image = VIF VIF = 0
	IRET	3	x	no	IF = EFLAGS.IF Stack Image	No Change
		<3	0	no	No Change	VIF = EFLAGS.IF Stack Image
			1	no <sup>1</sup>	No Change	VIF = EFLAGS.IF Stack Image
				yes <sup>2</sup>	—	
IRETD	3	x	no	IF = EFLAGS.IF Stack Image	VIF = EFLAGS.IF Stack Image	
	<3		yes	—		

**Note:**

Gray-shaded boxes indicate the bits are unsupported (ignored) in the specified operating mode.

“x” indicates the value of the bit is a “don’t care”.

“—” indicates the instruction causes a general-protection exception (#GP).

**Note:**

1. If the EFLAGS.IF stack image is 0, no #GP exception occurs and the IRET instruction is executed.

2. If the EFLAGS.IF stack image is 1, the IRET is not executed, and a #GP exception occurs.

**Table 8-11. Effect of Instructions that Modify the IF Bit (continued)**

Operating Mode	Instruction	IOPL	VIP	#GP	Effect on IF Bit	Effect on VIF Bit
Protected Mode with PVI Extensions <i>CR0.PE=1</i> <i>EFLAGS.VM=0</i> <i>CR4.VME=x</i> <i>CR4.PVI=1</i> <i>CPL=3</i>	CLI	3	x	no	IF = 0	No Change
		<3			No Change	VIF = 0
	STI	3	x	no	IF = 1	No Change
		<3	0	no	No Change	VIF = 1
			1	yes	—	
	PUSHF	x	x	no	EFLAGS.IF Stack Image = IF	Not Pushed
	PUSHFD				EFLAGS.VIF Stack Image = VIF	
	POPF				IF = EFLAGS.IF Stack Image	No Change
	POPFD				VIF = 0	
	INTn gate				EFLAGS.IF Stack Image = IF IF = 0 (if interrupt gate)	No Change
IRET	IF = EFLAGS.IF Stack Image				No Change	
IRETD	VIF = EFLAGS.VIF Stack Image					

**Note:**

Gray-shaded boxes indicate the bits are unsupported (ignored) in the specified operating mode.

“x” indicates the value of the bit is a “don’t care”.

“—” indicates the instruction causes a general-protection exception (#GP).

**Note:**

1. If the EFLAGS.IF stack image is 0, no #GP exception occurs and the IRET instruction is executed.
2. If the EFLAGS.IF stack image is 1, the IRET is not executed, and a #GP exception occurs.

## 9 Machine Check Architecture

---

The AMD64 Machine Check Architecture (MCA) plays a vital role in the reliability, availability, and serviceability (RAS) of AMD processors, as well as the RAS of the computer systems in which they are embedded. MCA defines the facilities by which processor and system hardware errors are logged and reported to system software. This allows system software to serve a strategic role in recovery from and diagnosis of hardware errors.

Error checking hardware is configured and information about detected error conditions is conveyed via an architecturally-defined set of registers. The system programming interface of MCA is described below in Section 9.3 “Machine Check Architecture MSRs” on page 265.

### 9.1 Introduction

All computer systems are susceptible to errors—results that are contrary to the system design. Errors can be categorized as *soft* or *hard*. Soft errors are caused by transient interference and are not necessarily indicative of any damage to the computer circuitry. These external events include noise from electromagnetic radiation and the incursion of sub-atomic particles that cause bit cell storage capacitors to change state.

Hard errors are repeatable malfunctions that are generally attributable to physical damage to computer circuitry. Damage may be caused by external forces (for example, voltage surges) or wear processes inherent in the circuit technology. Damaged circuit elements can manifest symptoms similar to those that are caused by soft error processes. An increase in the frequency of errors attributable to one circuit element may indicate that the element has sustained damage or is wearing-out and may, in the future, cause a hard error.

#### 9.1.1 Reliability, Availability, and Serviceability

This section describes the concepts of reliability, availability, and serviceability (RAS) and shows how they are interrelated.

The rate at which errors occur in a computer system is a measure of the system’s *reliability*. *Availability* is the percentage of time that the system is available to do useful work. Errors that prevent a computer system from continued operation result in *down-time*, that is, periods of unavailability. Down-time includes the amount of time required to restore the system to operation. This may include the time to diagnose a failure, determine the field replaceable unit (FRU) containing the faulty circuitry, carry out the repair action required to replace the identified FRU, and restart the system. This time directly impacts the system’s availability and is a measure of the system’s *serviceability*.

The availability of a computer system can be increased without decreasing performance or significantly increasing cost through the judicious addition of data and control path redundancy in concert with dedicated error-checking hardware. Together, redundancy and error checking *detect* and

often *correct* hardware errors. When errors are corrected by hardware, system operation continues without any perceptible disruption or loss in performance.

Another important technique that can prevent down-time is *error containment*. Error containment limits the propagation of an erroneous data. This enhances system availability by limiting the effects of errors to a subset of software or hardware resources. System software may either correct the error and resume the interrupted program or, if the error cannot be corrected, terminate software processes that cannot continue due to the error.

Error logging enhances serviceability by providing information that is used to identify the FRU that contains the failed circuitry. The mechanical design of the computer system can enhance serviceability (and thus availability) by making the task of physically replacing a failed FRU quicker and easier.

### 9.1.2 Error Detection, Logging, and Reporting

Error detection requires specific error-checking hardware that compares the actual result of some data transfer or transformation to the expected result. Any disparity indicates that an error has occurred. Error detection is controlled through implementation-specific means. Disabling detection is normally only appropriate when hardware is being debugged in the laboratory.

When an error is detected, hardware autonomously acts to either correct the error or contain the propagation of the corrupting effects of an uncorrected error. For some error sources, hardware action can be disabled by software through the MCA interface.

As hardware acts to correct or contain a detected error, it gathers information about the error to aid in recovery, diagnosis, and repair. The architecture provides software control of error *logging* and *reporting*. The following describes the characteristics of each:

- **Logging**  
Logging involves saving information about the error in specific MCA registers. If the error reporting bank associated with the error source is enabled, logging occurs; if disabled, error information is generally discarded (there are implementation-specific exceptions).
- **Reporting**  
An uncorrected error may be reported to system software via a machine-check exception, if error reporting for the specific error source is enabled.

Reporting is the hardware-initiated action of interrupting the processor using a machine-check exception (#MC). Reporting for each specific error type can be enabled or disabled by system software through the MCA register interface. Even if reporting for an error type is disabled, logging may continue.

Disabling reporting can negatively impact both error containment and error recovery (see the next section) and should be avoided.

Hardware categorizes errors into three classes. These are:

- *corrected*

- *uncorrected*
- *deferred*

The following sections describe the characteristics of each of these error classes:

If an error can be corrected by hardware, no immediate action by software is required. In this case, information is logged, if enabled, to aid in later diagnosis and possible repair.

If correction is not possible, the error is classified as uncorrected. The occurrence of an uncorrected error requires immediate action by system software to either correct the error and resume the interrupted program or, if software-based correction is not possible, to determine the extent of the impact of the uncorrected error to any executing instruction stream or the architectural state of the processor or system and take actions to contain the error condition by terminating corrupted software processes.

For errors that are not corrected, but have no immediate impact on the architectural state of the system, processor core, or any current thread of execution, the error may be classified by hardware as a deferred error. Information about deferred errors is logged, if enabled, but not reported via a machine-check exception. Instead hardware monitors the error and escalates the error classification to uncorrected at the point in time where the error condition is about to impact the execution of an instruction stream or cause the corruption of the processor core or system architectural state.

This escalation results in a #MC exception, assuming that reporting for that error source is enabled. If software can correct the error, it may be possible to resume the affected program. If not, software can terminate the affected program rather than bringing down the entire system. This is referred to as *error localization*.

A common example of deferred error processing and localization is the conversion of globally uncorrected DRAM errors to process-specific consumed memory errors. In this example, uncorrected ECC-protected data that has not yet been consumed by any processor core is tagged as “poison.” Hardware reports the uncorrected data as a localized error via a #MC exception when it is about to be used (“consumed”) by an instruction execution stream.

In contrast, an error that cannot be contained and is of such severity that it has compromised the continued operation of a processor core requires immediate action to terminate system processing and may result in a hardware-enforced *shutdown*. In the shutdown state, the execution of instructions by that processor core is halted. See Section 8.2.9 “#DF—Double-Fault Exception (Vector 8)” on page 220 for a description of the shutdown processor state.

If supported, system software can choose to configure and enable hardware to generate an interrupt when a deferred error is first detected. Corrected errors may be counted as they are logged. If supported and enabled, exceeding a software-configured count threshold may be signalled via an interrupt. These notification mechanisms are independent of machine-check reporting.

Specific details on hardware error detection, logging, and reporting are implementation-dependent and are described in the *BIOS and Kernel Developer’s Guide* applicable to your product.

### 9.1.3 Error Recovery

When errors cannot be corrected by hardware, *error recovery* comes into play. Error recovery, as defined by MCA, always involves software intervention. Logged information about the uncorrected error condition that caused the exception allows system software to take actions to either correct the error and resume the interrupted execution stream or terminate software processes (or higher-level software constructs) that are known to be affected by the uncorrected error.

From a system perspective, all errors are either recoverable or unrecoverable. The following outlines the characteristics of each:

- *Recoverable*—Hardware has determined that the architectural state of the processor experiencing the uncorrected error has not been compromised. Software execution can continue if system software can determine the extent of the error and take actions to either:
  - *correct* the error and *resume* the interrupted stream of execution or,
  - if this is not possible, *terminate* software processes that have incurred a loss of architectural state and *continue* other software processes that are unaffected by the error.
- *Unrecoverable*—Hardware has determined that the architectural state of the processor experiencing the uncorrected error has been corrupted. Software execution cannot reliably continue.

Software saves any diagnostic information that it may be able to gather and halts.

The fact that an error is recoverable does not mean that recovery software will be able to resume program execution. If it is unable to determine the extent of the corruption or if it determines that essential state information has been lost, it may only be able to save information about the error and halt processing.

System software has many options to recover from an uncorrected error. The following is a partial list of possible actions that system software might take:

- If it can be determined that the corruption caused by the uncorrected error is contained within a software process, software can kill the process.
- If the uncorrected error has corrupted the architectural state of a virtual machine, the VMM can rebuild the container (using only hardware resources that are known to be good) and reboot the guest operating system.
- If the uncorrected error is a part of a block of data being transferred to or from an I/O device, the data transfer can be flushed and retried or terminated with an error.
- If the uncorrected error is due to a hard link failure, software can reconfigure the network to route information around the failed link.
- If the uncorrected error is in a cache and the cache line containing the uncorrected (known bad) data is in the shared state, software can invalidate the line so that it will be reloaded from memory or another cache that has the line in the owned state.



Many more error scenarios are recoverable depending on the effectiveness of hardware error containment, the logging capabilities of the system, and the sophistication of the recovery software that acts on the information conveyed through the MCA reporting structure.

If recovery software is unable to restore a valid system architectural state at some level of software abstraction (process, guest operating system, virtual machine, or virtual machine monitor), the uncorrected error is considered *system fatal*. In this situation, system software must halt the execution of instructions. A system reset is required to restore the system to a known-good architectural state.

## 9.2 Determining Machine-Check Architecture Support

Support for the machine-check architecture is implementation-dependent. System software executes the CPUID instruction to determine whether a processor implements the machine-check exception (#MC) and the global MCA MSR. The CPUID Fn0000\_0001\_EDX[MCE] feature bit indicates support for the machine-check exception and the CPUID Fn0000\_0001\_EDX[MCA] feature bit indicates support for the base set of global machine-check MSRs.

Once system software determines that the base set of MCA MSRs is available, it determines the implemented number of machine-check reporting banks by reading the machine-check capabilities register (MCG\_CAP), which is the first of the global MCA MSRs.

For a processor implementation to provide an architecturally compliant MCA interface, it must provide support for the machine-check exception, the global machine-check MSRs, the watchdog timer (see “CPU Watchdog Timer Register” on page 268.), and at least one bank of the machine-check reporting registers.

Support for the deferred reporting and software-based containment of uncorrected data errors is indicated by the feature bit CPUID Fn8000\_0007\_EBX[SUCCOR].

Support for recoverable MCA overflow conditions is indicated by feature bit CPUID Fn8000\_0007\_EBX[McaOverflowRecov]. See the discussion of recoverable status overflow in Section “MCA Overflow” on page 270.

Implementation-specific information concerning the machine-check mechanism can be found in the *BIOS and Kernel Developer’s Guide* applicable to your product. For more information on using the CPUID instruction, see Section 3.3, “Processor Feature Identification,” on page 63.

## 9.3 Machine Check Architecture MSRs

The AMD64 Machine-Check Architecture defines the set of model-specific registers (MCA MSRs) used to log and report hardware errors. These registers are:

- Global status and control registers:
  - Machine-check global-capabilities register (MCG\_CAP)
  - Machine-check global-status register (MCG\_STATUS)

- Machine-check global-control register (MCG\_CTL)
- One or more error-reporting register banks, each containing:
  - Machine-check control register (MCi\_CTL)
  - Machine-check status register (MCi\_STATUS)
  - Machine-check address register (MCi\_ADDR)
  - At least one machine-check miscellaneous error-information register (MCi\_MISC0)

Each error-reporting register bank is associated with a specific processor unit (or group of processor units).

- CPU Watchdog Timer register (CPU\_WATCHDOG\_TIMER)

The error-reporting registers retain their values through a warm reset. (A warm reset occurs while power to the processor is stable. This in contrast to a cold reset, which occurs during the application of power after a period of power loss.) This preservation of error information allows the platform firmware or other system-boot software to recover and report information associated with the error when the processor is forced into a shutdown state.

The RDMSR and WRMSR instructions are used to read and write the machine-check MSR. See “Machine-Check MSRs” on page 574 for a listing of the machine-check MSR numbers and their reset values. The following sections describe each MCA MSR and its function.

### 9.3.1 Global Status and Control Registers

The global status and control MSRs are the MCG\_CAP, MCG\_STATUS, and MCG\_CTL registers.

**Machine-Check Global-Capabilities Register.** Figure 9-1 shows the format of the machine-check global-capabilities register (MCG\_CAP). MCG\_CAP is a read-only register that specifies the machine-check mechanism capabilities supported by the processor implementation.

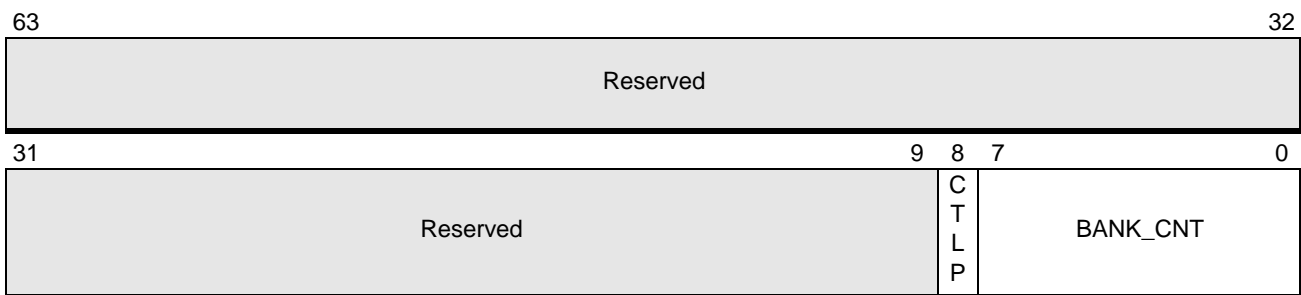

Bits	Mnemonic	Description	R/W
63:9	Reserved		
8	CTLP	MCG_CTL register present	R
7:0	BANK_CNT	Number of reporting banks	R

**Figure 9-1. MCG\_CAP Register**

The fields within the MCG\_CAP register are:

- *BANK\_CNT* (*MCi Bank Count*)—Bits 7:0. This field specifies how many error-reporting register banks are supported by the processor implementation.
- *CTLP* (*MCG\_CTL Register Present*)—Bit 8. This bit specifies whether or not the Machine-Check Global-Control (MCG\_CTL) Register is supported by the processor. When the bit is set to 1, the register is supported. When the bit is cleared to 0, the register is unsupported. The MCG\_CTL register is described on page 268.

All remaining bits in the MCG\_CAP register are reserved. Writing values to the MCG\_CAP register produces undefined results.

**Machine-Check Global-Status Register.** Figure 9-2 shows the format of the machine-check global-status register (MCG\_STATUS). MCG\_STATUS provides basic information about the processor state after the occurrence of a machine-check error.

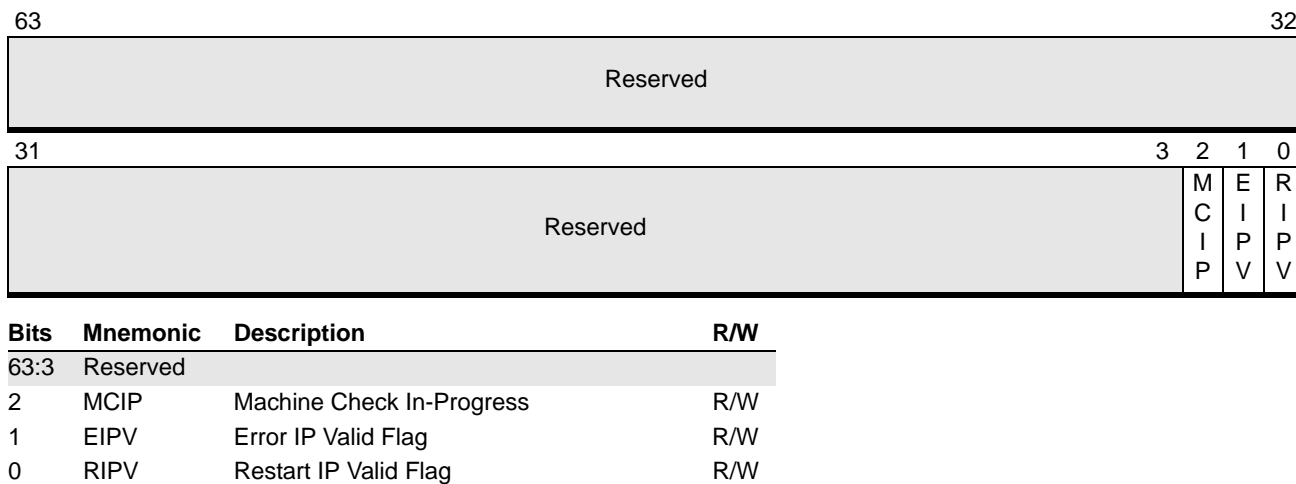

**Figure 9-2. MCG\_STATUS Register**

The fields within the MCG\_STATUS register are:

- *Restart-IP Valid (RIPV)*—Bit 0. When this bit is set to 1, the interrupted program can be reliably restarted at the instruction addressed by the instruction pointer pushed onto the stack by the machine-check error mechanism. If this bit is cleared to 0, the interrupted program cannot be reliably restarted.
- *Error-IP Valid (EIPV)*—Bit 1. When this bit is set to 1, the instruction that is referenced by the instruction pointer pushed onto the stack by the machine-check error mechanism is responsible for the machine-check error. If this bit is cleared to 0, it is possible that the instruction referenced by the instruction pointer is not responsible for the machine-check error.
- *Machine Check In-Progress (MCIP)*—Bit 2. When this bit is set to 1, it indicates that a machine-check error is in progress. If another machine-check error occurs while this bit is set, the processor

enters the shutdown state. The processor sets this bit whenever a machine check exception is generated. Software is responsible for clearing it after the machine check exception is handled.

All remaining bits in the MCG\_STATUS register are reserved.

**Machine-Check Global-Control Register.** Figure 9-3 shows the format of the machine-check global-control register (MCG\_CTL). MCG\_CTL is used by software to enable or disable the logging and reporting of machine-check errors from the implemented error-reporting banks. Depending on the implementation, detected errors from some error sources associated with a reporting bank that is disabled are still logged. Setting all bits to 1 in this register enables all implemented error-reporting register banks to log errors.

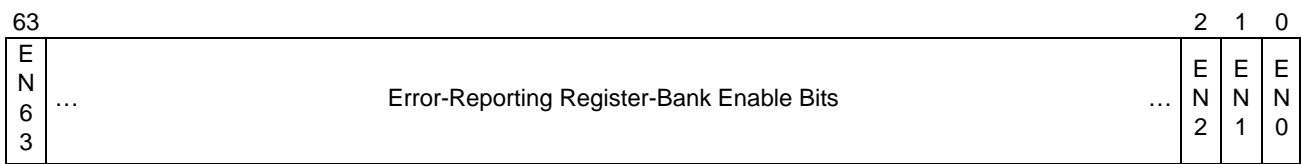
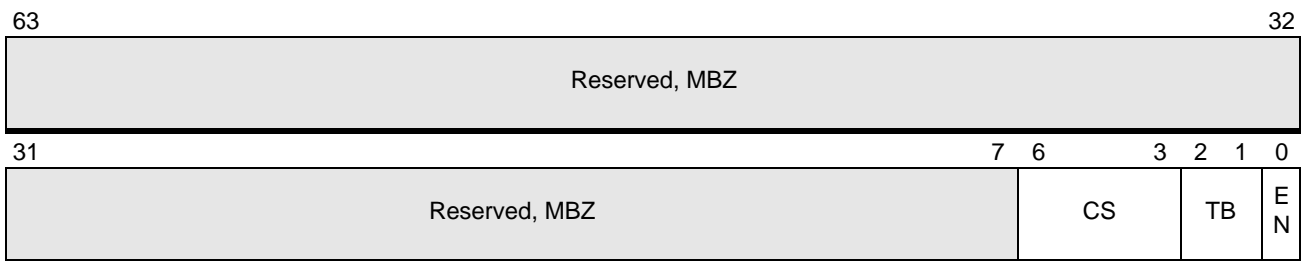

Figure 9-3. MCG\_CTL Register

**CPU Watchdog Timer Register.** The CPU watchdog timer is used to generate a machine check condition when an instruction does not complete within a time period specified by the CPU Watchdog Timer register. The timer restarts the count each time an instruction completes, when enabled by the *CPU Watchdog Timer Enable* bit. The time period is determined by the *Count Select* and *Time Base* fields. The timer does not count during halt or stop-grant.

The format of the CPU watchdog timer is shown in Figure 9-4.



Bits	Mnemonic	Description	R/W
63:7	Reserved	Reserved, Must be Zero	
6:3	CS	CPU Watchdog Timer Count Select	R/W
2:1	TB	CPU Watchdog Timer Time Base	R/W
0	EN	CPU Watchdog Timer Enable	R/W

Figure 9-4. CPU Watchdog Timer Register Format

*CPU Watchdog Timer Enable (EN)* - Bit 0. This bit specifies whether the CPU Watchdog Timer is enabled. When the bit is set to 1, the timer increments and generates a machine check when the timer expires. When cleared to 0, the timer does not increment and no machine check is generated.

*CPU Watchdog Timer Time Base (TB)* - Bits 2:1. Specifies the time base for the time-out period indicated in the *Count Select* field. The allowable time base values are provided in Table 9-1.

**Table 9-1. CPU Watchdog Timer Time Base**

TB[1:0]	Time Base
00b	1 millisecond
01b	1 microsecond
10b	5 nanoseconds
11b	Reserved

*CPU Watchdog Timer Count Select (CS)* - Bits 6:3. Specifies the time period required for the CPU Watchdog Timer to expire. The time period is this value times the time base specified in the *Time Base* field. The allowable values are shown in Table 9-2.

**Table 9-2. CPU Watchdog Timer Count Select**

CS[3:0]	Value
0000b	4095
0001b	2047
0010b	1023
0011b	511
0100b	255
0101b	127
0110b	63
0111b	31
1000b	8191
1001b	16383
1010b– 1111b	Reserved

### 9.3.2 Error-Reporting Register Banks

Each error-reporting register bank contains the following registers:

- Machine-check control register (*MCi\_CTL*).
- Machine-check status register (*MCi\_STATUS*).
- Machine-check address register (*MCi\_ADDR*).
- Machine-check miscellaneous error-information register 0 (*MCi\_MISC0*).

The *i* in each register name corresponds to the number of a supported register bank. Each error-reporting register bank is normally associated with a specific execution unit. The number of error-reporting register banks is implementation-specific. For more information, see the *BIOS and Kernel Developer's Guide* applicable to your product.

Software reads the MCG\_CAP register to determine the number of supported register banks. The first error-reporting register (MC0\_CTL) always starts with MSR address 400h, followed by MC0\_STATUS (401h), MC0\_ADDR (402h), and MC0\_MISC0 (403h). The addresses of any additional error-reporting MSRs are assigned sequentially starting at 404h through the remaining supported register banks.

**MCA Overflow.** If an error occurs within an error reporting bank while the status register for that bank contains valid data ( $MCi\_STATUS[VAL] = 1$ ), an MCA overflow condition results. In this situation, information about the new error will either be discarded or will replace the information about the prior error.

Hardware sets the  $MCi\_STATUS[OVER]$  bit to indicate this condition has occurred and follows a set of rules to determine whether to overwrite the previously logged error information or discard the new error information. These rules are shown in Table 9-3 below.

**Table 9-3. Error Logging Priorities**

		Previous Error Type		
		Corrected	Deferred	Uncorrected
Current Error Type	Corrected	Discard Current	Discard Current	Discard Current
	Deferred	Overwrite Previous	Discard Current	Discard Current
	Uncorrected	Overwrite Previous	Overwrite Previous	Discard Current
<b>Note(s):</b>				
1. Logging a deferred error has priority over the retention of information concerning a prior corrected error.				
2. Logging an uncorrected error has priority over the retention of information concerning either a prior deferred or corrected error.				
3. Valid Information concerning an uncorrected error is not overwritten by any subsequent errors.				

If the VAL bit is not set, hardware writes the appropriate logging registers based on the type of error (writing the  $MCi\_STATUS$  register last) and then sets the VAL bit to indicate to software that the information currently contained in the  $MCi\_STATUS$  register is valid. Software clears the VAL bit after reading the contents of this register (after reading and saving valid information stored in any of the other logging registers) to indicate to hardware that it has saved the information, making the registers available to log the next error.

If survivable MCA overflow is supported by the implementation (as indicated by CPUID Fn8000\_0007\_EBX[McaOverflowRecov] = 1), the state of the  $MCi\_STATUS[PCC]$  bit indicates whether system execution can continue. If a particular processor does not support survivable MCA overflow and overflow occurs, software must halt instruction execution on that processor core regardless of the state of the PCC bit because critical information may have been lost as a result of the



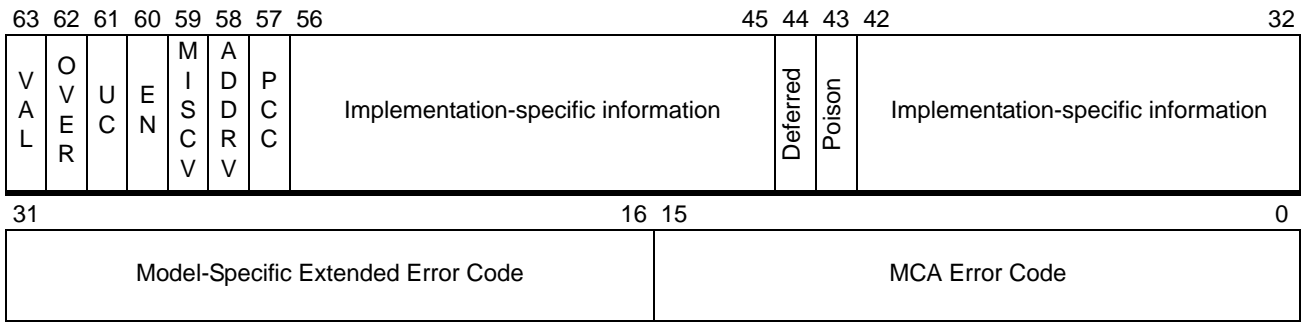

Bits	Mnemonic	Description	R/W
63	VAL	Valid	R/W*
62	OVER	Status Register Overflow	R/W*
61	UC	Uncorrected Error	R/W*
60	EN	Error Condition Enabled	R/W*
59	MISCV	Miscellaneous-Error Register Valid	R/W*
58	ADDRV	Error-Address Register Valid	R/W*
57	PCC	Processor-Context Corrupt	R/W*
56:45		Implementation-specific information	R/W*
44	Deferred	Deferred error	R/W*
43	Poison	Poisoned data consumed	R/W*
42:32		Implementation-specific information	R/W*
31:16		Model-Specific Extended Error Code	R/W*
15:0		MCA Error Code	R/W*

\*System software can only clear this bit to 0.

**Figure 9-6. MCI\_STATUS Register**

The fields within the MCI\_STATUS register are:

- *MCA Error Code*—Bits 15:0. This field encodes information about the error, including:
  - The type of transaction that caused the error.
  - The memory-hierarchy level involved in the error.
  - The type of request that caused the error.
  - Other information concerning the transaction type.

See the *BIOS and Kernel Developer's Guide* applicable to your product for information on the format and encoding of the MCA error code.

- *Model-Specific Extended Error Code*—Bits 31:16. This field encodes model-specific information about the error. For further information, see the documentation for particular implementations of the architecture.
- *Implementation-specific Information*—Bits 56:45, 42:32. These bit ranges hold model-specific error information. Software should not rely on the field definitions in these ranges being consistent between processor implementations.



- *Poison*—Bit 43. When set to 1, this bit indicates that the uncorrected error condition being reported is due to the attempted use of data that was previously detected as in error (and could not be corrected) and marked as known-bad.
- *Deferred*—Bit 44. When set to 1, this bit indicates that hardware has determined that the error condition being logged has not affected the execution of any instruction stream and that action by system software to prevent or correct an error is not required. No machine-check exception is signalled. Hardware will monitor the error and log an uncorrected error when the execution of any thread of execution is impacted.
- *PCC*—Bit 57. When set to 1, this bit indicates that the processor state is likely to be corrupt due to an uncorrected error. In this case, it is possible that software cannot reliably continue execution. When this bit is cleared, the processor state is not corrupted and recovery is still possible. If the PCC bit is set in any error bank, the processor will clear RIPV and EIPV in the MCG\_STATUS register.
- *ADDRV*—Bit 58. When set to 1, this bit indicates that the contents of the corresponding error-reporting address register (MCi\_ADDR) are valid. When this bit is cleared, the contents of MCi\_ADDR are not valid.
- *MISCV*—Bit 59. When set to 1, this bit indicates that additional information about the error is saved in the corresponding error-reporting miscellaneous register (MCi\_MISC0). When cleared, this bit indicates that the contents of the MCi\_MISC0 register are not valid.
- *EN*—Bit 60. When set to 1, this bit indicates that the error condition is enabled in the corresponding error-reporting control register (MCi\_CTL). Errors disabled by MCi\_CTL do not cause a machine-check exception.
- *UC*—Bit 61. When set to 1, this bit indicates that the logged error status is for an uncorrected error. When cleared, the error class is determined by looking at the Deferred bit; the error is a Corrected error if the Deferred bit is clear or a Deferred error if the Deferred bit is set. (See Section 9.1.2, “Error Detection, Logging, and Reporting,” on page 262, for more detail on these error classes.)
- *OVER*—Bit 62. This bit is set to 1 by the processor if the VAL bit is already set to 1 as the processor attempts to write error information into MCi\_STATUS. In this situation, the machine-check mechanism handles the contents of MCi\_STATUS as follows:
  - For processor implementations that log errors for disabled reporting banks, status for an enabled error replaces status for a disabled error.
  - Status for a deferred error replaces status for a corrected error.
  - Status for an uncorrected error replaces status for a corrected or deferred error.
  - Status for an enabled uncorrected error is never replaced.See Section “MCA Overflow” on page 270 for more information on this field.
- *VAL*—Bit 63. This bit is set to 1 by the processor if the contents of MCi\_STATUS are valid. Software should clear the VAL bit after reading the MCi\_STATUS register, otherwise a subsequent machine-check error sets the OVER bit as described above.

When a machine-check error occurs, the processor writes an error code into the appropriate `MCi_STATUS` register MCA error-code field. The `MCi_STATUS[VAL]` bit is set to 1, indicating that the `MCi_STATUS` register contents are valid.

MCA error-codes are used to report errors in the memory hierarchy, the system bus, and the system-interconnection logic. Error-codes are divided into subfields that are used to describe the cause of an error. The information is implementation-specific. For further information, see the *BIOS and Kernel Developer's Guide* applicable to your product.

**Machine-Check Address Registers.** Each error-reporting register bank includes a machine-check address register (`MCi_ADDR`) that the processor uses to report the address or location associated with the logged error. The address field can hold a virtual (linear) address, a physical address, or a value indicating an internal physical location, depending on the type of error. For further information, see the documentation for particular implementations of the architecture. The contents of this register are valid only if the `ADDRV` bit in the corresponding `MCi_STATUS` register is set to 1.

**Machine-Check Miscellaneous-Error Information Register 0 (`MCi_MISC0`).** Each error-reporting register bank includes the Machine-Check Miscellaneous 0 register that the processor uses to report additional error information.

In some implementations, the `MCi_MISC0` register is used for error thresholding. Thresholding is a mechanism provided by hardware to:

- count detected errors, and
- (optionally) generate an APIC-based interrupt when a programmed number of errors has been counted.

Processor hardware counts detected errors and ensures that multiple error sources do not share the same thresholding register. Software can use corrected error counts to help predict which components might soon fail (begin generating uncorrectable errors) and schedule their replacement.

Threshold counters increment for error sources that are enabled for logging.

The `MCi_MISC0[BlkPtr]` field is used to point to any additional `MCi_MISCj` registers, where  $j > 0$ . If this field is zero, no additional `MCi_MISC` registers are implemented.

**Additional Machine-Check Miscellaneous-Error Information Registers (`MCi_MISCj`).** If the `MCi_MISC0[BlkPtr]` field is non-zero, up to 8 additional `MCi_MISCj` registers can be implemented for the error-reporting bank  $i$  (for a total of 9). These registers are allocated in contiguous blocks of 8, with `MCi_MISC1` addressed by:

$$\text{MCi\_MISC1 address} = \text{C000\_0400h} + (\text{MCi\_MISC0[BlkPtr]} \ll 3)$$

This is illustrated in Figure 9-7 below.

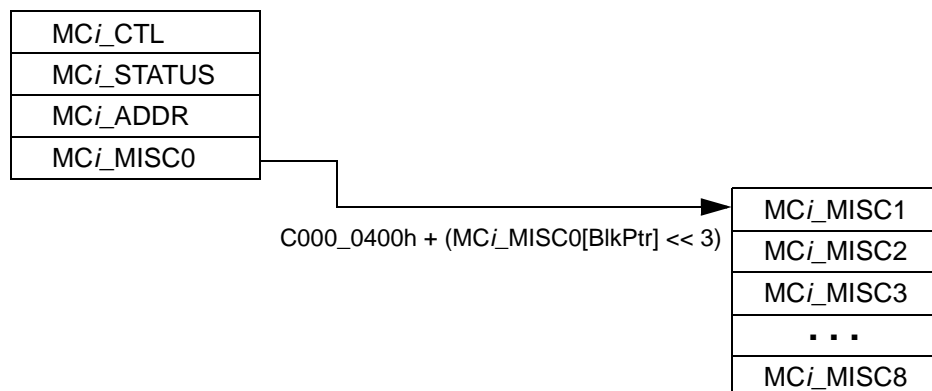

**Figure 9-7. `MCi_MISC1` Addressing**

The format of implemented `MCi_MISCj` registers depends upon their use and use can vary from one implementation to another. Figure 9-8 below illustrates the format of a miscellaneous error information register when used as an error thresholding register.

All miscellaneous error information registers will contain the VAL field in bit position 63. `MCi_MISC0` must contain the BLKP field in bits 31:24.

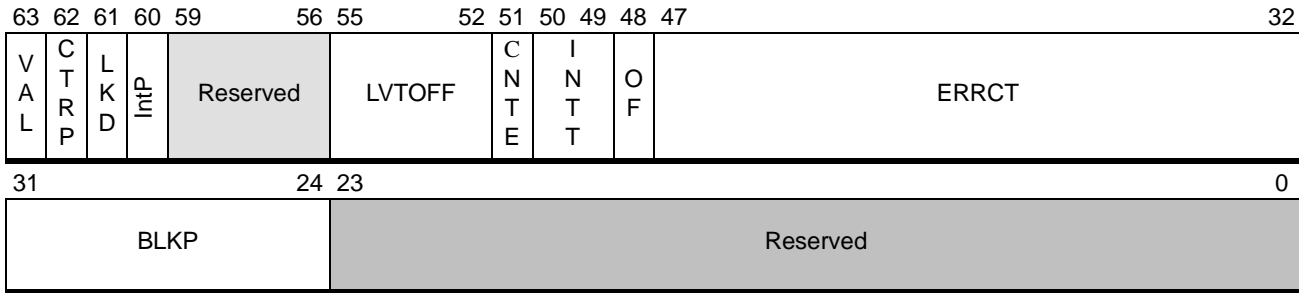

Bits	Mnemonic	Description	R/W	Reset
63	VAL	Valid	R	1b
62	CTRP	Counter Present	R	1b
61	LKD	Locked	R/W	0b
60	IntP	Thresholding Interrupt Supported	R	Xb
59:56	Reserved			
55:52	LVTOFF	LVT Offset	R/W	0000b
51	CNTE	Counter Enable	R/W	0b
50:49	INTT	Interrupt Type	R/W	00b
48	OF	Overflow	R/W	Xb
47:32	ERRCT	Error Counter	R/W	XXXXh
31:24	BLKP	Block pointer for additional MISC registers	R	
23:0	Reserved			

**Figure 9-8. Miscellaneous Information Register (Thresholding Register Format)**

The fields within the  $MCi\_MISCj$  register are:

- *Valid (VAL)*—Bit 63. When set to 1, indicates that the counter present (CTRP) and block pointer (BLKP) fields in this register are valid.
- *Counter Present (CTRP)*—Bit 62. When set to 1, indicates the presence of a threshold counter.
- *Locked (LKD)*—Bit 61. When set to 1, indicates that the threshold counter is not available for OS use. If this is the case, writes to bits 60:0 of this register are ignored and do not generate a fault. Software must check the Locked bit before writing into the thresholding register.  
This field is write-enabled by MSR C001\_0015h Hardware Configuration Register [MCSTATUSWrEn].
- *IntP (Thresholding Interrupt Supported)*—Bit 60. When set, this bit indicates that the reporting of threshold overflow via interrupt is supported. Interrupt type is determined by the setting of the INTT field.
- *LVT Offset (LVTOFF)*—Bits 55:52. This field specifies the address of the APIC LVT entry to deliver the threshold counter interrupt. Software must initialize the APIC LVT entry before enabling the threshold counter to generate the APIC interrupt; otherwise, undefined behavior may result.

$$APIC\ LVT\ address = (MCi\_MISCj[LvtOff] \ll 4) + 500h$$

- *Counter Enable (CNTE)*—Bit 51. When set to 1, counting of implementation-dependent errors is enabled; otherwise, counting is disabled.
- *Interrupt Type (INTT)*—Bits 50:49. The value of this field specifies the type of interrupt signaled when the value of the overflow bit changes from 0 to 1.
  - 00b = No interrupt
  - 01b = APIC-based interrupt
  - 10b = Reserved
  - 11b = Reserved
- *Overflow (OF)*—Bit 48. The value of this field is maintained through a warm reset. This bit is set by hardware when the error counter increments to its maximum implementation-supported value (from FFFEh to FFFFh for the maximum implementation-supported value). This is defined as the threshold level. When the overflow bit is set, the interrupt selected by the interrupt type field is generated. Software must reset this bit to zero in the interrupt handler routine when they update the error counter.
- *Error Counter (ERRCT)*—Bits 47:32. This field is maintained through a warm reset. The size of the threshold counter is implementation-dependent. Implementations with less than 16 bits fill the most significant unimplemented bits with zeros.

Software enumerates the counter bits to discover the size of the counter and the threshold level (when counter increments to the maximum count implemented). Software sets the starting error count as follows:

*Starting error count = threshold level – desired software error count to cause overflow*

The error counter is incremented by hardware when errors for the associated error counter are logged. When this counter overflows, it stays at the maximum error count (with no rollover).

- *Block pointer for additional MISC registers (BLKP)*—Bits 31:24. This field is only valid when valid (VAL) bit is set. When non-zero, this field is used to calculate a pointer to a contiguous block of eight MCI\_MISC MSR as follows:  $MCI\_MISC1 = (MCI\_MISC0[BlkPtr] \text{ shifted left 3 bits}) + C000\_0400h$ .

Other formats for miscellaneous information registers are implementation-dependent, see the *BIOS and Kernel Developer's Guide* applicable to your product for more details.

## 9.4 Initializing the Machine-Check Mechanism

Following a processor reset, all machine-check error-reporting enable bits are disabled. System software must enable these bits before machine-check errors can be reported. Generally, system software should initialize the machine-check mechanism using the following process:

- Execute the CPUID instruction and verify that the processor supports the machine-check exception (MCE) and machine-check registers (MCA). Software should not proceed with initializing the machine-check mechanism if the machine-check registers are not supported.
- If the machine-check registers are supported, system software should take the following steps:

- Check to see if the CTLP bit in the MCG\_CAP register is set to 1. If it is, then the MCG\_CTL register is supported by the processor. If the MCG\_CTL register is supported, software should set its enable bits to 1 for the machine-check features it uses. Software can load MCG\_CTL with all 1s to enable all available machine-check reporting banks.
- Read the COUNT field from the MCG\_CAP register to determine the number of error-reporting register banks supported by the processor. For each error-reporting register bank, software should set the enable bits to 1 in the MCI\_CTL register for the error types it wants the processor to report. Software can write each MCI\_CTL with all 1s to enable all error-reporting mechanisms.

Not enabling reporting banks that may be involved in the reporting of uncorrected errors can lead to the loss of system reliability and error recoverability.

- Check the VAL bit on each implemented MCI\_STATUS register. It is possible that valid error-status information has already been logged in the MCI\_STATUS registers at the time software is attempting to initialize them. The status can reflect errors logged prior to a warm reset or errors recorded during the system power-up and boot process. Before clearing the MCI\_STATUS registers, software should examine their contents and log any errors found.
  - After saving any valid error information contained in the MCI\_STATUS, MCI\_ADDR, and any implemented miscellaneous error information registers for each implemented reporting bank, software should clear all status fields in the MCI\_STATUS register for each bank by writing all 0s to the register.
- As a final step in the initialization process, system software should enable the machine-check exception by setting CR4[MCE] to 1.

A machine-check condition that occurs while CR4[MCE] is cleared will result in the processor core entering the shutdown state.

## 9.5 Using MCA Features

System software can detect and handle logged errors using three methods:

### 1. Polling

Software can periodically examine the machine-check status registers for errors, and save any error information found. Uncorrected errors found during polling will require some type of immediate response to initiate recovery or shutdown.

### 2. Enabling machine-check reporting

When reporting is enabled, any uncorrected error that occurs causes control to be transferred to the machine-check exception handler. The exception handler can be designed for a specific processor implementation or can be generalized to work on multiple implementations.

### 3. Setting up and enabling interrupts for deferred and corrected errors

In many implementations, MCA hardware can be configured to generate an interrupt hardware on the detection of a deferred error or when a programmed corrected error threshold is reached.

These methods are not mutually exclusive.

### 9.5.1 Determining the Scope of Detected Errors

Table 9-4 details the actions that recovery software should take and the level of recovery possible based on status information returned in the MCI\_STATUS and MCG\_STATUS registers.

**Table 9-4. Error Scope**

MCI_STATUS				MCG_STATUS		Error Scope
PCC	UC	Deferred	Poison	RIPV	EIPV	
1	1	—	—	—	—	System fatal error. Error has corrupted the processor core architectural state. System processing must be terminated.
0	1	—	—	1	1	Recoverable error. If software can correct the error, the interrupted program can be resumed.
0	1	—	0/1	0	—	Containable error. The interrupted instruction stream cannot be resumed. System-level recovery may be possible if software can localize the error and terminate any affected software processes. If Poison is set, the error was the result of the consumption of data tagged poison.
0	0	1	0	—	—	Deferred error. Immediate software action is not required. A latent error has been discovered, but not yet consumed. Error handling software may attempt to correct this data error, or prevent access by processes which map the data, or make the physical resource containing the data inaccessible.
0	0	0	0	—	—	Hardware corrected error. No software action is required. Error information should be saved for analysis.

### 9.5.2 Handling Machine Check Exceptions

The processor uses the interrupt control-transfer mechanism to invoke an exception handler after a machine-check exception occurs. This requires system software to initialize the interrupt-descriptor table (IDT) with either an interrupt gate or a trap gate that references the interrupt handler. See “Legacy Protected-Mode Interrupt Control Transfers” on page 237 and “Long-Mode Interrupt Control Transfers” on page 247 for more information on interrupt control transfers.

At a minimum, the machine-check exception handler must be capable of logging errors for later examination. This can be a sufficient implementation for some handlers. More thorough exception-handler implementations can analyze the error to determine if it is unrecoverable, and whether it can be recovered in software.

Machine-check exception handlers that attempt recovery must be thorough in their analysis and their corrective actions. The following guidelines should be used when writing such a handler:

- The status registers in all the enabled error-reporting register banks must be examined to identify the cause of the machine-check exception. Read the COUNT field from MCG\_CAP to determine the number of status registers supported by the processor.
- Check the valid bit in each status register ( $MCi\_STATUS[VAL]$ ). The  $MCi\_STATUS$  register does not need to be examined when its valid bit is clear.
- Check the valid  $MCi\_STATUS$  registers to see if error recovery is possible. Error recovery is not possible when:
  - The processor-context corrupt bit ( $MCi\_STATUS[PCC]$ ) is set to 1.
  - The error-overflow status bit ( $MCi\_STATUS[OVER]$ ) is set and the processor does not support recoverable  $MCi\_STATUS$  overflow (as indicated by feature bit  $CPUID Fn8000_0007\_EBX[McaOverflowRecov] = 0$ ).

If error recovery is not possible, the handler should log the error information and return to the system software responsible for shutting down the processor core.

- Check the  $MCi\_STATUS[UC]$  bit to see if the processor corrected the error. If UC is set, the processor did not correct the error and the exception handler must correct the error before restarting the interrupted program.

If the handler cannot correct the error or the  $MCG\_STATUS[RIPV]$  bit is cleared, it should not return control to the interrupted program, but should log the error information and terminate the software process that was about to consume the uncorrected data. If the error has compromised the state of a guest operating system, the guest should be restarted. If the state of the virtual machine has been corrupted, the virtual machine must be reinitialized.

- When identifying the error condition, portable exception handlers should examine only the architecturally defined fields of the  $MCi\_STATUS$  register.
- If the  $MCG\_STATUS[RIPV]$  bit is set, the interrupted program can be restarted reliably at the instruction pointer address pushed onto the exception handler stack. If  $RIPV = 0$ , the interrupted program cannot be restarted reliably at that location, although it can be restarted at that location for debugging purposes.
- When logging errors, particularly those that are not recoverable, check the  $MCG\_STATUS[EIPV]$  bit to see if the instruction-pointer address pushed onto the exception handler stack is related to the machine-check error. If  $EIPV = 0$ , the address is not guaranteed to be related to the error.
- Before exiting the machine-check handler, clear the  $MCG\_STATUS[MCIP]$  bit. MCIP indicates a machine-check exception occurred. If this bit is set when another machine-check exception occurs, the processor enters the shutdown state.
- When an exception handler is able to, at a minimum, successfully log an error condition, the  $MCi\_STATUS$  registers should be cleared before exiting the machine-check handler. Software is responsible for clearing at least the  $MCi\_STATUS[VAL]$  bits.
- Additional machine-check exception-handler portability can be added by having the handler use the CPUID instruction to identify the processor and its capabilities. Implementation-specific



software can be added to the machine-check exception handler based on the processor information reported by CPUID.

### 9.5.3 Reporting Corrected Errors

Machine-check exceptions do not occur if the error is corrected by the processor. If system software wishes to detect and save information concerning corrected machine-check errors, a system-service routine must be provided to check the contents of the machine-check status registers for corrected errors. The service routine can be invoked by system software on a periodic basis, or by an error-thresholding interrupt.

A service routine that gathers error information for corrected errors should perform the following:

- Examine the status register ( $MCi\_STATUS$ ) in each of the enabled error-reporting register banks. For each  $MCi\_STATUS$  register with a set valid bit ( $VAL=1$ ), the service routine should:
  - Save the contents of the  $MCi\_STATUS$  register.
  - Save the contents of the corresponding  $MCi\_ADDR$  register if  $MCi\_STATUS[ADDRV] = 1$ .
  - Save the contents of the corresponding  $MCi\_MISC$  register if  $MCi\_STATUS[MISCV] = 1$ .
- Once the information found in the error-reporting register banks is saved, the  $MCi\_STATUS$  register should be cleared. This allows the processor to properly report any subsequent errors in the  $MCi\_STATUS$  registers.
- The service routine can save the time-stamp counter with each error logged. This can help in determining how frequently errors occur. For further information, see “Time-Stamp Counter” on page 369.
- In multiprocessor configurations, the service routine can save the processor-node identifier. This can help locate a failing multiprocessor-system component, which can then be isolated from the rest of the system. For further information, see the documentation for particular implementations of the architecture.



## 10 System-Management Mode

---

System-management mode (SMM) is an operating mode designed for system-control activities like power management. Normally, these activities are transparent to conventional operating systems and applications. SMM is used by platform firmware and specialized low-level device drivers, rather than the operating system.

The SMM interrupt-handling mechanism differs substantially from the standard interrupt-handling mechanism described in Chapter 8, “Exceptions and Interrupts.” SMM is entered using a special external interrupt called the *system-management interrupt* (SMI). After an SMI is received by the processor, the processor saves the processor state in a separate address space, called *SMRAM*. The SMM-handler software and data structures are also located in the SMRAM space. Interrupts and exceptions that ordinarily cause control transfers to the operating system are disabled when SMM is entered. The processor exits SMM, restores the saved processor state, and resumes normal execution by using a special instruction, *RSM*.

In SMM, address translation is disabled and addressing is similar to real mode. SMM programs can address up to 4 Gbytes of physical memory. See “SMM Operating-Environment” on page 293 for additional information on memory addressing in SMM.

The following sections describe the components of the SMM mechanism:

- “*SMM Resources*” on page 284—this section describes SMRAM, the SMRAM save-state area used to hold the processor state, and special SMRAM save-state entries used in support of SMM.
- “*Using SMM*” on page 293—this section describes the mechanism of entering and exiting SMM. It also describes SMM memory allocation, addressing, and interrupts and exceptions.

Of these mechanisms, only the format of the SMRAM save-state area differs between the AMD64 architecture and the legacy architecture.

### 10.1 SMM Differences

There are functional differences between the SMM support in the AMD64 architecture and the SMM support found in previous architectures. These are:

- The SMRAM state-save area layout is changed to hold the 64-bit processor state.
- The initial processor state upon entering SMM is expanded to reflect the 64-bit nature of the processor.
- New conditions exist that can cause a processor shutdown while in SMM.
- The auto-halt restart and I/O-instruction restart entries in the SMRAM state-save area are one byte each instead of two bytes each.
- SMRAM caching considerations are modified because the legacy FLUSH# external signal (writeback, if modified, and invalidate) is not supported on implementations of the AMD64 architecture.

- Some previous AMD x86 processors saved and restored the CR2 register in the SMRAM state-save area. This register is not saved by the SMM implementation in the AMD64 architecture. SMM handlers that save and restore CR2 must perform the operation in software.

## 10.2 SMM Resources

The SMM resources supported by the processor consist of SMRAM, the SMRAM state-save area, and special entries within the SMRAM state-save area. In addition to the save-state area, SMRAM includes space for the SMM handler.

### 10.2.1 SMRAM

SMRAM is the memory-address space accessed by the processor when in SMM. The default size of SMRAM is 64 Kbytes and can range in size between 32 Kbytes and 4 Gbytes. System logic can use physically separate SMRAM and main memory, directing memory transactions to SMRAM after recognizing SMM is entered, and redirecting memory transactions back to system memory after recognizing SMM is exited. When separate SMRAM and main memory are used, the system designer needs to provide a method of mapping SMRAM into main memory so that the SMI handler and data structures can be loaded.

Figure 10-1 on page 285 shows the default SMRAM memory map. The default SMRAM code-segment (CS) has a base address of 0003\_0000h (the base address is automatically scaled by the processor using the CS-selector register, which is set to the value 3000h). This default SMRAM-base address is known as *SMBASE*. A 64-Kbyte memory region, addressed from 0003\_0000h to 0003\_FFFFh, makes up the default SMRAM memory space. The top 32 Kbytes (0003\_8000h to 0003\_FFFFh) must be supported by system logic, with physical memory covering that entire address range. The top 512 bytes (0003\_FE00h to 0003\_FFFFh) of this address range are the default *SMM state-save area*. The default entry point for the SMM interrupt handler is located at 0003\_8000h.

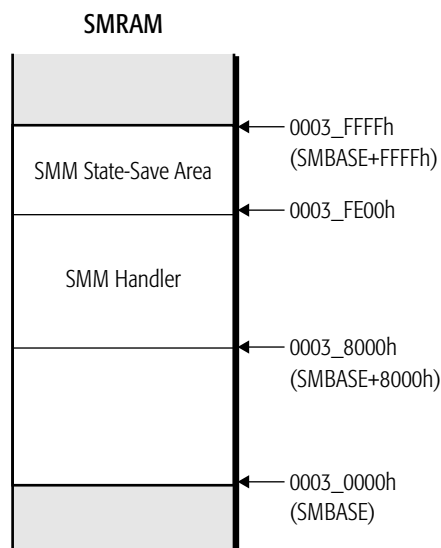

**Figure 10-1. Default SMRAM Memory Map**

### 10.2.2 SMBASE Register

The format of the SMBASE register is shown in Figure 10-2. SMBASE is an internal processor register that holds the value of the SMRAM-base address. SMBASE is set to 30000h after a processor reset.

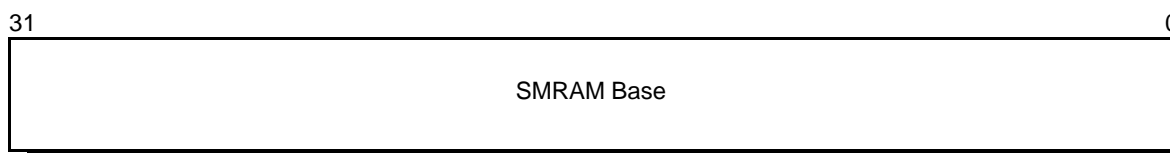

**Figure 10-2. SMBASE Register**

In some operating environments, relocation of SMRAM to a higher memory area can provide more low memory for legacy software. SMBASE relocation is supported when the SMM-base relocation bit in the SMM-revision identifier (bit 17) is set to 1. In processors implementing the AMD64 architecture, SMBASE relocation is always supported.

Software can only modify SMBASE (relocate the SMRAM-base address) by entering SMM, modifying the SMBASE image stored in the SMRAM state-save area, and exiting SMM. The SMM-

handler entry point must be loaded at the new memory location specified by SMBASE+8000h. The next time SMM is entered, the processor saves its state in the new state-save area at SMBASE+0FE00h, and begins executing the SMM handler at SMBASE+8000h. The new SMBASE address is used for every SMM until it is changed, or a hardware reset occurs.

When SMBASE is used to relocate SMRAM to an address above 1 Mbyte, 32-bit address-size-override prefixes must be used to access this memory. This is because addressing in SMM behaves as it does in real mode, with a 16-bit default operand size and address size. The values in the 16-bit segment-selector registers are left-shifted four bits to form a 20-bit segment-base address. Without using address-size overrides, the maximum computable address is 10FFEFh.

Because SMM memory-addressing is similar to real-mode addressing, the SMBASE address must be less than 4 Gbytes.

### 10.2.3 SMRAM State-Save Area

When an SMI occurs, the processor saves its state in the 512-byte SMRAM state-save area during the control transfer into SMM. The format of the state-save area defined by the AMD64 architecture is shown in Table 10-1. This table shows the offsets in the SMRAM state-save area relative to the SMRAM-base address. The state-save area is located between offset 0\_FE00h (SMBASE+0\_FE00h) and offset 0\_FFFFh (SMBASE+0\_FFFFh). Software should not modify offsets specified as read-only or reserved, otherwise unpredictable results can occur.

**Table 10-1. AMD64 Architecture SMM State-Save Area**

Offset (Hex) from SMBASE	Contents		Size	Allowable Access
FE00h	ES	Selector	Word	Read-Only
FE02h		Attributes	Word	
FE04h		Limit	Doubleword	
FE08h		Base	Quadword	
FE10h	CS	Selector	Word	Read-Only
FE12h		Attributes	Word	
FE14h		Limit	Doubleword	
FE18h		Base	Quadword	
FE20h	SS	Selector	Word	Read-Only
FE22h		Attributes	Word	
FE24h		Limit	Doubleword	
FE28h		Base	Quadword	
<b>Note:</b>				
1. The offset for the SMM-revision identifier is compatible with previous implementations.				

Table 10-1. AMD64 Architecture SMM State-Save Area (continued)

Offset (Hex) from SMBASE	Contents		Size	Allowable Access
FE30h	DS	Selector	Word	Read-Only
FE32h		Attributes	Word	
FE34h		Limit	Doubleword	
FE38h		Base	Quadword	
FE40h	FS	Selector	Word	Read-Only
FE42h		Attributes	Word	
FE44h		Limit	Doubleword	
FE48h		Base	Quadword	
FE50h	GS	Selector	Word	Read-Only
FE52h		Attributes	Word	
FE54h		Limit	Doubleword	
FE58h		Base	Quadword	
FE60h–FE63h	GDTR	Reserved	4 Bytes	Read-Only
FE64h		Limit	Word	
FE66h–FE67h		Reserved	2 Bytes	
FE68h		Base	Quadword	
FE70h	LDTR	Selector	Word	Read-Only
FE72h		Attributes	Word	
FE74h		Limit	Doubleword	
FE78h		Base	Quadword	
FE80h–FEB3h	IDTR	Reserved	4 Bytes	Read-Only
FE84h		Limit	Word	
FEB6h–FEB7h		Reserved	2 Bytes	
FE88h		Base	Quadword	
FE90h	TR	Selector	Word	Read-Only
FE92h		Attributes	Word	
FE94h		Limit	Doubleword	
FE98h		Base	Quadword	
FEA0h	I/O Instruction Restart RIP		Quadword	Read-Only
FEA8h	I/O Instruction Restart RCX		Quadword	Read-Only
FEB0h	I/O Instruction Restart RSI		Quadword	Read-Only
FEB8h	I/O Instruction Restart RDI		Quadword	Read-Only
FEC0h	I/O Instruction Restart Dword		Doubleword	Read-Only
FEC4h–FEC7h	Reserved		4 Bytes	—
<b>Note:</b>				
1. The offset for the SMM-revision identifier is compatible with previous implementations.				

Table 10-1. AMD64 Architecture SMM State-Save Area (continued)

Offset (Hex) from SMBASE	Contents	Size	Allowable Access
FEC8h	I/O Instruction Restart	Byte	Read/Write
FEC9h	Auto-Halt Restart	Byte	
FECAh—FECFh	Reserved	5 Bytes	—
FED0h	EFER	Quadword	Read-Only
FED8h	SVM Guest	Quadword	Read-Only
FEE0h	SVM Guest VMCB Physical Address	Quadword	
FEE8h	SVM Guest Virtual Interrupt	Quadword	
FEF0h—FEFBh	Reserved	10 Bytes	—
FEFCh	SMM-Revision Identifier <sup>1</sup>	Doubleword	Read-Only
FF00h	SMBASE	Doubleword	Read/Write
FF04h—FF1Fh	Reserved	27 Bytes	—
FF20h	SVM Guest PAT	Quadword	Read-Only
FF28h	SVM Host EFER	Quadword	
FF30h	SVM Host CR4	Quadword	
FF38h	SVM Host CR3	Quadword	
FF40h	SVM Host CR0	Quadword	
FF48h	CR4	Quadword	Read-Only
FF50h	CR3	Quadword	
FF58h	CR0	Quadword	
FF60h	DR7	Quadword	Read-Only
FF68h	DR6	Quadword	
FF70h	RFLAGS	Quadword	Read/Write
FF78h	RIP	Quadword	Read/Write
FF80h	R15	Quadword	
FF88h	R14	Quadword	
FF90h	R13	Quadword	
FF98h	R12	Quadword	
FFA0h	R11	Quadword	
FFA8h	R10	Quadword	
FFB0h	R9	Quadword	
FFB8h	R8	Quadword	
<b>Note:</b>			
1. The offset for the SMM-revision identifier is compatible with previous implementations.			



**Table 10-1. AMD64 Architecture SMM State-Save Area (continued)**

Offset (Hex) from SMBASE	Contents	Size	Allowable Access
FFC0h	RDI	Quadword	Read/Write
FFC8h	RSI	Quadword	
FFD0h	RBP	Quadword	
FFD8h	RSP	Quadword	
FFE0h	RBX	Quadword	
FFE8h	RDX	Quadword	
FFF0h	RCX	Quadword	
FFF8h	RAX	Quadword	
<b>Note:</b> 1. The offset for the SMM-revision identifier is compatible with previous implementations.			

A number of other registers are not saved or restored automatically by the SMM mechanism. See “Saving Additional Processor State” on page 295 for information on using these registers in SMM.

As a reference for legacy processor implementations, the legacy SMM state-save area format is shown in Table 10-2. *Implementations of the AMD64 architecture do not use this format.*

**Table 10-2. Legacy SMM State-Save Area (Not used by AMD64 Architecture)**

Offset (Hex) from SMBASE	Contents	Size	Allowable Access
FE00h—FEF7h	Reserved	248 Bytes	—
FEF8h	SMBASE	Doubleword	Read/Write
FEFCh	SMM-Revision Identifier	Doubleword	Read-Only
FF00h	I/O Instruction Restart	Word	Read/Write
FF02h	Auto-Halt Restart	Word	
FF04h—FF87h	Reserved	132 Bytes	—
FF88h	GDT Base	Doubleword	Read-Only
FF8Ch—FF93h	Reserved	Quadword	—
FF94h	IDT Base	Doubleword	Read-Only
FF98h—FFA7h	Reserved	16 Bytes	—
<b>Note:</b> 1. The offset for the SMM-revision identifier is compatible with previous implementations.			

**Table 10-2. Legacy SMM State-Save Area (Not used by AMD64 Architecture) (continued)**

Offset (Hex) from SMBASE	Contents	Size	Allowable Access
FFA8h	ES	Doubleword	Read-Only
FFACh	CS	Doubleword	
FFB0h	SS	Doubleword	
FFB4h	DS	Doubleword	
FFB8h	FS	Doubleword	
FFBCh	GS	Doubleword	
FFC0h	LDT Base	Doubleword	Read-Only
FFC4h	TR	Doubleword	
FFC8h	DR7	Doubleword	Read-Only
FFCCh	DR6	Doubleword	
FFD0h	EAX	Doubleword	Read/Write
FFD4h	ECX	Doubleword	
FFD8h	EDX	Doubleword	
FFDCh	EBX	Doubleword	
FFE0h	ESP	Doubleword	
FFE4h	EBP	Doubleword	
FFE8h	ESI	Doubleword	
FFECh	EDI	Doubleword	
FFF0h	EIP	Doubleword	Read/Write
FFF4h	EFLAGS	Doubleword	Read/Write
FFF8h	CR3	Doubleword	Read-Only
FFFCh	CR0	Doubleword	
<b>Note:</b>			
1. The offset for the SMM-revision identifier is compatible with previous implementations.			

### 10.2.4 SMM-Revision Identifier

The SMM-revision identifier specifies the SMM version and the available SMM extensions implemented by the processor. Software reads the SMM-revision identifier from offset FEFCh in the SMM state-save area of SMRAM. This offset location is compatible with earlier versions of SMM. Software must not write to this location. Doing so can produce undefined results. Figure 10-3 on page 291 shows the format of the SMM-revision identifier.

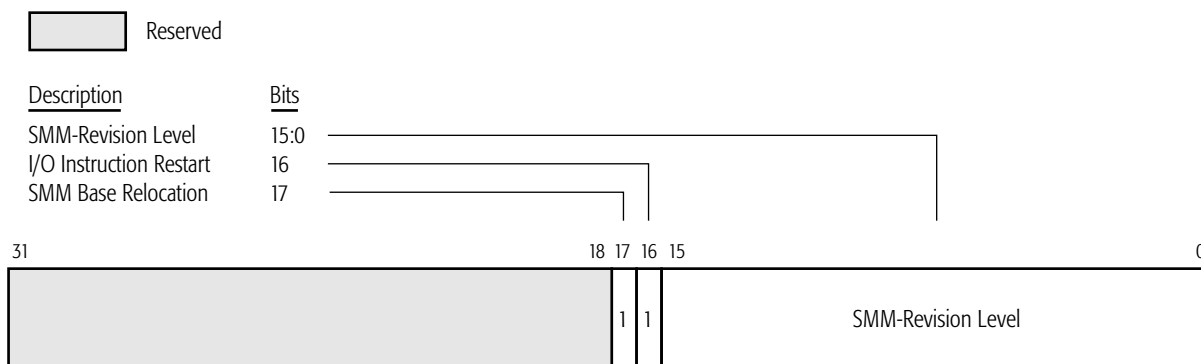

**Figure 10-3. SMM-Revision Identifier**

The fields within the SMM-revision identifier are:

- *SMM-revision Level*—Bits 15:0. Specifies the version of SMM supported by the processor. The SMM-revision level is of the form 0\_xx64h, where *xx* starts with 00 and is incremented for later revisions to the SMM mechanism.
- *I/O Instruction Restart*—Bit 16. When set to 1, the processor supports restarting I/O instructions that are interrupted by an SMI. This bit is always set to 1 by implementations of the AMD64 architecture. See “I/O Instruction Restart” on page 297 for information on using this feature.
- *SMM Base Relocation*—Bit 17. When set to 1, the processor supports relocation of SMRAM. This bit is always set to 1 by implementations of the AMD64 architecture. See “SMBASE Register” on page 285 for information on using this feature.

All remaining bits in the SMM-revision identifier are reserved.

### 10.2.5 SMRAM Protected Area

Two areas are provided as safe areas for SMM code and data that are not readily accessible by non-SMM applications. The SMI handler can be located in one of these two ranges, or it can be located outside of these ranges.

The ASeg range is located at a fixed address from A\_0000h to B\_FFFFh. The TSeg range is located at a variable base specified by the SMM\_ADDR MSR with a variable size specified by the SMM\_MASK MSR. These ranges must never overlap.

Each CPU memory access is in the TSeg range if the following is true:

$$\text{Phys Addr}[51:17] \& \text{SMM\_MASK}[51:17] = \text{SMM\_ADDR}[51:17] \& \text{SMM\_MASK}[51:17].$$

For example, if the TSeg range spans 256 Kbytes starting at address 10\_0000h, then SMM\_ADDR =0010\_0000h and SMM\_MASK=FFFC\_0000h (with zeros in bits 16:0). This results in a TSeg address range from 0010\_0000 to 0013\_FFFFh.

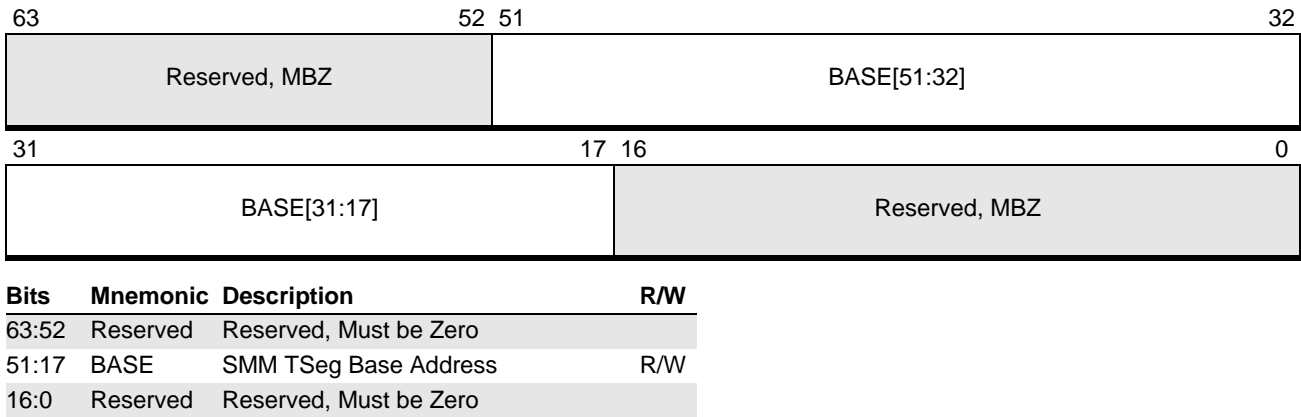

Figure 10-4. SMM\_ADDR Register Format

- *SMM TSeg Base Address (BASE)*—Bits 51:17. Specifies the base address of the TSeg range of protected addresses.

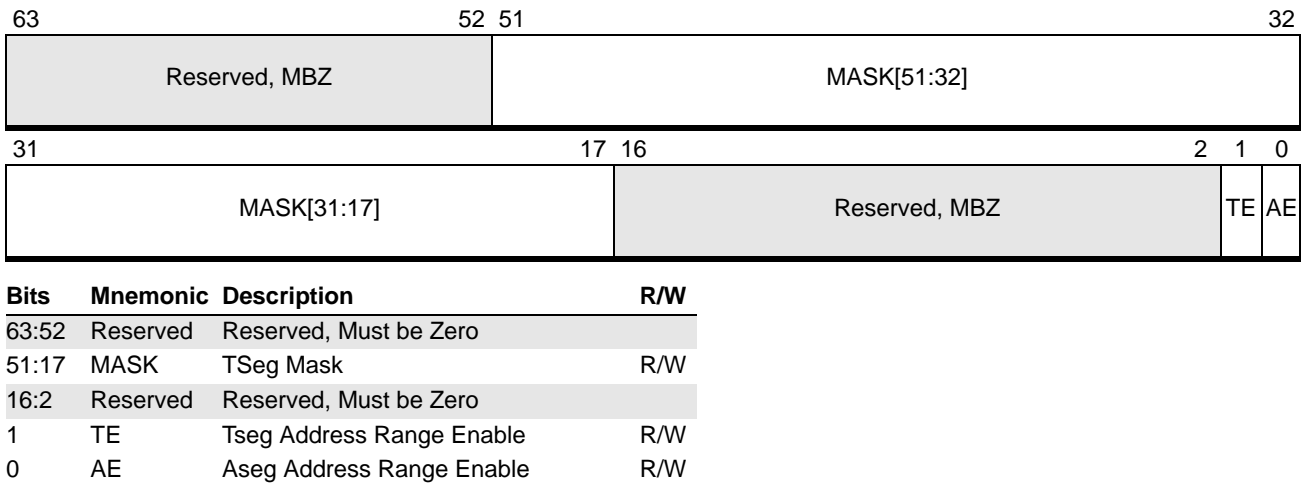

Figure 10-5. SMM\_MASK Register Format

- *ASeg Address Range Enable (AE)*—Bit 0. Specifies whether the ASeg address range is enabled for protection. When the bit is set to 1, the ASeg address range is enabled for protection. When cleared to 0, the ASeg address range is disabled for protection.

- *TSeg Address Range Enable (TE)*—Bit 1. Specifies whether the TSeg address range is enabled for protection. When the bit is set to 1, the TSeg address range is enabled for protection. When cleared to 0, the TSeg address range is disabled for protection.
- *TSeg Mask (MASK)*—Bits 51:17. Specifies the mask used to determine the TSeg range of protected addresses. The physical address is in the TSeg range if the following is true:  

$$\text{Phys Addr}[51:17] \& \text{SMM\_MASK}[51:17] = \text{SMM\_ADDR}[51:17] \& \text{SMM\_MASK}[51:17].$$

Note that a processor is not required to implement all 52 bits of the physical address.

## 10.3 Using SMM

### 10.3.1 System-Management Interrupt (SMI)

SMM is entered using the system-management interrupt (SMI). SMI is an external non-maskable interrupt that operates differently from and independently of other interrupts. SMI has priority over all other external interrupts, including NMI (see “Priorities” on page 232 for a list of the interrupt priorities). SMIs are disabled when in SMM, which prevents reentrant calls to the SMM handler.

When an SMI is received by the processor, the processor stops fetching instructions and waits for currently-executing instructions to complete and write their results. The SMI also waits for all buffered memory writes to update the caches or system memory. When these activities are complete, the processor uses implementation-dependent external signaling to acknowledge back to the system that it has received the SMI.

### 10.3.2 SMM Operating-Environment

The SMM operating-environment is similar to real mode, except that the segment limits in SMM are 4 Gbytes rather than 64 Kbytes. This allows an SMM handler to address memory in the range from 0h to 0FFFF\_FFFFh. As with real mode, segment-base addresses are restricted to 20 bits in SMM, and the default operand-size and address-size is 16 bits. To address memory locations above 1 Mbyte, the SMM handler must use the 32-bit operand-size-override and address-size-override prefixes.

After saving the processor state in the SMRAM state-save area, a processor running in SMM sets the segment-selector registers and control registers into a state consistent with real mode. Other registers are also initialized upon entering SMM, as shown in Table 10-3.

**Table 10-3. SMM Register Initialization**

Register		Initial SMM Contents
CS	Selector	SMBASE right-shifted 4 bits
	Base	SMBASE
	Limit	FFFF_FFFFh
	Attr	Read-Write-Execute

**Table 10-3. SMM Register Initialization (continued)**

Register		Initial SMM Contents
DS, ES, FS, GS, SS	Selector	0000h
	Base	0000_0000_0000_0000h
	Limit	FFFF_FFFFh
	Attr	Read-Write
RIP		0000_0000_0000_8000h
RFLAGS		0000_0000_0000_0002h
CR0		PE, EM, TS, PG bits cleared to 0. All other bits are unmodified.
CR4		0000_0000_0000_0000h
DR7		0000_0000_0000_0400h
EFER		0000_0000_0000_0000h

### 10.3.3 Exceptions and Interrupts

All hardware interrupts are disabled upon entering SMM, but exceptions and software interrupts are not disabled. If necessary, the SMM handler can re-enable hardware interrupts. Software that handles interrupts in SMM should consider the following:

- *SMI*—If an SMI occurs while the processor is in SMM, it is latched by the processor. The latched SMI occurs when the processor leaves SMM.
- *NMI*—If an NMI occurs while the processor is in SMM, it is latched by the processor, but the NMI handler is not invoked until the processor leaves SMM with the execution of an RSM instruction. A pending NMI causes the handler to be invoked immediately after the RSM completes and before the first instruction in the interrupted program is executed.

An SMM handler can unmask NMI interrupts by simply executing an IRET. Upon completion of the IRET instruction, the processor recognizes the pending NMI, and transfers control to the NMI handler. Once an NMI is recognized within SMM using this technique, subsequent NMIs are recognized until SMM is exited. Later SMIs cause NMIs to be masked, until the SMM handler un masks them.

- *Exceptions*—Exceptions (internal processor interrupts) are not disabled and can occur while in SMM. Therefore, the SMM-handler software should be written to avoid generating exceptions.
- *Software Interrupts*—The software-interrupt instructions (BOUND, INT $n$ , INT3, and INTO) can be executed while in SMM. However, it is not recommended that the SMM handler use these instructions.
- *Maskable Interrupts*—RFLAGS.IF is cleared to 0 by the processor when SMM is entered. Software can re-enable maskable interrupts while in SMM, but it must follow the guidelines listed below for handling interrupts.
- *Debug Interrupts*—The processor disables the debug interrupts when SMM is entered by clearing DR7 to 0 and clearing RFLAGS.TF to 0. The SMM handler can re-enable the debug facilities while in SMM, but it must follow the guidelines listed below for handling interrupts.

- *INIT*—The processor does not recognize *INIT* while in SMM.

Because the *RFLAGS.IF* bit is cleared when entering SMM, the *HLT* instruction should not be executed in SMM without first setting the *RFLAGS.IF* bit to 1. Setting this bit to 1 allows the processor to exit the halt state by using an external maskable interrupt.

In the cases where an SMM handler must accept and handle interrupts and exceptions, several guidelines must be followed:

- Interrupt handlers must be loaded and accessible before enabling interrupts.
- A real-mode interrupt vector table located at virtual (linear) address 0 is required.
- Segments accessed by the interrupt handler cannot have a base address greater than 20 bits because of the real-mode addressing used in SMM. In SMM, the 16-bit value stored in the segment-selector register is left-shifted four bits to form the 20-bit segment-base address, like real mode.
- Only the *IP* (*rIP*[15:0]) is pushed onto the stack as a result of an interrupt in SMM, because of the real-mode addressing used in SMM. If the SMM handler is interrupted at a code-segment offset above 64 Kbytes, then the return address on the stack must be adjusted by the interrupt-handler, and a *RET* instruction with a 32-bit operand-size override must be used to return to the SMM handler.
- If the interrupt-handler is located below 1 Mbyte, and the SMM handler is located above 1 Mbyte, a *RET* instruction cannot be used to return to the SMM handler. In this case, the interrupt handler can adjust the return pointer on the stack, and use a far *CALL* to transfer control back to the SMM handler.

### 10.3.4 Invalidating the Caches

The processor can cache SMRAM-memory locations. If the system implements physically separate SMRAM and system memory, it is possible for SMRAM and system memory locations to alias into identical cache locations. In some processor implementations, the cache contents must be written to memory and invalidated when SMM is entered *and* exited. This prevents the processor from using previously-cached main-memory locations as aliases for SMRAM-memory locations when SMM is entered, and vice-versa when SMM is exited.

Implementations of the AMD64 architecture *do not require cache invalidation* when entering and exiting SMM. Internally, the processor keeps track of SMRAM and system-memory accesses separately and properly handles situations where aliasing occurs. Cached system memory and SMRAM locations can persist across SMM mode changes. Removal of the requirement to writeback and invalidate the cache simplifies SMM entry and exit and allows SMM code to execute more rapidly.

### 10.3.5 Saving Additional Processor State

Several registers are not saved or restored automatically by the SMM mechanism. These are:

- The 128-bit media instruction registers.
- The 64-bit media instruction registers.

- The x87 floating-point registers.
- The page-fault linear-address register (CR2).
- The task-priority register (CR8).
- The debug registers, DR0, DR1, DR2, and DR3.
- The memory-type range registers (MTRRs).
- Model-specific registers (MSRs).

These registers are not saved because SMM handlers do not normally use or modify them. If an SMI results in a processor reset (due to powering down the processor, for example) or the SMM handler modifies the contents of the unsaved registers, the SMM handler should save and restore the original contents of those registers. The unsaved registers, along with those stored in the SMRAM state-save area, need to be saved in a non-volatile storage location if a processor reset occurs. The SMM handler should execute the CPUID instruction to determine the feature set available in the processor, and be able to save and restore the registers required by those features. For more information on using the CPUID instruction, see Section 3.3, “Processor Feature Identification,” on page 63.

The SMM handler can execute any of the 128-bit media, 64-bit media, or x87 instructions. A simple method for saving and restoring those registers is to use the FXSAVE and FXRSTOR instructions, respectively, if it is supported by the processor. See “Saving Media and x87 Execution Unit State” on page 308 for information on saving and restoring those registers.

Floating-point exceptions can occur when the SMM handler uses media or x87 floating-point instructions. If the SMM handler uses floating-point exception handlers, they must follow the usage guidelines established in “Exceptions and Interrupts” on page 294. A simple method for dealing with floating-point exceptions while in SMM is to simply mask all exception conditions using the appropriate floating-point control register. When the exceptions are masked, the processor handles floating-point exceptions internally in a default manner, and allows execution to continue uninterrupted.

### 10.3.6 Operating in Protected Mode and Long Mode

Software can enable protected mode from SMM and it can also enable and activate long mode. An SMM handler can use this capability to enter 64-bit mode and save additional processor state that cannot be accessed from outside 64-bit mode (for example, the most-significant 32 bits of CR2).

### 10.3.7 Auto-Halt Restart

The auto-halt restart entry is located at offset FEC9h in the SMM state-save area. The size of this field is one byte, as compared with two bytes in previous versions of SMM.

When entering SMM, the processor loads the auto-halt restart entry to indicate whether SMM was entered from the halt state, as follows:

- Bit 0 indicates the processor state upon entering SMM:
  - When set to 1, the processor entered SMM from the halt state.



- When cleared to 0, the processor did not enter SMM from the halt state.
- Bits 7:1 are cleared to 0.

The SMM handler can write the auto-halt restart entry to specify whether the return from SMM should take the processor back to the halt state or to the instruction-execution state specified by the SMM state-save area. The values written are:

- *Clear to 00h*—The processor returns to the state specified by the SMM state-save area.
- *Set to any non-zero value*—The processor returns to the halt state.

If the return from SMM takes the processor back to the halt state, the HLT instruction is not re-executed. However, the halt special bus-cycle is driven on the processor bus after the RSM instruction executes.

The result of entering SMM from a non-halt state and returning to a halt state is not predictable.

### 10.3.8 I/O Instruction Restart

The I/O-instruction restart entry is located at offset FEC8h in the SMM state-save area. The size of this field is one byte, as compared with two bytes in previous versions of SMM. The I/O-instruction restart mechanism is supported when the I/O-instruction restart bit (bit 16) in the SMM-revision identifier is set to 1. This bit is always set to 1 in the AMD64 architecture.

When an I/O instruction is interrupted by an SMI, the I/O-instruction restart entry specifies whether the interrupted I/O instruction should be re-executed following an RSM that returns from SMM. Re-executing a trapped I/O instruction is useful, for example, when an I/O write is performed to a powered-down disk drive. When this occurs, the system logic monitoring the access can issue an SMI to have the SMM handler power-up the disk drive and retry the I/O write. The SMM handler does this by querying system logic and detecting the failed I/O write, asking system logic to initiate the disk-drive power-up sequence, enabling the I/O instruction restart mechanism, and returning from SMM. Upon returning from SMM, the I/O write to the disk drive is restarted.

When an SMI occurs, the processor always clears the I/O-instruction restart entry to 0. If the SMI interrupted an I/O instruction, then the SMM handler can modify the I/O-instruction restart entry as follows:

- *Clear to 00h (default value)*—The I/O instruction is not restarted, and the instruction following the interrupted I/O-instruction is executed. When a REP (repeat) prefix is used with an I/O instruction, it is possible that the next instruction to be executed is the next I/O instruction in the repeat loop.
- *Set to any non-zero value*—The I/O instruction is restarted.

While in SMM, the handler must determine the cause of the SMI and examine the processor state at the time the SMI occurred to determine whether or not an I/O instruction was interrupted.

Implementations provide state information in the SMM save-state area to assist in this determination:

- **I/O Instruction Restart DWORD**—indicates whether the SMI interrupted an I/O instruction, and saves extra information describing the I/O instruction.



- Any DR6 bit or DR7 bit in the range 63:32 is set to 1.
- Any unsupported bit in EFER is set to 1.
- Invalid returns to long mode, including:
  - EFER.LME=1, CR0.PG=1, and CR4.PAE=0.
  - EFER.LME=1, CR0.PG=1, CR4.PAE=1, CS.L=1, and CS.D=1.
- The SSM revision identifier is modified.

Some SMRAM state-save-area conditions are ignored, and the registers, or bits within the registers, are restored in a default manner by the processor. This avoids a processor shutdown when an invalid condition is stored in SMRAM. The default conditions restored by the processor are:

- The EFER.LMA register bit is set to the value obtained by logically ANDing the SMRAM values of EFER.LME, CR0.PG, and CR4.PAE.
- The rFLAGS.VM register bit is set to the value obtained by logically ANDing the SMRAM values of rFLAGS.VM, CR0.PE, and the inverse of EFER.LMA.
- The base values of FS, GS, GDTR, IDTR, LDTR, and TR are restored in canonical form. Those values are sign-extended to bit 63 using the most-significant implemented bit.
- Unimplemented segment-base bits in the CS, DS, ES, and SS registers are cleared to 0.



## 11 SSE, MMX, and x87 Programming

---

This chapter describes the system-software implications of supporting applications that use the Streaming SIMD Extensions (SSE), MMX™, and x87 instructions. Throughout this chapter, these instructions are collectively referred to as *media and x87* (media/x87) instructions. A complete listing of the instructions that fall in this category—and the detailed operation of each instruction—can be found in volumes 4 and 5. Refer to Volume 1 for information on using these instructions in application software.

The SSE instruction set is comprised of the *legacy SSE* instruction set which includes the SSE1, SSE2, SSE3, SSSE3, SSE4A, SSE4.1, and SSE4.2 subsets and the *extended SSE* instruction set which includes the AVX, FMA4, and XOP subsets. Many of the extended SSE instructions support both 128-bit and 256-bit data types.

### 11.1 Overview of System-Software Considerations

Processor implementations can support different combinations of the SSE, MMX, and x87 instruction sets. Two sets of registers—independent of the general-purpose registers—support these instructions. The SSE instructions operate on the YMM/XMM registers, and the 64-bit media and x87-instructions operate on the aliased MMX/x87 registers. The SSE and x87 floating-point instruction sets have distinct status registers, control registers, exception vectors, and system-software control bits for managing the operating environment. System software that supports use of these instructions must be able to manage these resources properly including:

- Detecting support for the instruction set, and enabling any optional features, as necessary.
- Saving and restoring the processor media or x87 state.
- Execution of floating-point instructions (media or x87) can produce exceptions. System software must supply exception handlers for all unmasked floating-point exceptions.

### 11.2 Determining Media and x87 Feature Support

Support for the architecturally defined subsets within the media and x87 instructions is implementation dependent. System software executes the CPUID instruction to determine whether a processor implements any of these features (see Section 3.3, “Processor Feature Identification,” on page 63 for more information on using the CPUID instruction). After CPUID is executed feature support can be determined by examining specific bit fields returned in the EAX, ECX, and EDX registers.

The following table summarizes the architecturally defined SSE subsets and state management instructions and gives the feature bits returned by the CPUID function. If the indicated bit is set, the feature is supported by the processor.

Table 11-1. SSE Subsets - CPUID Feature Identifiers

CPUID Fn	Field Name	Field Bit	Instruction Subset
<b>Legacy SSE</b>			
0000_0001h	EDX[SSE]	EDX[25]	Original Streaming SIMD Extensions (SSE1)
0000_0001h	EDX[SSE2]	EDX[26]	SSE2
0000_0001h	ECX[SSE3]	ECX[0]	SSE3
0000_0001h	ECX[SSSE3]	ECX[9]	SSSE3
0000_0001h	ECX[SSE41]	ECX[19]	SSE4.1
0000_0001h	ECX[SSE42]	ECX[20]	SSE4.2
8000_0001h	ECX[SSE4A]	ECX[6]	SSE4A: EXTRQ, INSERTQ, MOVNTSS, and MOVNTSD instructions
<b>Extended SSE</b>			
0000_0001h	ECX[AVX]	ECX[28]	AVX
8000_0001h	ECX[XOP]	ECX[11]	AMD XOP
0000_0001h	ECX[FMA]	ECX[12]	FMA
8000_0001h	ECX[FMA4]	ECX[16]	AMD FMA4
<b>MMX</b>			
0000_0001h or 8000_0001h	EDX[MMX]	EDX[23]	Original MMX™ Instructions
8000_0001h	EDX[MmxExt]	EDX[22]	AMD Extensions to MMX
8000_0001h	EDX[3DNow]	EDX[31]	AMD 3DNow!™
8000_0001h	EDX[3DNowExt]	EDX[30]	AMD Extensions to 3DNow!
<b>x87</b>			
0000_0001h or 8000_0001h	EDX[FPU]	EDX[0]	x87 instruction set and facilities
<b>Context Management Instructions</b>			
0000_0001h or 8000_0001h	EDX[FXSR]	EDX[24]	FXSAVE / FXRSTOR instructions
8000_0001h	EDX[FFXSR]	EDX[25]	Hardware optimizations for FXSAVE / FXRSTOR
0000_0001h	ECX[XSAVE]	ECX[26]	XSAVE / XRSTOR instructions
0000_000Dh ECX=01h	EAX[XSAVEOPT]	EAX[0]	XSAVEOPT

Some instructions may be listed in more than one subset. If software attempts to execute an instruction belonging to an unsupported instruction subset, an invalid-opcode exception (#UD) occurs. Refer to Appendix D, “Instruction Subsets and CPUID Feature Flags” in Volume 3 for specific information.

## 11.3 Enabling SSE Instructions

Use of the 256-bit and 128-bit media instructions by application software requires system software support. System software must determine which SSE subsets are supported, enable those that are to be used, and supply code to handle the various exceptions that may occur during the execution of these instructions. The legacy SSE instructions and the extended SSE instructions often require unique exception handling.

### 11.3.1 Enabling Legacy SSE Instruction Execution

When legacy SSE instructions are supported, system software must set CR4.OSFXSR to let the processor know that the software supports the FXSAVE/FXRSTOR instructions. When the processor detects CR4.OSFXSR = 1, it allows execution of the legacy SSE instructions. If system software does not set CR4.OSFXSR, any attempt to execute these instructions causes an invalid-opcode exception (#UD). System software must also *clear* the CR0.EM (emulate coprocessor) bit to 0, otherwise an attempt to execute a legacy SSE instruction causes a #UD exception. An attempt to execute either FXSAVE or FXRSTOR when CR0.EM is set results in a #NM exception.

System software should also *set* the CR0.MP (monitor coprocessor) bit to 1. When CR0.EM=0 and CR0.MP=1, all media instructions, x87 instructions, and the FWAIT/WAIT instructions cause a device-not-available exception (#NM) when the CR0.TS bit is set. System software can use the #NM exception to perform lazy context switching, saving and restoring media and x87 state only when necessary after a task switch. See “CR0 Register” on page 42 for more information.

### 11.3.2 Enabling Extended SSE Instruction Execution

After the steps specified above are completed to enable legacy SSE instruction execution, additional steps are required to enable the extended SSE instructions and state management. System software must carry out the following process:

- Confirm that the hardware supports the XSAVE, XRSTOR, XSETBV, and XGETBV instructions and the XCR0 register (XFEATURE\_ENABLED\_MASK) by executing the CPUID instruction function 0000\_0001h. If CPUID Fn0000\_0001\_ECX[XSAVE] is set, hardware support is verified.
- Optionally confirm hardware support of the XSAVEOPT instruction by executing CPUID function 0000\_000Dh, sub-function 1 (ECX = 1). If CPUID Fn0000\_000D\_EAX\_x1[XSAVEOPT] is set, the processor supports the XSAVEOPT instruction. XSAVEOPT is a performance optimized version of XSAVE.
- Confirm that hardware supports the extended SSE instructions by verifying XFeatureSupportedMask[2:0] = 111b. XFeatureSupportedMask is accessed via the CPUID instruction function 0000\_000Dh, sub-function 0 (ECX = 0). XFeatureSupportedMask[31:0] is returned in the EAX register.

If CPUID Fn0000\_000D\_EAX\_x0[2:0] = 111b, hardware supports x87, legacy SSE, and extended SSE instructions. Bit 0 of EAX signifies x87 floating-point and MMX support, bit 1 signifies legacy SSE support, and bit 2 signifies extended SSE support. Support for both x87 and legacy SSE instructions are required for processors that support the extended SSE instructions.

- Set CR4[OSXSAVE] (bit 18) to enable the use of the XSETBV and XGETBV instructions. XSETBV is a privileged instruction that writes the XCRn registers. XCR0 is the XFEATURE\_ENABLED\_MASK used to manage media and x87 processor state using the XSAVE, XSAVEOPT, and XRSTOR instructions.
- Enable the x87/MMX, legacy SSE, and extended SSE instructions and processor state management by setting the x87, SSE, and YMM bits of XCR0 (XFEATURE\_ENABLED\_MASK). This is done via the privileged instruction XSETBV. Enabling extended SSE capabilities without enabling legacy SSE capabilities is not allowed. The x87 flag (bit 0) of the XFEATURE\_ENABLED\_MASK must be set when writing XCR0.
- Determine the XSAVE/XRSTOR memory save area size requirement. The field XFeatureEnabledSizeMax specifies the size requirement in bytes based on the currently enabled extended features and is returned in the EBX register after execution of CPUID Function 0000\_000Dh, sub-function 0 (ECX = 0).
- Allocate the save/restore area based on the information obtained in the previous step.

For a detailed description of the XSETBV and XGETBV instructions, see individual instruction reference pages in Volume 4. See the section entitled “XFEATURE\_ENABLED\_MASK” in Volume 4 for details on the field definitions for XFEATURE\_ENABLED\_MASK.

For more information on using the CPUID instruction to obtain processor feature information, see Section 3.3, “Processor Feature Identification,” on page 63.

### 11.3.3 SIMD Floating-Point Exception Handling

System software must supply an exception handler if unmasked SSE floating-point exceptions are allowed to occur. When an unmasked exception is detected, the processor transfers control to the SIMD floating-point exception (#XF) handler provided by the operating system. System software must let the processor know that the #XF handler is available by setting CR4.OSXMMEXCPT to 1. If this bit is set to 1, the processor transfers control to the #XF handler when it detects an unmasked exception, otherwise a #UD exception occurs. When the processor detects a masked exception, it handles it in a default manner regardless of the CR4.OSXMMEXCPT value.

## 11.4 Media and x87 Processor State

The media and x87 processor state includes the contents of the registers used by SSE, MMX, and x87 instructions. System software that supports such applications must be capable of saving and restoring these registers.

### 11.4.1 SSE Execution Unit State

Figure 11-1 shows the registers whose contents are affected by execution of SSE instructions. These include:

- YMM/XMM0–15—Sixteen 256-bit/128-bit SSE registers. In legacy and compatibility modes, software access is limited to the first eight registers.



- MXCSR—The 32-bit Media eXtensions Control and Status Register.

All of these registers are visible to application software. Refer to “Streaming SIMD Extensions Media and Scientific Programming” in Volume 1 for more information on these registers.

255	127	0
	XMM0	YMM0
	XMM1	YMM1
	XMM2	YMM2
	XMM3	YMM3
	XMM4	YMM4
	XMM5	YMM5
	XMM6	YMM6
	XMM7	YMM7
	XMM8	YMM8
	XMM9	YMM9
	XMM10	YMM10
	XMM11	YMM11
	XMM12	YMM12
	XMM13	YMM13
	XMM14	YMM14
	XMM15	YMM15

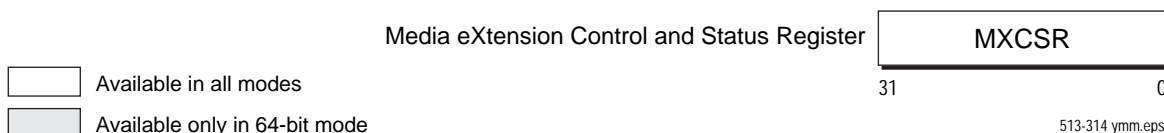

**Figure 11-1. SSE Execution Unit State**

### 11.4.2 MMX Execution Unit State

Figure 11-2 on page 306 shows the register contents that are affected by execution of 64-bit media instructions. These registers include:

- *mmx0–mmx7*—Eight 64-bit media registers.
- *FSW*—Two fields (TOP and ES) in the 16-bit x87 status word register.

- *FTW*—The 16-bit x87 tag word.

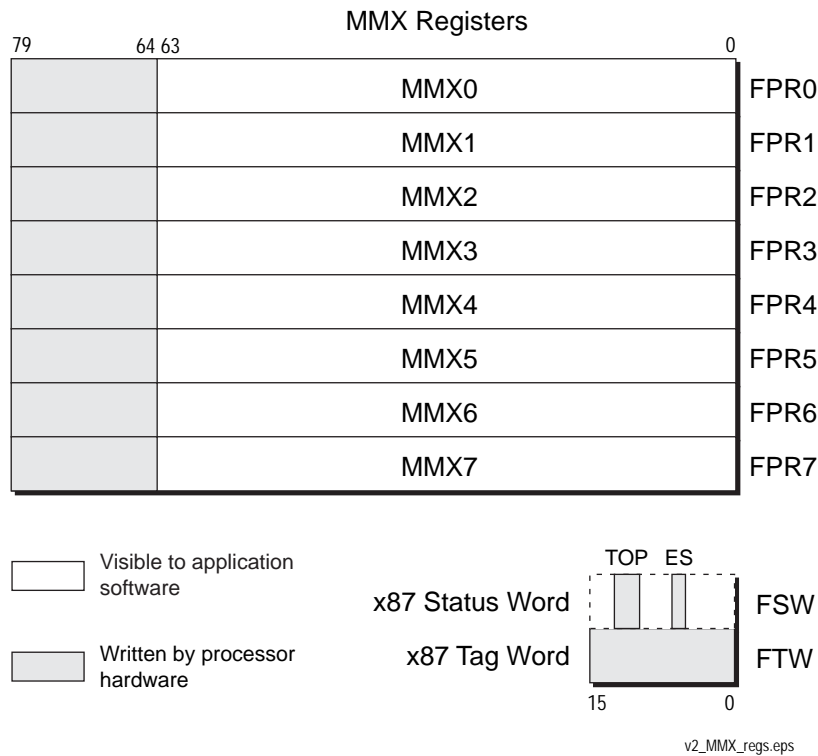

**Figure 11-2. MMX Execution Unit State**

The 64-bit media instructions and x87 floating-point instructions share the same physical data registers. Figure 11-2 shows how the 64-bit registers (MMX0–MMX7) are aliased onto the low 64 bits of the 80-bit x87 floating-point physical data registers (FPR0–FPR7). Refer to “64-Bit Media Programming” in Volume 1 for more information on these registers.

Of the registers shown in Figure 11-2, only the eight 64-bit MMX registers are visible to 64-bit media application software. The processor maintains the contents of the two fields of the x87 status word—top-of-stack-pointer (TOP) and exception summary (ES)—and the 16-bit x87 tag word during execution of 64-bit media instructions, as described in “Actions Taken on Executing 64-Bit Media Instructions” in Volume 1.

64-bit media instructions do not generate x87 floating-point exceptions, nor do they set any status flags. However, 64-bit media instructions can trigger an unmasked floating-point exception caused by a previously executed x87 instruction. 64-bit media instructions do this by reading the x87 FSW.ES bit to determine whether such an exception is pending.

### 11.4.3 x87 Execution Unit State

Figure 11-3 on page 308 shows the registers whose contents are affected by execution of x87 floating-point instructions. These registers include:

- *fpr0–fpr7*—Eight 80-bit floating-point physical registers.
- *FCW*—The 16-bit x87 control word register.
- *FSW*—The 16-bit x87 status word register.
- *FTW*—The 16-bit x87 tag word.
- *Last x87 Instruction Pointer*—This value is a pointer (32-bit, 48-bit, or 64-bit, depending on effective operand size and mode) to the last non-control x87 floating-point instruction executed.
- *Last x87 Data Pointer*—The pointer (32-bit, 48-bit, or 64-bit, depending on effective operand size and mode) to the data operand referenced by the last non-control x87 floating-point instruction executed, if that instruction referenced memory; if it did not, then this value is implementation dependent.
- *Last x87 Opcode*—An 11-bit permutation of the instruction opcode from the last non-control x87 floating-point instruction executed.

Of the registers shown in Figure 11-3 on page 308, only *FPR0–FPR7*, *FCW*, and *FSW* are directly updated by x87 application software. The processor maintains the contents of the *FTW*, instruction and data pointers, and opcode registers during execution of x87 instructions. Refer to “Registers” in Volume 1 for more information on these registers.

The 11-bit instruction opcode register holds a permutation of the two-byte instruction opcode from the last non-control x87 instruction executed by the processor. (For a definition of *non-control x87 instruction*, see “Control” in Chapter 6 of Volume 1.) The opcode field is formed as follows:

- Opcode Register Field[10:8] = First x87 opcode byte[2:0].
- Opcode Register Field[7:0] = Second x87 opcode byte[7:0].

For example, the x87 opcode D9 F8h is stored in the opcode register as 001\_1111\_1000b. The low-order three bits of the first opcode byte, D9h (1101\_1001b), are stored in opcode-register bits 10:8. The second opcode byte, F8h (1111\_1000b), is stored in bits 7:0 of the opcode register. The high-order five bits of the first opcode byte (1101\_1b) are not needed because they are identical for all x87 instructions.

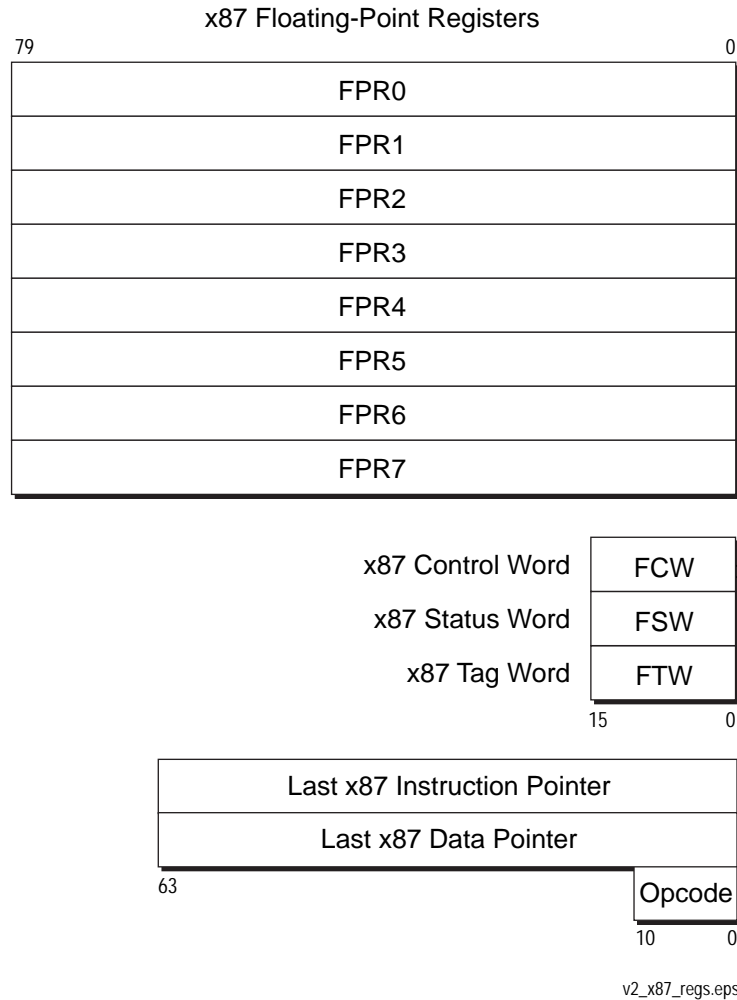

**Figure 11-3. x87 Execution Unit State**

### 11.4.4 Saving Media and x87 Execution Unit State

In most cases, operating systems, exception handlers, and device drivers should save and restore the media and/or x87 processor state between task switches or other interventions in the execution of 128-bit, 64-bit, or x87 procedures. Application programs are also free to save and restore state at any time.

In general, system software should use the FXSAVE and FXRSTOR instructions to save and restore the entire media and x87 processor state. The FSAVE/FNSAVE and FRSTOR instructions can be used for saving and restoring the x87 state. Because the 64-bit media registers are physically aliased onto the x87 registers, the FSAVE/FNSAVE and FRSTOR instructions can also be used to save and restore the 64-bit media state. However, FSAVE/FNSAVE and FRSTOR do not save or restore the 128-bit media state.

**FSAVE/FNSAVE and FRSTOR Instructions.** The FSAVE/FNSAVE and FRSTOR instructions save and restore the entire register state for 64-bit media instructions and x87 floating-point instructions. The FSAVE instruction stores the register state, but only after handling any pending unmasked-x87 floating-point exceptions. The FNSAVE instruction stores the register state but skips the reporting and handling of these exceptions. The state of all MMX/FPR registers is saved, as well as all other x87 state (the control word register, status word register, tag word, instruction pointer, data pointer, and last opcode). After saving this state, the tag state for all MMX/FPR registers is changed to *empty* and is thus available for a new procedure.

Starting on page 310, Figure 11-4 through Figure 11-7 show the memory formats used by the FSAVE/FNSAVE and FRSTOR instructions when storing the x87 state in various processor modes and using various effective-operand sizes. This state includes:

- *x87 Data Registers*
  - FPR0–FPR7 80-bit physical data registers.
- *x87 Environment*
  - FCW: x87 control word register
  - FSW: x87 status word register
  - FTW: x87 tag word
  - Last x87 instruction pointer
  - Last x87 data pointer
  - Last x87 opcode

The eight data registers are stored in the 80 bytes following the environment information. Instead of storing these registers in their physical order (FPR0–FPR7), the processor stores the registers in the their stack order, ST(0)–ST(7), beginning with the top-of-stack, ST(0).

		Bit Offset			Byte Offset
31		16	15	0	
ST(7)[79:48]					+68h
...					...
ST(1)[15:0]		ST(0)[79:64]			...
ST(0)[63:32]					...
ST(0)[31:0]					+1Ch
Reserved, IGN		Data DS Selector[15:0]			+18h
Data Offset[31:0]					+14h
00000b	Instruction Opcode[10:0]		Instruction CS Selector[15:0]		+10h
Instruction Offset[31:0]					+0Ch
Reserved, IGN		x87 Tag Word (FTW)			+08h
Reserved, IGN		x87 Status Word (FSW)			+04h
Reserved, IGN		x87 Control Word (FCW)			+00h

**Figure 11-4. FSAVE/FNSAVE Image (32-Bit, Protected Mode)**

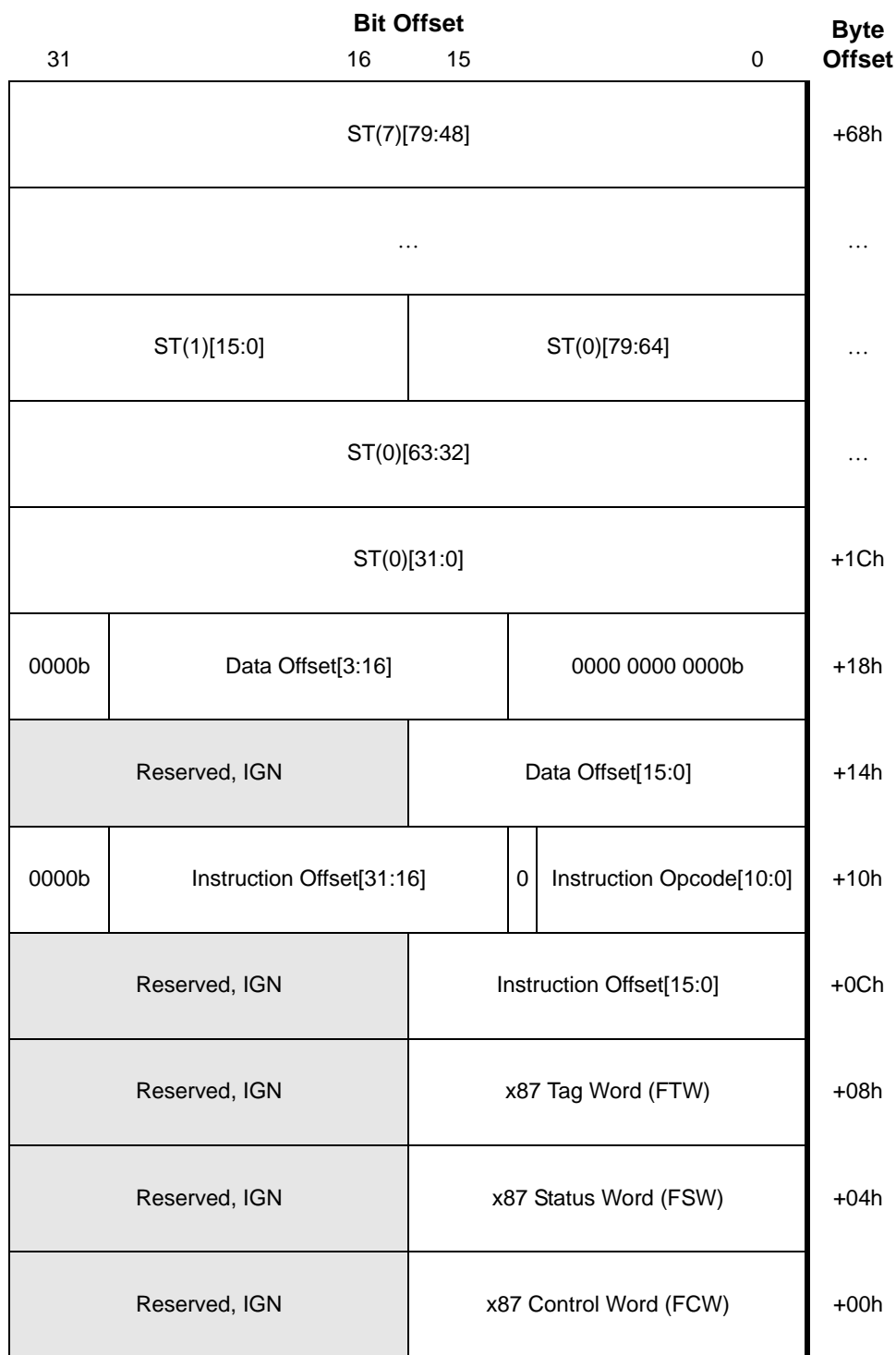

Figure 11-5. FSAVE/FNSAVE Image (32-Bit, Real/Virtual-8086 Modes)

Bit Offset		Byte Offset
31	16    15	0
<i>Not Part of x87 State</i>	ST(7)[79:64]	+5Ch
...		...
ST(0)[79:48]		+14h
ST(0)[47:16]		+10h
ST(0)[15:0]	Data DS Selector[15:0]	+0Ch
Data Offset[15:0]	Instruction CS Selector[15:0]	+08h
Instruction Offset[15:0]	x87 Tag Word (FTW)	+04h
x87 Status Word (FSW)	x87 Control Word (FCW)	+00h

**Figure 11-6. FSAVE/FNSAVE Image (16-Bit, Protected Mode)**



Bit Offset		Byte Offset		
31	16	15	0	
Not Part of x87 State		ST(7)[79:64]		+5Ch
...		...		...
ST(0)[79:48]				+14h
ST(0)[47:16]				+10h
ST(0)[15:0]	Data [19:16]	0000 0000 0000b		+0Ch
Data Offset [15:0]	Instruction [19:16]	0	Instruction Opcode[10:0]	+08h
Instruction Offset [15:0]	x87 Tag Word (FTW)			+04h
x87 Status Word (FSW)	x87 Control Word (FCW)			+00h

**Figure 11-7. FSAVE/FNSAVE Image (16-Bit, Real/Virtual-8086 Modes)**

**FLDENV/FNLDENV and FSTENV Instructions.** The FLDENV/FNLDENV and FSTENV instructions load and store only the x87 floating-point environment. These instructions, unlike the FSAVE/FNSAVE and FRSTOR instructions, do not save or restore the x87 data registers. The FLDENV/FSTENV instructions do not save the full 64-bit data and instruction pointers. 64-bit applications should use FXSAVE/FXRSTOR, rather than FLDENV/FSTENV. The format of the saved x87 environment images for protected mode and real/virtual mode are the same as those of the first 14-bytes of the FSAVE/FNSAVE images for 16-bit operands or 32/64-bit operands, respectively. See Figure 11-4 on page 310, Figure 11-5 on page 311, Figure 11-6 on page 312, and Figure 11-7.

**FXSAVE and FXRSTOR Instructions.** The FXSAVE and FXRSTOR instructions save and restore the entire 128-bit media, 64-bit media, and x87 state. These instructions usually execute faster than FSAVE/FNSAVE and FRSTOR because they do not normally save and restore the x87 exception pointers (last-instruction pointer, last data-operand pointer, and last opcode). The only case in which they do save the exception pointers is the relatively rare case in which the exception-summary bit in

the x87 status word (FSW.ES) is set to 1, indicating that an unmasked exception has occurred. The FXSAVE and FXRSTOR memory format contains fields for storing these values.

Unlike FSAVE and FNSAVE, the FXSAVE instruction does not alter the x87 tag word. Therefore, the contents of the shared 64-bit MMX and 80-bit FPR registers can remain valid after an FXSAVE instruction (or any other value the tag bits indicated before the save). Also, FXSAVE (like FNSAVE) does not check for pending unmasked-x87 floating-point exceptions.

Figure 11-9 on page 321 shows the memory format of the media x87 state in long mode. If a 32-bit operand size is used in 64-bit mode, the memory format is the same, except that RIP and RDS are stored as *sel:offset* pointers, as shown in Figure 11-10 on page 322.

For more information on the FXSAVE and FXRSTOR instructions, see individual instruction listings in "64-Bit Media Instruction Reference" of Volume 5.

## 11.5 XSAVE/XRSTOR Instructions

The XSAVE, XSAVEOPT, XRSTOR, XGETBV, and XSETBV instructions and associated data structures extend the FXSAVE/FXRSTOR memory image used to manage processor states and provide additional functionality. These instructions do not obviate the FXSAVE/FXRSTOR instructions. For more information about FXSAVE/FXRSTOR, see “*FXSAVE and FXRSTOR Instructions*” in *Volume 2*. For detailed descriptions of FXSAVE and FXRSTOR, see individual instruction listings in AMD64 Architecture Programmer’s Manual “*Volume 5: 64-Bit Media and x87 Floating-Point Instructions.*”

The CPUID instruction is used to identify features supported in processor hardware. Extended control registers are used to enable and disable the handling of processor states associated with supported hardware features and to communicate to an application whether an operating system supports a particular feature that has a processor state specific to it.

### 11.5.1 CPUID Enhancements

- CPUID Fn0000\_00001\_ECX[XSAVE] indicates that the processor supports XSAVE/XRSTOR instructions and at least one XCR.
- CPUID Fn0000\_00001\_ECX[OSXSAVE] indicates whether the operating system has enabled extensible state management and supports processor extended state management.
- CPUID Fn0000\_0000D enumerates processor states (including legacy x87 FPU states, SSE states, and processor extended states), the offset, and the size of the save area for each processor extended state. Sub-functions (ECX > 0) provide details concerning features and support of processor states enumerated in the root function.

### 11.5.2 XFEATURE\_ENABLED\_MASK

XFEATURE\_ENABLED\_MASK is set up by privileged software to enable the saving and restoring of extended processor architectural state information supported by a specific processor. Clearing defined bit fields in this mask inhibits the XSAVE instruction from saving (and XRSTOR from restoring) this state information.

XFEATURE\_ENABLED\_MASK is addressed as XCR0 in the extended control register space and is accessed via the XSETBV and XGETBV instructions.

XFEATURE\_ENABLED\_MASK is defined as follows:

63	62	61					3	2	1	0
X	LWP	Reserved						YMM	SSE	x87

Bits	Mnemonic	Description
63	X	Reserved specifically for XCR0 bit vector expansion. Reserved, MBZ.
62	LWP	When set, Lightweight Profiling (LWP) extensions are enabled and XSAVE/XRSTOR supports LWP state management.
61:3	—	Reserved, MBZ
2	YMM	When set, 256-bit SSE state management is supported by XSAVE/XRSTOR. Must be set to enable AVX extensions.
1	SSE	When set, 128-bit SSE state management is supported by XSAVE/XRSTOR. This bit must be set if YMM is set. Must be set to enable AVX extensions.
0	x87	x87 FPU state management is supported by XSAVE/XRSTOR. Must be set to 1.

**Figure 11-8. XFEATURE\_ENABLED\_MASK Register (XCR0)**

Hardware initializes XCR0 to 0000\_0000\_0000\_0001h. On writing this register, software must insure that XCR0[63:3] is clear, XCR0[0] is set, and that XCR0[2:1] is not equal to 10b. An attempt to write data that violates these rules results in a #GP.

### 11.5.3 Extended Save Area

The XSAVE/XRSTOR save area extends the legacy 512-byte FXSAVE/FXRSTOR memory image to provide a compatible register state management environment as well as an upward migration path. The save area is architecturally defined to be extendable and enumerated by the sub-functions of CPUID Fn 0000\_000Dh. Figure 11-2 shows the format of the XSAVE/XRSTOR area.

**Table 11-2. Extended Save Area Format**

Save Area	Offset (Byte)	Size (Bytes)
FPU/SSE Save Area	0	512
Header	512	64
Reserved, (Ext_Save_Area_2)	CPUID Fn 0000_000D_EBX_x02	CPUID Fn 0000_000D_EAX_x02
Reserved, (Ext_Save_Area_3)	CPUID Fn 0000_000D_EBX_x03	CPUID Fn 0000_000D_EAX_x03
Reserved, (Ext_Save_Area_4)	CPUID Fn 0000_000D_EBX_x04	CPUID Fn 0000_000D_EAX_x04
Reserved, (...)	...	...
<b>Note:</b> Bytes 464–511 are available for software use. XRSTOR ignores bytes 464–511 of an XSAVE image.		

The register fields of the first 512 bytes of the XSAVE/XRSTOR area are the same as those of the FXSAVE/FXRSTOR area, but the 512-byte area is organized as x87 FPU states, MXCSR (including MXCSR\_MASK), and XMM registers. The layout of the save area is fixed and may contain non-contiguous individual save areas because a processor does not support certain extended states or because system software does not support certain processor extended states. The save area is not compacted when features are not saved or are not supported by the processor or by system software.

For more information on using the CPUID instruction to obtain processor implementation information, see Section 3.3, “Processor Feature Identification,” on page 63.

### 11.5.4 Instruction Functions

CR4.OSXSAVE and XCR0 can be read at all privilege levels but written only at ring 0.

- XGETBV reads XCR0.
- XSETBV writes XCR0, ring 0 only.
- XRSTOR restores states specified by bitwise AND of a mask operand in EDX:EAX with XCR0.
- XSAVE (and XSAVEOPT) saves states specified by bitwise AND of a mask operand in EDX:EAX with XCR0.

### 11.5.5 YMM States and Supported Operating Modes

Extended instructions operate on YMM states by means of extended (XOP/VEX) prefix encoding. When a processor supports YMM states, the states exist in all operating modes, but interfaces to access the YMM states may vary by mode. Processor support for extended prefix encoding is independent of processor support of YMM states.

Instructions that use extended prefix encoding are generally supported in long and protected modes, but are not supported in real or virtual 8086 modes, or when entering SMM mode. Bits 255:128 of the YMM register state are maintained across transitions into and out of these modes. The XSAVE/XRSTOR instructions function in all operating modes; XRSTOR can modify YMM register state in any operating mode, using state information from the XSAVE/XRSTOR area.

### 11.5.6 Extended SSE Execution State Management

Operating system software must use the XSAVE/XRSTOR instructions for extended SSE execution state management. XSAVEOPT, a performance optimized version of XSAVE, may be used instead of XSAVE once the XSAVE/XRSTOR save area is initialized. In the following discussion XSAVEOPT may be substituted for the instruction XSAVE. The instructions also provide an interface to manage XMM/MXCSR states and x87 FPU states in conjunction with processor extended states. An operating system must enable extended SSE execution state management prior to the execution of extended SSE instructions. Attempting to execute an extended SSE instruction without enabling execution state management causes a #UD exception.

#### 11.5.6.1 Enabling Extended SSE Instruction Execution

To enable extended SSE instruction execution and state management, system software must carry out the following process:

- Confirm that the hardware supports the XSAVE, XRSTOR, XSETBV, and XGETBV instructions and the XCR0 register (XFEATURE\_ENABLED\_MASK) by executing the CPUID instruction function 0000\_0001h. If CPUID Fn0000\_0001\_ECX[XSAVE] is set, hardware support is verified.

- Optionally confirm hardware support of the XSAVEOPT instruction by executing CUID function 0000\_000Dh, sub-function 1 (ECX = 1). If CUID Fn0000\_000D\_EAX\_x1[XSAVEOPT] is set, the processor supports the XSAVEOPT instruction. XSAVEOPT is a performance optimized version of XSAVE. (SDCR-3580)
- Confirm that hardware supports the extended SSE instructions by verifying XFeatureSupportedMask[2:0] = 111b. XFeatureSupportedMask is accessed via the CUID instruction function 0000\_000Dh, sub-function 0 (ECX = 0).  
If CUID Fn0000\_000D\_EAX\_x0[2:0] = 111b, hardware supports x87, legacy SSE, and extended SSE instructions. Bit 0 of EAX signifies x87 floating-point and MMX support, bit 1 signifies legacy SSE support, and bit 2 signifies extended SSE support. Support for both x87 and legacy SSE instructions are required for processors that support the extended SSE instructions.
- Set CR4[OSXSAVE] (bit 18) to enable the use of the XSETBV and XGETBV instructions. XSETBV is a privileged instruction that writes the XCRn registers. XCR0 is the XFEATURE\_ENABLED\_MASK used to manage media and x87 processor state using the XSAVE, XSAVEOPT, and XRSTOR instructions.
- Enable the x87/MMX, legacy SSE, and extended SSE instructions and processor state management by setting the x87, SSE, and YMM bits of XCR0 (XFEATURE\_ENABLED\_MASK). Enabling extended SSE capabilities without enabling legacy SSE capabilities is not allowed. The x87 flag (bit 0) of the XFEATURE\_ENABLED\_MASK must be set when writing XCR0.
- Determine the XSAVE/XRSTOR memory save area size requirement. The field XFeatureEnabledSizeMax specifies the size requirement in bytes based on the currently enabled extended features and is returned in the EAX register after execution of CUID Function 0000\_000Dh, sub-function 0 (ECX = 0).
- Allocate the save/restore area based on the information obtained in the previous step.

For more information on the XSETBV and XGETBV instructions, see individual instruction descriptions in Volume 4. XFEATURE\_ENABLED\_MASK fields are defined in Section 11.5.2 above.

For more information on using the CUID instruction to obtain processor implementation information, see Section 3.3, “Processor Feature Identification,” on page 63.

### 11.5.7 Saving Processor State

The XSTATE header starts at byte offset 512 in the save area. XSTATE\_BV is the first 64-bit field in the header. The order of bit vectors in XSTATE\_BV matches the order of bit vectors in XCR0. The XSAVE instruction sets bits in the XSTATE\_BV vector field when it writes the corresponding processor extended state to a save area in memory. XSAVE modifies only bits for processor states specified by bitwise AND of the XSAVE bit mask operand in EDX:EAX with XCR0. If software modifies the save area image of a particular processor state component directly, it must also set the corresponding bit of XSTATE\_BV. If the bit is not set, directly modified state information in a save area image may be ignored by XRSTOR.

XSAVEOPT, a performance optimized version of the XSAVE instruction, may be used (if supported) in lieu of the XSAVE instruction once the XSAVE/XRSTOR save area has been initialized via the execution of the XSAVE instruction.

### 11.5.8 Restoring Processor State

When XRSTOR is executed, processor state components are updated only if the corresponding bits in the mask operand (EDX:EAX) and XCR0 are both set. For each updated component, when the corresponding bit in the XSTATE\_BV field in the save area header is set, the component is loaded from the save area in memory. When the XSTATE\_BV bit is cleared, the state is set to the hardware-specified initial values shown in Table 11-3.

**Table 11-3. XRSTOR Hardware-Specified Initial Values**

Component	Initial Value
x87	FCW = 037Fh FSW = 0000h Empty/Full = 00h (FTW = FFFFh) x87 Error Pointers = 0 ST0 - ST7 = 0
XMM	XMM0 - XMM15 = 0, if 64-bit mode XMM0 - XMM7 = 0, if !64-bit mode
YMM_HI	YMM_HI0 - YMM_HI15 = 0, if 64-bit mode YMM_HI0 - YMM_HI7 = 0, if !64-bit mode
LWP	LWP disabled

### 11.5.9 MXCSR State Management

The MXCSR has no hardware-specified initial state; it is read from the save area in memory whenever either XMM or YMM\_HI are updated.

### 11.5.10 Mode-Specific XSAVE/XRSTOR State Management

Some state is conditionally saved or updated, depending on processor state:

- The x87 error pointers are not saved or restored if the state saved or loaded from memory doesn't have a pending #MF.
- XMM8–XMM15 are not saved or restored in non 64-bit mode.
- YMM\_HI8–YMM\_HI15 are not saved or restored in non 64-bit mode.



F	E	D	C	B	A	9	8	7	6	5	4	3	2	1	0	Byte
Reserved, IGN																+1F0h
...																...
Reserved, IGN																+1A0h
XMM15																+190h
XMM14																+180h
XMM13																+170h
XMM12																+160h
XMM11																+150h
XMM10																+140h
XMM9																+130h
XMM8																+120h
XMM7																+110h
XMM6																+100h
XMM5																+F0h
XMM4																+E0h
XMM3																+D0h
XMM2																+C0h
XMM1																+B0h
XMM0																+A0h
Reserved, IGN						ST(7)										+90h
Reserved, IGN						ST(6)										+80h
Reserved, IGN						ST(5)										+70h
Reserved, IGN						ST(4)										+60h
Reserved, IGN						ST(3)										+50h
Reserved, IGN						ST(2)										+40h
Reserved, IGN						ST(1)										+30h
Reserved, IGN						ST(0)										+20h
MXCSR_MASK				MXCSR				RDP <sup>1</sup>								+10h
RIP <sup>1</sup>								FOP	0	FTW	FSW	FCW	+00h			

1. Stored as sel:offset if operand size is 32 bits. 32bit sel:offset format of the pointers is shown in figure 11-10.

**Figure 11-9. FXSAVE and FXRSTOR Image (64-bit Mode)**

F	E	D	C	B	A	9	8	7	6	5	4	3	2	1	0	Byte
Reserved, IGN																+1F0h
...																...
Reserved, IGN																+120h
XMM7																+110h
XMM6																+100h
XMM5																+F0h
XMM4																+E0h
XMM3																+D0h
XMM2																+C0h
XMM1																+B0h
XMM0																+A0h
Reserved, IGN						ST(7)										+90h
Reserved, IGN						ST(6)										+80h
Reserved, IGN						ST(5)										+70h
Reserved, IGN						ST(4)										+60h
Reserved, IGN						ST(3)										+50h
Reserved, IGN						ST(2)										+40h
Reserved, IGN						ST(1)										+30h
Reserved, IGN						ST(0)										+20h
MXCSR_MASK				MXCSR				rsrvd, IGN		DS		DP				+10h
rsrvd, IGN		CS		EIP				FOP		0	FTW	FSW		FCW		+00h

**Figure 11-10. FXSAVE and FXRSTOR Image (Non-64-bit Mode)**

Software can read and write all fields within the FXSAVE and FXRSTOR memory image. These fields include:

- *FCW*—Bytes 01h–00h. x87 control word.
- *FSW*—Bytes 03h–02h. x87 status word.
- *FTW*—Byte 04h. x87 tag word. See “FXSAVE Format for x87 Tag Word” on page 323 for additional information on the FTW format saved by the FXSAVE instruction.
- (Byte 05h contains the value 00h.)
- *FOP*—Bytes 07h–06h. last x87 opcode.
- *Last x87 Instruction Pointer*—A pointer to the last non-control x87 floating-point instruction executed by the processor:

- *RIP (64-bit format)*—Bytes 0Fh–08h. 64-bit offset into the code segment (used without a CS selector).
- *EIP (32-bit format)*—Bytes 0Bh–08h. 32-bit offset into the code segment.
- *CS (32-bit format)*—Bytes 0Dh–0Ch. Segment selector portion of the pointer.
- *Last x87 Data Pointer*—If the last non-control x87 floating point instruction referenced memory, this value is a pointer to the data operand referenced by the last non-control x87 floating-point instruction executed by the processor:
  - *RDP (64-bit format)*—Bytes 17h–10h. 64-bit offset into the data segment (used without a DS selector).
  - *DP (32-bit format)*—Bytes 13h–10h. 32-bit offset into the data segment.
  - *DS (32-bit format)*—Bytes 15h–14h. Segment selector portion of the pointer.

If the last non-control x87 instruction did not reference memory, then the value in the pointer is implementation dependent.

- *MXCSR*—Bytes 1Bh–18h. 128-bit media-instruction control and status register. This register is saved only if CR4.OSFXSR is set to 1.
- *MXCSR\_MASK*—Bytes 1Fh–1Ch. Set bits in *MXCSR\_MASK* indicate supported feature bits in *MXCSR*. For example, if bit 6 (the DAZ bit) in the returned *MXCSR\_MASK* field is set to 1, the DAZ mode and the DAZ flag in *MXCSR* are supported. Cleared bits in *MXCSR\_MASK* indicate reserved bits in *MXCSR*. If software attempts to set a reserved bit in the *MXCSR* register, a #GP exception will occur. To avoid this exception, after software clears the FXSAVE memory image and executes the FXSAVE instruction, software should use the value returned by the processor in the *MXCSR\_MASK* field when writing a value to the *MXCSR* register, as follows:
  - *MXCSR\_MASK = 0*: If the processor writes a zero value into the *MXCSR\_MASK* field, the denormals-are-zeros (DAZ) mode and the DAZ flag in *MXCSR* are *not* supported. Software should use the default mask value, 0000\_FFBFh (bit 6, the DAZ bit, and bits 31:16 cleared to 0), to mask any value it writes to the *MXCSR* register to ensure that all reserved bits in *MXCSR* are written with 0, thus avoiding a #GP exception.
  - *MXCSR\_MASK ... 0*: If the processor writes a non-zero value into the *MXCSR\_MASK* field, software should AND this value with any value it writes to the *MXCSR* register.
- *MMXn/FPRn*—Bytes 9Fh–20h. Shared 64-bit media and x87 floating-point registers. As in the case of the x87 FSAVE instruction, these registers are stored in stack order ST(0)–ST(7). The upper six bytes in the memory image for each register are reserved.
- *XMMn*—Bytes 11Fh–A0h. 128-bit media registers. These registers are saved only if CR4.OSFXSR is set to 1.

**FXSAVE Format for x87 Tag Word.** Rather than saving the entire x87 tag word, FXSAVE saves a single-byte encoded version. FXSAVE encodes each of the eight two-bit fields in the x87 tag word as follows:

- Two-bit values of 00, 01, and 10 are encoded as a 1, indicating the corresponding x87 *FPRn* register holds a value.

- A two-bit value of 11 is encoded as a 0, indicating the corresponding x87 FPR $n$  is empty.

For example, assume an FSAVE instruction saves an x87 tag word with the value 83F1h. This tag-word value describes the x87 FPR $n$  contents as follows:

x87 Register	FPR7	FPR6	FPR5	FPR4	FPR3	FPR2	FPR1	FPR0
Tag Word Value (hex)	8		3		F		1	
Tag Value (binary)	10	00	00	11	11	11	00	01
Meaning	Special	Valid	Valid	Empty	Empty	Empty	Valid	Zero

When an FXSAVE is used to write the x87 tag word to memory, it encodes the value as E3h. This encoded version describes the x87 FPR $n$  contents as follows:

x87 Register	FPR7	FPR6	FPR5	FPR4	FPR3	FPR2	FPR1	FPR0
Encoded Tag Byte (hex)	E				3			
Tag Value (binary)	1	1	1	0	0	0	1	1
Meaning	Valid	Valid	Valid	Empty	Empty	Empty	Valid	Valid

If necessary, software can decode the single-bit FXSAVE tag-word fields into the two-bit field FSAVE uses by examining the contents of the corresponding FPR registers saved by FXSAVE. Table 11-4 on page 325 shows how the FPR contents are used to find the equivalent FSAVE tag-field value. The *fraction* column refers to fraction portion of the extended-precision significand (bits 62:0). The *integer bit* column refers to the integer-portion of the significand (bit 63). See Chapter 11, “SSE, MMX, and x87 Programming,” on page 301 for more information on floating-point numbering formats.

Table 11-4. Deriving FSAVE Tag Field from FXSAVE Tag Field

Encoded FXSAVE Tag Field	Exponent	Integer Bit <sup>2</sup>	Fraction <sup>1</sup>	Type of Value	Equivalent FSAVE Tag Field	
1 (Valid)	All 0s	0	All 0s	Zero	01 (Zero)	
		0	Not all 0s	Denormal	10 (Special)	
		1	All 0s	Pseudo Denormal		
		1	Not all 0s			
	Neither all 0s nor all 1s	0	don't care	Unnormal	00 (Valid)	
		1		Normal		
	All 1s	0		Pseudo Infinity or Pseudo NaN	10 (Special)	
		1		All 0s		Infinity
				Not all 0s		NaN
	0 (Empty)	don't care			Empty	11 (Empty)

**Note:**

- Bits 62:0 of the significand. Bit 62, the most-significant bit of the fraction, is also called the *M* bit.
- Bit 63 of the significand, also called the *J* bit.

**Performance Considerations.** When system software supports multi-tasking, it must be able to save the processor state for one task and load the state for another. For performance reasons, the media and/or x87 processor state is usually saved and loaded only when necessary. System software can save and load this state at the time a task switch occurs. However, if the new task does not use the state, loading the state is unnecessary and reduces performance.

The task-switch bit (CR0.TS) is provided as a *lazy* context-switch mechanism that allows system software to save and load the processor state only when necessary. When CR0.TS=1, a device-not-available exception (#NM) occurs when an attempt is made to execute a 128-bit media, 64-bit media, or x87 instruction. System software can use the #NM exception handler to save the state of the previous task, and restore the state of the current task. Before returning from the exception handler to the media or x87 instruction, system software must clear CR0.TS to 0 to allow the instruction to be executed. Using this approach, the processor state is saved only when the registers are used.

In legacy mode, the hardware task-switch mechanism sets CR0.TS=1 during a task switch (see “Task Switched (TS) Bit” on page 44 for more information). In long mode, the hardware task-switching is not supported, and the CR0.TS bit is not set by the processor. Instead, the architecture assumes that system software handles all task-switching and state-saving functions. If CR0.TS is to be used in long mode for controlling the save and restore of media or x87 state, system software must set and clear it explicitly.



## 12 Task Management

---

This chapter describes the hardware task-management features. All of the legacy x86 task-management features are supported by the AMD64 architecture in legacy mode, but most features are not available in long mode. Long mode, however, requires system software to initialize and maintain certain task-management *resources*. The details of these resource-initialization requirements for long mode are discussed in “Task-Management Resources” on page 328.

### 12.1 Hardware Multitasking Overview

A task (also called a *process*) is a program that the processor can execute, suspend, and later resume executing at the point of suspension. During the time a task is suspended, other tasks are allowed to execute. Each task has its own execution space, consisting of:

- Code segment and instruction pointer.
- Data segments.
- Stack segments for each privilege level.
- General-purpose registers.
- rFLAGS register.
- Local-descriptor table.
- Task register, and a link to the previously-executed task.
- I/O-permission and interrupt-permission bitmaps.
- Pointer to the page-translation tables (CR3).

The state information defining this execution space is stored in the task-state segment (TSS) maintained for each task.

Support for hardware multitasking is provided in legacy mode. Hardware multitasking provides automated mechanisms for switching tasks, saving the execution state of the suspended task, and restoring the execution state of the resumed task. When hardware multitasking is used to switch tasks, the processor takes the following actions:

- Suspends execution of the task, allowing any executing instructions to complete and save their results.
- Saves the task execution state in the task TSS.
- Loads the execution state for the new task from its TSS.
- Begins executing the new task at the location specified in the new task TSS.

Software can switch tasks by branching to a new task using the CALL or JMP instructions. Exceptions and interrupts can also switch tasks if the exception or interrupt handlers are themselves separate tasks. IRET can be used to return to an earlier task.

## 12.2 Task-Management Resources

The hardware-multitasking features are available when protected mode is enabled (CR0.PE=1). Protected-mode software execution, by definition, occurs as part of a task. While system software is not required to use the hardware-multitasking features, it is required to initialize certain task-management resources for at least one task (the current task) when running in protected mode. This single task is needed to establish the protected-mode execution environment. The resources that must be initialized are:

- *Task-State Segment (TSS)*—A segment that holds the processor state associated with a task.
- *TSS Descriptor*—A segment descriptor that defines the task-state segment.
- *TSS Selector*—A segment selector that references the TSS descriptor located in the GDT.
- *Task Register*—A register that holds the TSS selector and TSS descriptor for the current task.

Figure 12-1 on page 329 shows the relationship of these resources to each other in both 64-bit and 32-bit operating environments.



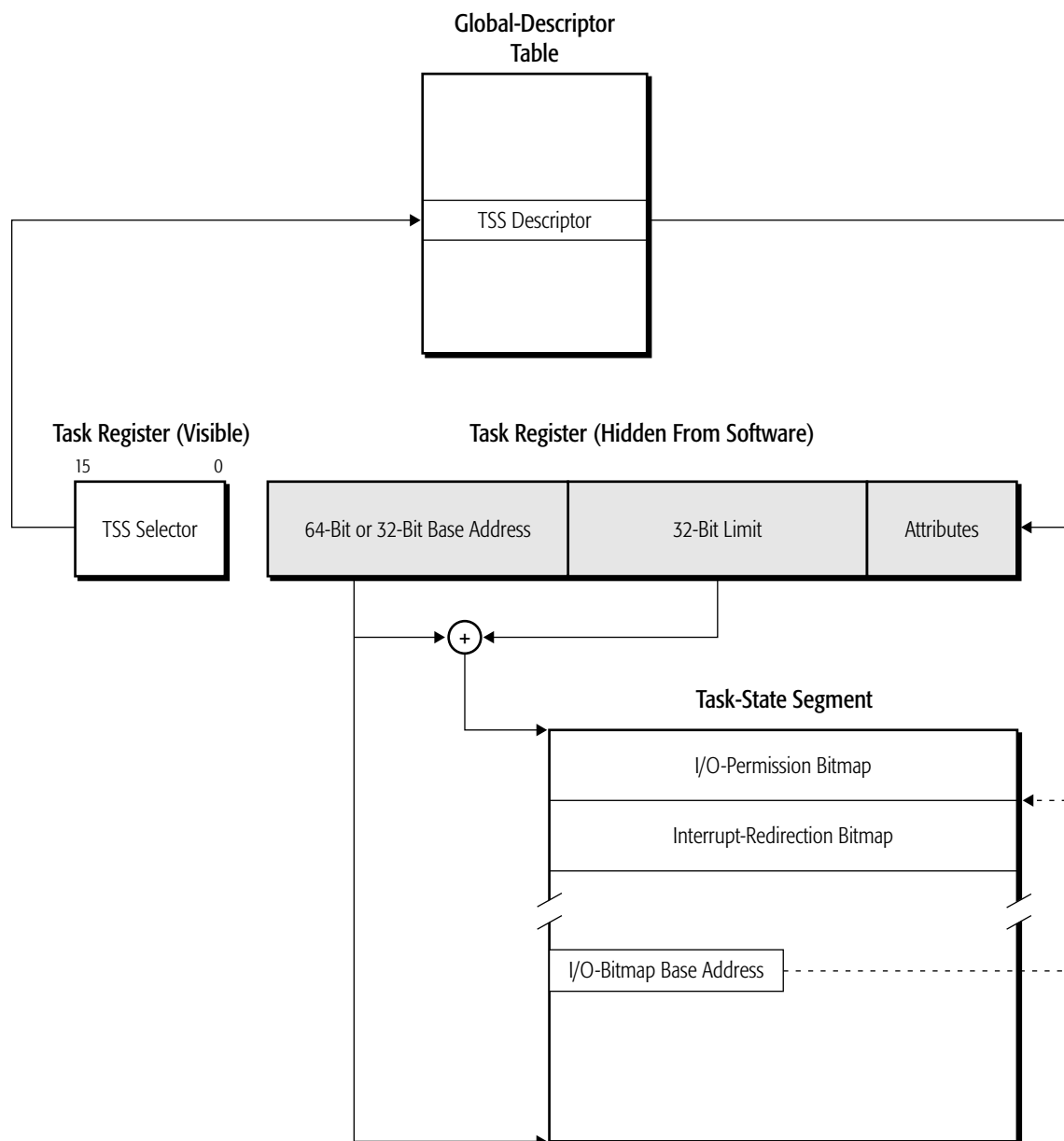

**Figure 12-1. Task-Management Resources**

A fifth resource is available in legacy mode for use by system software that uses the hardware-multitasking mechanism to manage more than one task:

- *Task-Gate Descriptor*—This form of gate descriptor holds a reference to a TSS descriptor and is used to control access between tasks.

The task-management resources are described in the following sections.

### 12.2.1 TSS Selector

TSS selectors are selectors that point to task-state segment descriptors in the GDT. Their format is identical to all other segment selectors, as shown in Figure 12-2.

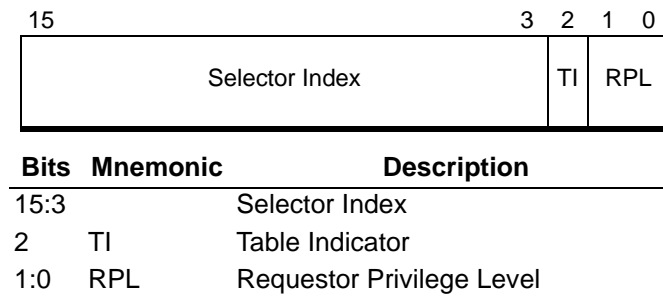

**Figure 12-2. Task-Segment Selector**

The selector format consists of the following fields:

**Selector Index.** Bits 15:3. The selector-index field locates the TSS descriptor in the global-descriptor table.

**Table Indicator (TI) Bit.** Bit 2. The TI bit must be cleared to 0, which indicates that the GDT is used. TSS descriptors cannot be located in the LDT. If a reference is made to a TSS descriptor in the LDT, a general-protection exception (#GP) occurs.

**Requestor Privilege-Level (RPL) Field.** Bits 1:0. RPL represents the privilege level (CPL) the processor is operating under at the time the TSS selector is loaded into the task register.

### 12.2.2 TSS Descriptor

The TSS descriptor is a system-segment descriptor, and it can be located only in the GDT. The format for an 8-byte, legacy-mode and compatibility-mode TSS descriptor can be found in “System Descriptors” on page 85. The format for a 16-byte, 64-bit mode TSS descriptor can be found in “System Descriptors” on page 90.

The fields within a TSS descriptor (all modes) are described in “Descriptor Format” on page 80. The following additional information applies to TSS descriptors:

- *Segment Limit*—A TSS descriptor must have a segment limit value of at least 67h, which defines a minimum TSS size of 68h (104 decimal) bytes. If the limit is less than 67h, an invalid-TSS exception (#TS) occurs during the task switch. When an I/O-permission bitmap, interrupt-redirectation bitmap, or additional state information is included in the TSS, the limit must be set to a value large enough to enclose that information. In this case, if the TSS limit is not large enough to

hold the additional information, a #GP exception occurs when an attempt is made to access beyond the TSS limit. No check for the larger limit is performed during the task switch.

- *Type*—Four system-descriptor types are defined as TSS types, as shown in Table 4-5 on page 85. Bit 9 is used as the descriptor busy bit (B). This bit indicates that the task is busy when set to 1, and available when cleared to 0. Busy tasks are the currently running task and any previous (outer) tasks in a nested-task hierarchy. Task recursion is not supported, and a #GP exception occurs if an attempt is made to transfer control to a busy task. See “Nesting Tasks” on page 345 for additional information.

In long mode, the 32-bit TSS types (available and busy) are redefined as 64-bit TSS types, and only 64-bit TSS descriptors can be used. Loading the task register with an available 64-bit TSS causes the processor to change the TSS descriptor type to indicate a busy 64-bit TSS. Because long mode does not support task switching, the TSS-descriptor busy bit is never cleared by the processor to indicate an available 64-bit TSS.

Sixteen-bit TSS types are illegal in long mode. A general-protection exception (#GP) occurs if a reference is made to a 16-bit TSS.

### 12.2.3 Task Register

The *task register* (TR) points to the TSS location in memory, defines its size, and specifies its attributes. As with the other descriptor-table registers, the TR has two portions. A *visible* portion holds the TSS selector, and a *hidden* portion holds the TSS descriptor. When the TSS selector is loaded into the TR, the processor automatically loads the TSS descriptor from the GDT into the hidden portion of the TR.

The TR is loaded with a new selector using the LTR instruction. The TR is also loaded during a task switch, as described in “Switching Tasks” on page 341.

Figure 12-3 shows the format of the TR in legacy mode.

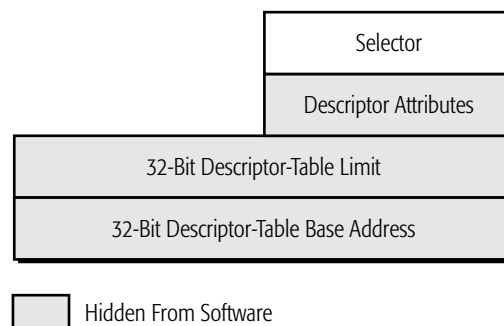

**Figure 12-3. TR Format, Legacy Mode**

Figure 12-4 shows the format of the TR in long mode (both compatibility mode and 64-bit mode).

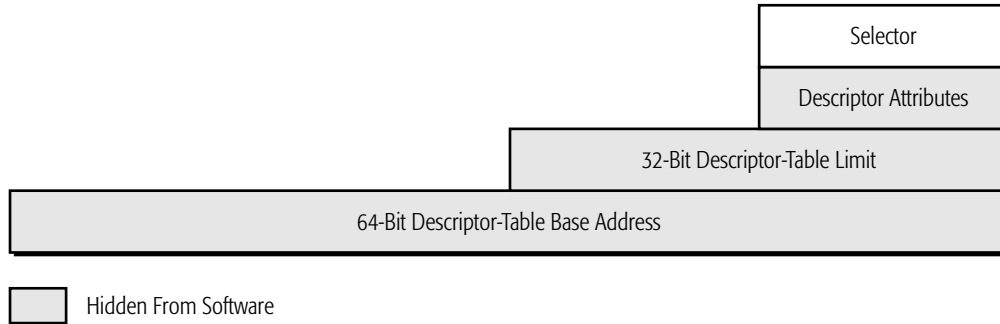

**Figure 12-4. TR Format, Long Mode**

The AMD64 architecture expands the TSS-descriptor base-address field to 64 bits so that system software running in long mode can access a TSS located anywhere in the 64-bit virtual-address space. The processor ignores the 32 high-order base-address bits when running in legacy mode. Because the TR is loaded from the GDT, the system-segment descriptor format has been expanded to 16 bytes by the AMD64 architecture in support of 64-bit mode. See “System Descriptors” on page 90 for more information on this expanded format. The high-order base-address bits are only loaded from 64-bit mode using the LTR instruction. Figure 12-5 shows the relationship between the TSS and GDT.

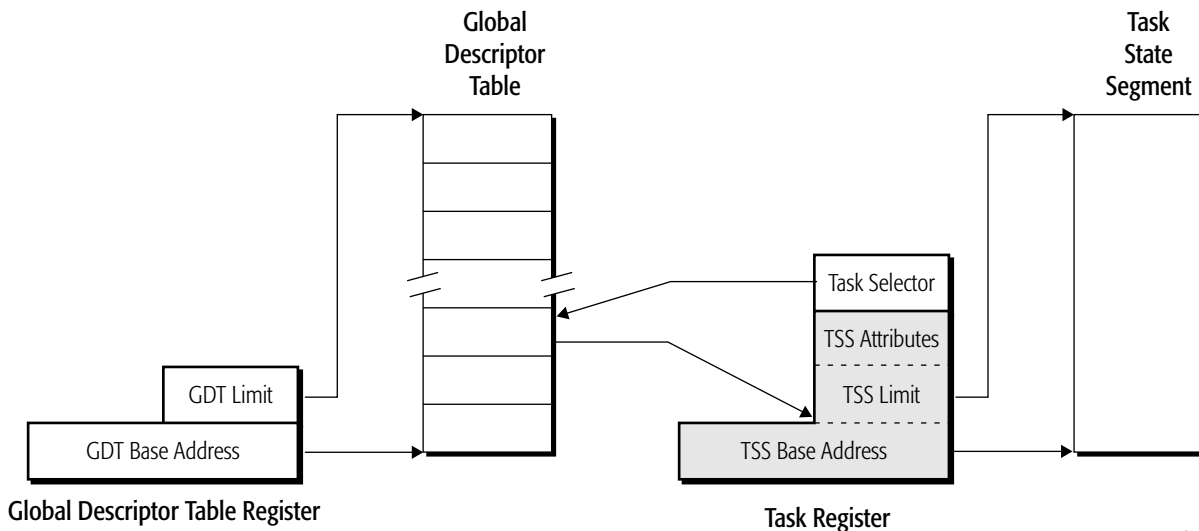

**Figure 12-5. Relationship between the TSS and GDT**

Long mode requires the use of a 64-bit TSS type, and this type must be loaded into the TR by executing the LTR instruction in *64-bit mode*. Executing the LTR instruction in 64-bit mode loads the TR with the full 64-bit TSS base address from the 16-byte TSS descriptor format (compatibility mode can only load 8-byte system descriptors). A processor running in either compatibility mode or 64-bit mode uses the full 64-bit TR.base address.

#### 12.2.4 Legacy Task-State Segment

The task-state segment (TSS) is a data structure in memory that the processor uses to save and restore the execution state for a task when a task switch occurs. Figure 12-6 on page 334 shows the format of a legacy 32-bit TSS.

Bit Offset		Byte Offset
31	16 15	0
I/O-Permission Bitmap (IOPB) (Up to 8 Kbytes)		IOPB Base
Interrupt-Redirection Bitmap (IRB) (Eight 32-Bit Locations)		
↑ Operating-System Data Structure ↓		
I/O-Permission Bitmap Base Address	Reserved, IGN	T +64h
Reserved, IGN	LDT Selector	+60h
Reserved, IGN	GS	+5Ch
Reserved, IGN	FS	+58h
Reserved, IGN	DS	+54h
Reserved, IGN	SS	+50h
Reserved, IGN	CS	+4Ch
Reserved, IGN	ES	+48h
EDI		+44h
ESI		+40h
EBP		+3Ch
ESP		+38h
EBX		+34h
EDX		+30h
ECX		+2Ch
EAX		+28h
EFLAGS		+24h
EIP		+20h
CR3		+1Ch
Reserved, IGN	SS2	+18h
ESP2		+14h
Reserved, IGN	SS1	+10h
ESP1		+0Ch
Reserved, IGN	SS0	+08h
ESP0		+04h
Reserved, IGN	Link (Prior TSS Selector)	+00h

Figure 12-6. Legacy 32-bit TSS

The 32-bit TSS contains three types of fields:

- *Static fields* are read by the processor during a task switch when a new task is loaded, but are not written by the processor when a task is suspended.
- *Dynamic fields* are read by the processor during a task switch when a new task is loaded, and are written by the processor when a task is suspended.
- *Software-defined fields* are read and written by software, but are not read or written by the processor. All but the first 104 bytes of a TSS can be defined for software purposes, minus any additional space required for the optional I/O-permission bitmap and interrupt-redirection bitmap.

TSS fields are not read or written by the processor when the LTR instruction is executed. The LTR instruction loads the TSS descriptor into the TR and marks the task as busy, but it does not cause a task switch.

The TSS fields used by the processor in legacy mode are:

- *Link*—Bytes 01h–00h, dynamic field. Contains a copy of the task selector from the previously-executed task. See “Nesting Tasks” on page 345 for additional information.
- *Stack Pointers*—Bytes 1Bh–04h, static field. Contains the privilege 0, 1, and 2 stack pointers for the task. These consist of the stack-segment selector ( $SS_n$ ), and the stack-segment offset ( $ESP_n$ ).
- *CR3*—Bytes 1Fh–1Ch, static field. Contains the page-translation-table base-address (CR3) register for the task.
- *EIP*—Bytes 23h–20h, dynamic field. Contains the instruction pointer (EIP) for the next instruction to be executed when the task is restored.
- *EFLAGS*—Bytes 27h–24h, dynamic field. Contains a copy of the EFLAGS image at the point the task is suspended.
- *General-Purpose Registers*—Bytes 47h–28h, dynamic field. Contains a copy of the EAX, ECX, EDX, EBX, ESP, EBP, ESI, and EDI values at the point the task is suspended.
- *Segment-Selector Registers*—Bytes 59h–48h, dynamic field. Contains a copy of the ES, CS, SS, DS, FS, and GS, values at the point the task is suspended.
- *LDT Segment-Selector Register*—Bytes 63h–60h, static field. Contains the local-descriptor-table segment selector for the task.
- *T (Trap) Bit*—Bit 0 of byte 64h, static field. This bit, when set to 1, causes a debug exception (#DB) to occur on a task switch. See “Breakpoint Instruction (INT3)” on page 360 for additional information.
- *I/O-Permission Bitmap Base Address*—Bytes 67h–66h, static field. This field represents a 16-bit offset into the TSS. This offset points to the beginning of the I/O-permission bitmap, and the end of the interrupt-redirection bitmap.
- *I/O-Permission Bitmap*—Static field. This field specifies protection for I/O-port addresses (up to the 64K ports supported by the processor), as follows:
  - Whether the port can be accessed at any privilege level.
  - Whether the port can be accessed outside the privilege level established by EFLAGS.IOPL.

- Whether the port can be accessed when the processor is running in virtual-8086 mode.

Because one bit is used per 8-byte I/O-port, this bitmap can take up to 8 Kbytes of TSS space. The bitmap can be located anywhere within the first 64 Kbytes of the TSS, as long as it is above byte 103. The last byte of the bitmap must contain all ones (0FFh). See “I/O-Permission Bitmap” on page 336 for more information.

- *Interrupt-Redirection Bitmap*—Static field. This field defines how each of the 256-possible software interrupts is directed in a virtual-8086 environment. One bit is used for each interrupt, for a total bitmap size of 32 bytes. The bitmap can be located anywhere above byte 103 within the first 64 Kbytes of the TSS. See “Interrupt Redirection of Software Interrupts” on page 256 for information on using this field.

The TSS can be paged by system software. System software that uses the hardware task-switch mechanism must guarantee that a page fault does not occur during a task switch. Because the processor only reads and writes the first 104 TSS bytes during a task switch, this restriction only applies to those bytes. The simplest approach is to align the TSS on a page boundary so that all critical bytes are either present or not present. Then, if a page fault occurs when the TSS is accessed, it occurs before the first byte is read. If the page fault occurs after a portion of the TSS is read, the fault is unrecoverable.

**I/O-Permission Bitmap.** The I/O-permission bitmap (IOPB) allows system software to grant less-privileged programs access to individual I/O ports, overriding the effect of RFLAGS.IOPL for those devices. When an I/O instruction is executed, the processor checks the IOPB only if the processor is in virtual x86 mode or the CPL is greater than the RFLAGS.IOPL field. Each bit in the IOPB corresponds to a byte I/O port. A word I/O port corresponds to two consecutive IOPB bits, and a doubleword I/O port corresponds to four consecutive IOPB bits. Access is granted to an I/O port of a given size when *all* IOPB bits corresponding to that port are clear. If any bits are set, a #GP occurs.

The IOPB is located in the TSS, as shown by the example in Figure 12-7 on page 337. Each TSS can have a different copy of the IOPB, so access to individual I/O devices can be granted on a task-by-task basis. The I/O-permission bitmap base-address field located at byte 66h in the TSS is an offset into the TSS locating the start of the IOPB. If all 64K IO ports are supported, the IOPB base address must not be greater than 0DFFFh, otherwise accesses to the bitmap cause a #GP to occur. An extra byte must be present after the last IOPB byte. This byte must have all bits set to 1 (0FFh). This allows the processor to read two IOPB bytes each time an I/O port is accessed. By reading two IOPB bytes, the processor can check all bits when unaligned, multi-byte I/O ports are accessed.



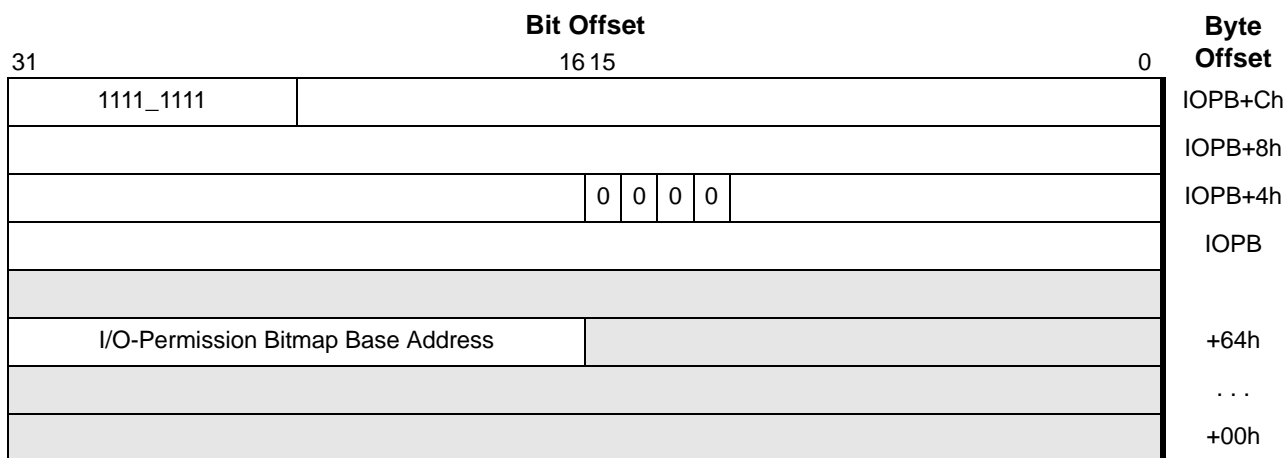

**Figure 12-7. I/O-Permission Bitmap Example**

Bits in the IOPB sequentially correspond to I/O port addresses. The example in Figure 12-7 shows bits 12 through 15 in the second doubleword of the IOPB cleared to 0. Those bit positions correspond to byte I/O ports 44h through 47h, or alternatively, doubleword I/O port 44h. Because the bits are cleared to zero, software running at any privilege level can access those I/O ports.

By adjusting the TSS limit, it may happen that some ports in the I/O-address space have no corresponding IOPB entry. Ports not represented by the IOPB will cause a #GP exception. Referring again to Figure 12-7, the last IOPB entry is at bit 23 in the fourth IOPB doubleword, which corresponds to I/O port 77h. In this example, all ports from 78h and above will cause a #GP exception, as if their permission bit was set to 1.

### 12.2.5 64-Bit Task State Segment

Although the hardware task-switching mechanism is not supported in long mode, a 64-bit task state segment (TSS) must still exist. System software must create at least one 64-bit TSS for use after activating long mode, and it must execute the LTR instruction, *in 64-bit mode*, to load the TR register with a pointer to the 64-bit TSS that serves both 64-bit-mode programs and compatibility-mode programs.

The legacy TSS contains several fields used for saving and restoring processor-state information. The legacy fields include general-purpose register, EFLAGS, CR3 and segment-selector register state, among others. Those legacy fields are not supported by the 64-bit TSS. System software must save and restore the necessary processor-state information required by the software-multitasking implementation (if multitasking is supported). Figure 12-8 on page 339 shows the format of a 64-bit TSS.

The 64-bit TSS holds several pieces of information important to long mode that are not directly related to the task-switch mechanism:

- *RSP<sub>n</sub>*—Bytes 1Bh–04h. The full 64-bit canonical forms of the stack pointers (RSP) for privilege levels 0 through 2.

- *IST<sub>n</sub>*—Bytes 5Bh–24h. The full 64-bit canonical forms of the interrupt-stack-table (IST) pointers. See “Interrupt-Stack Table” on page 251 for a description of the IST mechanism.
- *I/O Map Base Address*—Bytes 67h–66h. The 16-bit offset to the I/O-permission bit map from the 64-bit TSS base. The function of this field is identical to that in a legacy 32-bit TSS. See “I/O-Permission Bitmap” on page 336 for more information.

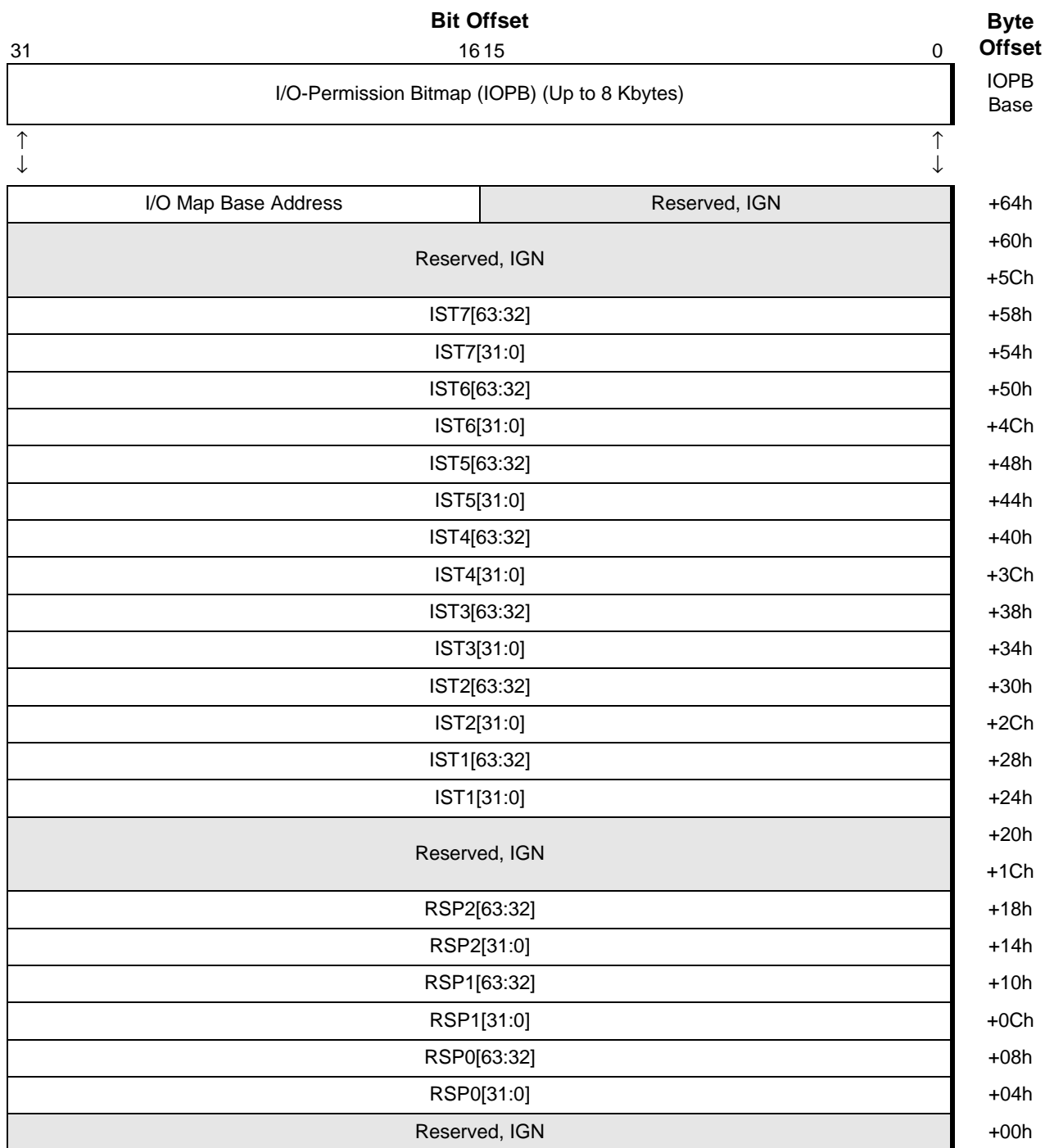
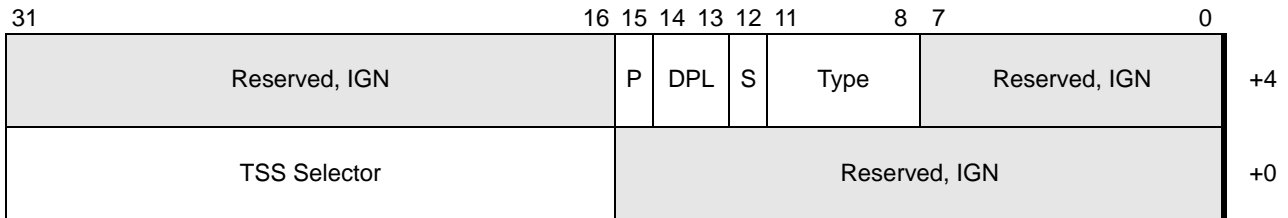

Figure 12-8. Long Mode TSS Format

### 12.2.6 Task Gate Descriptor (Legacy Mode Only)

Task-gate descriptors hold a selector reference to a TSS and are used to control access between tasks. Unlike a TSS descriptor or other gate descriptors, a task gate can be located in any of the three descriptor tables (GDT, LDT, and IDT). Figure 12-9 shows the format of a task-gate descriptor.



**Figure 12-9. Task-Gate Descriptor, Legacy Mode Only**

The task-gate descriptor fields are:

- *System (S) and Type*—Bits 12 and 11:8 (respectively) of byte +4. These bits are encoded by software as 00101b to indicate a task-gate descriptor type.
- *Present (P)*—Bit 15 of byte +4. The segment-present bit indicates the segment referenced by the gate descriptor is loaded in memory. If a reference is made to a segment when P=0, a segment-not-present exception (#NP) occurs. This bit is set and cleared by system software and is never altered by the processor.
- *Descriptor Privilege-Level (DPL)*—Bits 14:13 of byte +4. The DPL field indicates the gate-descriptor privilege level. DPL can be set to any value from 0 to 3, with 0 specifying the most privilege and 3 the least privilege.

## 12.3 Hardware Task-Management in Legacy Mode

This section describes the operation of the task-switch mechanism when the processor is running in legacy mode. None of these features are supported in long mode (either compatibility mode or 64-bit mode).

### 12.3.1 Task Memory-Mapping

The hardware task-switch mechanism gives system software a great deal of flexibility in managing the sharing and isolation of memory—both virtual (linear) and physical—between tasks.

**Segmented Memory.** The segmented memory for a task consists of the segments that are loaded during a task switch and any segments that are later accessed by the task code. The hardware task-switch mechanism allows tasks to either share segments with other tasks, or to access segments in isolation from one another. Tasks that share segments actually share a virtual-address (linear-address) space, but they do not necessarily share a physical-address space. When paging is enabled, the virtual-to-physical mapping for each task can differ, as is described in the following section. Shared segments

*do share* physical memory when paging is disabled, because virtual addresses are used as physical addresses.

A number of options are available to system software that shares segments between tasks:

- Sharing segment descriptors using the GDT. All tasks have access to the GDT, so it is possible for segments loaded in the GDT to be shared among tasks.
- Sharing segment descriptors using a single LDT. Each task has its own LDT, and that LDT selector is automatically saved and restored in the TSS by the processor during task switches. Tasks, however, can share LDTs simply by storing the same LDT selector in multiple TSSs. Using the LDT to manage segment sharing and segment isolation provides more flexibility to system software than using the GDT for the same purpose.
- Copying shared segment descriptors into multiple LDTs. Segment descriptors can be copied by system software into multiple LDTs that are otherwise not shared between tasks. Allowing segment sharing at the segment-descriptor level, rather than the LDT level or GDT level, provides the greatest flexibility to system software.

In all three cases listed above, the actual data and instructions are shared between tasks only when the tasks' virtual-to-physical address mappings are identical.

**Paged Memory.** Each task has its own page-translation table base-address (CR3) register, and that register is automatically saved and restored in the TSS by the processor during task switches. This allows each task to point to its own set of page-translation tables, so that each task can translate virtual addresses to physical addresses independently. Page translation must be enabled for changes in CR3 values to have an effect on virtual-to-physical address mapping. When page translation is disabled, the tables referenced by CR3 are ignored, and virtual addresses are equivalent to physical addresses.

### 12.3.2 Switching Tasks

The hardware task-switch mechanism transfers program control to a new task when any of the following occur:

- A CALL or JMP instruction with a selector operand that references a task gate is executed. The task gate can be located in either the LDT or GDT.
- A CALL or JMP instruction with a selector operand that references a TSS descriptor is executed. The TSS descriptor must be located in the GDT.
- A software-interrupt instruction (INT $n$ ) is executed that references a task gate located in the IDT.
- An exception or external interrupt occurs, and the vector references a task gate located in the IDT.
- An IRET is executed while the EFLAGS.NT bit is set to 1, indicating that a return is being performed from an inner-level task to an outer-level task. The new task is referenced using the selector stored in the current-task link field. See “Nesting Tasks” on page 345 for additional information. The RET instruction *cannot* be used to switch tasks.

When a task switch occurs, the following operations are performed automatically by the processor:

- The processor performs privilege-checking to determine whether the currently-executing program is allowed to access the target task. If this check fails, the task switch is aborted without modifying the processor state, and a general-protection exception (#GP) occurs. The privilege checks performed depend on the cause of the task switch:
  - If the task switch is initiated by a CALL or JMP instruction through a TSS descriptor, the processor checks that both the currently-executing program CPL and the TSS-selector RPL are numerically less-than or equal-to the TSS-descriptor DPL.
  - If the task switch takes place through a task gate, the CPL and task-gate RPL are compared with the task-gate DPL, and no comparison is made using the TSS-descriptor DPL. See “Task Switches Using Task Gates” on page 343.
  - Software interrupts, hardware interrupts, and exceptions all transfer control without checking the task-gate DPL.
  - The IRET instruction transfers control without checking the TSS-descriptor DPL.
- The processor performs limit-checking on the target TSS descriptor to verify that the TSS limit is greater than or equal to 67h (at least 104 bytes). If this check fails, the task switch is aborted without modifying the processor state, and an invalid-TSS exception (#TS) occurs.
- The current-task state is saved in the TSS. This includes the next-instruction pointer (EIP), EFLAGS, the general-purpose registers, and the segment-selector registers.

Up to this point, any exception that occurs aborts the task switch without changing the processor state. From this point forward, any exception that occurs does so in the context of the new task. If an exception occurs in the context of the new task during a task switch, the processor finishes loading the new-task state without performing additional checks. The processor transfers control to the #TS handler after this state is loaded, but before the first instruction is executed in the new task. When a #TS occurs, it is possible that some of the state loaded by the processor did not participate in segment access checks. The #TS handler must verify that all segments are accessible before returning to the interrupted task.

- The task register (TR) is loaded with the new-task TSS selector, and the hidden portion of the TR is loaded with the new-task descriptor. The TSS now referenced by the processor is that of the new task.
- The current task is marked as busy. The previous task is marked as available or remains busy, based on the type of linkage. See “Nesting Tasks” on page 345 for more information.
- CR0.TS is set to 1. This bit can be used to save other processor state only when it becomes necessary. For more information, see the next section, “Saving Other Processor State.”
- The new-task state is loaded from the TSS. This includes the next-instruction pointer (EIP), EFLAGS, the general-purpose registers, and the segment-selector registers. The processor clears the segment-descriptor present (P) bits (in the hidden portion of the segment registers) to prevent access into the new segments, until the task switch completes successfully.
- The LDTR and CR3 registers are loaded from the TSS, changing the virtual-to-physical mapping from that of the old task to the new task. Because this is done in the middle of accessing the new TSS, system software must guarantee that TSS addresses are translated identically in all tasks.

- The descriptors for all previously-loaded segment selectors are loaded into the hidden portion of the segment registers. This sets or clears the P bits for the segments as specified by the new descriptor values.

If the above steps complete successfully, the processor begins executing instructions in the new task beginning with the instruction referenced by the CS:EIP far pointer loaded from the new TSS. The privilege level of the new task is taken from the new CS segment selector's RPL.

**Saving Other Processor State.** The processor does not automatically save the registers used by the media or x87 instructions. Instead, the processor sets CR0.TS to 1 during a task switch. Later, when an attempt is made to execute any of the media or x87 instructions while TS=1, a device-not-available exception (#NM) occurs. System software can then save the previous state of the media and x87 registers and clear the CR0.TS bit to 0 before executing the next media/x87 instruction. As a result, the media and x87 registers are saved only when necessary after a task switch.

### 12.3.3 Task Switches Using Task Gates

When a control transfer to a new task occurs through a task gate, the processor reads the task-gate DPL ( $DPL_G$ ) from the task-gate descriptor. Two privilege checks, both of which must pass, are performed on  $DPL_G$  before the task switch can occur successfully:

- The processor compares the CPL with  $DPL_G$ . The CPL must be numerically *less than or equal to*  $DPL_G$  for this check to pass. In other words, the following expression must be true:  $CPL \leq DPL_G$ .
- The processor compares the RPL in the task-gate selector with  $DPL_G$ . The RPL must be numerically *less than or equal to*  $DPL_G$  for this check to pass. In other words, the following expression must be true:  $RPL \leq DPL_G$ .

Unlike call-gate control transfers, the processor does not read the DPL from the target TSS descriptor ( $DPL_S$ ) and compare it with the CPL when a task gate is used.

Figure 12-10 on page 344 shows two examples of task-gate privilege checks. In Example 1, the privilege checks pass:

- The task-gate DPL ( $DPL_G$ ) is at the lowest privilege (3), specifying that software running at any privilege level (CPL) can access the gate.
- The selector referencing the task gate passes its privilege check because the RPL is numerically less than or equal to  $DPL_G$ .

In Example 2, both privilege checks fail:

- The task-gate DPL ( $DPL_G$ ) specifies that only software at privilege-level 0 can access the gate. The current program does not have enough privilege to access the task gate, because its CPL is 2.
- The selector referencing the task-gate descriptor does not have a high enough privilege to complete the reference. Its RPL is numerically greater than  $DPL_G$ .

Although both privilege checks failed in the example, if only one check fails, access into the target task is denied.

Because the legacy task-switch mechanism is not supported in long mode, *software cannot use task gates in long mode*. Any attempt to transfer control to another task using a task gate in long mode causes a general-protection exception (#GP) to occur.

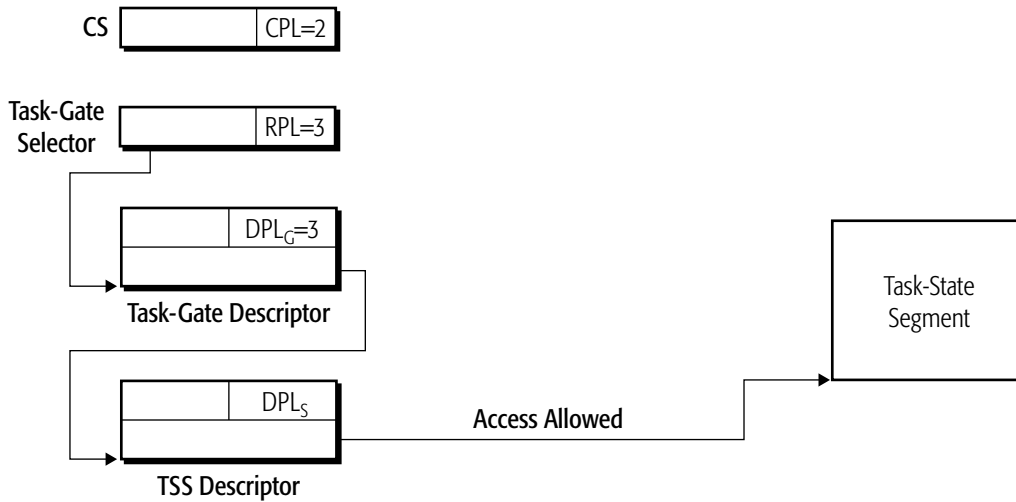

Example 1: Privilege Check Passes

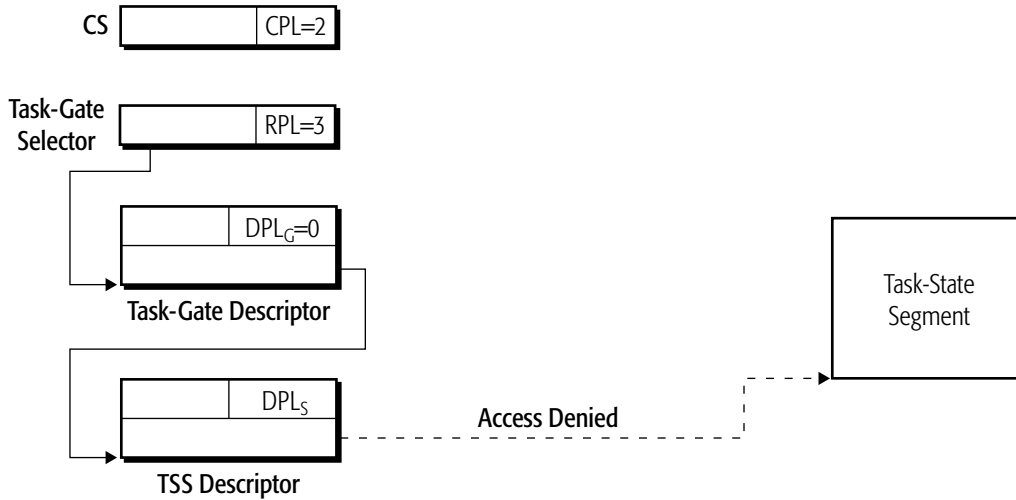

Example 2: Privilege Check Fails

Figure 12-10. Privilege-Check Examples for Task Gates



### 12.3.4 Nesting Tasks

The hardware task-switch mechanism supports task nesting through the use of EFLAGS *nested-task* (NT) bit and the TSS link-field. The manner in which these fields are updated and used during a task switch depends on how the task switch is initiated:

- The JMP instruction does not update EFLAGS.NT or the TSS link-field. Task nesting is not supported by the JMP instruction.
- The CALL instruction, INT $n$  instructions, interrupts, and exceptions can only be performed from outer-level tasks to inner-level tasks. All of these operations set the EFLAGS.NT bit for the new task to 1 during a task switch, and copy the selector for the previous task into the new-task link field.
- An IRET instruction which returns to another task only occurs when the EFLAGS.NT bit for the current task is set to 1, and only can be performed from an inner-level task to an outer-level task. When an IRET results in a task switch, the new task is referenced using the selector stored in the current-TSS link field. The EFLAGS.NT bit for the current task is cleared to 0 during the task switch.

Table 12-1 summarizes the effect various task-switch initiators have on EFLAGS.NT, the TSS link-field, and the TSS-busy bit. (For more information on the busy bit, see the next section, “Preventing Recursion.”)

**Table 12-1. Effects of Task Nesting**

Task-Switch Initiator	Old Task			New Task		
	EFLAGS.NT	Link (Selector)	Busy	EFLAGS.NT	Link (Selector)	Busy
JMP	—	—	Clear to 0 (was 1)	—	—	Set to 1
CALL INT $n$ Interrupt Exception	—	—	— (Was 1)	Set to 1	Old Task	Set to 1
IRET	Clear to 0 (was 1)	—	Clear to 0 (was 1)	—	—	—

**Note:**  
“—” indicates no change is made.

Programs running at any privilege level can set EFLAGS.NT to 1 and execute the IRET instruction to transfer control to another task. System software can keep control over improperly nested-task switches by initializing the link field of all TSSs that it creates. That way, improperly nested-task switches always transfer control to a known task.

**Preventing Recursion.** Task recursion is not allowed by the hardware task-switch mechanism. If recursive-task switches were allowed, they would replace a previous task-state image with a newer image, discarding the previous information. To prevent recursion from occurring, the processor uses

the busy bit located in the TSS-descriptor type field (bit 9 of byte +4). Use of this bit depends on how the task switch is initiated:

- The JMP instruction clears the busy bit in the old task to 0 and sets the busy bit in the new task to 1. A general-protection exception (#GP) occurs if an attempt is made to JMP to a task with a set busy bit.
- The CALL instruction, INT $n$  instructions, interrupts, and exceptions set the busy bit in the new task to 1. The busy bit in the old task remains set to 1, preventing recursion through task-nesting levels. A general-protection exception (#GP) occurs if an attempt is made to switch to a task with a set busy bit.
- An IRET to another task (EFLAGS.NT must be 1) clears the busy bit in the old task to 0. The busy bit in the new task is not altered, because it was already set to 1.

Table 12-1 on page 345 summarizes the effect various task-switch initiators have on the TSS-busy bit.

## 13 Software Debug and Performance Resources

---

Testing, debug, and performance optimization consume a significant portion of the time needed to develop a new computer or software product and move it successfully into production. To stay competitive, product developers need tools that allow them to rapidly detect, isolate, and correct problems before a product is shipped. The goal of the debug and performance features incorporated into processor implementations of the AMD64 architecture is to support the tool chain solutions used in software and hardware product development.

The debug and performance resources that can be supported by AMD64 architecture implementations include:

- *Software Debug*—software-debug facilities include the debug registers (DR0–DR7), debug exception, and breakpoint exception. Additional features are provided using model-specific registers (MSRs). These registers are used to set breakpoints on branches, interrupts, and exceptions and to single step from one branch to the next. The software-debug capability is described in the following section.
- *Performance Monitoring Counters*—Performance monitoring counters (PMCs) are provided to count specific processor hardware events. A set of control registers allow the selection of events to be monitored and a corresponding set of counter registers track the frequency of monitored events. These counters are described in Section 13.2 “Performance Monitoring Counters” on page 362.
- *Instruction-Based Sampling*—Instruction-based sampling is a hardware-based facility that enables system software to capture specific data concerning instruction fetch and instruction execution operation based on random sampling. This facility is described in Section 13.3 “Instruction-Based Sampling” on page 371.
- *Lightweight Profiling*—AMD64 architecture provides instructions that allow user-level programs to manage the gathering of instruction statistics using very little overhead. This facility is described in Section 13.4 “Lightweight Profiling” on page 384.

Although a subset of the facilities listed are available in all processor implementations, the remainder are optional. Support for optional facilities is indicated via CPUID feature bits. The means of determining support for each architected facility is described along with the facility in the sections that follow.

A given processor product may include additional debug and performance monitoring capabilities beyond those which are architecturally-defined. For details see the *BIOS and Kernel Developer’s Guide* applicable to your product.

## 13.1 Software-Debug Resources

Software can program breakpoints into the debug registers, causing a debug exception (#DB) when matches occur on instruction-memory addresses, data-memory addresses, or I/O addresses. The breakpoint exception (#BP) is also supported to allow software to set breakpoints by placing INT3 instructions in the instruction memory for a program. Program control is transferred to the breakpoint exception (#BP) handler when an INT3 instruction is executed.

In addition to the debug features supported by the debug registers (DR0–DR7), the processor also supports features supported by model-specific registers (MSRs). Together, these capabilities provide a rich set of breakpoint conditions, including:

- *Breakpoint On Address Match*—Breakpoints occur when the address stored in a address-breakpoint register matches the address of an instruction or data reference. Up to four address-match breakpoint conditions can be set by software.
- *Single Step All Instructions*—Breakpoints can be set to occur on every instruction, allowing a debugger to examine the contents of registers as a program executes.
- *Single Step Control Transfers*—Breakpoints can be set to occur on control transfers, such as calls, jumps, interrupts, and exceptions. This can allow a debugger to narrow a problem search to a specific section of code before enabling single stepping of all instructions.
- *Breakpoint On Any Instruction*—Breakpoints can be set on any specific instruction using either the address-match breakpoint condition or using the INT3 instruction to force a breakpoint when the instruction is executed.
- *Breakpoint On Task Switch*—Software forces a #DB exception to occur when a task switch is performed to a task with the T bit in the TSS set to 1. Debuggers can use this capability to enable or disable debug conditions for a specific task.

Problem areas can be identified rapidly using the information supplied by the debug registers when breakpoint conditions occur:

- Special conditions that cause a #DB exception are recorded in the DR6 debug-status register, including breakpoints due to task switches and single stepping. The DR6 register also identifies which address-breakpoint register (DR0–DR3) caused a #DB exception due to an address match. When combined with the DR7 debug-control register settings, the cause of a #DB exception can be identified.
- To assist in analyzing the instruction sequence a processor follows in reaching its current state, the source and destination addresses of control-transfer events are saved by the processor. These include branches (calls and jumps), interrupts, and exceptions. Debuggers can use this information to narrow a problem search to a specific section of code before single stepping all instructions.

### 13.1.1 Debug Registers

The AMD64 architecture supports the legacy debug registers, DR0–DR7. These registers are expanded to 64 bits by the AMD64 architecture. In legacy mode and in compatibility mode, only the lower 32 bits are used. In these modes, writes to a debug register fill the upper 32 bits with zeros, and

reads from a debug register return only the lower 32 bits. In 64-bit mode, all 64 bits of the debug registers are read and written. Operand-size prefixes are ignored.

The debug registers can be read and written only when the current-protection level (CPL) is 0 (most privileged). Attempts to read or write the registers at a lower-privilege level (CPL>0) cause a general-protection exception (#GP).

Several debug registers described below are model-specific registers (MSRs). See “Software-Debug MSRs” on page 575 for a listing of the debug-MSR numbers and their reset values. Some processor implementations include additional MSRs used to support implementation-specific software debug features. For more information on these registers and their capabilities, see the *BIOS and Kernel Developer’s Guide* applicable to your product.

### 13.1.1.1 Address-Breakpoint Registers (DR0-DR3)

Figure 13-1 shows the format of the four address-breakpoint registers, DR0-DR3. Software can load a virtual (linear) address into any of the four registers, and enable breakpoints to occur when the address matches an instruction or data reference. The MOV DR $n$  instructions *do not* check that the virtual addresses loaded into DR0-DR3 are in canonical form. Breakpoint conditions are enabled using the debug-control register, DR7 (see “Debug-Control Register (DR7)” on page 351).

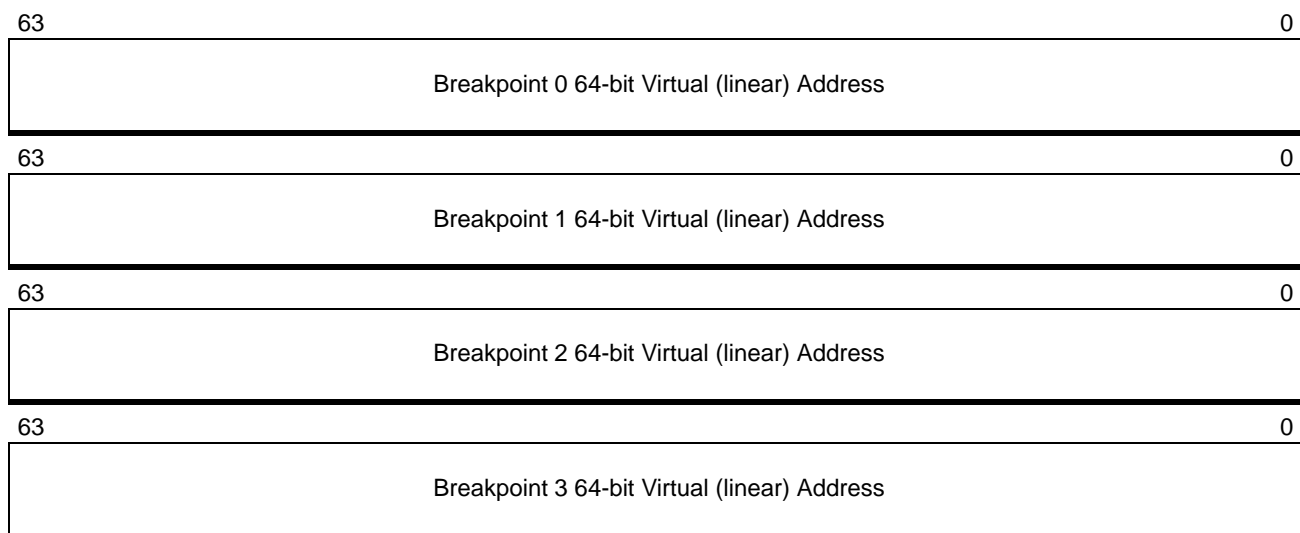

**Figure 13-1. Address-Breakpoint Registers (DR0-DR3)**

### 13.1.1.2 Reserved Debug Registers (DR4, DR5)

The DR4 and DR5 registers are reserved and should not be used by software. These registers are aliased to the DR6 and DR7 registers, respectively. When the debug extensions are enabled (CR4[DE] = 1) attempts to access these registers cause an invalid-opcode exception (#UD).

### 13.1.1.3 Debug-Status Register (DR6)

Figure 13-2 on page 350 shows the format of the debug-status register, DR6[Debug] status is loaded into DR6 when an enabled debug condition is encountered that causes a #DB exception.

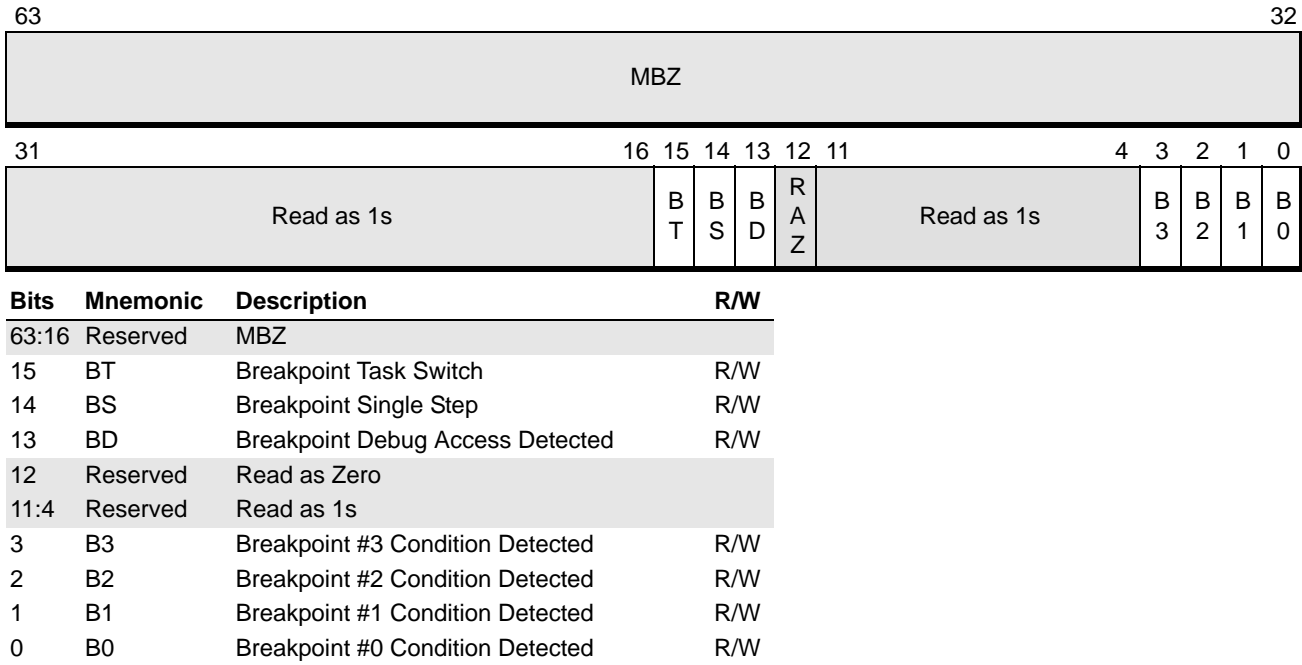

**Figure 13-2. Debug-Status Register (DR6)**

Bits 15:13 of the DR6 register are not cleared by the processor and must be cleared by software after the contents have been read. Register fields are:

- *Breakpoint-Condition Detected (B3–B0)*—Bits 3:0. The processor updates these four bits on every debug breakpoint or general-detect condition. A bit is set to 1 if the corresponding address-breakpoint register detects an enabled breakpoint condition, as specified by the DR7 *Ln*, *Gn*, *R/Wn* and *LENn* controls, and is cleared to 0 otherwise. For example, B1 (bit 1) is set to 1 if an address-breakpoint condition is detected by DR1.
- *Debug-Register-Access Detected (BD)*—Bit 13. The processor sets this bit to 1 if software accesses any debug register (DR0–DR7) while the general-detect condition is enabled (DR7[GD] = 1).
- *Single Step (BS)*—Bit 14. The processor sets this bit to 1 if the #DB exception occurs as a result of single-step mode (rFLAGS[TF] = 1). Single-step mode has the highest-priority among debug exceptions. Other status bits within the DR6 register can be set by the processor along with the BS bit.
- *Task-Switch (BT)*—Bit 15. The processor sets this bit to 1 if the #DB exception occurred as a result of task switch to a task with a TSS T-bit set to 1.

All remaining bits in the DR6 register are reserved. Reserved bits 31:16 and 11:4 must all be set to 1, while reserved bit 12 must be cleared to 0. In 64-bit mode, the upper 32 bits of DR6 are reserved and must be written with zeros. Writing a 1 to any of the upper 32 bits results in a general-protection exception, #GP(0).

### 13.1.1.4 Debug-Control Register (DR7)

Figure 13-3 shows the format of the debug-control register, DR7. DR7 is used to establish the breakpoint conditions for the address-breakpoint registers (DR0–DR3) and to enable debug exceptions for each address-breakpoint register individually. DR7 is also used to enable the general-detect breakpoint condition.

Bits	Mnemonic	Description	R/W
63:32	—	Reserved, MBZ	
31:30	LEN3	Length of Breakpoint #3	R/W
29:28	R/W3	Type of Transaction(s) to Trap	R/W
27:26	LEN2	Length of Breakpoint #2	R/W
25:24	R/W2	Type of Transaction(s) to Trap	R/W
23:22	LEN1	Length of Breakpoint #1	R/W
21:20	R/W1	Type of Transaction(s) to Trap	R/W
19:18	LEN0	Length of Breakpoint #0	R/W
17:16	R/W0	Type of Transaction(s) to Trap	R/W
15:14	—	Reserved, RAZ	
13	GD	General Detect Enabled	R/W
12:11	—	Reserved, RAZ	
10	—	Reserved, read as 1	
9	GE	Global Exact Breakpoint Enabled	R/W
8	LE	Local Exact Breakpoint Enabled	R/W
7	G3	Global Exact Breakpoint #3 Enabled	R/W
6	L3	Local Exact Breakpoint #3 Enabled	R/W
5	G2	Global Exact Breakpoint #2 Enabled	R/W
4	L2	Local Exact Breakpoint #2 Enabled	R/W
3	G1	Global Exact Breakpoint #1 Enabled	R/W
2	L1	Local Exact Breakpoint #1 Enabled	R/W
1	G0	Global Exact Breakpoint #0 Enabled	R/W
0	L0	Local Exact Breakpoint #0 Enabled	R/W

Figure 13-3. Debug-Control Register (DR7)

The fields within the DR7 register are all read/write. These fields are:

- *Local-Breakpoint Enable (L3–L0)*—Bits 6, 4, 2, and 0 (respectively). Software individually sets these bits to 1 to enable debug exceptions to occur when the corresponding address-breakpoint register (DR $n$ ) detects a breakpoint condition while executing the *current* task. For example, if L1 (bit 2) is set to 1 and an address-breakpoint condition is detected by DR1, a #DB exception occurs. These bits are cleared to 0 by the processor when a hardware task-switch occurs.
- *Global-Breakpoint Enable (G3–G0)*—Bits 7, 5, 3, and 1 (respectively). Software sets these bits to 1 to enable debug exceptions to occur when the corresponding address-breakpoint register (DR $n$ ) detects a breakpoint condition while executing *any* task. For example, if G1 (bit 3) is set to 1 and an address-breakpoint condition is detected by DR1, a #DB exception occurs. These bits are never cleared to 0 by the processor.
- *Local-Enable (LE)*—Bit 8. Software sets this bit to 1 in legacy implementations to enable exact breakpoints while executing the *current* task. This bit is ignored by implementations of the AMD64 architecture. All breakpoint conditions, except certain string operations preceded by a repeat prefix, are exact.
- *Global-Enable (GE)*—Bit 9. Software sets this bit to 1 in legacy implementations to enable exact breakpoints while executing *any* task. This bit is ignored by implementations of the AMD64 architecture. All breakpoint conditions, except certain string operations preceded by a repeat prefix, are exact.
- *General-Detect Enable (GD)*—Bit 13. Software sets this bit to 1 to cause a debug exception to occur when an attempt is made to execute a MOV DR $n$  instruction to any debug register (DR0–DR7). This bit is cleared to 0 by the processor when the #DB handler is entered, allowing the handler to read and write the DR $n$  registers. The #DB exception occurs before executing the instruction, and DR6[BD] is set by the processor. Software debuggers can use this bit to prevent the currently-executing program from interfering with the debug operation.
- *Read/Write (R/W3–R/W0)*—Bits 29:28, 25:24, 21:20, and 17:16 (respectively). Software sets these fields to control the breakpoint conditions used by the corresponding address-breakpoint registers (DR $n$ ). For example, control-field R/W1 (bits 21:20) controls the breakpoint conditions for the DR1 register. The R/W $n$  control-field encodings specify the following conditions for an address-breakpoint to occur:
  - 00—Only on instruction execution.
  - 01—Only on data write.
  - 10—This encoding is further qualified by CR4[DE] as follows:
    - . CR4[DE] = 0—Condition is undefined.
    - . CR4[DE] = 1—Only on I/O read or I/O write.
  - 11—Only on data read or data write.
- *Length (LEN3–LEN0)*—Bits 31:30, 27:26, 23:22, and 19:18 (respectively). Software sets these fields to control the range used in comparing a memory address with the corresponding address-breakpoint register (DR $n$ ). For example, control-field LEN1 (bits 23:22) controls the breakpoint-comparison range for the DR1 register.



The value in  $DR_n$  defines the low-end of the address range used in the comparison.  $LEN_n$  is used to mask the low-order address bits in the corresponding  $DR_n$  register so that they are not used in the address comparison. To work properly, breakpoint boundaries must be aligned on an address corresponding to the range size specified by  $LEN_n$ . The  $LEN_n$  control-field encodings specify the following address-breakpoint-comparison ranges:

- 00—1 byte.
- 01—2 byte, must be aligned on a word boundary.
- 10—8 byte, must be aligned on a quadword boundary. (Long mode only; otherwise undefined.)
- 11—4 byte, must be aligned on a doubleword boundary.

If the  $R/W_n$  field is used to specify instruction breakpoints ( $R/W_n=00$ ), the corresponding  $LEN_n$  field must be set to 00. Setting  $LEN_n$  to any other value produces undefined results.

All remaining bits in the  $DR_7$  register are reserved. Reserved bits 15:14 and 12:11 must all be cleared to 0, while reserved bit 10 must be set to 1. In 64-bit mode, the upper 32 bits of  $DR_7$  are reserved and must be written with zeros. Writing a 1 to any of the upper 32 bits results in a general-protection  $\#GP(0)$  exception.

#### 13.1.1.5 64-Bit-Mode Extended Debug Registers

In 64-bit mode, additional encodings for debug registers are available. The R bit of the REX prefix is used to modify the ModRM *reg* field when that field encodes a control register. These additional encodings enable the processor to address  $DR_8$ – $DR_{15}$ .

Access to the  $DR_8$ – $DR_{15}$  registers is implementation-dependent. The architecture does not require any of these extended debug registers to be implemented. Any attempt to access an unimplemented register results in an invalid-opcode exception ( $\#UD$ ).

#### 13.1.1.6 Debug-Control MSR (DebugCtl)

Figure 13-4 on page 354 shows the format of the debug-control MSR (DebugCtl). DebugCtl provides additional debug controls over control-transfer recording and single stepping, and external-breakpoint reporting and trace messages. DebugCtl is read and written using the RDMSR and WRMSR instructions.

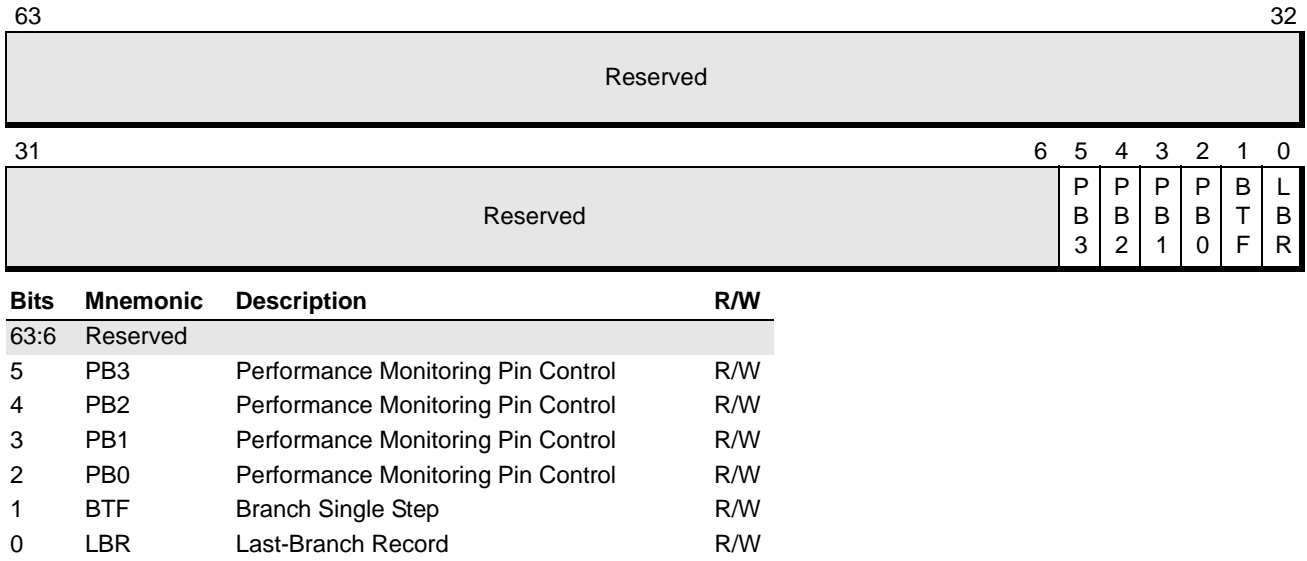

**Figure 13-4. Debug-Control MSR (DebugCtl)**

The fields within the DebugCtl register are:

- *Last-Branch Record (LBR)*—Bit 0, read/write. Software sets this bit to 1 to cause the processor to record the source and target addresses of the last control transfer taken before a debug exception occurs. The recorded control transfers include branch instructions, interrupts, and exceptions. See “Control-Transfer Breakpoint Features” on page 360 for more details on the registers. See Figure 13-5 on page 355 for the format of the control-transfer recording MSRs.
- *Branch Single Step (BTF)*—Bit 1, read/write. Software uses this bit to change the behavior of the rFLAGS[TF] bit. When this bit is cleared to 0, the rFLAGS[TF] bit controls instruction single stepping, (normal behavior). When this bit is set to 1, the rFLAGS[TF] bit controls single stepping on control transfers. The single-stepped control transfers include branch instructions, interrupts, and exceptions. Control-transfer single stepping requires both BTF = 1 and rFLAGS[TF] = 1. See “Control-Transfer Breakpoint Features” on page 360 for more details on control-transfer single stepping.
- *Performance-Monitoring/Breakpoint Pin-Control (PBi)*—Bits 5:2, read/write. Software uses these bits to control the type of information reported by the four external performance-monitoring/breakpoint pins on the processor. When a PB<sub>i</sub> bit is cleared to 0, the corresponding external pin (BP<sub>i</sub>) reports performance-monitor information. When a PB<sub>i</sub> bit is set to 1, the corresponding external pin (BP<sub>i</sub>) reports breakpoint information.

All remaining bits in the DebugCtl register are reserved.

### 13.1.1.7 Control-Transfer Recording MSRs

Figure 13-5 on page 355 shows the format of the 64-bit control-transfer recording MSRs: LastBranchToIP, LastBranchFromIP, LastIntToIP, and LastIntFromIP. These registers are loaded automatically by the processor when the DebugCtl[LBR] bit is set to 1. These MSRs are read-only.

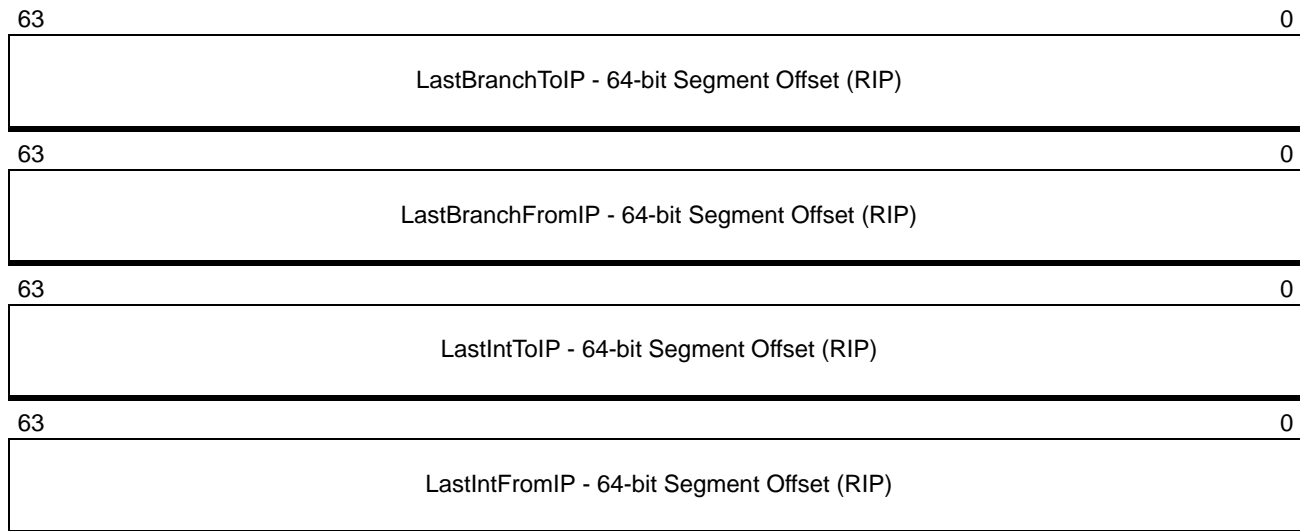

**Figure 13-5. Control-Transfer Recording MSRs**

### 13.1.2 Setting Breakpoints

Breakpoints can be set to occur on either instruction addresses or data addresses using the breakpoint-address registers, DR0–DR3 ( $DR_n$ ). The values loaded into these registers represent the breakpoint-location virtual address. The debug-control register, DR7, is used to enable the breakpoint registers and to specify the type of access and the range of addresses that can trigger a breakpoint.

Software enables the  $DR_n$  registers using the corresponding local-breakpoint enable ( $Ln$ ) or global-breakpoint enable ( $Gn$ ) found in the DR7 register.  $Ln$  is used to enable breakpoints only while the current task is active, and it is cleared by the processor when a task switch occurs.  $Gn$  is used to enable breakpoints for all tasks, and it is never cleared by the processor.

The R/W $n$  fields in DR7, along with the CR4[DE] bit, specify the type of access required to trigger a breakpoint when an address match occurs on the corresponding  $DR_n$  register. Breakpoints can be set to occur on instruction execution, data reads and writes, and I/O reads and writes. The R/W $n$  and CR4[DE] encodings used to specify the access type are described on page 352 of “Debug-Control Register (DR7).”

The LEN $n$  fields in DR7 specify the size of the address range used in comparison with data or instruction addresses. LEN $n$  is used to mask the low-order address bits in the corresponding  $DR_n$  register so that they are not used in the address comparison. Breakpoint boundaries must be aligned on an address corresponding to the range size specified by LEN $n$ . Assuming the access type matches the

type specified by R/Wn, a breakpoint occurs if any accessed byte falls within the range specified by LENn. For instruction breakpoints, LENn must specify a single-byte range. The LENn encodings used to specify the address range are described on page 352 of “Debug-Control Register (DR7).”

Table 13-1 shows several examples of data accesses, and whether or not they cause a #DB exception to occur based on the breakpoint address in DRn and the breakpoint-address range specified by LENn. In this table, R/Wn always specifies read/write access.

**Table 13-1. Breakpoint-Setting Examples**

Data-Access Address (hexadecimal)	Access Size (bytes)	Byte-Addresses in Data-Access (hexadecimal)	Breakpoint-Address Range (hexadecimal)	Result
DRn=F000, LENn=00 (1 Byte)				
EFFB	8	EFFB, EFFC, EFFD, EFFE, EFFF, F000, F001	F000	#DB
EFFE	2	EFFE, EFFF		—
	4	EFFE, EFFF, F000, F001		#DB
F000	1	F000		—
F001	2	F001, F002		—
F005	4	F005, F006, F007, F008		—
DRn=F004, LENn=11 (4 Bytes)				
EFFB	8	EFFB, EFFC, EFFD, EFFE, EFFF, F000, F001	F004–F007	—
EFFE	2	EFFE, EFFF		
	4	EFFE, EFFF, F000, F001		
F000	1	F000		
F001	2	F001, F002		
F005	4	F005, F006, F007, F008		#DB
DRn=F005, LENn=10 (8 Bytes)				
EFFB	8	EFFB, EFFC, EFFD, EFFE, EFFF, F000, F001	F000–F007	#DB
EFFE	2	EFFE, EFFF		—
	4	EFFE, EFFF, F000, F001		#DB
F000	1	F000		
F001	2	F001, F002		
F005	4	F005, F006, F007, F008		
<b>Note:</b> “—” indicates no #DB occurs.				

### 13.1.3 Using Breakpoints

A debug exception (#DB) occurs when an enabled-breakpoint condition is encountered during program execution. The debug-handler must check the debug-status register (DR6), the conditions enabled by the debug-control register (DR7), and the debug-control MSR (DebugCtl), to determine the #DB cause. The #DB exception corresponds to interrupt vector 1. See “#DB—Debug Exception (Vector 1)” on page 217.

Instruction breakpoints and general-detect conditions cause the #DB exception to occur *before* the instruction is executed, while all other breakpoint and single-stepping conditions cause the #DB exception to occur *after* the instruction is executed. Table 13-2 summarizes where the #DB exception occurs based on the breakpoint condition.

**Table 13-2. Breakpoint Location by Condition**

Breakpoint Condition	Breakpoint Location
Instruction	Before Instruction is Executed
General Detect	
Data Write Only	
Data Read or Data Write	After Instruction is Executed <sup>1</sup>
I/O Read or I/O Write	
Single Step <sup>1</sup>	After Instruction is Executed
Task Switch	
<b>Note:</b>	
1. Repeated operations (REP prefix) can breakpoint between iterations.	

Instruction breakpoints and general-detect conditions have a lower interrupt-priority than the other breakpoint and single-stepping conditions (see “Priorities” on page 232). Data-breakpoint conditions on the *previous* instruction occur before an instruction-breakpoint condition on the *next* instruction. However, if instruction and data breakpoints can occur as a result of executing a *single* instruction, the instruction breakpoint occurs first (before the instruction is executed), followed by the data breakpoint (after the instruction is executed).

#### 13.1.3.1 Instruction Breakpoints

Instruction breakpoints are set by loading a breakpoint-address register (DR $n$ ) with the desired instruction virtual-address, and then setting the corresponding DR7 fields as follows:

- Ln or Gn is set to 1 to enable the breakpoint for either the local task or all tasks, respectively.
- R/Wn is set to 00b to specify that the contents of DR $n$  are to be compared only with the virtual address of the next instruction to be executed.
- LEN $n$  must be set to 00b.

When a #DB exception occurs due to an instruction breakpoint-address in DR $n$ , the corresponding B $n$  field in DR6 is set to 1 to indicate that a breakpoint condition occurred. The breakpoint occurs before

the instruction is executed, and the breakpoint-instruction address is pushed onto the debug-handler stack. If multiple instruction breakpoints are set, the debug handler can use the  $B_n$  field to identify which register caused the breakpoint.

Returning from the debug handler causes the breakpoint instruction to be executed. Before returning from the debug handler, the  $rFLAGS[RF]$  bit should be set to 1 to prevent a reoccurrence of the #DB exception due to the instruction-breakpoint condition. The processor ignores instruction-breakpoint conditions when  $rFLAGS[RF] = 1$ , until after the next instruction (in this case, the breakpoint instruction) is executed. After the next instruction is executed, the processor clears  $rFLAGS[RF]$ .

### 13.1.3.2 Data Breakpoints

Data breakpoints are set by loading a breakpoint-address register ( $DR_n$ ) with the desired data virtual-address, and then setting the corresponding DR7 fields as follows:

- $Ln$  or  $Gn$  is set to 1 to enable the breakpoint for either the local task or all tasks, respectively.
- $R/W_n$  is set to 01b to specify that the data virtual-address is compared with the contents of  $DR_n$  only during a memory-write. Setting this field to 11b specifies that the comparison takes place during both memory reads and memory writes.
- $LEN_n$  is set to 00b, 01b, 11b, or 10b to specify an address-match range of one, two, four, or eight bytes, respectively. Long mode must be active to set  $LEN_n$  to 10b.

When a #DB exception occurs due to a data breakpoint address in  $DR_n$ , the corresponding  $B_n$  field in DR6 is set to 1 to indicate that a breakpoint condition occurred. The breakpoint occurs after the data-access instruction is executed, which means that the original data is overwritten by the data-access instruction. If the debug handler needs to report the previous data value, it must save that value before setting the breakpoint.

Because the breakpoint occurs after the data-access instruction is executed, the address of the instruction following the data-access instruction is pushed onto the debug-handler stack. Repeated string instructions, however, can trigger a breakpoint before all iterations of the repeat loop have completed. When this happens, the address of the string instruction is pushed onto the stack during a #DB exception if the repeat loop is not complete. A subsequent IRET from the #DB handler returns to the string instruction, causing the remaining iterations to be executed. Most implementations cannot report breakpoints exactly for repeated string instructions, but instead report the breakpoint on an iteration later than the iteration where the breakpoint occurred.

### 13.1.3.3 I/O Breakpoints

I/O breakpoints are set by loading a breakpoint-address register ( $DR_n$ ) with the I/O-port address to be trapped, and then setting the corresponding DR7 fields as follows:

- $Ln$  or  $Gn$  is set to 1 to enable the breakpoint for either the local task or all tasks, respectively.
- $R/W_n$  is set to 10b to specify that the I/O-port address is compared with the contents of  $DR_n$  only during execution of an I/O instruction. This encoding of  $R/W_n$  is valid only when debug extensions are enabled ( $CR4[DE] = 1$ ).

- $LEN_n$  is set to 00b, 01b, or 11b to specify the breakpoint occurs on a byte, word, or doubleword I/O operation, respectively.

The I/O-port address specified by the I/O instruction is zero extended by the processor to 64 bits before comparing it with the  $DR_n$  registers.

When a #DB exception occurs due to an I/O breakpoint in  $DR_n$ , the corresponding  $B_n$  field in  $DR_6$  is set to 1 to indicate that a breakpoint condition occurred. The breakpoint occurs after the instruction is executed, which means that the original data is overwritten by the breakpoint instruction. If the debug handler needs to report the previous data value, it must save that value before setting the breakpoint.

Because the breakpoint occurs after the instruction is executed, the address of the instruction following the I/O instruction is pushed onto the debug-handler stack, in most cases. In the case of *INS* and *OUTS* instructions that use the repeat prefix, however, the breakpoint occurs after the first iteration of the repeat loop. When this happens, the I/O-instruction address can be pushed onto the stack during a #DB exception if the repeat loop is not complete. A subsequent return from the debug handler causes the next I/O iteration to be executed. If the breakpoint condition is still set, the #DB exception reoccurs after that iteration is complete.

#### 13.1.3.4 Task-Switch Breakpoints

Breakpoints can be set in a task TSS to raise a #DB exception after a task switch. Software enables a task breakpoint by setting the T bit in the TSS to 1. When a task switch occurs into a task with the T bit set, the processor completes loading the new task state. Before the first instruction is executed, the #DB exception occurs, and the processor sets  $DR_6[BT]$  to 1, indicating that the #DB exception occurred as a result of task breakpoint.

The processor does not clear the T bit in the TSS to 0 when the #DB exception occurs. Software must explicitly clear this bit to disable the task breakpoint. Software should never set the T-bit in the debug-handler TSS if a separate task is used for #DB exception handling, otherwise the processor loops on the debug handler.

#### 13.1.3.5 General-Detect Condition

General-detect is a special debug-exception condition that occurs when software running at any privilege level attempts to access any of the  $DR_n$  registers while  $DR_7[GD]$  is set to 1. When a #DB exception occurs due to the general-detect condition, the processor clears  $DR_7[GD]$  and sets  $DR_6[BD]$  to 1. Clearing  $DR_7[GD]$  allows the debug handler to access the  $DR_n$  registers without causing infinite #DB exceptions.

A debugger enables general detection to prevent other software from accessing and interfering with the debug registers while they are in use by the debugger. The exception is taken before executing the *MOV*  $DR_n$  instruction so that the  $DR_n$  contents are not altered.

### 13.1.4 Single Stepping

Single-step breakpoints are enabled by setting the rFLAGS[TF] bit to 1. When single stepping is enabled, a #DB exception occurs after every instruction is executed until it is disabled by clearing rFLAGS[TF]. However, the instruction that sets the TF bit, and the instruction that follows it, is *not* single stepped.

When a #DB exception occurs due to single stepping, the processor clears rFLAGS[TF] before entering the debug handler, so that the debug handler itself is not single stepped. The processor also sets DR6[BS] to 1, which indicates that the #DB exception occurred as a result of single stepping. The rFLAGS image pushed onto the debug-handler stack has the TF bit set, and single stepping resumes when a subsequent IRET pops the stack image into the rFLAGS register.

Single-step breakpoints have a higher priority than external interrupts. If an external interrupt occurs during single stepping, control is transferred to the #DB handler first, causing the rFLAGS[TF] bit to be cleared. Next, before the first instruction in the debug handler is executed, the processor transfers control to the pending-interrupt handler. This allows external interrupts to be handled outside of single-step mode.

The INT $n$ , INT3, and INTO instructions clear the rFLAGS[TF] bit when they are executed. If a debugger is used to single-step software that contains these instructions, it must emulate them instead of executing them.

The single-step mechanism can also be set to single step only control transfers, rather than single step every instruction. See “Single Stepping Control Transfers” on page 361 for additional information.

### 13.1.5 Breakpoint Instruction (INT3)

The INT3 instruction, or the INT $n$  instruction with an operand of 3, can be used to set breakpoints that transfer control to the breakpoint-exception (#BP) handler rather than the debug-exception handler. When a debugger uses the breakpoint instructions to set breakpoints, it does so by replacing the first bytes of an instruction with the breakpoint instruction. The debugger replaces the breakpoint instructions with the original-instruction bytes to clear the breakpoint.

INT3 is a single-byte instruction while INT $n$  with an operand of 3 is a two-byte instruction. The instructions have slightly different effects on the breakpoint exception-handler stack. See “#BP—Breakpoint Exception (Vector 3)” on page 218 for additional information on this exception.

### 13.1.6 Control-Transfer Breakpoint Features

A control transfers is accomplished by using one of following instructions:

- JMP, CALL, RET
- Jcc, Jrcxz, LOOPcc
- JMPF, CALLF, RETF
- INT $n$ , INT 3, INTO, ICEBP



- Exceptions, IRET
- SYSCALL, SYSRET, SYSENTER, SYSEXIT
- INTR, NMI, SMI, RSM

### 13.1.6.1 Recording Control Transfers

Software enables control-transfer recording by setting `DebugCtl[LBR]` to 1. When this bit is set, the processor updates the recording MSR's automatically when control transfers occur:

- *LastBranchFromIP and LastBranchToIP Registers*—On branch instructions, the `LastBranchFromIP` register is loaded with the segment offset of the branch instruction, and the `LastBranchToIP` register is loaded with the first instruction to be executed after the branch. On interrupts and exceptions, the `LastBranchFromIP` register is loaded with the segment offset of the interrupted instruction, and the `LastBranchToIP` register is loaded with the offset of the interrupt or exception handler.
- *LastIntFromIP and LastIntToIP Registers*—The processor loads these from the `LastBranchFromIP` register and the `LastBranchToIP` register, respectively, when most interrupts and exceptions are taken. These two registers are not updated, however, when `#DB` or `#MC` exceptions are taken, or the `ICEBP` instruction is executed.

The processor automatically disables control-transfer recording when a debug exception (`#DB`) occurs by clearing `DebugCtl[LBR]` to 0. The contents of the control-transfer recording MSR's are not altered by the processor when the `#DB` occurs. Before exiting the debug-exception handler, software can set `DebugCtl[LBR]` to 1 to re-enable the recording mechanism.

Debuggers can trace a control transfer backward from a bug to its source using the recording MSR's and the breakpoint-address registers. The debug handler does this by updating the breakpoint registers from the recording MSR's after a `#DB` exception occurs, and restarting the program. The program takes a `#DB` exception on the previous control transfer, and this process can be repeated. The debug handler cannot simply copy the contents of the recording MSR into the breakpoint-address register. The recording MSR's hold segment offsets, while the debug registers hold virtual (linear) addresses. The debug handler must calculate the virtual address by reading the code-segment selector (CS) from the interrupt-handler stack, then reading the segment-base address from the CS descriptor, and adding that base address to the offset in the recording MSR. The calculated virtual-address can then be used as a breakpoint address.

### 13.1.6.2 Single Stepping Control Transfers

Software can enable control-transfer single stepping by setting `DebugCtl[BTF]` to 1 and `rFLAGS[TF]` to 1. The processor automatically disables control-transfer single stepping when a debug exception (`#DB`) occurs by clearing `DebugCtl[BTF]`. `rFLAGS[TF]` is also cleared when a `#DB` exception occurs. Before exiting the debug-exception handler, software must set both `DebugCtl[BTF]` and `rFLAGS[TF]` to 1 to restart single stepping.

When enabled, this single-step mechanism causes a `#DB` exception to occur on every branch instruction, interrupt, or exception. Debuggers can use this capability to perform a “coarse” single step

across blocks of code (bound by control transfers), and then, as the problem search is narrowed, switch into a “fine” single-step mode on every instruction (`DebugCtl[BTF] = 0` and `rFLAGS[TF] = 1`).

Debuggers can use both the single-step mechanism and recording mechanism to support full backward and forward tracing of control transfers.

## 13.2 Performance Monitoring Counters

The AMD64 architecture supports a set of hardware-based performance-monitoring counters (PMCs) that can be utilized to measure the frequency or duration of certain hardware events. MSRs allow the selection of events to be monitored and include a set of corresponding counter registers that accumulate a count of monitored events.

Software tools can use these counters to identify performance bottlenecks, such as sections of code that have high cache-miss rates or frequently mispredicted branches. This information can then be used as a guide for improving overall performance or eliminating performance problems through software optimizations or hardware-design improvements.

Software performance analysis tools often require a means to time-stamp an event or measure elapsed time between two events. The time-stamp counter provides this capability. See Section 13.2.4 “Time-Stamp Counter” on page 369.

The registers used in support of performance monitoring are model-specific registers (MSRs). See “Model-Specific Registers (MSRs)” on page 58 for a general discussion of MSRs and “Performance-Monitoring MSRs” on page 576 for a listing of the performance-monitoring MSR numbers and their reset values.

### 13.2.1 Performance Counter MSRs

The legacy architecture defines four performance counters (`PerfCtrn`) and corresponding event-select registers (`PerfEvtSeln`). Extensions add northbridge and L2 cache performance monitoring counters. Each `*PerfCtr` register counts events selected by the corresponding `*PerfEvtSel` register.

An architectural extension augments the number of performance and event-select registers by adding two more processor counter / event-select pairs. Further extensions add four counter / event-select pairs dedicated to counting northbridge (NB) events and four counter / event-select pairs dedicated to counting L2 cache (L2I) events.

Core logic includes instruction execution pipelines, execution units, and caches closest to the execution hardware. The NB includes logic that routes data traffic between caches, external I/O devices, and a system memory controller which reads and writes system memory (usually implemented as external DRAM). The L2 cache is a cache that is further away from the processor core than the L1 cache or caches. This cache is normally larger than the L1 cache(s) and requires more processor cycles to access. An L2 cache may be shared between physical processor cores.

All implementations support the base set of four performance counter / event-select pairs. Support for the extended performance monitoring registers and the performance-related events selectable via the \*PerfEvtSel registers vary by implementation and are described in the *BIOS and Kernel Developer's Guide* for that processor.

Core performance counters are used to count processor core events, such as data-cache misses, or the duration of events, such as the number of clocks it takes to return data from memory after a cache miss. During event counting, hardware increments a counter each time it detects an occurrence of a specified event. During duration measurement, hardware counts the number of processor clock cycles required to complete a specific hardware function.

NB performance counters are used to count events that occur within the northbridge. The L2I performance counters are used to count events associated with accessing the L2 cache.

Performance counters and event-select registers are implemented as machine-specific registers (MSRs). The base set of four PerfCtr and PerfEvtSel registers are accessed via a legacy set of MSRs and the extended set of six core PerfCtr / PerfEvtSel registers are accessed via a different set. Extended core PerfCtr / PerfEvtSel registers 0–3 alias the legacy set.

Support for the extended set of core PerfCtr registers and associated PerfEvtSel registers, as well as the sets of northbridge and L2 cache counter / event-select pairs are indicated by CPUID feature bits. See “Detecting Hardware Support for Performance Counters” on page 368. The MSR address assignments for the legacy and extended performance / event-select pairs are listed in Appendix A, Section A.6, “Performance-Monitoring MSRs” on page 576.

The length, in bits, of the performance counters is implementation-dependent, but the maximum length supported is 64 bits. Figure 13-6 shows the format of the performance counter registers.

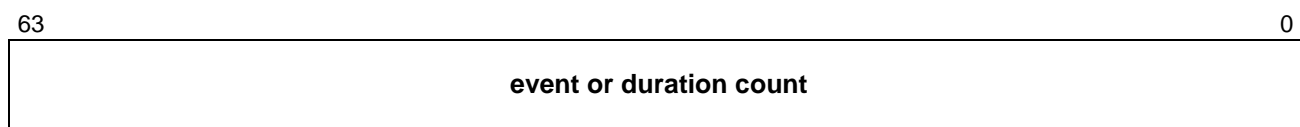

**Figure 13-6. Performance Counter Format**

For a given processor, all implemented performance counter registers can be read and written by system software running at CPL = 0 using the RDMSR and WRMSR instructions, respectively. The architecture also provides an instruction, RDPMC, which may be employed by user-mode software to read the architected core, northbridge, and L2 performance counters.

The RDPMC instruction loads the contents of the architected performance counter register specified by the index value contained in the ECX register, into the EDX register and the EAX register. The high 32 bits are returned in EDX, and the low 32 bits are returned in EAX. RDPMC can be executed only at CPL = 0, unless system software enables use of the instruction at all privilege levels. RDPMC can be enabled for use at all privilege levels by setting CR4[PCE] (the *performance-monitor counter-enable* bit) to 1. When CR4[PCE] = 0 and CPL > 0, attempts to execute RDPMC result in a general-

protection exception (#GP). For more information on the RDPMC instruction, see the instruction reference page in Volume 3 of this manual.

Writing the performance counters can be useful if software wants to count a specific number of events, and then trigger an interrupt when that count is reached. An interrupt can be triggered when a performance counter overflows (see “Counter Overflow” on page 369 for additional information). Software should use the WRMSR instruction to load the count as a two’s-complement negative number into the performance counter. This causes the counter to overflow after counting the appropriate number of times.

The performance counters are not guaranteed to produce identical measurements each time they are used to measure a particular instruction sequence, and they should not be used to take measurements of very small instruction sequences. The RDPMC instruction is not serializing, and it can be executed out-of-order with respect to other instructions around it. Even when bound by serializing instructions, the system environment at the time the instruction is executed can cause events to be counted before the counter value is loaded into EDX:EAX. The following sections describe the core performance event-select and the northbridge performance event-select registers.

### Core Performance Event-Select Registers

The core performance event-select registers (*PerfEvtSel<sub>n</sub>*) are 64-bit registers used to specify the events counted by the core performance counters, and to control other aspects of their operation. Each performance counter supported by the implementation has a corresponding event-select register that controls its operation. Figure 13-7 below shows the format of the core *PerfEvtSel* register.

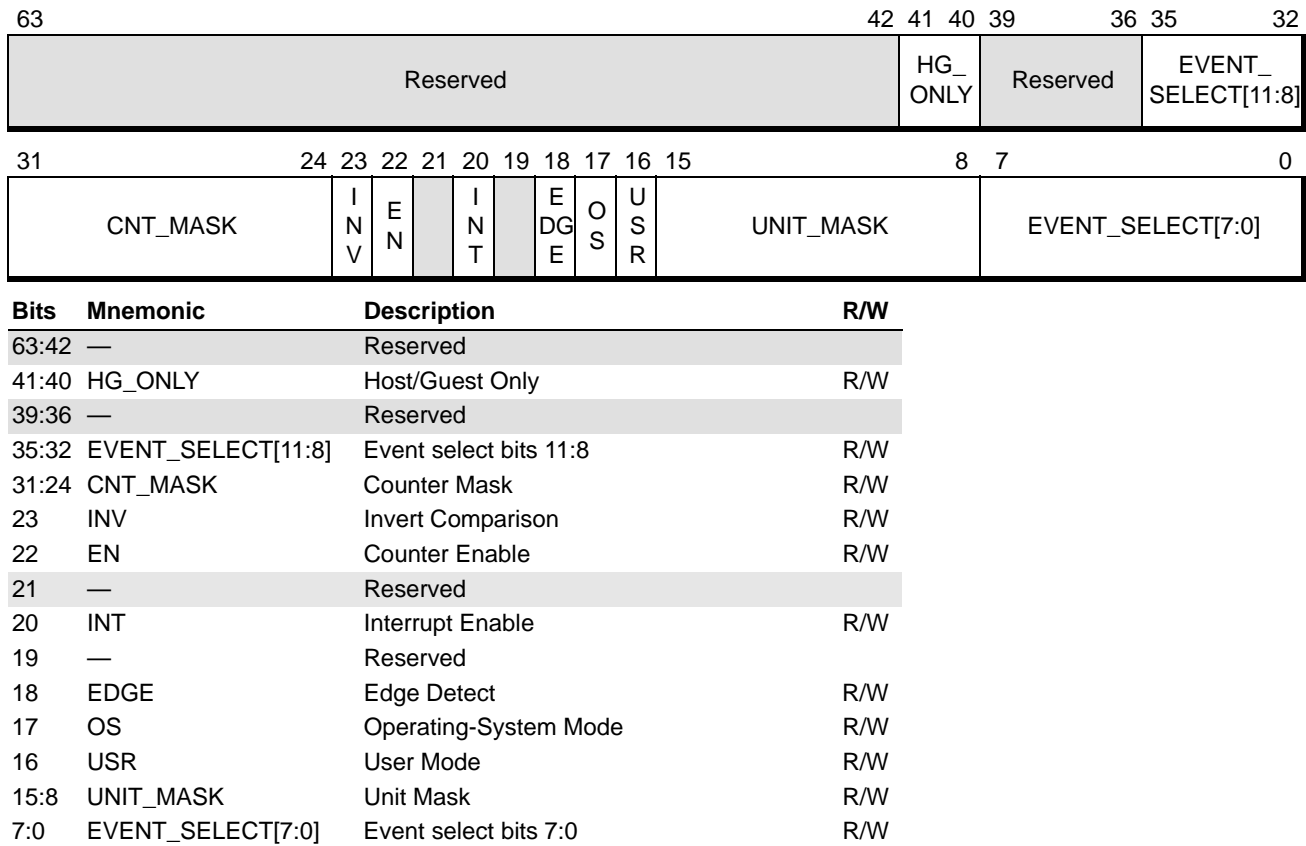

**Figure 13-7. Core Performance Event-Select Register (PerfEvtSeln)**

The fields shown in Figure 13-7 above are further described below:

- **HG\_ONLY (Host/Guest Only):** read/write. This field qualifies events to be counted based on virtualization operating mode (guest or host). The following table defines how HG\_ONLY qualifies the counting of events:

**Table 13-3. Host/Guest Only Bits**

Host Mode (Bit 41)	Guest Mode (Bit 40)	Events Counted
0	0	All events, irrespective of guest or host mode
0	1	Guest events, if EFER[SVME] = 1
1	0	Host events, if EFER[SVME] = 1
1	1	Guest and host events, if EFER[SVME] = 1

- **EVENT\_SELECT[11:8] (Event Select):** read/write. This field extends the EVENT\_SELECT field from 8 bits to 12 bits. See EVENT\_SELECT[7:0] below.

- CNT\_MASK (Counter Mask): read/write. Used with INV bit to control the counting of multiple events that occur within one clock cycle. The table below describes this:

**Table 13-4. Count Control Using CNT\_MASK and INV**

CNT_MASK	INV	Increment Value
00h	–	Corresponding PerfCtr[n] register is incremented by the number of events occurring in a clock cycle. If the number of events is equal to or greater than 32, the count register is incremented by 32.
FFh:01h <sup>1</sup>	0	Corresponding PerfCtr[n] register is incremented by 1, if the number of events occurring in a clock cycle is greater than or equal to the CNT_MASK value.
	1	Corresponding PerfCtr[n] register is incremented by 1, if the number of events occurring in a clock cycle is less than the CNT_MASK value.
Note 1: Maximum CNT_MASK value (in the range FFh:01h is implementation dependent. Consult applicable <i>BIOS and Kernel Developer's Guide</i> .		

- INV (Invert Comparison): read/write. Used with CNT\_MASK field to control the counting of multiple events within one clock cycle. See table above.
- EN (Counter Enable): read/write. Software sets this bit to 1 to enable the PerfEvtSeln register, and counting in the corresponding PerfCtrn register. Clearing this bit to 0 disables the register pair.
- INT (Interrupt Enable): read/write. Software sets this bit to 1 to enable an interrupt to occur when the performance counter overflows (see “Counter Overflow” on page 369 for additional information). Clearing this bit to 0 disables the triggering of the interrupt.
- EDGE (Edge Detect): read/write. Software sets this bit to 1 to count the number of edge transitions from the negated to asserted state. This feature is useful when coupled with event-duration monitoring, as it can be used to calculate the average time spent in an event. Clearing this bit to 0 disables edge detection.
- OS (Operating-System Mode) and USR (User Mode): read/write. Software uses these bits to control the privilege level at which event counting is performed according to Table 13-5.

**Table 13-5. Operating-System Mode and User Mode Bits**

OS (Bit 17)	USR (Bit 16)	Event Counting
0	0	No counting.
0	1	Only at CPL > 0.
1	0	Only at CPL = 0.
1	1	At all privilege levels.

- UNIT\_MASK (Unit Mask): read/write. This field further specifies or qualifies the event specified by the EVENT\_SELECT field. Depending on implementation, it may be used to specify a sub-event within the class specified by the EVENT\_SELECT field or it may act as bit mask and be used to specify a number of events within the class to be monitored simultaneously.

- EVENT\_SELECT[7:0] (Event Select [7:0]): read/write. This field concatenated with EVENT\_SELECT[11:8] specifies the event or event duration to be counted by the corresponding PerfCtr[n] register. The events that can be monitored are implementation dependent. In some implementations, support for a specific EVENT\_SELECT value may be restricted to a subset of the available performance counters. For more information, see the *BIOS and Kernel Developer's Guide* applicable to your product.

The core performance event-select registers can be read and written only by system software running at CPL = 0 using the RDMSR and WRMSR instructions, respectively. Any attempt to read or write these registers at CPL > 0 causes a general-protection exception to occur.

### Northbridge (NB) Performance Event-Select Registers

The NB performance event-select registers (NB\_PerfEvtSel<sub>n</sub>) are 64-bit registers used to specify the events counted by the northbridge performance counters, and to control other aspects of their operation. Each performance counter supported by the implementation has a corresponding event-select register that controls its operation. Figure 13-8 below shows the format of the NB\_PerfEvtSel<sub>n</sub> register.

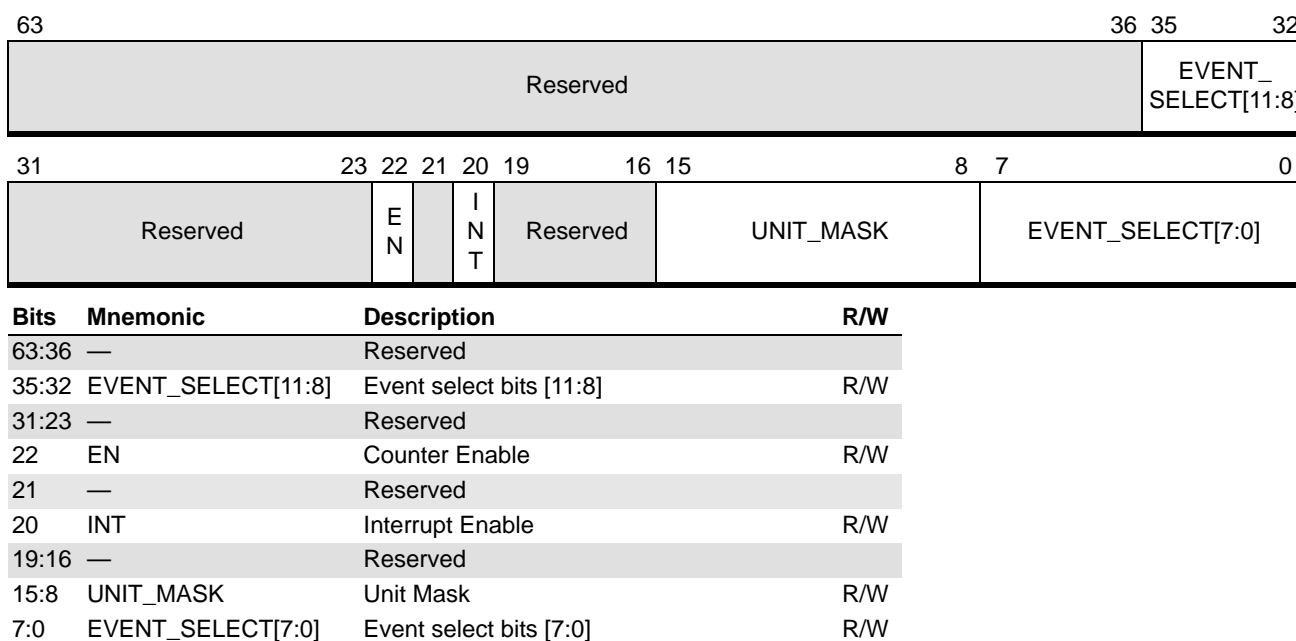

**Figure 13-8. Northbridge Performance Event-Select Register (NB\_PerfEvtSel<sub>n</sub>)**

The northbridge performance event-select registers can be read and written only by system software running at CPL = 0 using the RDMSR and WRMSR instructions, respectively. Any attempt to read or write these registers at CPL > 0 causes a general-protection exception to occur.

For more information on the defined fields within the NB\_PerfEvtSeln registers, see the *BIOS and Kernel Developer's Guide* applicable to your product.

## L2 Cache (L2I) Performance Event-Select Registers

The L2 cache performance event-select registers (L2I\_PerfEvtSeln) are 64-bit registers used to specify the events counted by the L2 cache performance counters, and to control other aspects of their operation. Each performance counter supported by the implementation has a corresponding event-select register that controls its operation. Figure 13-9 below shows the format of the L2I\_PerfEvtSeln register.

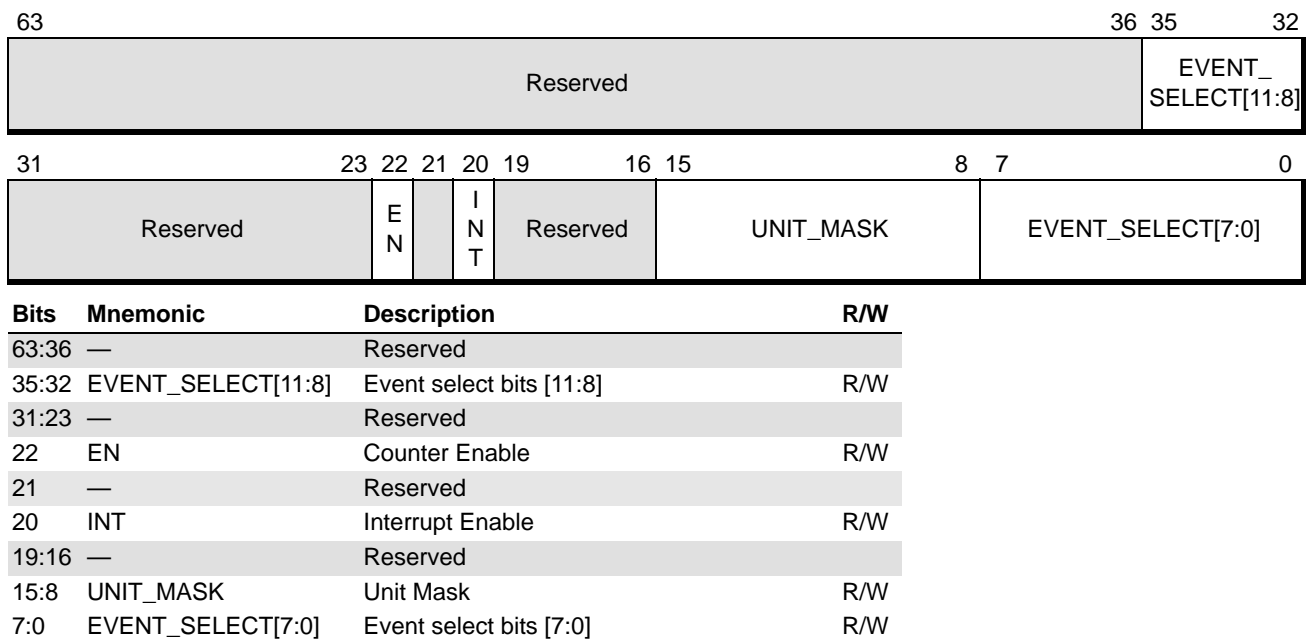

**Figure 13-9. L2 Cache Performance Event-Select Register (L2I\_PerfEvtSeln)**

The L2 cache performance event-select registers can be read and written only by system software running at CPL = 0 using the RDMSR and WRMSR instructions, respectively. Any attempt to read or write these registers at CPL > 0 causes a general-protection exception to occur.

For more information on the defined fields within the L2I\_PerfEvtSeln registers, see the *BIOS and Kernel Developer's Guide* applicable to your product.

### 13.2.2 Detecting Hardware Support for Performance Counters

Support for extended core, northbridge, and L2 cache performance counters is implementation-dependent. Support on a given processor implementation can be verified using the CPUID instruction.

CPUID Fn8000\_0001\_ECX[PerfCtrExtCore] = 1 indicates support for the six architecturally defined extended core performance counters and their associated event-select registers. CPUID



$\text{Fn8000\_0001\_ECX}[\text{PerfCtrExtNB}] = 1$  indicates support for the four architecturally defined northbridge performance counter / event-select pairs and  $\text{CPUID Fn8000\_0001\_ECX}[\text{PerfCtrExtL2I}] = 1$  indicates support for the four architecturally defined L2 cache performance counter / event-select pairs.

See Section 3.3, “Processor Feature Identification,” on page 63 for more information on using the CPUID instruction.

A given processor may implement other performance measurement MSRs with similar capabilities even if one of the optional architected facilities are not.

## 13.2.3 Using Performance Counters

### 13.2.3.1 Starting and Stopping

Performance measurement using the *PerfCtrn*, *NB\_PerfCtrn*, and *L2I\_PerfCtrn* registers is initiated by setting the corresponding *\*PerfEvtSeln[EN]* bit to 1. Counting is stopped by clearing the *\*PerfEvtSeln[EN]* bit. Software must initialize the remaining *\*PerfEvtSeln* fields with the appropriate setup information before or at the same time EN is set. Counting begins when the WRMSR instruction that sets *\*PerfEvtSeln[EN]* to 1 completes execution. Counting stops when the WRMSR instruction that clears the EN bit completes execution.

### 13.2.3.2 Counter Overflow

Some processor implementations support an interrupt-on-overflow capability that allows an interrupt to occur when one of the *\*PerfCtrn* registers overflows. The source and type of interrupt is implementation dependent. Some implementations cause a debug interrupt to occur, while others make use of the local APIC to specify the interrupt vector and trigger the interrupt when an overflow occurs. Software enables or disables the triggering of an interrupt on counter overflow by setting or clearing the *\*PerfEvtSeln[INT]* bit.

If system software makes use of the interrupt-on-overflow capability, an interrupt handler must be provided that can record information relevant to the counter overflow. Before returning from the interrupt handler, the performance counter can be re-initialized to its previous state so that another interrupt occurs when the appropriate number of events are counted.

## 13.2.4 Time-Stamp Counter

The time-stamp counter (TSC) is used to count processor-clock cycles. The TSC is cleared to 0 after a processor reset. After a reset, the TSC is incremented at a rate corresponding to the baseline frequency of the processor (which may differ from actual processor frequency in low power modes of operation). Each time the TSC is read, it returns a monotonically-larger value than the previous value read from the TSC. When the TSC contains all ones, it wraps to zero. The TSC in a 1-GHz processor counts for almost 600 years before it wraps. Figure 13-10 shows the format of the 64-bit time-stamp counter (TSC).

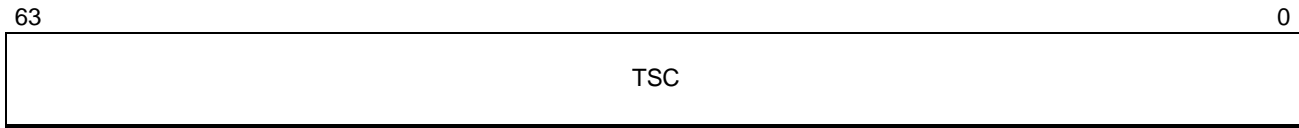

**Figure 13-10. Time-Stamp Counter (TSC)**

The TSC is a model-specific register that can also be read using one of the special *read time-stamp counter* instructions, RDTSC (Read Time-Stamp Counter) or RDTSCP (Read Time-Stamp Counter and Processor ID). The RDTSC and RDTSCP instructions load the contents of the TSC into the EDX register and the EAX register. The high 32 bits are loaded into EDX, and the low 32 bits are loaded into EAX. The RDTSC and RDTSCP instructions can be executed at any privilege level and from any processor mode. However, system software can disable the RDTSC or RDTSCP instructions for programs that run at CPL > 0 by setting CR4[TSD] (the *time-stamp disable* bit) to 1. When CR4[TSD] = 1 and CPL > 0, attempts to execute RDTSC or RDTSCP result in a general-protection exception (#GP).

The TSC register can be read and written using the RDMSR and WRMSR instructions, respectively. The programmer should use the CPUID instruction to determine whether these features are supported. If EDX bit 4 (as returned by CPUID function 1) is set, then the processor supports TSC, the RDTSC instruction and CR4[TSD]. If EDX bit 27 returned by CPUID function 8000\_0001h is set, then the processor supports the RDTSCP instruction.

The TSC register can be used by performance-analysis applications, along with the performance-monitoring registers, to help determine the relative frequency of an event or its duration. Software can also use the TSC to time software routines to help identify candidates for optimization. In general, the TSC should not be used to take very short time measurements, because the resulting measurement is not guaranteed to be identical each time it is made. The RDTSC instruction (unlike the RDTSCP instruction) is not serializing, and can be executed out-of-order with respect to other instructions around it. Even when bound by serializing instructions, the system environment at the time the instruction is executed can cause additional cycles to be counted before the TSC value is loaded into EDX:EAX.

When using the TSC to measure elapsed time, programmers must be aware that for some implementations, the rate at which the TSC is incremented varies based on the processor power management state (Pstate). For other implementations, the TSC increment rate is fixed and is not subject to power-management related changes in processor frequency. CPUID Fn 8000\_0007h\_EDX[TscInvariant] = 1 indicates that the TSC increment rate is a constant.

For more information on using the CPUID instruction to obtain processor implementation information, see Section 3.3, “Processor Feature Identification,” on page 63.

## 13.3 Instruction-Based Sampling

Instruction-Based Sampling (IBS) is a hardware facility that can be used to gather specific metrics related to processor instruction fetch and instruction execution activity. Data capture is performed by hardware at a sampling interval specified by values programmed in IBS sampling control registers. The IBS facility can be utilized by software to perform code profiling based on statistical sampling.

There are two independent data gathering components of IBS: instruction fetch sampling and instruction execution sampling. Instruction fetch sampling provides information about instruction address translation look-aside buffer (ITLB) and instruction cache behavior for a randomly selected fetch block, under the control of the IBS Fetch Control Register. Instruction execution sampling provides information about instruction execution behavior by tracking the execution of a single micro-operation (op) that is randomly selected, under the control of the IBS Execution Control Register.

When the programmed interval for fetch sampling has expired, the fetch sampling component of IBS selects and tags the next fetch block. IBS hardware records specific performance information about the tagged fetch. In a similar manner, when the programmed interval for op sampling has expired, the op sampling component of IBS selects and tags the next op being dispatched for execution.

When data collection for the tagged fetch or op is complete, the hardware signals an interrupt. An interrupt handler can then read the performance information that was captured for the fetch or op in IBS MSRs, save it, and re-enable the hardware to take the next sample.

More information about the IBS facility and how software can use it to perform code profiling can be found in the *Software Optimization Guide* for your specific product. The *Software Optimization Guide for AMD Family 15h Processors* is order #47414.

Support for the IBS feature is indicated by the CPUID Fn 8000\_0001h\_ECX[IBS]. For more information on using the CPUID instruction to obtain processor implementation information, see Section 3.3, “Processor Feature Identification,” on page 63.

### 13.3.1 IBS Fetch Sampling

When a processor fetches an instruction, it is actually reading a contiguous range of instruction bytes that contains the instruction from memory or from cache. This range of bytes loaded by the processor in one operation is called a *fetch block*. The size and address-alignment characteristics of the fetch block are implementation-dependent. In the following discussion, the term *instruction fetch* or simply *fetch* refers to this operation of reading a fetch block.

Instruction fetch sampling records the following performance information for each tagged fetch:

- If the fetch completed or was aborted
- The number of core clock cycles spent on the fetch
- If the fetch hit or missed the instruction cache
- If the instruction fetch hit or missed the instruction TLBs
- The fetch address translation page size

- The linear and physical address associated with the fetch

IBS selects and tags a fetch at a programmable rate. When enabled by the IBS Fetch Control Register (IbsFetchEn = 1 and IbsFetchVal = 0), an internal 20-bit fetch interval counter increments for every successful completion of a fetch operation. When the value in bits 19:4 of the fetch counter equal the value in the IbsFetchMaxCnt field of the IBS Fetch Control Register, the next fetch block is tagged for data collection.

When the tagged fetch completes or is aborted, the status of the fetch is written to the IBS Fetch Control Register and the associated linear address and physical address are written in the IBS Fetch Linear Address Register and IBS Fetch Physical Address Register, respectively. The IbsFetchVal bit is set in the IBS Fetch Control Register and an interrupt is generated as specified by the local APIC.

The interrupt service routine saves the performance information stored in the IBS fetch registers. Software can then initiate another sample by resetting the IbsFetchVal bit in the IBS Fetch Control Register. Hardware initializes bits 19:4 of the internal fetch interval counter with the value in the IbsFetchCnt field. If the IbsFetchCtl[IbsRandEn] bit is set, bits 3:0 of the fetch interval counter are re-initialized by hardware with a pseudo-random value; otherwise bits 3:0 are cleared.

### 13.3.2 IBS Fetch Sampling Registers

The IBS fetch sampling registers consist of the status and control register (IBS Fetch Control Register) and the associated fetch address registers (IBS Fetch Linear Address Register and IBS Fetch Physical Address Register). The IBS fetch sampling registers are accessed using the RDMSR and WRMSR instructions.

#### IBS Fetch Control Register

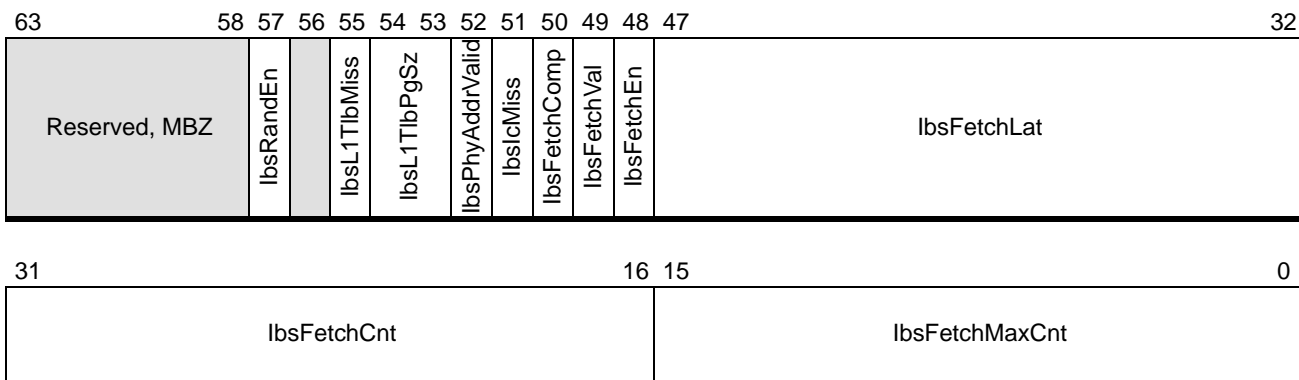

Bit(s)	Field Mnemonic	Descriptive Name	R/W
63:58	—	Reserved, MBZ	
57	IbsRandEn	IBS Randomize Tagging Enable	R/W
56	—	Reserved	
55	IbsL1TlbMiss	IBS Fetch L1 TLB Miss	R/W
54:53	IbsL1TlbPgSz	IBS Fetch L1 TLB Page Size	R/W
52	IbsPhyAddrValid	IBS Fetch Physical Address Valid	R/W
51	IbsIcMiss	IBS Instruction Cache Miss	R/W
50	IbsFetchComp	IBS Fetch Complete	R/W
49	IbsFetchVal	IBS Fetch Valid	R/W
48	IbsFetchEn	IBS Fetch Enable	R/W
47:32	IbsFetchLat	IBS Fetch Latency	R/W
31:16	IbsFetchCnt	IBS Fetch Count	R/W
15:0	IbsFetchMaxCnt	IBS Fetch Maximum Count	R/W

**Figure 13-11. IBS Fetch Control Register(IbsFetchCtl)**

The fields shown in Figure 13-11 are further described below:

- **IbsRandEn** (IBS Randomize Tagging Enable)—Bit 57, read/write. Software sets this bit to 1 to add variability to the interval at which fetch operations are selected for tagging. When set, bits 3:0 of the fetch interval counter are set to a pseudo-random value when the IbsFetchCtl register is written. Clearing this bit causes bits 3:0 of the fetch interval counter to be reset to zero.
- **IbsL1TlbMiss** (IBS Fetch L1 TLB Miss)—Bit 55, read/write. This bit is set if the tagged fetch missed in the L1 TLB.
- **IbsL1TlbPgSz[1:0]** (IBS Fetch L1 TLB Page Size)—Bits 54:53, read/write. This field indicates the page size of the translation in the L1 TLB for the tagged fetch. This field is valid only if **IbsPhyAddrVal** = 1. The table below defines the encoding of this two-bit field:

Value	Page Size
00b	4 Kbyte
01b	2 Mbyte
10b	1 Gbyte
11b	Reserved

Some implementations might not support all page sizes. Note: The page size in the L1 TLB might not match the page size in the page table.

- **IbsPhyAddrValid** (IBS Fetch Physical Address Valid)—Bit 52, read/write. This bit is set if the physical address of the tagged fetch is valid. When this bit is set, the **IbsL1TlbPgSz** field and the contents of the IBS Fetch Physical Address Register (see definition of this register below) are both valid.
- **IbsIcMiss** (IBS Instruction Cache Miss)—Bit 51, read/write. This bit is set if the tagged fetch missed in the instruction cache.

- IbsFetchComp (IBS Fetch Complete)—Bit 50, read/write. This bit is set if the tagged fetch completes and data is available for use by the instruction decoder.
- IbsFetchVal (IBS Fetch Valid)—Bit 49, read/write. This bit is set if the tagged fetch either completes or is aborted. When the bit is set, captured data for the tagged fetch is available and the fetch interval counter stops. An interrupt is generated as specified by the local APIC. The interrupt handler should read and save the captured performance data before clearing the bit.
- IbsFetchEn (IBS Fetch Enable)—Bit 48, read/write. Software sets this bit to enable fetch sampling. Clearing this bit to 0 disables fetch sampling.
- IbsFetchLat[15:0] (IBS Fetch Latency)—Bits 47:32, read/write. This 16-bit field indicates the number of core clock cycles from the initiation of the fetch to the delivery of the instruction bytes to the core. If the fetch is aborted before it completes, this field returns the number of clock cycles from the initiation of the fetch to its abortion.
- IbsFetchCnt[15:0] (IBS Fetch Count)—Bits 31:16, read/write. This 16-bit field returns the current value of bits 19:4 of the fetch interval counter on a read. Bits 19:4 of the fetch interval counter are set to this value on a write.
- IbsFetchMaxCnt[15:0] (IBS Fetch Maximum Count)—Bits 15:0, read/write. This 16-bit field specifies the maximum count value of bits 19:4 of the fetch interval counter. When the value in bits 19:4 of the fetch counter equals the value in this field, the next fetch block is tagged for profiling.

**IBS Fetch Linear Address Register**



Bit(s)	Field Mnemonic	Descriptive Name	R/W
63:0	IbsFetchLinAd	IBS Fetch Linear Address	RO

**Figure 13-12. IBS Fetch Linear Address Register (IbsFetchLinAd)**

This is a read-only register. Reading the IbsFetchLinAd MSR returns the 64-bit linear address of the tagged fetch. This address may correspond to the first byte of an AMD64 instruction or the start of the fetch block. The address is valid only if the IbsFetchVal bit is set. The address is in canonical form.

## IBS Fetch Physical Address Register



Bit(s)	Field Mnemonic	Descriptive Name	R/W
63:52	—	Reserved, MBZ	n/a
51:0	IbsFetchPhysAd	IBS Fetch Physical Address	RO

**Figure 13-13. IBS Fetch Physical Address Register (IbsFetchPhysAd)**

This is a read-only register. Reading the IbsFetchPhysAd MSR returns the 52-bit physical address of the tagged fetch. This address may correspond to the first byte of an AMD64 instruction or the start of the fetch block. The address is valid only if both the IbsPhyAddrValid and the IbsFetchVal bits of the IbsFetchCtl register are set. Otherwise, the contents of this register are undefined. The indicated size of 52 bits is an architectural limit. Specific processors may implement fewer bits.

### 13.3.3 IBS Execution Sampling

Instruction execution performance is measured by tagging an op associated with an instruction. The tagged op joins other ops in a queue waiting to be dispatched and executed. Instructions that decode to more than one op may return different performance data depending upon which op associated with the instruction is tagged. IBS returns the following performance information for each retired tagged op:

- Branch status for branch ops.
- For a load or store op:
  - Whether the load or store missed in the data cache.
  - Whether the load or store address hit or missed in the TLBs.
  - The linear and physical address of the data operand associated with the load or store operation.
  - Source information for cache, DRAM, MMIO, or I/O accesses.

IBS selects and tags an op at a programmable rate. When enabled by the IBS Execution Control Register (IbsOpEn = 1 and IbsOpVal = 0), an internal 27-bit op interval counter increments either once for every core clock cycle, if IbsOpCntCtl is cleared, or once for every dispatched op, if IbsOpCntCtl is set.

When the value in bits 26:4 of the op counter equals the value in the IbsOpMaxCnt field of the IBS Execution Control Register, an op is tagged in the next cycle. When the op is retired, the execution status of the op is written to the IBS execution registers, and IbsOpVal bit of the IBS Execution Control

Register is set. When this is complete, an interrupt is signalled to the local APIC. The local APIC should be programmed to deliver this interrupt to the processor core.

The interrupt service routine must save the performance information stored in IBS execution registers. Software can then initiate another sample by resetting the IbsOpVal bit in the IBS Execution Control Register.

Aborted ops do not produce an IBS execution sample. If the tagged op aborts (i.e., does not retire), hardware resets bits 26:7 of the op interval counter to zero, and bits 6:0 to a random value. The op counter continues to increment and another op is selected when the value in bits 26:4 of the op interval counter equals the value in the IbsOpMaxCnt field.

**Randomization of sampling interval:** A degree of randomization of the sampling interval is necessary to ensure fairness in sampling, especially for loop-intensive code. For execution sampling this must be done by software. This is accomplished when writing the IbsOpCtl register to clear the IbsOpVal bit and initiate a new sampling interval. At that time software can provide a small random number (4-6 bits) in the IbsOpCurCnt field to offset the starting count, thereby randomizing the point at which the count reaches the IbsOpMaxCnt value and triggers a sample.

### 13.3.4 IBS Execution Sampling Registers

The IBS execution sampling registers consist of the control register (IBS Execution Control Register), the linear address register (IBS Op Linear Address Register), and three execution data registers (IBS Op Data 1–3). The IBS execution sampling registers are accessed using the RDMSR and WRMSR instructions.

#### IBS Execution Control Register (IbsOpCtl)

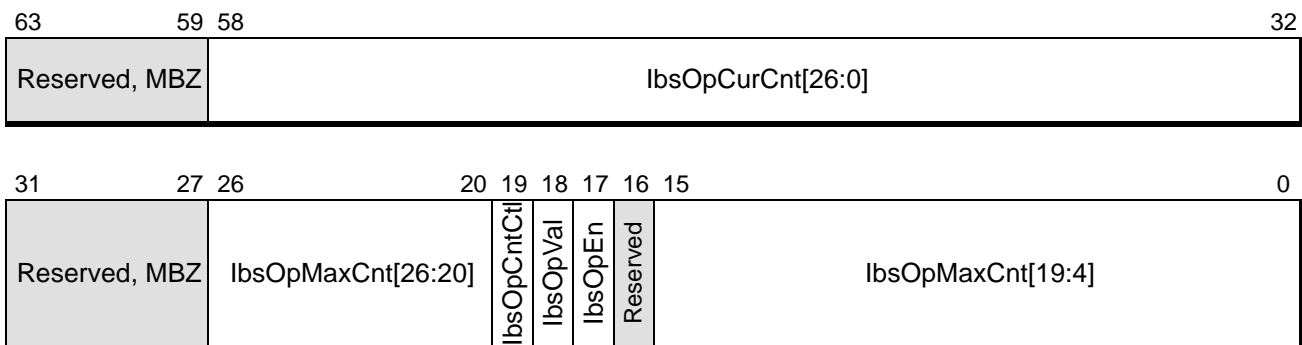



Bit(s)	Field Mnemonic	Descriptive Name	R/W
63:59	—	Reserved, MBZ	
58:32	IbsOpCurCnt[26:0]	IBS Op Current Count, bits 26:0	R/W
31:27	—	Reserved, MBZ	
26:20	IbsOpMaxCnt[26:20]	IBS Op Maximum Count, bits 26:20	R/W
19	IbsOpCntCtl	IBS Op Counter Control	R/W
18	IbsOpVal	IBS Op Sample Valid	R/W
17	IbsOpEn	IBS Op Sampling Enable	R/W
16	—	Reserved, MBZ	
15:0	IbsOpMaxCnt[19:4]	IBS Op Maximum Count, bits 19:4	R/W

**Figure 13-14. IBS Execution Control Register (IbsOpCtl)**

The fields shown in Figure 13-14 are further described below:

- **IbsOpCurCnt[26:0]** (IBS Op Current Count)—Bits 58:32, read/write. This field returns the current value of the op counter, and provides the starting value of the counter when software writes this register to clear the IbsOpVal bit and start another sampling interval.
- **IbsOpMaxCnt[26:20]** (IBS Op Maximum Count[26:20])—Bits 26:20, read/write. This field is used to specify the most significant 7 bits of the IbsOpMaxCnt.
- **IbsOpCntCtl** (IBS Op Counter Control)—Bit 19, read/write. This bit controls op tagging. When this bit is zero, IBS counts core clock cycles in order to select an op for tagging. When this bit is one, IBS counts dispatched ops in order to select an op for tagging.
- **IbsOpVal** (IBS Op Sample Valid)—Bit 18, read/write. This bit is set when a tagged op retires and indicates that new instruction execution data is available. The op counter stops counting. An interrupt is generated as specified by the local APIC. The software interrupt handler captures the performance data before clearing the bit to enable the hardware to take another sample.
- **IbsOpEn** (IBS Op Sample Enable)—Bit read/write. Software sets this bit to enable IBS execution sampling. Clearing this bit disables IBS execution sampling.
- **IbsOpMaxCnt[19:4]** (IBS Op Maximum Count[19:4]): read/write. This field specifies the maximum count value for bits 19:4 of the op interval counter. When the value in bits 26:4 of the op interval counter equal the value specified by the concatenation of the IbsOpMaxCnt[26:20] field with this field, the next op is tagged for profiling.

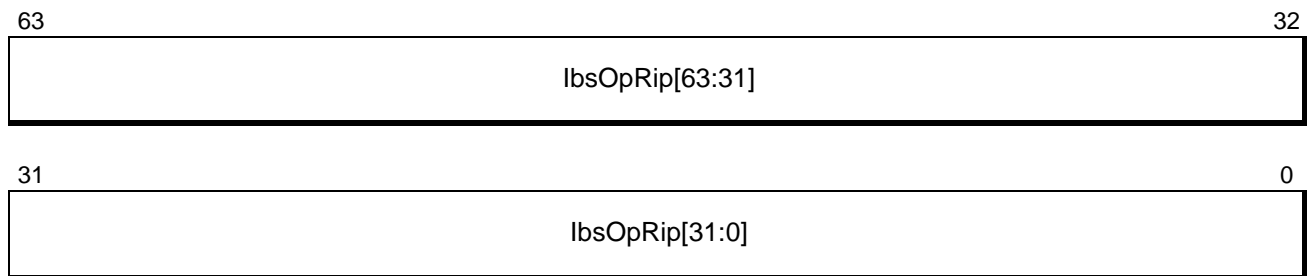
**IBS Op Linear Address Register (IbsOpRip)**

Bit(s)	Field Mnemonic	Descriptive Name	R/W
63:0	IbsOpRip	IBS Op Linear Address	R/W

**Figure 13-15. IBS Op Linear Address Register (IbsOpRip)**

IbsOpRip[63:0] (IBS Op Linear Address): read/write. Specifies the linear address for the instruction from which the tagged op was issued. The address is valid only if the IbsOpCtl[IbsOpVal] bit is set and the IbsOpData1[IbsRipInvalid] bit is cleared. The address is in canonical form.

## IBS Op Data 1 Register (IbsOpData1)

The IBS Op Data 1 Register provides core cycle counts for tagged ops and performance data for tagged ops which perform a branch.

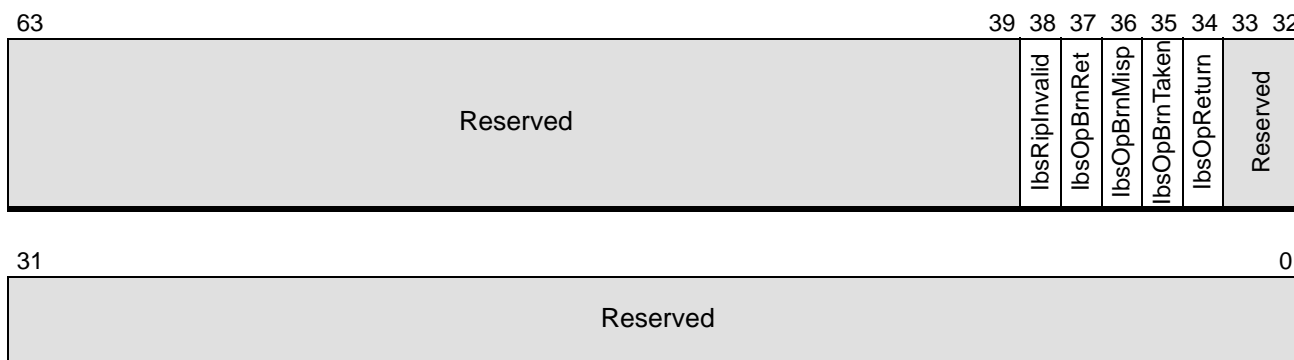

Bit(s)	Field Mnemonic	Descriptive Name	R/W
63:39	—	Reserved	
38	IbsRipInvalid	IbsOpRip Register Invalid	R/W
37	IbsOpBrnRet	IBS Op Branch Retired	R/W
36	IbsOpBrnMisp	IBS Op Branch Mispredicted	R/W
35	IbsOpBrnTaken	IBS Op Branch Taken	R/W
34	IbsOpReturn	IBS Op RET	R/W
33:0	—	Reserved	

**Figure 13-16. IBS Op Data 1 Register (IbsOpData1)**

The fields shown in Figure 13-16 are further described below:

- **IbsRipInvalid (IbsOpRip Register Invalid)**—Bit 38, read/write. If this bit is set, the contents of the IbsOpRip register are not valid.
- **IbsOpBrnRet (IBS Op Branch Retired)**—Bit 37, read/write. This bit is set if the tagged op performs a branch that retired.
- **IbsOpBrnMisp (IBS Op Branch Mispredicted)**—Bit 36, read/write. This bit is set if the tagged op performs a retired mispredicted branch.
- **IbsOpBrnTaken (IBS Op Branch Taken)**—Bit 35, read/write. This bit is set if the tagged op performs a retired taken branch.
- **IbsOpReturn (IBS Op RET)**—Bit 34, read/write. This bit is set if the tagged op performs a retired subroutine return (RET).

**IBS Op Data 2 Register (IbsOpData2)**

The IBS Op Data 2 Register captures northbridge-related performance data. The information captured is implementation-dependent. See the *BIOS and Kernel Developer's Guide* applicable to your product for details.

### IBS Op Data 3 Register (IbsOpData3)

Data Cache (first-level cache) performance data is captured in IBS Op Data 3 Register. If a load or store operation crosses a 128-bit boundary, the data returned in this register is the data for the access to the data below the 128-bit boundary.

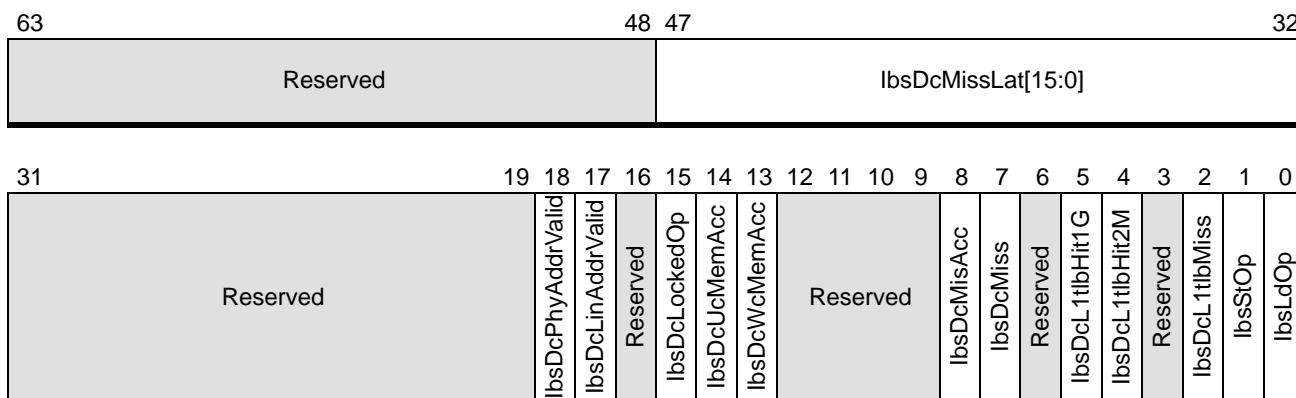

Bit(s)	Field Mnemonic	Descriptive Name	R/W
63:48	—	Reserved	
47:32	IbsDcMissLat[15:0]	IBS Data Cache Miss Latency	R/W
31:19	—	Reserved	
18	IbsDcPhyAddrValid	IBS Data Cache Physical Address Valid	R/W
17	IbsDcLinAddrValid	IBS Data Cache Linear Address Valid	R/W
16	—	Reserved	
15	IbsDcLockedOp	IBS Data Cache Locked Op	R/W
14	IbsDcUcMemAcc	IBS Data Cache UC Memory Access	R/W
13	IbsDcWcMemAcc	IBS Data Cache WC Memory Access	R/W
12:9	—	Reserved	
8	IbsDcMisAcc	IBS Data Cache Misaligned Access Penalty	R/W
7	IbsDcMiss	IBS Data Cache Miss	R/W
6	—	Reserved	
5	IbsDcL1tlbHit1G	IBS Data Cache L1 TLB Hit 1-Gbyte Page	R/W
4	IbsDcL1tlbHit2M	IBS Data Cache L1 TLB Hit 2-Mbyte Page	R/W
3	—	Reserved	
2	IbsDcL1tlbMiss	IBS Data Cache L1 TLB Miss	R/W
1	IbsStOp	IBS Store Operation	R/W
0	IbsLdOp	IBS Load Operation	R/W

**Figure 13-17. IBS Op Data 3 Register (IbsOpData3)**

The fields shown in Figure 13-17 are further described below:

- **IbsDcMissLat[15:0]** (IBS Data Cache Miss Latency)—Bits 47:32, read/write. This field indicates the number of core clock cycles from when a miss is detected in the data cache to when the data is delivered to the core. The value is not valid for data cache store operations.
- **IbsDcPhyAddrValid** (IBS Data Cache Physical Address Valid)—Bit 18, read/write. This bit is set if the physical address in the IBS DC Physical Address Register is valid for a load or store operation.
- **IbsDcLinAddrValid** (IBS Data Cache Linear Address Valid )—Bit 17, read/write. This bit is set if the linear address in the IBS DC Linear Address Register is valid for a load or store operation.
- **IbsDcLockedOp** (IBS Data Cache Locked Op)—Bit 15, read/write. This bit is set if the tagged load or store operation was a locked operation.
- **IbsDcUcMemAcc** (IBS Data Cache UC Memory Access)—Bit 14, read/write. This bit is set if the tagged load or store operation accessed uncacheable memory.
- **IbsDcWcMemAcc** (IBS Data Cache WC Memory Access)—Bit 13, read/write. This bit is set if the tagged load or store operation accessed write combining memory.
- **IbsDcMisAcc** (IBS Data Cache Misaligned Access Penalty)—Bit 8, read/write. This bit is set if a tagged load or store operation incurred a performance penalty due to a misaligned access.
- **IbsDcMiss** (IBS Data Cache Miss)—Bit 7, read/write. This bit is set if the cache line used by the tagged load or store operation was not present in the data cache.
- **IbsDcL1tlbHit1G** (IBS Data Cache L1 TLB Hit 1-Gbyte Page)—Bit 5, read/write. This bit is set if the physical address for the tagged load or store operation was present in a 1-Gbyte page table entry in the data cache L1 TLB.
- **IbsDcL1tlbHit2M** (IBS Data Cache L1 TLB Hit 2-Mbyte Page)—Bit 4, read/write. This bit is set if the physical address for the tagged load or store operation was present in a 2-Mbyte page table entry in the data cache L1 TLB.
- **IbsDcL1tlbMiss** (IBS Data Cache L1 TLB Miss)—Bit 2, read/write. This bit is set if the physical address for the tagged load or store operation was not present in the data cache L1 TLB.
- **IbsStOp** (IBS Store Op)—Bit 1, read/write. This bit is set if the tagged op was a store.
- **IbsLdOp** (IBS Load Op)—Bit 0, read/write. This bit is set if the tagged op was a load.

### IBS Data Cache Linear Address Register (**IbsDcLinAd**)

63

32

IbsDcLinAd[63:32]
-------------------

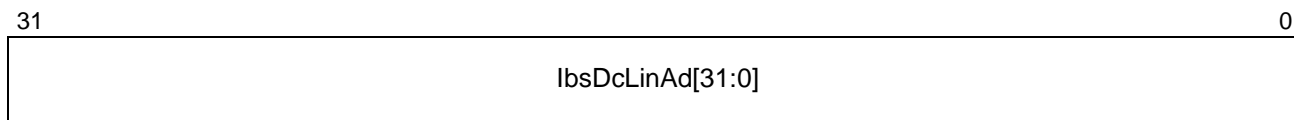

Bit(s)	Field Mnemonic	Descriptive Name	R/W
63:0	IbsDcLinAd	IBS Data Cache Linear Address	R/W

**Figure 13-18. IBS Data Cache Linear Address Register (IbsDcLinAd)**

IbsDcLinAd[63:0] (IBS Data Cache Linear Address): read/write. Specifies the linear address of the tagged op's memory operand. The address is valid only if IbsOpData3[IbsDcLinAdVal] is set. The address is in canonical form.

### IBS Data Cache Physical Address Register (IbsDcPhysAd)

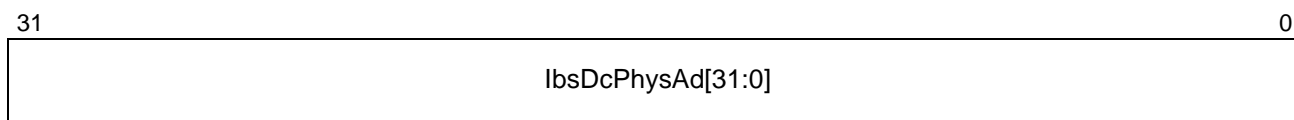
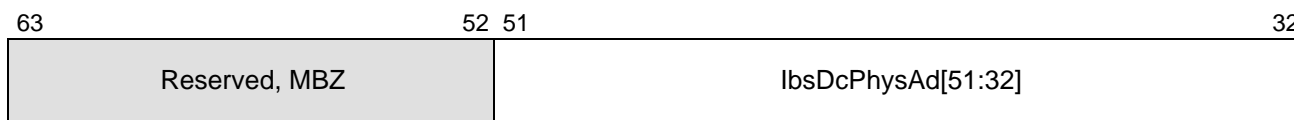

Bit(s)	Field Mnemonic	Descriptive Name	R/W
63:52	—	Reserved, MBZ	
51:0	IbsDcPhysAd	IBS Data Cache Physical Address	R/W

**Figure 13-19. IBS Data Cache Physical Address Register (IbsDcPhysAd)**

IbsDcPhysAd (IBS Data Cache Physical Address): read/write. Specifies the physical address of the tagged op's memory operand. The address is valid only if IbsOpData3[IbsDcPhyAdVal] is set.

### IBS Branch Target Address Register (IbsBrTarget)

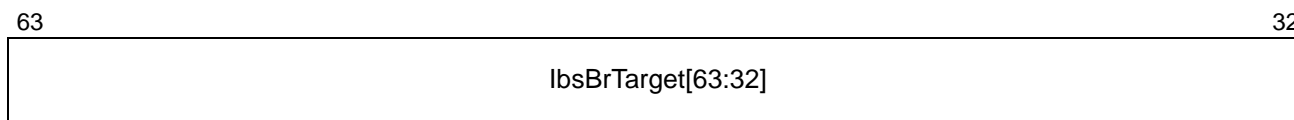

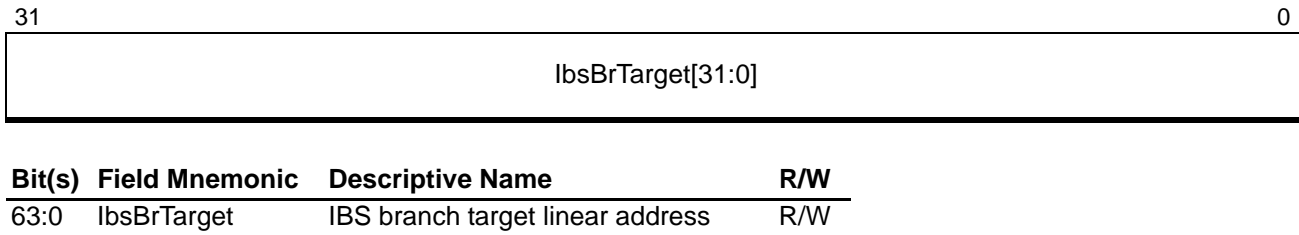

**Figure 13-20. IBS Branch Target Address Register (lbsBrTarget)**

lbsBrTarget (IBS Branch Target): read/write. Specifies the 64-bit linear address for the branch target. The address is in canonical form. The branch target address is valid if it is non-zero. For a conditional branch not taken, the value supplied in this register is the fall-through address.

## 13.4 Lightweight Profiling

Lightweight Profiling (LWP) is an AMD64 extension that allows user mode processes to gather performance data about themselves with very low overhead. LWP is supported in both long mode and legacy mode. Modules such as managed runtime environments and dynamic optimizers can use LWP to monitor the running program with high accuracy and high resolution. They can quickly discover performance problems and opportunities and immediately act on this information.

LWP allows a program to gather performance data and examine it either by polling or by taking an occasional interrupt. It introduces minimal additional state to the CPU and the process. LWP differs from the existing performance counters and from Instruction Based Sampling (IBS) because it collects large quantities of data before taking an interrupt. This substantially reduces the overhead of using performance feedback. An application can avoid the need to enable and process interrupts by polling the LWP data.

A program can control LWP data collection entirely in user mode. It can start, stop, and reconfigure profiling without calling the kernel.

LWP runs within the context of a thread, so it can be used by multiple processes in a system at the same time without interference. This also means that if one thread is using LWP and another is not, the latter thread incurs no profiling overhead.

LWP can be programmed to run in one of two modes: *synchronized mode* or *continuous mode*. In synchronized mode the recording of events stops when the buffer set up to hold event records becomes full. In continuous mode, the storing of events wraps in the buffer overwriting older records.

### 13.4.1 Overview

When enabled, LWP hardware monitors one or more events during the execution of user-mode code and periodically inserts event records into a ring buffer in the address space of the running process. If performance timestamping is supported and enabled, each event record captured is timestamped using



the value read from the performance timestamp counter (PTSC). Timestamping is enabled by setting the `Flags.PTSC` bit of the Lightweight Profiling Control Block (LWPCB). When the ring buffer is filled beyond a user-specified threshold, the hardware can cause an interrupt which the operating system (OS) uses to signal a process to empty the ring buffer. With proper OS support, the interrupt can even be delivered to a separate process or thread.

LWP only counts instructions that retire in user mode ( $CPL = 3$ ). Instructions that change to  $CPL = 3$  from some other level are not counted, since the instruction address is not an address in user mode space. LWP does not count hardware events while the processor is in system management mode (SMM) and while entering or leaving SMM.

Once LWP is enabled, each user-mode thread uses the `LLWPCB` and `SLWPCB` instructions to control LWP operation. These instructions refer to a data structure in application memory called the Lightweight Profiling Control Block, or LWPCB, to specify the profiling parameters and to interact with the LWP hardware. The LWPCB in turn points to a buffer in memory in which LWP stores event records.

Each thread in a multi-threaded process must configure LWP separately. A thread has its own ring buffer and counters which are context switched with the rest of the thread state. However, a single monitor thread could collect and process LWP data from multiple other threads.

LWP may be set up to run in one of two modes:

- Synchronized Mode

LWP runs in synchronized mode when it is started with `LWPCB.Flags.CONT = 0`. In this mode, LWP will not advance the ring buffer pointer when the event ring buffer is full. It simply increments `LWPCB.MissedEvents` to count the number of missed event records. In synchronized mode, a thread can remove event records from the ring buffer by advancing the ring buffer tail pointer without stopping LWP in the executing thread. If the buffer had been full, event records will again be written and the ring buffer pointer will be advanced.

- Continuous Mode

LWP runs in continuous mode when it is started with `LWPCB.Flags.CONT = 1`. In this mode, LWP will store an event record even when the event ring buffer is full, wrapping around in the ring buffer and overwriting the oldest event record. In continuous mode, `LWPCB.MissedEvents` counts the number of times that such wrapping has occurred. The only reliable way to read events from the ring buffer when LWP is in continuous mode is to stop LWP in the running thread before accessing the LWPCB and the ring buffer contents. Support for continuous mode is indicated by `CPUID Fn8000_001C_EAX[LwpCont]`.

During profiling, the LWP hardware monitors and reports on one or more types of events. Following are the steps in this process:

1. **Count**—Each time an instruction is retired, LWP decrements its internal event counters for all of the events associated with the instruction. An instruction can cause zero, one, or multiple events. For instance, an indirect jump through a pointer in memory counts as an instruction retired, a branch retired, and may also cause up to two DCache misses (or more, if there is a TLB miss) and up to two ICache misses.
  - Some events may have filters or conditions on them that regulate counting. For instance, the application may configure LWP so that only cache miss events with latency greater than a specified minimum are eligible to be counted.

2. **Gather**—When an event counter becomes negative, the event should be reported. LWP gathers an event record and, if enabled, samples the value in the PTSC to be included in the record as the TimeStamp value. The event's counter may continue to count below zero until the record is written to the event ring buffer.

For most events, such as instructions retired, LWP gathers an event record describing the instruction that caused the counter to become negative. However, it is valid for LWP to gather event record data for the *next* instruction that causes the event, or to take other measures to capture a record. Some of these options are described with the individual events.

- An implementation can choose to gather event information on one or many events at any one time. If multiple event counters become negative, an advanced LWP implementation might gather one event record per event and write them sequentially. A basic LWP implementation may choose one of the eligible events. Other events continue counting but wait until the first event record is written. LWP picks the next eligible instructions for the waiting events. This situation should be extremely uncommon if software chooses large event interval values.
  - LWP may discard an event occurrence. For instance, if the LWPCB or the event ring buffer needs to be paged in from disk, LWP might choose not to preserve the pending event data. If an event is discarded, LWP gathers an event record for the next instruction to cause the event.
  - Similarly, if LWP needs to replay an instruction to gather a complete event record, the replay may abort instead of retiring. The event counter continues counting below zero and LWP gathers an event record for the next instruction to cause the event.
3. **Store**—When a complete event record is gathered, LWP stores it into the event ring buffer in the process' address space and advances the ring buffer head pointer.
    - LWP checks to see if the ring buffer is full, i.e., if advancing the ring buffer head pointer would make it equal to the tail pointer. If the buffer is full, LWP increments the 64-bit counter LWPCB.MissedEvents. If LWP is running in synchronized mode, it does not advance the head pointer. If LWP is running in continuous mode, it always advances the head pointer and LWPCB.MissedEvents counts the number of times that the buffer wrapped.
    - If more than one event record reaches the Store stage simultaneously, only one need be stored. Though LWP might store all such event records, it may delay storing some event records or it may discard the information and proceed to choose the next eligible instruction for the discarded event type(s). This behavior is implementation dependent.
    - The store need not complete synchronously with the instruction retiring. In other words, if LWP buffers the event record contents, the Store stage (and subsequent stages) may complete

some number of cycles after the tagged instruction retires. The data about the event and the instruction are precise, but the Report and Reset steps (below) may complete later.

4. **Report**—If LWP threshold interrupts are enabled and the space used in the event ring buffer exceeds a user-defined threshold, LWP initiates an interrupt. The OS can use this to signal the process to empty the ring buffer. Note that the interrupt may occur significantly later than the event that caused the threshold to be reached.
5. **Reset**—For each event that was stored, the counter is reset to its programmed interval. If requested by the application, LWP applies randomization to the low order bits of the interval. Counting for that event continues. Reset happens if the ring buffer head pointer was advanced or if the missed event counter was incremented. If the event counter went below -1, indicating that additional events occurred between the selected event and the time it was reported, that overrun value reduces the reset value so as to preserve the statistical distribution of events.

For all events except the LWPVAL instruction, the hardware may impose a minimum on the reset value of an event counter. This prevents the system from spending too much time storing samples rather than making forward progress on the application. Any minimum imposed by the hardware can be detected by examining the `EventInterval $n$`  fields in the LWPCB after enabling LWP.

An application should periodically remove event records from the ring buffer and advance the tail pointer. (If the application does not process the event records quickly enough or often enough, the LWP hardware will detect that the ring buffer is full and will miss events.) There are two ways to process the gathered events: interrupts or polling.

The application can wait until a threshold interrupt occurs to process the event records in the ring buffer. This requires OS or driver support. (As a consequence, interrupts can only be enabled if a kernel mode routine allows it; see “LWP\_CFG—LWP Configuration MSR” on page 402) One usage model is to associate the LWP interrupt with a semaphore or mutex. When the interrupt occurs, the OS or driver signals the associated object. A thread waiting on the object wakes up and empties the ring buffer. Other models are possible, of course.

Alternatively, the application can have a thread that periodically polls the ring buffer. The polling thread need not be part of the process that is using LWP. It can be in a separate process that shares the memory containing the LWP control block and ring buffer.

Access to the ring buffer uses a lockless protocol between the LWP hardware and the application. The hardware owns the head pointer and the area in the ring buffer from the head pointer up to (but not including) the tail pointer. The application must not modify the head pointer nor rely on any data in the area of the ring buffer owned by the hardware. If the application has a stale value for the head pointer, it may miss an existing event record but it will never read invalid data. When the application is done emptying the ring buffer, it should refresh its copy of the head pointer to see if the LWP hardware has added any new event records.

Similarly, the application owns the tail pointer and the area in the ring buffer from the tail pointer up to (but not including) the head pointer. The hardware will never modify the tail pointer or overwrite the data in that region of the ring buffer. If the hardware has a stale value for the tail pointer, it may

consider that the ring buffer is full or at its threshold, but it will never overwrite valid data. Instead, it refreshes its copy of the tail pointer and rechecks to see if the full or threshold condition still applies.

When LWP is in continuous mode, this lockless protocol does not work, since the LWP hardware may overwrite the event records in the ring buffer when it advances the head pointer past the tail pointer. Because of this, the application must stop LWP before removing event records from the ring buffer. This prevents the hardware from wrapping through the ring buffer asynchronously from the application's attempt to remove data from it.

To use continuous mode properly, the application should set `LWPCB.MissedEvents` to 0 and set the head and tail pointers to the start of the ring buffer before starting LWP. To empty the ring buffer, the application should stop LWP. If `LWPCB.MissedEvents` is 0, the buffer did not wrap and there are event records starting at the tail pointer and continuing up to (but not including) the head pointer. If `MissedEvents` is not 0, the buffer wrapped and there are event records starting with the oldest one pointed to by the head pointer and continuing (possibly wrapping) all the way around to the newest one just before the head pointer.

### 13.4.2 Events and Event Records

When a monitored event overflows its event counter, LWP puts an event record into the LWP event ring buffer. If event timestamping is supported and enabled, each event record will include a `TimeStamp` value. This value is a copy of the contents of Performance Timestamp Counter (PTSC) zero-extended if necessary to 64 bits.

The PTSC is a free-running counter that increments at a constant rate of 100MHz and is synchronized across all cores on a node to within +/-1. This counter starts when the processor is initialized and cannot be reset or modified. It is at least 40 bits wide. Privileged code can read the PTSC value via the RDMSR instruction. The size of the counter is indicated by the 2-bit field `CPUID Fn8000_0008_ECX[PerfTscSize]`. A value of 00b means that the PTSC is 40 bits wide; 01b means 48 bits, 10b means 56 bits, and 11b indicates a full 64 bits.

The PTSC can be correlated to the architectural TSC that runs at the P0 frequency. An application can read the TSC and PTSC, wait a 1000 clock periods or so, then read them again. The ratio of the differences is the scaling factor for the counters.

The event record size is fixed but may vary based on implementation. The event record size for a given processor is discovered by executing `CPUID Fn8000_001C` and extracting the value of the `LwpEventSize` field. (See “Detecting LWP Capabilities” on page 399). Current implementations fix the record size at 32 bytes and this size is used in the record format specifications below.

Reserved fields and fields that are not defined for a particular event are set to zero when LWP writes an event record.

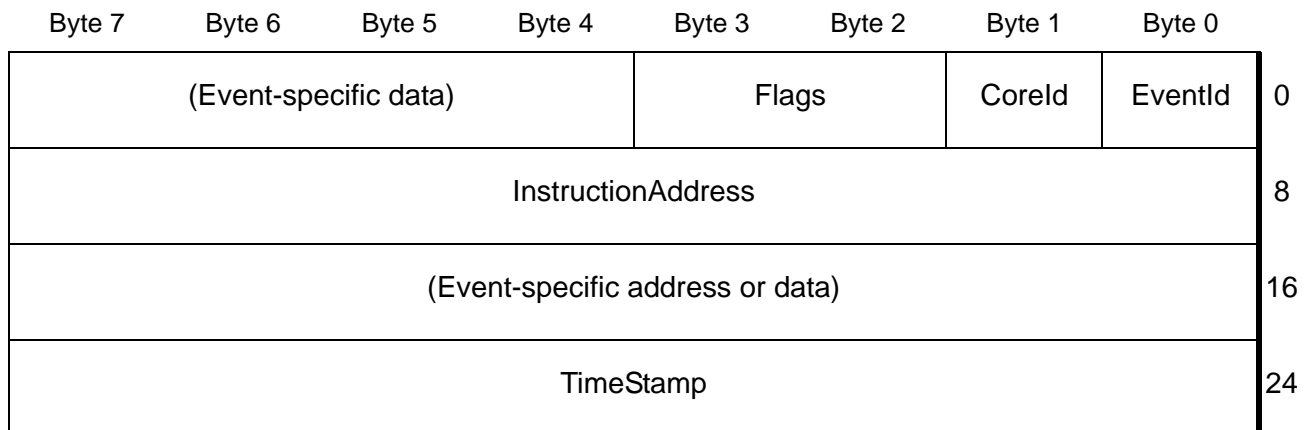

Bytes	Field	Description
0	EventId	Event identifier specifying the event record type. Valid identifiers are 1 to 255. 0 is an invalid identifier.
1	CoreId	CPU core identifier value from COREID field of LWP_CFG (see “LWP_CFG—LWP Configuration MSR” on page 402). For multicore systems, this typically identifies the core on which LWP is running. This allows software to aggregate event records from multiple threads into a single data structure without losing CPU information. It also allows software to detect when a thread has migrated from one core to another.
3–2	Flags	Event-specific flags.
7–4		Event-specific data.
15–8	InstructionAddress	The Effective Address of the instruction that triggered this event record. This is the value before adding in the CS base address. If the base is non-zero, software must track it. (Modern operating systems use a CS base of zero, and CS is unused in long mode.)
23–16		Event-specific address or other data.
31–24	TimeStamp	Performance Time Stamp Counter value if LWP was started with LWPCB.Flags.PTSC = 1, zero otherwise.

**Figure 13-21. Generic Event Record**

Table 13-6 below lists the event identifiers for the events defined in version 1 of LWP. They are described in detail in the following sections.

**Table 13-6. EventId Values**

EventId	Description
0	Reserved – invalid event
1	Programmed value sample
2	Instructions retired
3	Branches retired
4	DCache misses

**Table 13-6. EventId Values (continued)**

EventId	Description
5	CPU clocks not halted
6	CPU reference clocks not halted
255	Programmed event

**13.4.2.1 Programmed Value Sample**

LWP decrements the event counter each time the program executes the LWPVAL instruction (see “LWPVAL—Insert Value Sample in LWP Ring Buffer” on page 407). When the counter becomes negative, it stores an event record with an EventId of 1. The data in the event record come from the operands to the instruction as detailed in the instruction description.

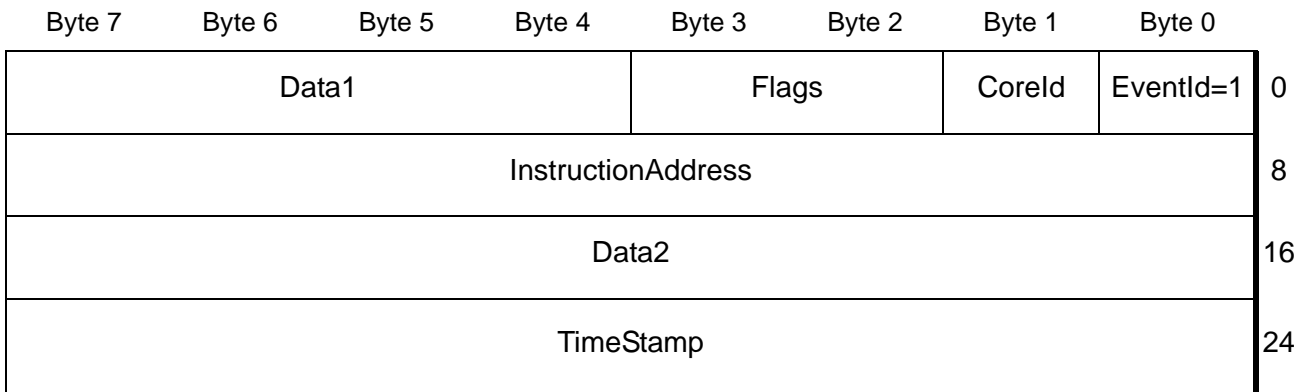

Bytes	Field	Description
0	EventId	Event identifier = 1
1	CoreId	CPU core identifier from LWP_CFG
3–2	Flags	Immediate value (bottom 16 bits)
7–4	Data1	Reg/mem value
15–8	InstructionAddress	Instruction address of LWPVAL instruction
23–16	Data2	Reg value (zero extended if running in legacy mode)
31–24	TimeStamp	Performance Time Stamp Counter value if LWP was started with LWPCB.Flags.PTSC = 1, zero otherwise.

**Figure 13-22. Programmed Value Sample Event Record**

**13.4.2.2 Instructions Retired**

LWP decrements the event counter each time an instruction retires. When the counter becomes negative, it stores a generic event record with an EventId of 2.

Instructions are counted if they execute entirely in user mode (CPL = 3). Instructions that change to CPL 3 from some other level are not counted, since the instruction address is not an address in user mode space. All user mode instructions are counted, including LWPVAL and LWPINS.

Byte 7	Byte 6	Byte 5	Byte 4	Byte 3	Byte 2	Byte 1	Byte 0	
Reserved				Reserved		CoreId	EventId=2	0
InstructionAddress								8
Reserved								16
TimeStamp								24

Bytes	Bits	Field	Description
0	7:0	EventId	Event identifier = 2
1	7:0	CoreId	CPU identifier from LWP_CFG
7–2			Reserved
15–8		InstructionAddress	Instruction address
23–16			Reserved
31–24		TimeStamp	Performance Time Stamp Counter value if LWP was started with LWPCB.Flags.PTSC = 1, zero otherwise.

**Figure 13-23. Instructions Retired Event Record**

### 13.4.2.3 Branches Retired

LWP decrements the event counter each time a transfer of control retires, regardless of whether or not it is taken. When the counter becomes negative, it stores an event record with an EventId of 3.

Control transfer instructions that are counted are:

- JMP (near), Jcc, JCXZ, JEXCZ, and JRCXZ
- LOOP, LOOPE, and LOOPNE
- CALL (near) and RET (near)

LWP does not count JMP (far), CALL (far), RET (far), traps, or interrupts (whether synchronous or asynchronous), nor does it count operations that switch to or from ring 3, SMM, or SVM, such as SYSCALL, SYSENTER, SYSEXIT, SYSRET, VMPCALL, INT, or INTO.

Some implementations of the AMD64 architecture perform an optimization called “fusing” when a compare operation (or other operation that sets the condition codes) is followed immediately by a conditional branch. The processor fuses these into a single operation internally before they are executed. While this is invisible to the programmer, the address of the actual branch is not available for LWP to report when the (fused) instruction retires. In this case, LWP sets the FUS bit in the event record and reports the address of the operation that set the condition codes. If FUS is set, software can find the address of the actual branch by decoding the instruction at the reported InstructionAddress and

adding its length to that address. (Note that fused instructions do count as 2 instructions for the Instructions Retired event, since there were 2 x86 instructions originally.)



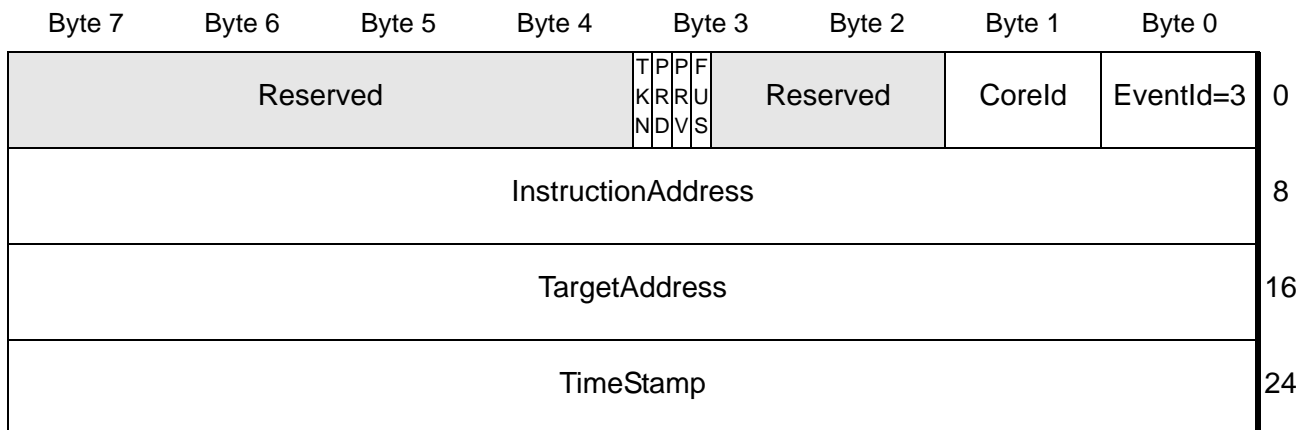

Bytes	Bits	Field	Description
0	7:0	EventId	Event identifier = 3
1	7:0	CoreId	CPU core identifier from LWP_CFG
3–2	11:0		Reserved
3	4	FUS	1—Fused operation. InstructionAddress points to a compare operation (or other operation that sets the condition codes) immediately preceding the branch. 0—InstructionAddress points to the branch instruction.
3	5	PRV	1—PRD bit is valid 0—Prediction information is not available Some implementations of LWP may be unable to capture branch prediction information on some or all branches.
3	6	PRD	1—Branch was predicted correctly 0—Mispredicted If PRV = 0, the value of PRD is unpredictable and should be ignored. For unconditional branches, PRD=1 if PRV=1.
3	7	TKN	1—Branch was taken 0—Branch not taken Always 1 for unconditional branches.
7–4			Reserved
15–8		InstructionAddress	Instruction address
23–16		TargetAddress	Address of instruction executed after branch. This is the target if the branch was taken and the fall-through address if the branch was a not-taken conditional branch. TargetAddress is the Effective Address value before adding in the CS base address.
31–24		TimeStamp	Performance Time Stamp Counter value if LWP was started with LWPCB.Flags.PTSC = 1, zero otherwise.

**Figure 13-24. Branch Retired Event Record**

#### 13.4.2.4 DCache Misses

LWP decrements the event counter each time a load from memory causes a DCache miss whose latency exceeds the `LwpCacheLatency` threshold and/or whose data come from a level of the cache or memory hierarchy that is selected for counting. When the counter becomes negative, LWP stores an event record with an `EventId` of 4.

A misaligned access that causes two misses on a single load decrements the event counter by 1 and, if it reports an event, the data are for the lowest address that missed. LWP only counts loads directly caused by the instruction. It does not count cache misses that are indirectly due to TLB walks, LDT or GDT references, TLB misses, etc. Cache misses caused by LWP itself accessing the LWPCB or the event ring buffer are not counted.

#### Measuring Latency

The x86 architecture allows multiple loads to be outstanding simultaneously. An implementation of LWP might not have a full latency counter for every load that is waiting for a cache miss to be resolved. Therefore, an implementation may apply any of the following simplifications. Software using LWP should be prepared for this.

- The implementation may round the latency to a multiple of  $2^j$ . This is a small power of 2, and the value of  $j$  must be 1 to 4. For example, in the rest of this section, assume that  $j = 4$ , so  $2^j = 16$ . The low 4 bits of latency reported in the event record will be 0. The actual latency counter is incremented by 16 every 16 cycles of waiting. The value of  $j$  is returned as `LwpLatencyRnd` (see “Detecting LWP Capabilities” on page 399).
- The implementation may do an approximation when starting to count latency. If counting is in increments of 16, the 16 cycles need not start when the load begins to wait. The implementation may bump the latency value from 0 to 16 any time during the first 16 cycles of waiting.
- The implementation may cap total latency to  $2^n - 16$  (where  $n \geq 10$ ). The latency counter is thus a saturating counter that stops counting when it reaches its maximum value. For example, if  $n = 10$ , the latency value will count from 0 to 1008 in steps of 16 and then stop at 1008. (If  $n = 10$ , each counter is only 6 bits wide.) The value of  $n$  is returned as `LwpLatencyMax` (see “Detecting LWP Capabilities” on page 399).

Note that the latency threshold used to filter events is a multiple of 16. This value is used in the comparison that decides whether a cache miss event is eligible to be counted.

#### Reporting the DCache Miss Data Address

The event record for a DCache miss reports the linear address of the data (after adding in the segment base address, if any). The way an implementation records the linear address affects the exact event that is reported and the amount of time it takes to report a cache miss event. The implementation may report the event immediately, report the next eligible event once the counter becomes negative, or replay the instruction.

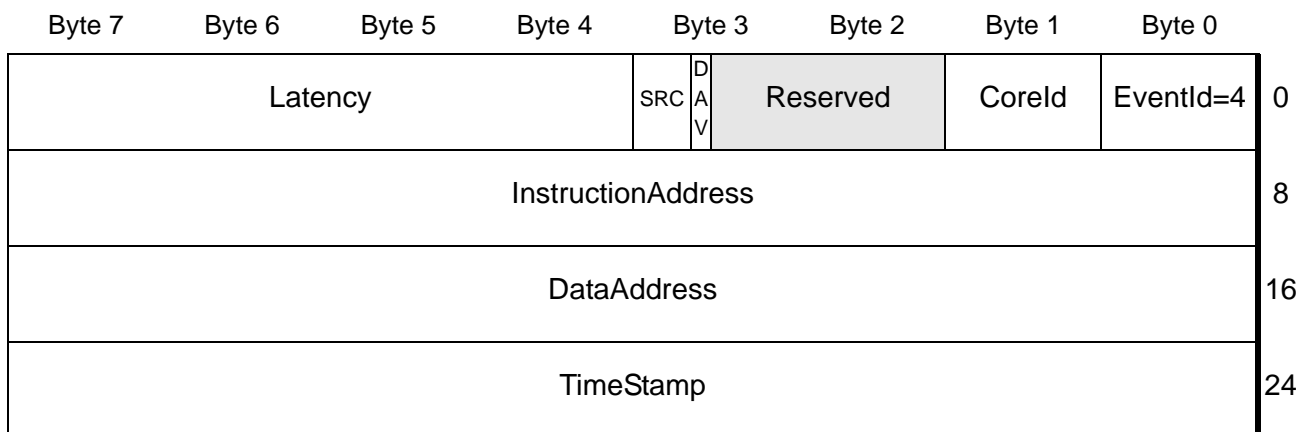

Bytes	Bits	Field	Description
0	7:0	EventId	Event identifier = 4
1	7:0	CoreId	CPU identifier from LWP_CFG
2–3	11:0		Reserved
3	4	DAV	1—DataAddress is valid 0—Address is unavailable
			Data source for the requested data
			0 No valid status
			1 Local L3 cache
			2 Remote CPU or L3 cache
			3 DRAM
3	5:7	SRC	4 Reserved (for Remote cache)
			5 Reserved
			6 Reserved
			7 Other (MMIO/Config/PCI/APIC)
7–4		Latency	Total latency of cache miss (in cycles)
15–8		InstructionAddress	Instruction address
23–16		DataAddress	Address of memory reference (if flag bit 28 = 1)
31–24		TimeStamp	Performance Time Stamp Counter value if LWP was started with LWPCB.Flags.PTSC = 1, zero otherwise.

**Figure 13-25. DCache Miss Event Record**

### 13.4.2.5 CPU Clocks not Halted

LWP decrements the event counter each clock cycle that the CPU is not in a halted state (due to STPCLK or a HLT instruction). When the counter becomes negative, it stores a generic event record with an EventId of 5. This counter varies in real-time frequency as the core clock frequency changes.

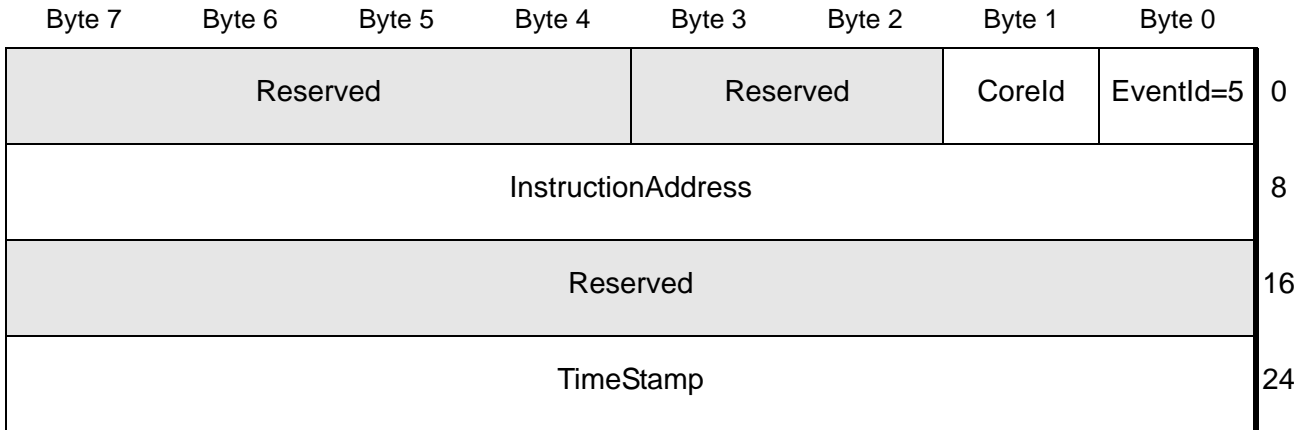

Bytes	Bits	Field	Description
0	7:0	EventId	Event identifier = 5
1	7:0	CoreId	CPU identifier from LWP_CFG
7-2			Reserved
15-8		InstructionAddress	Instruction address
23-16			Reserved
31-24		TimeStamp	Performance Time Stamp Counter value if LWP was started with LWPCB.Flags.PTSC = 1, zero otherwise.

**Figure 13-26. CPU Clocks not Halted Event Record**

**13.4.2.6 CPU Reference Clocks not Halted**

LWP decrements the event counter each reference clock cycle that the CPU is not in a halted state (due to STPCLK or a HLT instruction). When the counter becomes negative, it stores a generic event record with an EventId of 6.

The reference clock runs at a constant frequency that is independent of the core frequency and of the performance state. The reference clock frequency is processor dependent. The processor may implement this event by subtracting the ratio of (reference clock frequency / core clock frequency) each core clock cycle.

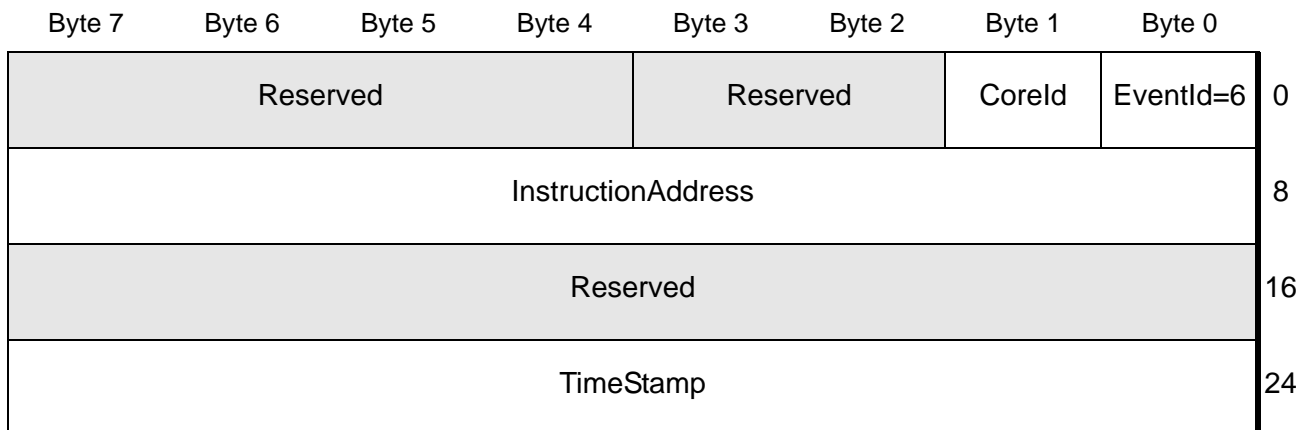

Bytes	Bits	Field	Description
0	7:0	EventId	Event identifier = 6
1	7:0	CoreId	CPU identifier from LWP_CFG
2–7		Reserved	Reserved
15–8		InstructionAddress	Instruction address
23–16		Reserved	Reserved
31–24		TimeStamp	Performance Time Stamp Counter value if LWP was started with LWPCB.Flags.PTSC = 1, zero otherwise.

**Figure 13-27. CPU Reference Clocks not Halted Event Record**

### 13.4.2.7 Programmed Event

When a program executes the LWPINS instruction (see “LWPINS—Insert User Event Record in LWP Ring Buffer” on page 408), the processor stores an event record with an event identifier of 255. The data in the event record come from the operands to the instruction as detailed in the instruction description.

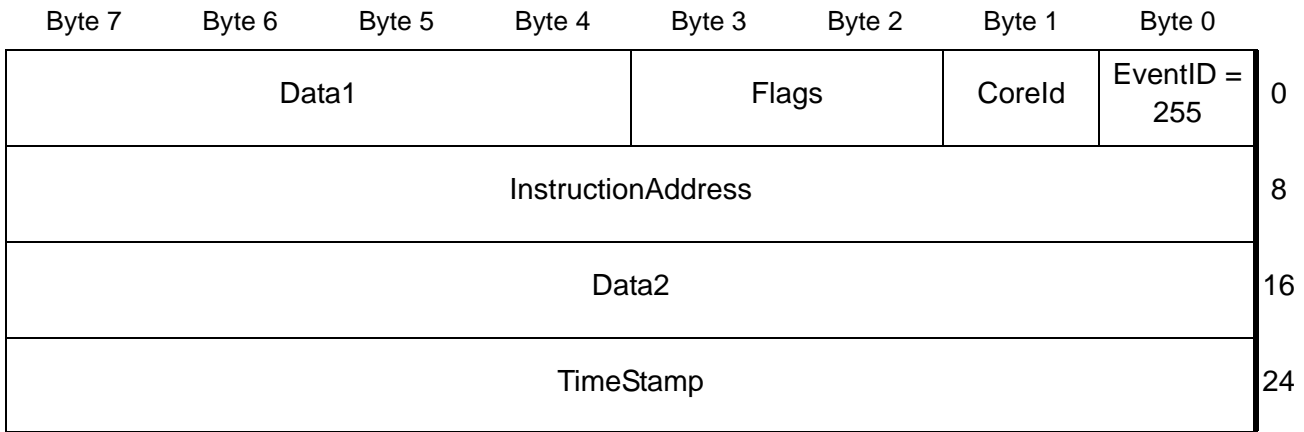

Bytes	Field	Description
0	EventId	Event identifier = 255
1	CoreId	CPU identifier from LWP_CFG
3–2	Flags	Imm16 value
7–4	Data1	Reg/mem value
15–8	InstructionAddress	Instruction address of LWPINS instruction
23–16	Data2	Reg value (zero extended if running in legacy mode)
31–24	TimeStamp	Performance Time Stamp Counter value if LWP was started with LWPCB.Flags.PTSC = 1, zero otherwise.

**Figure 13-28. Programmed Event Record**

### 13.4.2.8 Other Events

The overall design of LWP allows easy extension to the list of events that it can monitor. The following are possibilities for events that may be added in future versions of LWP:

- DTLB misses
- FPU operations
- ICache misses
- ITLB misses

### 13.4.3 Detecting LWP

An application uses the CPUID instruction to identify whether Lightweight Profiling is present and which of its capabilities are available for use. An operating system uses CPUID to determine whether LWP is supported on the hardware and to determine which features of LWP are supported and can be made available to applications.

### 13.4.3.1 Detecting LWP Presence

LWP is supported on a processor if CPUID Fn8000\_0001\_ECX[LWP] (bit 15) is set. This bit is identical to the value of CPUID Fn0000\_000D\_EDX\_x0[bit 30], which is bit 62 of the XFeatureSupportedMask and indicates XSAVE support for LWP. A system can check either of those bits to determine if LWP is supported. Since LWP requires XSAVE, software can assume that this bit being set implies that CPUID Fn0000\_0001\_ECX[XSAVE] (bit 26) is also set.

### 13.4.3.2 Detecting LWP XSAVE Area

The size of the LWP extended state save area used by XSAVE/XRSTOR is 128 bytes (080h). This value is returned by CPUID Fn0000\_000D\_EAX\_x3E (ECX=62).

The offset of the LWP save area from the beginning of the XSAVE/XRSTOR area is 832 bytes (340h). This value is returned by CPUID Fn0000\_000D\_EBX\_x3E (ECX=62).

The size of the LWP save area is included in the XFeatureSupportedSizeMax value returned by CPUID Fn0000\_000D\_ECX\_x0 (ECX=0).

If LWP is enabled in the XFEATURE\_ENABLED\_MASK, the size of the LWP save area is included in the XFeatureEnabledSizeMax value returned by CPUID Fn0000\_000D\_EBX\_x0 (ECX=0).

### 13.4.3.3 Detecting LWP Capabilities

The values returned by CPUID Fn8000\_001C indicate the capabilities of LWP. See Table 13-7, “Lightweight Profiling CPUID Values” for a listing of the returned values.

Bit 0 of EAX is a copy of bit 62 from XFEATURE\_ENABLED\_MASK and indicates whether LWP is available for use by applications. If it is 1, the processor supports LWP and the operating system has enabled LWP for applications.

Bits 31:1 returned in EAX are taken from the LWP\_CFG MSR and reflect the LWP features that are available for use. These are a subset of the bits returned in EDX, which reflect the full capabilities of LWP on current processor. The operating system can make a subset of LWP available if it cannot handle all supported features. For instance, if the OS cannot handle an LWP threshold interrupt, it can disable the feature. User-mode software must assume that the bits in EAX describe the features it can use. Operating systems should use the bits from EDX to determine the supported capabilities of LWP and make all or some of those features available.

Under SVM, if a VMM allows the migration of guests among processors that all support LWP, it must arrange for CPUID to report the logical AND of the supported feature bits over all processors in the migration pool. Other CPUID values must also be reported as the “least common denominator” among the processors.

Table 13-7. Lightweight Profiling CPUID Values

Reg	Bits	Field	Description
EAX	0	LwpAvail	1—LWP is available to application programs. The hardware and the operating system support LWP. 0—LWP is not available. This bit is a copy of bit 62 of the XFEATURE_ENABLED_MASK register (XCRO).
	1	LwpVAL	LWPVAL instruction (EventId = 1) is available.
	2	LwpIRE	Instructions retired event (EventId = 2) is available.
	3	LwpBRE	Branch retired event (EventId = 3) is available.
	4	LwpDME	DCache miss event (EventId = 4) is available.
	5	LwpCNH	CPU clocks not halted event (EventId = 5) is available.
	6	LwpRNH	CPU reference clocks not halted event (EventId = 6) is available.
	28:7		Reserved
	29	LwpCont	Sampling in continuous mode is available.
	30	LwpPTSC	Performance Time Stamp Counter in event records is available.
31	LwpInt	Interrupt on threshold overflow is available.	
EBX	7:0	LwpCbSize	Size in quadwords of the LWPCB. This value is at least (LwpEventOffset / 8) + LwpMaxEvents but an implementation may require a larger control block.
	15:8	LwpEventSize	Size in bytes of an event record in the LWP event ring buffer. (32 for LWP Version 1.)
	23:16	LwpMaxEvents	Maximum supported EventId value (not including EventId 255 used by the LWPINS instruction). Not all events between 1 and LwpMaxEvents are necessarily supported.
	31:24	LwpEventOffset	Offset from the start of the LWPCB to the EventInterval1 field. Software uses this value to locate the area of the LWPCB that describes events to be sampled. This permits expansion of the initial fixed region of the LWPCB. LwpEventOffset is always a multiple of 8.



Table 13-7. Lightweight Profiling CPUID Values

Reg	Bits	Field	Description
ECX	4:0	LwpLatencyMax	Number of bits in cache latency counters (10 to 31). 0 if DCache miss event is not supported (EDX[LwpDME] = 0).
	5	LwpDataAddress	1—Cache miss event records report the data address of the reference. 0—Data address is not reported. 0 if DCache miss event is not supported (EDX[LwpDME] = 0).
	8:6	LwpLatencyRnd	The amount by which cache latency is rounded. The bottom LwpLatencyRnd bits of latency information will be zero. The actual number of bits implemented for the counter is (LwpLatencyMax – LwpLatencyRnd). Must be 0 to 4. 0 if DCache miss event is not supported (EDX[LwpDME] = 0).
	15:9	LwpVersion	Version of LWP implementation. (1 for LWP Version 1.)
	23:16	LwpMinBufferSize	Minimum size of the LWP event ring buffer, in units of 32 event records. At least 32*LwpMinBufferSize records must be allocated for the LWP event ring buffer, and hence the size of the ring buffer must be at least 32 * LwpMinBufferSize * LwpEventSize bytes. If 0, there is no minimum.
	27:24		Reserved
	28	LwpBranchPrediction	1—Branches Retired events can be filtered based on whether the branch was predicted properly. The values of NMB and NPB in the LWPCB enable filtering based on prediction. 0—NMB and NPB fields of the LWPCB are ignored. 0 if Branches Retired event is not supported (EDX[LwpBRE] = 0).
	29	LwplpFiltering	1—IP filtering is supported. 0—IP filtering is not supported. The IPI, IPF, BaseIP, and LimitIP fields of the LWPCB are ignored.
	30	LwpCacheLevels	1—Cache-related events can be filtered by the cache level that returned the data. The value of CLF in the LWPCB enables cache level filtering. 0—CLF is ignored. An implementation must support filtering either by latency or by cache level. It may support both. 0 if DCache miss event is not supported (EDX[LwpDME] = 0).
	31	LwpCacheLatency	1—Cache-related events can be filtered by latency. The value of MinLatency in the LWPCB controls filtering. 0—MinLatency is ignored. An implementation must support filtering either by latency or by cache level. It may support both. 0 if DCache miss event is not supported (EDX[LwpDME] = 0).

Table 13-7. Lightweight Profiling CPUID Values

Reg	Bits	Field	Description
EDX	0	LwpAvail	LWP is supported. If 0, the remainder of the data returned by CPUID should be ignored. This bit is a copy of CPUID Fn8000_0001_ECX[LWP] (bit 15).
	1	LwpVAL	LWPVAL instruction (EventId = 1) is supported.
	2	LwpIRE	Instructions retired event (EventId = 2) is supported.
	3	LwpBRE	Branch retired event (EventId = 3) is supported.
	4	LwpDME	DCache miss event (EventId = 4) is supported.
	5	LwpCNH	CPU clocks not halted event (EventId = 5) is supported.
	6	LwpRNH	CPU reference clocks not halted event (EventId = 6) is supported.
	28:7		Reserved
	29	LwpCont	Sampling in continuous mode is supported.
	30	LwpPTSC	Performance Time Stamp Counter in event records is supported.
	31	LwpInt	Interrupt on threshold overflow is supported.

For more information on using the CPUID instruction, refer to Section 3.3, “Processor Feature Identification,” on page 63.

### 13.4.4 LWP Registers

The XFEATURE\_ENABLED\_MASK register (extended control register XCR0) and the LWP model-specific registers describe and control the LWP hardware. The MSRs are available if CPUID Fn8000\_0001\_ECX[LWP] (bit 15) is set. LWP can only be used if the system has made support for LWP state management available in XFEATURE\_ENABLED\_MASK.

#### 13.4.4.1 XFEATURE\_ENABLED\_MASK Support

LWP requires that the processor support the XSAVE/XRSTOR instructions to manage LWP state, along with the XSETBV/XGETBV instructions that manage the enabled state mask. An operating system uses XSETBV to set bit 62 of XFEATURE\_ENABLED\_MASK to indicate that it supports management of LWP state and allows applications to use LWP. When the system makes LWP available by setting bit 62 of XFEATURE\_ENABLED\_MASK, LWP is initially disabled (LWP\_CBADDR is zero).

See “Guidelines for Operating Systems” on page 425 for details on how to implement LWP support in an operating system.

#### 13.4.4.2 LWP\_CFG—LWP Configuration MSR

LWP\_CFG (MSR C000\_0105h) controls which features of LWP are available on the processor. The operating system loads LWP\_CFG at start-up time (or at the time an LWP driver is loaded) to indicate

its level of support for LWP. Only bits for supported features (those that are set in CPUID Fn8000\_001C\_EDX) can be turned on in LWP\_CFG. Attempting to set other bits causes a #GP fault.

User code can examine LWP\_CFG bits 31:1 by reading CPUID Fn8000\_001C\_EAX.

Bits 39:32 of LWP\_CFG contains the COREID value that LWP will store into the CoreId field of every event record written by this core. The operating system should initialize this value to be the local APIC number, obtained from CPUID Fn0000\_0001\_EBX[LocalApicId] (bits 31:24). COREID is present so that when LWP is used in a virtualized environment, it has access to the core number without needing to enter the hypervisor. On systems that support x2APIC, local APIC numbers may be more than 8 bits wide. The operating system may then assign LWP COREID values that are small and identify the core within a cluster. If the system has more than 256 cores, there will be unavoidable duplication of COREID values.

Bits 47:40 of LWP\_CFG specify the vector number that LWP will use when it signals a ring buffer threshold interrupt.

The reset value of LWP\_CFG is 0.

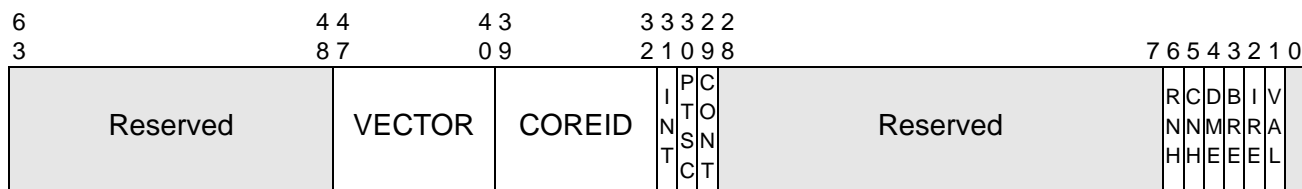

Bits	Field	Description
0		Reserved
1	VAL	Allow the LWPVAL instruction.
2	IRE	Allow LWP to count instructions retired.
3	BRE	Allow LWP to count branches retired.
4	DME	Allow LWP to count DCache misses.
5	CNH	Allow LWP to count CPU clocks not halted.
6	RNH	Allow LWP to count CPU reference clocks not halted.
28:7		Reserved
29	CONT	Enable continuous mode. If 0, LWP will always use synchronized mode.
30	PTSC	Enable storing Performance Time Stamp Counter (PTSC) in the TimeStamp field of event records, if PTSC is available.
31	INT	Allow LWP to generate an interrupt when threshold is exceeded.
39:32	COREID	Value to store in CoreId field when writing an event record.
47:40	VECTOR	Interrupt vector number to use for LWP Threshold interrupts. Must be provided if INT=1.
63:48		Reserved

**Figure 13-29. LWP\_CFG—Lightweight Profiling Features MSR**

### 13.4.4.3 LWP\_CBADDR—LWPCB Address MSR

LWP\_CBADDR (MSR C000\_0106h) provides access to the internal copy of the LWPCB linear address.

RDMSR from this register returns the current LWPCB address without performing any of the operations described for the SLWPCB instruction.

WRMSR to this register with a non-zero value generates a #GP fault; use LLWPCB or XRSTOR to load an LWPCB address.

Writing a zero to LWP\_CBADDR immediately disables LWP, discarding any internal state. For instance, an operating system can write a zero to stop LWP when it terminates a thread.

Note that LWP\_CBADDR contains the linear address of the control block. All references to the LWPCB that are made by microcode during the normal operation of LWP ignore the DS segment register.

The reset value of LWP\_CBADDR is 0. This means that when the system sets bit 62 of XFEATURE\_ENABLED\_MASK to make LWP available, it is initially disabled.

## 13.4.5 LWP Instructions

This section describes the instructions included in the AMD64 architecture to support LWP. These instructions raise #UD if LWP is not supported or if bit 62 of XFEATURE\_ENABLED\_MASK is 0 indicating that LWP is not available.

The LLWPCB instruction enables or disables Lightweight Profiling and controls the events being profiled. The SLWPCB instruction queries the current state of Lightweight Profiling.

LWP provides two instructions for inserting user data into the event ring buffer. The LWPINS instruction unconditionally stores an event record into the ring buffer, while the LWPVAL instruction uses an LWP event counter to sample program values at defined intervals.

The instructions LLWPCB, SLWPCB, LWPINS, and LWPVAL are also described in the chapter "General-Purpose Instruction Reference" of Volume 3. Refer to reference pages for the individual instruction for information on instruction encoding, flags affected, and exception behavior.

### 13.4.5.1 LLWPCB—Load LWPCB Address

Parses the Lightweight Profiling Control Block at the address contained in the specified register. If the LWPCB is valid, writes the address into the LWP\_CBADDR MSR and enables Lightweight Profiling.

The LWPCB must be in memory that is readable and writable in user mode. For better performance, it should be aligned on a 64-byte boundary in memory and placed so that it does not cross a page boundary, though neither of these suggestions is required.

**Action**

1. If LWP is not available or if the machine is not in protected mode, LLWPCB immediately causes a #UD exception.
2. If LWP is already enabled, the processor flushes the LWP state to memory in the old LWPCB. See “SLWPCB—Store LWPCB Address” on page 406 for details on saving the active LWP state.  
If the flush causes a #PF exception, LWP remains enabled with the old LWPCB still active. Note that the flush is done before LWP attempts to access the new LWPCB.
3. If the specified LWPCB address is 0, LWP is disabled and the execution of LLWPCB is complete.
4. The LWPCB address is non-zero. LLWPCB validates it as follows:
  - If any part of the LWPCB or the ring buffer is beyond the data segment limit, LLWPCB causes a #GP exception.
  - If the ring buffer size is below the implementation’s minimum ring buffer size, LLWPCB causes a #GP exception.
  - While doing these checks, LWP reads and writes the LWPCB, which may cause a #PF exception.

If any of these exceptions occurs, LLWPCB aborts and LWP is left disabled. Usually, the operating system will handle a #PF exception by making the memory available and returning to retry the LLWPCB instruction. The #GP exceptions indicate application programming errors.

5. LWP converts the LWPCB address and the ring buffer address to linear address form by adding the DS base address and stores the addresses internally.
6. LWP examines the LWPCB.Flags field to determine which events should be enabled and whether threshold interrupts should be taken. It clears the bits for any features that are not available and stores the result back to LWPCB.Flags to inform the application of the actual LWP state.
7. For each event being enabled, LWP examines the EventInterval $n$  value and, if necessary, sets it to an implementation-defined minimum. (The minimum event interval for LWPVAL is zero.) It loads its internal counter for the event from the value in EventCounter $n$ . A zero or negative value in EventCounter $n$  means that the next event of that type will cause an event record to be stored. To count every  $j^{\text{th}}$  event, a program should set EventInterval $n$  to  $j-1$  and EventCounter $n$  to some starting value (where  $j-1$  is a good initial count). If the counter value is larger than the interval, the first event record will be stored after a larger number of events than subsequent records.
8. LWP is started. The execution of LLWPCB is complete.

**Notes**

If none of the bits in the LWPCB.Flags specifies an available event, LLWPCB still enables LWP to allow the use of the LWPINS instruction. However, no other event records will be stored.

A program can temporarily disable LWP by executing SLWPCB to obtain the current LWPCB address, saving that value, and then executing LLWPCB with a register containing 0. It can later re-enable LWP by executing LLWPCB with a register containing the saved address.

When LWP is enabled, it is typically an error to execute LLWPCB with the address of the active LWPCB. When the hardware flushes the existing LWP state into the LWPCB, it may overwrite fields that the application may have set to new LWP parameter values. The flushed values will then be loaded as LWP is restarted. To reuse an LWPCB, an application should stop LWP by passing a zero to LLWPCB, then prepare the LWPCB with new parameters and execute LLWPCB again to restart LWP.

Internally, LWP keeps the linear address of the LWPCB and the ring buffer. If the application changes the value of DS, LWP will continue to collect samples even if the new DS value would no longer allow it to access the LWPCB or the ring buffer. However, a #GP fault will occur if the application uses XRSTOR to restore LWP state saved by XSAVE. Programs should avoid using XSAVE/XRSTOR on LWP state if DS has changed. This only applies when the CPL  $\neq$  0; kernel mode operation of XRSTOR is unaffected by changes to DS. See “XSAVE/XRSTOR” on page 418 for details.

Operating system and hypervisor code that runs when the CPL  $\neq$  3 should use XSAVE and XRSTOR to control LWP rather than using LLWPCB (see below). Use WRMSR to write 0 to LWP\_CBADDR to immediately stop LWP without saving its current state (see “LWP\_CBADDR—LWPCB Address MSR” on page 404).

It is possible to execute LLWPCB when the CPL  $\neq$  3 or when SMM is active, but the system software must ensure that the LWPCB and the entire ring buffer are properly mapped into writable memory in order to avoid a #PF or #GP fault. Furthermore, if LWP is enabled when a kernel executes LLWPCB, both the old and new control blocks and ring buffers must be accessible. Using LLWPCB in these situations is not recommended.

#### 13.4.5.2 SLWPCB—Store LWPCB Address

Flushes LWP state to memory and returns the current effective address of the LWPCB in the specified register.

If LWP is not currently enabled, SLWPCB sets the specified register to zero.

The flush operation stores the internal event counters for active events and the current ring buffer head pointer into the LWPCB. If there is an unwritten event record pending, it is written to the event ring buffer.

If LWP\_CBADDR is not zero, the value returned is an effective address that is calculated by subtracting the current DS.Base address from the linear address kept in LWP\_CBADDR. Note that if DS has changed between the time LLWPCB was executed and the time SLWPCB is executed, this might result in an address that is not currently accessible by the application.

SLWPCB generates an invalid opcode exception (#UD) if the machine is not in protected mode or if LWP is not available.

It is possible to execute SLWPCB when the CPL  $\neq$  3 or when SMM is active, but if the LWPCB pointer is not zero, the system software must ensure that the LWPCB and the entire ring buffer are properly mapped into writable memory in order to avoid a #PF fault. Using SLWPCB in these situations is not recommended.

### 13.4.5.3 LWPVAL—Insert Value Sample in LWP Ring Buffer

Decrements the event counter associated with the Programmed Value Sample event (see “Programmed Value Sample” on page 390). If the resulting counter value is negative, inserts an event record into the LWP event ring buffer in memory and advances the ring buffer pointer. If the counter is not negative and the ModRM operand specifies a memory location, that location is not accessed.

The event record has an EventId of 1. The value in the register specified by vvvv (first operand) is stored in the Data2 field at bytes 23–16 (zero extended if the operand size is 32). The value in a register or memory location (second operand) is stored in the Data1 field at bytes 7–4. The immediate value (third operand) is truncated to 16 bits and stored in the Flags field at bytes 3–2. See Figure 13-22 on page 390.

If the ring buffer is not full or if LWP is running in continuous mode, the head pointer is advanced and the event counter is reset to the interval for the event (subject to randomization). If the ring buffer threshold is exceeded and threshold interrupts are enabled, an interrupt is signaled. If LWP is in continuous mode and the new head pointer equals the tail pointer, the MissedEvents counter is incremented to indicate that the buffer wrapped.

If the ring buffer is full and LWP is running in synchronized mode, the event record overwrites the last record in the buffer, the MissedEvents counter in the LWPCB is incremented, and the head pointer is not advanced.

LWPVAL generates an invalid opcode exception (#UD) if the machine is not in protected mode or if LWP is not available.

LWPVAL does nothing if LWP is not enabled or if the Programmed Value Sample event is not enabled in LWPCB.Flags. This allows LWPVAL instructions to be harmlessly ignored if profiling is turned off.

It is possible to execute LWPVAL when the CPL  $\neq$  3 or when SMM is active, but the system software must ensure that the memory operand (if present), the LWPCB, and the entire ring buffer are properly mapped into writable memory in order to avoid a #PF or #GP fault. Using LWPVAL in these situations is not recommended.

LWPVAL can be used by a program to perform value profiling. This is the technique of sampling the value of some program variable at a predetermined frequency. For example, a managed runtime might use LWPVAL to sample the value of the divisor for a frequently executed divide instruction in order to determine whether to generate specialized code for a common division. It might sample the target location of an indirect branch or call to see if one destination is more frequent than others. Since LWPVAL does not modify any registers or condition codes, it can be inserted harmlessly between any instructions.

#### Note

When LWPVAL completes (whether or not it stored an event record in the event ring buffer), it counts as an instruction retired. If the Instructions Retired event is active, this might cause that counter to become negative and immediately store an event record. If LWPVAL also stored an event record, the buffer will contain two records with the same instruction address (but different EventId values).

#### 13.4.5.4 LWPINS—Insert User Event Record in LWP Ring Buffer

Inserts a record into the LWP event ring buffer in memory and advances the ring buffer pointer.

The record has an EventId of 255. The value in the register specified by vvvv (first operand) is stored in the Data2 field at bytes 23–16 (zero extended if the operand size is 32). The value in a register or memory location (second operand) is stored in the Data1 field at bytes 7–4. The immediate value (third operand) is truncated to 16 bits and stored in the Flags field at bytes 3–2. See Figure 13-28 on page 398.

If the ring buffer is not full or if LWP is running in continuous mode, the head pointer is advanced and the CF flag is cleared. If the ring buffer threshold is exceeded and threshold interrupts are enabled, an interrupt is signaled. If LWP is in continuous mode and the new head pointer equals the tail pointer, the MissedEvents counter is incremented to indicate that the buffer wrapped.

If the ring buffer is full and LWP is running in synchronized mode, the event record overwrites the last record in the buffer, the MissedEvents counter in the LWPCB is incremented, the head pointer is not advanced, and the CF flag is set.

LWPINS generates an invalid opcode exception (#UD) if the machine is not in protected mode or if LWP is not available.

LWPINS simply clears CF if LWP is not enabled. This allows LWPINS instructions to be harmlessly ignored if profiling is turned off.

It is possible to execute LWPINS when the CPL  $\neq$  3 or when SMM is active, but the system software must ensure that the memory operand (if present), the LWPCB, and the entire ring buffer are properly mapped into writable memory in order to avoid a #PF or #GP fault. Using LWPINS in these situations is not recommended.

LWPINS can be used by a program to mark significant events in the ring buffer as they occur. For instance, a program might capture information on changes in the process' address space such as library loads and unloads, or changes in the execution environment such as a change in the state of a user-mode thread of control.

Note that when the LWPINS instruction finishes writing a event record in the event ring buffer, it counts as an instruction retired. If the Instructions Retired event is active, this might cause that counter to become negative and immediately store another event record with the same instruction address (but different EventId values).

#### 13.4.6 LWP Control Block

An application uses the LWP Control Block (LWPCB) to specify the details of Lightweight Profiling operation. It is an interactive region of memory in which some fields are controlled and modified by the LWP hardware and others are controlled and modified by the software that processes the LWP event records.



Most of the fields in the LWPCB are constant for the duration of a LWP session (the time between enabling LWP and disabling it). This means that they are loaded into the LWP hardware when it is enabled, and may be periodically reloaded from the same location as needed. The contents of the constant fields must not be changed during a LWP run or results will be unpredictable. Changing the LWPCB memory to read-only or unmapped will cause an exception the next time LWP attempts to access it. To change values in the LWPCB, disable LWP, change the LWPCB (or create a new one), and re-enable LWP.

A few fields are modified by the LWP hardware to communicate progress to the software that is emptying the event ring buffer. Software may read them but should never modify them during an LWP session. Other fields are for software to modify to indicate that progress has been made in emptying the ring buffer. Software writes these fields and the LWP hardware reads them as needed.

For efficiency, some of the LWPCB fields may be shadowed internally in the LWP hardware unit when profiling is enabled. LWP refreshes these fields from (or flushes them to) memory as needed to allow software to make progress. For more information, refer to “LWPCB Access” on page 424.

The BufferTailOffset field is at offset 64 in the LWPCB in order to place it in a separate cache line on most implementations, assuming that the LWPCB itself is aligned properly. This allows the software thread that is emptying the ring buffer to retain write ownership of that cache line without colliding with the changes made by LWP when writing BufferHeadOffset. In addition, most implementations will use a value of 128 as the offset to the EventInterval1 field, since that places the event information in a separate cache line.

All fields in the LWPCB (as shown in Figure 13-30) that are marked as “Reserved” (or “Rsvd”) should be zero.

Byte 7	Byte 6	Byte 5	Byte 4	Byte 3	Byte 2	Byte 1	Byte 0
Random	BufferSize			Flags			0
BufferBase							8
Reserved			BufferHeadOffset				16
MissedEvents							24
Filters			Threshold				32
BaseIP							40
LimitIP							48
Reserved							56
Reserved			BufferTailOffset				64
Reserved for software							72
Reserved for software							80
: Reserved :							88
7	2	25	0	7	2	25	0
Rsvd	EventCounter1			Rsvd	EventInterval1		<i>E</i>
							<i>E = LwpEventOffset</i>
7	2	25	0	7	2	25	0
Rsvd	EventCounter2			Rsvd	EventInterval2		<i>E</i>
							+8
...							
7	2	25	0	7	2	25	0
Rsvd	EventCounter <i>N</i>			Rsvd	EventInterval <i>N</i>		...
							<i>N = LwpMaxEvents</i>

Figure 13-30. LWPCB—Lightweight Profiling Control Block

The R/W column in Table 13-8 below indicates how a field is used while LWP is enabled:

- LWP—hardware modifies the field; software may read it, but must not change it
- Init—hardware reads and modifies the field while executing LLWPCB; the field must then remain unchanged as long as the LWPCB is in use
- SW—software may modify the field; hardware may read it, but does not change it
- No—field must remain unchanged as long as the LWPCB is in use

**Table 13-8. LWPCB—Lightweight Profiling Control Block Fields**

Bytes	Bits	Field	Description	R/W
3–0		Flags	Flags indicating which events should be or are being counted (see Figure 13-31, “LWPCB Flags”) and whether threshold interrupts should be enabled. Before executing LLWPCB, the application sets Flags to a bit mask of the events (and interrupt) that should be enabled. LLWPCB does a logical “and” of this mask with the available feature bits in LWP_CFG and rewrites Flags with the mask of features actually enabled.	Init
7–4	27:0	BufferSize	Total size of the event ring buffer (in bytes). Must be a multiple of the event record size LwpEventSize (the value used internally will be rounded down if not). BufferSize must be at least (32 * LwpMinBufferSize * LwpEventSize).	No
7	7:4	Random	Number of bits of randomness to use in counters. Each time a counter is loaded from an interval to start counting down to the next event to record, the bottom Random bits are set to a random value. This avoids fixed patterns in events.	No
15–8		BufferBase	The Effective Address of the event ring buffer. Should be aligned on a 64-byte boundary for reasonable performance. Software is encouraged to align the ring buffer to a page boundary for best performance. If the default address size is less than 64 bits, the upper bits of BufferBase must be zero. LLWPCB converts BufferBase to a linear address and stores it internally. LWPCB.BufferBase is not modified.	No
19–16		BufferHeadOffset	Unsigned offset from BufferBase specifying where the LWP hardware will store the next event record. When BufferHeadOffset == BufferTailOffset, the ring buffer is empty. BufferHeadOffset must always be less than BufferSize; LWP will use a value of 0 if BufferHeadOffset is too large. Also, it must always be a multiple of LwpEventSize; LWP will round it down if not.	LWP
23–20			Reserved	
31–24		MissedEvents	The 64-bit count of the number of events that were missed. A missed event occurs when LWP stores an event record, attempts to advance BufferHeadOffset, and discovers that it would be equal to BufferTailOffset. In this case, LWP leaves BufferHeadOffset unchanged and instead increments the MissedEvents counter. Thus, when the ring buffer is full, the last event record is overwritten.	LWP

Table 13-8. LWPCB—Lightweight Profiling Control Block Fields (continued)

Bytes	Bits	Field	Description	R/W
35–32		Threshold	<p>Threshold for signaling an interrupt to indicate that the ring buffer is filling up. If threshold interrupts are enabled in Flags, then when LWP advances BufferHeadOffset, it computes the space used as <math>((\text{BufferHeadOffset} - \text{BufferTailOffset}) \% \text{BufferSize})</math>. If the space used equals or exceeds Threshold, LWP causes an interrupt.</p> <p>If Threshold is greater than BufferSize, no interrupt will ever be taken. If Threshold is zero, an interrupt will be taken every time an event record is stored in the ring buffer.</p> <p>Threshold is an unsigned integer multiple of LwpEventSize (the value used internally will be rounded down if not).</p> <p>Ignored if threshold interrupts are not available in LWP_CFG or if they are not enabled in Flags</p>	No
39–36		Filters	Filters to qualify which events are eligible to be counted. This field includes bits to filter branch events by type and prediction status, and bits and values to filter cache events by type and latency. See Figure 13-32, “LWPCB Filters” for details.	
47–40		BaseIP	<p>Low limit of the IP filtering range. An instruction must start at a location greater than or equal to BaseIP to be in range.</p> <p>Ignored if IPF is zero or if the CUID LwlpFiltering bit is 0 to indicate that IP filtering is not supported.</p>	No
55–48		LimitIP	<p>High limit of the IP filtering range. An instruction must start at a location less than or equal to LimitIP to be in range.</p> <p>Ignored if IPF is zero or if the CUID LwlpFiltering bit is 0 to indicate that IP filtering is not supported.</p>	No
63–56			Reserved	
67–64		BufferTailOffset	Unsigned offset from BufferBase to the oldest event record in the ring buffer. BufferTailOffset is maintained by software and must always be less than BufferSize and a multiple of LwpEventSize. If software stores a value of BufferTailOffset into the LWPCB that violates these rules, the LWP hardware might not detect ring buffer overflow or threshold conditions properly.	SW
71–68			Reserved	
72–87			Reserved for software use. These bytes are never read or written by the LWP hardware	SW
(E-1)–88			Reserved area between the fixed portion of the LWPCB and the event specifiers. Should be zero. The EventInterval1 field is at offset $E = \text{LwpEventOffset}$ .	

Table 13-8. LWPCB—Lightweight Profiling Control Block Fields (continued)

Bytes	Bits	Field	Description	R/W
(E+3)– E	25:0	EventInterval1	Reset value for counting events of type EventId = 1 (Programmed Value Sample). A value of $n$ specifies that after $n+1$ (modified by Random) LWPVAL instructions, LWP will store an event record in the ring buffer. EventInterval1 is a signed value. If it is negative, LLWPCB will use zero and will store zero into EventInterval1 in the LWPCB. The Programmed Value Sample event is the only one which allows an interval to be below the implementation minimum interval value.	Init
E+3	7:2		Reserved	
(E+7)– (E+4)	25:0	EventCounter1	Starting (LLWPCB) or current (SLWPCB) value of counter. This is a signed number. LLWPCB treats a negative value as zero.	LWP
E+7	7:2		Reserved	
(E+11)– (E+8)	25:0	EventInterval2	Reset value for counting events of type EventId = 2 (Instructions Retired). A value of $n$ specifies that after $n+1$ (modified by Random) instructions are retired, LWP will store an event record in the ring buffer. EventInterval2 is a signed value. If it is negative or is below the implementation minimum, LLWPCB will use the minimum and will store that value into EventInterval2 in the LWPCB.	Init
E+11	7:2		Reserved	
(E+15)– (E+12)	57:32	EventCounter2	Starting (LLWPCB) or current (SLWPCB) value of counter. This is a signed number. LLWPCB treats a negative value as zero.	LWP
E+15	7:2		Reserved	
		Event3...	Repeat event configuration similar to EventInterval2 and EventCounter2 for EventId values from 3 to LwpMaxEvents.	

The LLWPCB instruction reads the Flags word from the LWPCB to determine which events to profile and whether threshold interrupts should be enabled. LLWPCB writes the Flags word after turning off bits corresponding to features which are not currently available.

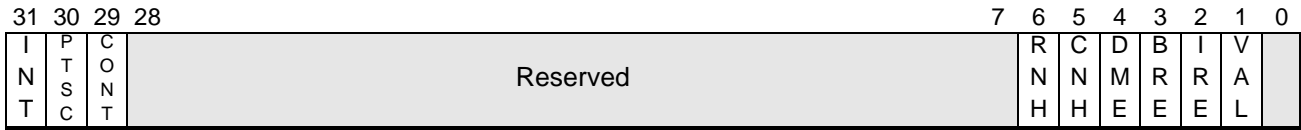

Bit	Field	Input to LLWPCB	Value after LLWPCB
0		Reserved	
1	VAL	Enable LWPVAL instruction	LWPVAL instruction enabled
2	IRE	Enable Instructions Retired event	Instructions Retired event enabled
3	BRE	Enable Branches Retired event	Branches Retired event enabled
4	DME	Enable DCache miss event	DCache Miss event enabled
5	CNH	Enable CPU clocks not halted event	CPU Clocks Not Halted event enabled
6	RNH	Enable CPU reference clocks not halted event	CPU Reference Clocks Not Halted event enabled
28:7		Reserved	
29	CONT	1—Use continuous mode. If the ring buffer overflows, LWP continues to store events and advance BufferHead. Software must stop LWP in order to empty the ring buffer. 0—Use synchronized mode.	LWP operates in continuous mode if input bit is set and continuous mode is available. Otherwise, LWP operates in synchronous mode.
30	PTSC	1—Store the Performance Time Stamp Counter (PTSC) in the TimeStamp field of each event record, if PTSC is available. 0—Store 0 in the TimeStamp field.	Performance Time Stamp Counter value will be stored if input bit is set and PTSC feature is available. Otherwise 0 is stored.
31	INT	Enable threshold interrupts.	Threshold interrupts are enabled.

**Figure 13-31. LWPVCB Flags**

Event counting can be filtered by a number of conditions which are specified in the Filters word of the LLWPCB. The IP filtering applies to all events. Cache level filtering applies to all events that interact with the caches. Branch filtering applies to the Branches Retired event.



Table 13-9. LWPCB Filters Fields

Bits	Field	Description
7:0	MinLatency	<p>Minimum latency for a cache-related event to be eligible for LWP counting. Applies to all cache-related events being monitored. MinLatency is multiplied by 16 to get the actual latency in cycles, providing less resolution but a larger range for filtering. An implementation may have a maximum for the latency value. If <math>\text{MinLatency} \times 16</math> exceeds this maximum value, the maximum is used instead. A value of 0 disables filtering by latency.</p> <p>Ignored if no cache latency event is enabled or if the CPUID LwpCacheLatency bit is 0 to indicate that the implementation does not filter by latency (use the CLF bits to get a similar effect). At least one of these mechanisms is supported if any cache miss events are supported.</p>
8	CLF	<p>Cache level filtering.</p> <p>1—Enables filtering cache-related events by the cache level or memory level that returned the data. It enables the next 4 bits. Cache-related events are only eligible for counting if the bit describing the memory level is on.</p> <p>0—Disables cache level filtering. The next 4 bits are ignored, and any cache or memory level is eligible.</p> <p>Ignored if no cache latency event is enabled or if the CPUID LwpCacheLevels bit is 0 to indicate that the implementation does not filter by cache level (use the MinLatency field to get a similar effect). At least one of these mechanisms is supported if any cache miss events are supported.</p>
9	NBC	<p>Northbridge cache events.</p> <p>1—Count cache-related events that are satisfied from data held in a cache that resides on the northbridge.</p> <p>0—Ignore northbridge cache events</p> <p>Ignored if CLF is 0.</p>
10	RDC	<p>Remote data cache events.</p> <p>1—Count cache-related events that are satisfied from data held in a remote data cache.</p> <p>0—Ignore remote cache events.</p> <p>Ignored if CLF is 0.</p>
11	RAM	<p>DRAM cache events.</p> <p>1—Count cache-related events that are satisfied from DRAM.</p> <p>0—Ignore DRAM cache events.</p> <p>Ignored if CLF is 0.</p>
12	OTH	<p>Other cache events.</p> <p>1—Count cache-related events that are satisfied from other sources, such as MMIO, Config space, PCI space, or APIC.</p> <p>0—Ignore such cache events</p> <p>Ignored if CLF is 0.</p>
24:13		Reserved



Table 13-9. LWPCB Filters Fields (continued)

Bits	Field	Description
25	NMB	<p>No mispredicted branches.</p> <p>1—Mispredicted branches will not be counted.</p> <p>0—Mispredicted branches will be counted if not suppressed by other filter conditions.</p> <p>Caution: If NMB and NPB are both set, no branches will be counted.</p> <p>Ignored if the Branches Retired event is not enabled or if the CPUID LwpBranchPrediction bit is 0 to indicate that the implementation does not filter by prediction.</p>
26	NPB	<p>No predicted branches.</p> <p>1—Correctly predicted branches will not be counted. Note that since direct branches are always predicted correctly, this is a superset of the NDB filter.</p> <p>0—Correctly predicted branches will be counted if not suppressed by other filter conditions.</p> <p>Caution: If NMB and NPB are both set, no branches will be counted.</p> <p>Ignored if the Branches Retired event is not enabled or if the CPUID LwpBranchPrediction bit is 0 to indicate that the implementation does not filter by prediction.</p>
27	NAB	<p>No absolute branches.</p> <p>1—Absolute branches will not be counted. This only applies to jumps through a register or memory (JMP opcode FF /4) and calls through a register or memory (CALL opcode FF /2). Relative branches (both conditional and unconditional) are counted normally if not disabled via the NRB or NCB bits.</p> <p>0—Absolute branches will be counted if not suppressed by other filter conditions.</p> <p>Caution: If NRB, NCB, and NAB are all set, no branches will be counted.</p> <p>Ignored if the Branches Retired event is not enabled.</p>
28	NCB	<p>No conditional branches.</p> <p>1—Conditional branches will not be counted. This only applies to conditional jumps (Jcc) and loops (LOOPcc). Unconditional relative branches, indirect jumps through a register or memory, and returns are counted normally if not disabled via the NRB or NAB bits.</p> <p>0—Conditional branches will be counted if not suppressed by other filter conditions.</p> <p>Caution: If NRB, NCB, and NAB are all set, no branches will be counted.</p> <p>Ignored if the Branches Retired event is not enabled.</p>

**Table 13-9. LWPCB Filters Fields (continued)**

Bits	Field	Description
29	NRB	<p>No unconditional relative branches.</p> <p>1—Unconditional relative branches will not be counted. This applies to unconditional jumps (JMP), calls (CALL), and returns (RET). Conditional branches and indirect jumps or calls through a register or memory are counted normally if not disabled via the NCB or NAB bits.</p> <p>0—Direct branches will be counted if not suppressed by other filter conditions.</p> <p>Caution: If NRB, NCB, and NAB are all set, no branches will be counted. Ignored if the Branches Retired event is not enabled.</p>
30	IPI	<p>IP filtering invert.</p> <p>1—IP filtering inverted. Only instructions outside the range from BaseIP to LimitIP are eligible for LWP counting.</p> <p>0—IP filtering normal. Only instructions inside the range from BaseIP to LimitIP are eligible for LWP counting.</p> <p>Ignored if IPF is zero or if the CPUID LwplpFiltering bit is 0 to indicate that IP filtering is not supported.</p>
31	IPF	<p>IP filtering.</p> <p>1—IP filtering enabled. The values of the BaseIP and LimitIP fields specify a range of instruction addresses that are eligible for LWP event counting and reporting. The range is inclusive if IPI is 0 and exclusive if IPI is 1.</p> <p>0—IP filtering disabled; instructions at every address are eligible for LWP counting.</p> <p>Ignored if the CPUID LwplpFiltering bit is 0 to indicate that IP filtering is not supported.</p>

### 13.4.7 XSAVE/XRSTOR

LWP requires that the processor support the XSAVE/XRSTOR instructions for managing extended processor state components.

#### 13.4.7.1 Configuration

The processor uses bit 62 of XFEATURE\_ENABLED\_MASK (register XCR0) to indicate whether LWP state can be saved and restored, and thus whether LWP is available to applications. The LWP XSAVE area length and offset from the beginning of the XSAVE area are available from the CPUID instruction (see “Detecting LWP XSAVE Area” on page 399). In Version 1 of LWP, the LWP XSAVE area is 128 (080h) bytes long and the offset is 832 (340h) bytes.

#### 13.4.7.2 XSAVE Area

Figure 13-33 below shows the layout of the XSAVE area for LWP. It is large enough to allow for future expansion of the number of event counters. Details of the fields are in Table 13-10.

All fields in the XSAVE area that are marked as “Reserved” (or “Rsvd”) must be zero.

Byte 7	Byte 06	Byte 5	Byte 4	Byte 3	Byte 2	Byte 1	Byte 0	
LWPCBAddress								0
BufferHeadOffset				Counter Flags (Reserved)			Cntr Flags	8
BufferBase								16
Filters				Rsvd	BufferSize			24
Saved Event Record								32
								40
								48
								56
EventCounter2				EventCounter1				64
EventCounter4				EventCounter3				72
EventCounter6				EventCounter5				80
Reserved for EventCounter8				Reserved for EventCounter7				88
Reserved for EventCounter10				Reserved for EventCounter9				96
Reserved for EventCounter12				Reserved for EventCounter11				104
Reserved for EventCounter14				Reserved for EventCounter13				112
Reserved for EventCounter16				Reserved for EventCounter15				120

**Figure 13-33. XSAVE Area for LWP**

**Table 13-10. XSAVE Area for LWP Fields**

Bytes	Bits	Field	Description
7–0		LWPCBAddress	Address of LWPCB. 0 if LWP is disabled, in which case the rest of the save area is ignored. This is a linear address.
9–8	0	—	Reserved
9–8	1	CntrFlags.Counter1	1—Event with EventId 1 is active. XRSTOR will make the event active and restore its counter from EventCounter1. 0—Event 1 is not active. XRSTOR will make the event inactive.
9–8	6:2	CntrFlags.Countern	Bit flags defined as above for EventCounter2–6.
9–8	15:7	—	Reserved for counter flags
11–10	15:0	—	Reserved for counter flags
15–12		BufferHeadOffset	BufferHeadOffset value
23–16		BufferBase	Address of the event ring buffer. This is a linear address.
27–24	27:0	BufferSize	Size of the event ring buffer
27–24	31:28	—	Reserved
31–28		Filters	Profiling filters (same as the Filters field in the LWPCB)
63–32		SavedEventRecord	If an event record is pending, the data to write. May be sparse. Zero in the EventId field means no record pending.
67–64		EventCounter1	Counter for event 1 (valid if CntrFlags.Counter1 bit is set)
87–68		EventCountern	Counters for events 2–6 (valid if the respective Countern bit is set)
127–88		—	Reserved for future event counters

### 13.4.7.3 XSAVE operation

If LWP is not currently enabled (i.e., if `LWP_CBADDR = 0`), no state needs to be stored. XSAVE sets bit 62 in `XSAVE.HEADER.XSTATE_BV` to 0 so that an attempt to restore state from this save area will use the processor supplied values. See “Processor supplied values” on page 422.

If LWP is enabled, XSAVE stores the various internal LWP values into the XSAVE area with no checking or conversion and sets bit 62 in `XSAVE.HEADER.XSTATE_BV` to 1.

### 13.4.7.4 XRSTOR operation

If bit 62 in `XFEATURE_ENABLED_MASK (XCR0)` is 0 or if bit 62 of `EDX:EAX (EDX[30])` is 0, XRSTOR does not alter the LWP state.

If the above bits are 1 but bit 62 in `XSAVE.HEADER.XSTATE_BV` is 0, XRSTOR writes the LWP state using the processor supplied values, disabling LWP. See “Processor supplied values” on page 422.

If all of the above bits are 1, XRSTOR loads LWP state from the XSAVE area as follows:

1. The internal pointers and sizes are loaded.

- If BufferSize is below the implementation minimum, LWP is disabled and XRSTOR of LWP state terminates.
  - If BufferSize is not a multiple of the event record size, it is rounded down.
  - If BufferHeadOffset is greater than (BufferSize - LwpEventSize), a value of 0 is used instead.
  - If BufferHeadOffset is not a multiple of the event record size, it is rounded down.
2. For each bit that is set in the Flags field that corresponds to an available event (as currently set in the LWP\_CFG MSR), the corresponding event is enabled and the event counter is loaded from the EventCounter $n$  field. All other events are disabled.
  3. If the EventId field in the SavedEventRecord is non-zero, there was a pending event when XSAVE was executed. XRSTOR loads the event record into hardware. LWP will store it into the event ring buffer as soon as possible once the CPL is 3.

Software should not alter the SavedEventRecord field. An implementation may ignore a saved event record if it was not constructed by XSAVE. Storing an event into SavedEventRecord and then executing XRSTOR is not a reliable way of injecting an event into the ring buffer.

Note that if LWP is already enabled when executing XRSTOR, the old LWP state is overwritten without being saved.

No interrupt is generated by XRSTOR if the restored value of BufferHeadOffset results in a buffer that is filled beyond the threshold. The interrupt will occur the next time an event record is stored.

XRSTOR may not restore all of the state necessary for LWP to operate. The LWP hardware will read additional state from the LWPCB when it stores then next event record.

If the CPL = 0, XRSTOR simply reloads the LWPCB address and the ring buffer address from the XSAVE area. Kernel software is trusted not to alter the area in such a way as to allow access to memory that the application could not otherwise read or write. The linear addresses in the XSAVE area were validated when the application executed LLWPCB.

If the CPL  $\neq$  0, XRSTOR first validates the LWPCB and ring buffer pointers. This prevents an application from altering the XSAVE area in order to gain access to memory that it could not otherwise read or write (based on the current values in the DS segment register). Note that if a program's DS value changes after doing a successful LLWPCB, it might be incapable of doing an XSAVE and then an XRSTOR of LWP state. The XRSTOR will fail if the new DS value no longer allows access to the linear addresses corresponding to the LWPCB or the ring buffer. Programs should avoid this behavior.

If XRSTOR is executed when the CPL  $\neq$  0, the system performs additional checks on the LWPCB and ring buffer addresses according to the pseudo-code below. A “Store-type Segment\_check” fails if the limit check fails (address is beyond the segment limit) or if the segment is read-only.

```
bool Check(uint64 addr, uint32 size) { // Utility function
    if (!64bit_Mode)
        addr = truncate32(addr - DS.BASE)
    uint64 top = addr + size - 1;
    if (! Store-type Segment_check on DS:[addr] || // Check lower bound
        ! Store-type Segment_check on DS:[top]) // and upper bound
```

```

        return false;
    return true;
}

if (! Check(XSAVE.LWPCBAddress, sizeof(LWPCB)) ||
    ! Check(XSAVE.BufferAddress, XSAVE.BufferSize))
    Disable LWP

```

If any of the address checks fails, LWP is disabled. No fault is generated. A program that executes XRSTOR when the CPL  $\neq$  0 and DS has changed can use SLWPCB to check whether LWP is running.

As with all features that use XSAVE and XRSTOR, if bit 62 of XFEATURE\_ENABLED\_MASK (XCR0) is 0 but bit 62 of XSAVE.HEADER.XSTATE\_BV is 1, XRSTOR will cause a #GP(0) exception.

#### 13.4.7.5 Processor supplied values

If XRSTOR is executed when bit 62 of XFEATURE\_ENABLED\_MASK (XCR0) and EDX:EAX are both 1, but the corresponding bit in XSAVE.HEADER.XSTATE\_BV is 0, it indicates that there is no LWP state to restore. In this case, LWP\_CBADDR is set to 0 and LWP is disabled. Other processor internal state for LWP is set to 0 as necessary to avoid security issues.

### 13.4.8 Implementation Notes

The following subsections describe other LWP considerations.

#### 13.4.8.1 Multiple Simultaneous Events

Multiple events are possible when an instruction retires. For instance, an indirect jump through a pointer in memory can trigger the instructions retired, branches retired, and DCache miss events simultaneously. LWP counts all events that apply to the instruction, but might not store event records for all events whose event counters became negative. It is implementation dependent as to how many event records are stored when multiple event counters simultaneously become negative. If not all events cause event records to be stored, the choice of which event(s) to report is implementation dependent and may vary from run to run on the same processor.

#### 13.4.8.2 Processor State for Context Switch, SVM, and SMM

Implementations of LWP have internal state to hold information such as the current values of the counters for the various events, a pointer into the event ring buffer, and a copy of the tail pointer for quick detection of threshold and overflow states.

There are times when the system must preserve the volatile LWP state. When the operating system context switches from one user thread to another, the old user state must be saved with the thread's context and the new state must be loaded. When a hypervisor decides to switch from one guest OS to another, the same must be done for the guest systems' states. Finally, state must be stored and reloaded when the system enters and exits SMM, since the SMM code may decide to shut off power to the core.

Hardware does not maintain the LWP state in the active LWPCB. This is because the counters change with every event (not just every reported event), so keeping them in memory would generate a large amount of unnecessary memory traffic. Also, the LWPCB is in user memory and may be paged out to disk at any time, so the memory may not be available when needed.

### **Saving State at Thread Context Switches**

LWP requires that an operating system use the XSAVE and XRSTOR instructions to save and restore LWP state across context switches.

XRSTOR restores the LWP volatile state when restoring other system state. Some additional LWP state will be restored from the LWPCB when operations in ring 3 require that information.

LWP does not support the “lazy” state save and restore that is possible for floating point and SSE state. It does not interact with the CR0[TS] bit. Operating systems that support LWP must always do an XSAVE to preserve the old thread’s LWP context and an XRSTOR to set up the new LWP context. The OS can continue to do a lazy switch of the FP and SSE state by ensuring that the corresponding bits in EDX:EAX are clear when it executes the XSAVE and XRSTOR to handle the LWP context.

### **Saving State at SVM Worldswitch to a Different Guest**

Hypervisors that allow guests to use LWP must save and restore LWP state when the guest OS changes. In addition to the usual information in the VMCB, the hypervisor must use XSAVE/XRSTOR to maintain the volatile LWP state and must also save and restore LWP\_CFG. When switching between a guest that uses LWP and one that does not, the hypervisor changes the value of XFEATURE\_ENABLED\_MASK (XCR0), which ensures that LWP is only enabled in the appropriate guest(s).

A hypervisor need not modify the LWP state if the guest OS is not changed.

### **Enabling SVM Live Migration**

Some hypervisors support live migration of a guest virtual machine. Live migration is when a hypervisor preserves the entire state of the guest running on one physical machine, copies that state to another physical machine, and then resumes execution of the guest on the new hardware.

To allow live migration among machines which may have different internal implementations of LWP, the hypervisor must present the common subset of features among all the hosts in the pool of machines that can be used. Furthermore, since the hypervisor may XSAVE LWP state on one machine and XRSTOR it on another machine, the contents of the XSAVE area must be consistent across all implementations.

This means that an implementation of LWP keeps all event counters internally, not in the LWPCB. If implementations were permitted to differ in this detail, a counter might not get properly restored after migrating the guest machine.

## Saving State at SMM Entry and Exit

SMM entry and exit must save and restore LWP state when the processor is going to change power state. SMM must use XSAVE/XRSTOR and must also save and restore LWP\_CFG. Since LWP is ring 3 only and is inactive in System Management Mode, its state should not need to be saved and restored otherwise.

## Notes on Restoring LWP State

The LWPCB may not be in memory at all times. Therefore, the LWP hardware does not attempt to access it while still in the OS kernel/VMM/SMM, since that access might fault. Some LWP state is restored once the processor is in ring 3 and can take a #PF exception without crashing. This usually happens the next time LWP needs to store an event record into the ring buffer.

### 13.4.8.3 LWPCB Access

Several LWPCB fields are written asynchronously by the LWP hardware and by the user software. This section discusses techniques for reducing the associated memory traffic. This is interesting to software because it influences what state is kept internally in LWP, and it explains the protocol between the hardware filling the event ring buffer and the software emptying it.

The hardware keeps an internal copy of the event ring buffer head pointer. It need not flush the head pointer to the LWPCB every time it stores an event record. The flush can be done periodically or it can be deferred until a threshold or buffer full condition happens or until the application executes LLWPCB or SLWPCB. Exceeding the buffer threshold always forces the head pointer to memory so that the interrupt handler emptying the ring buffer sees the threshold condition.

The hardware may keep an internal copy of the event ring buffer tail pointer. It need not read the software-maintained tail pointer unless it detects a threshold or buffer full condition. At that point, it rereads the tail pointer to see if software has emptied some records from the ring buffer. If so, it recomputes the condition and acts accordingly. This implies that software polling the ring buffer should begin processing event records when it detects a threshold condition itself. To avoid a race condition with software, the hardware rereads the tail pointer every time it stores an event record while the threshold condition appears to be true. (An implementation can relax this to “every  $n^{\text{th}}$  time” for some small value of  $n$ .) It also rereads it whenever the ring buffer appears to be full.

The interval values used to reset the counters can be cached in the hardware when the LLWPCB instruction is executed, or they can be read from the LWPCB each time the counter overflows.

The ring buffer base and size are cached in the hardware.

The MissedEvents value is a counter for an exceptional condition and is kept in memory.

The cached LWP state is refreshed from the LWPCB when LWP is enabled either explicitly via LLWPCB or implicitly when needed in ring 3 after LWP state is restored via XRSTOR.

Caching implies that software cannot reliably change sampling intervals or other cached state by modifying the LWPCB. The change might not be noticed by the LWP hardware. On the other hand, changing state in the LWPCB while LWP is running may change the operation at an unpredictable



moment in the future if LWP context is saved and restored due to context switching. Software must stop and restart LWP to ensure that any changes reliably take effect.

#### 13.4.8.4 Security

The operating system must ensure that information does not leak from one process to another or from the kernel to a user process. Hence, if it supports LWP at all, the operating system must ensure that the state of the LWP hardware is set appropriately when a context switch occurs and when a new process or thread is created. LWP state for a new thread can be initialized by executing XRSTOR with bit 62 of XSAVE.HEADER.XSTATE\_BV set to 0 and the corresponding bit in EDX:EAX set to 1.

#### 13.4.8.5 Interrupts

The LWP threshold interrupt vector number is specified in the LWP\_CFG MSR. The operating system must assign a vector for LWP threshold interrupts and fill in the corresponding entry in the interrupt-descriptor table. Note that the LWP interrupt is not shared with the performance counter interrupt, since the system allows concurrent and independent use of those two mechanisms.

#### 13.4.8.6 Memory Access During LWP Operation

When LWP needs to save an event record in the event ring buffer, it accesses the user memory containing the ring buffer and sometimes the memory containing the LWPCB. This causes a Page Fault (#PF) exception if those pages are not in memory.

A particular implementation of LWP has several ways to deal with page faults when storing an event record. These may include saving the event record in the XSAVE area and retrying the store later, reexecuting the instruction, or discarding the event and reporting the next event of the appropriate type.

Note that this reinforces the notion that LWP is a sampling mechanism. Programs cannot rely on it to precisely capture every  $n^{\text{th}}$  instance of an event. It captures *approximately* every  $n^{\text{th}}$  instance.

#### 13.4.8.7 Guidelines for Operating Systems

To support LWP, an operating system should follow the following guidelines. Most of these operations should be done on each core of a multi-core system.

##### System initialization

1. Use CPUID Fn0000\_0000 to ensure that the system is running on an “Authentic AMD” processor, and then check CPUID Fn8000\_0001\_ECX[LWP] to ensure that the processor supports LWP.

Alternatively, check CPUID Fn0000\_000D\_EDX\_x0[30] to ensure that the system supports the LWP XSAVE area, indicating that the processor supports LWP.

2. Enable XSAVE operations by setting CR4[OSXSAVE].
3. Enable LWP by executing XSETBV to set bit 62 of XCR0.

4. Assign a unique interrupt vector number for LWP threshold interrupts and load the corresponding entry in the interrupt-descriptor table with the address of the interrupt handler. This handler should use some system-specific method to forward any threshold interrupts to the application.
5. Make LWP available by setting LWP\_CFG. To enable all supported LWP features, set LWP\_CFG[31:0] to the value returned by CPUID Fn8000\_001C\_EDX. Set LWP\_CFG[COREID] to the APIC core number (or some other value unique to the core) and LWP\_CFG[VECTOR] to the assigned interrupt vector number.

### Thread support

- For each thread, allocate an XSAVE area that is at least as big as the XFeatureEnabledSizeMax value returned by CPUID Fn0000\_000D\_EBX\_x0 (ECX=0). This is good practice for any system that supports XSAVE.
- When creating a new process or thread, execute XRSTOR with bit 62 of EDX:EAX set to 1 and bit 62 of XSAVE.HEADER.XSTATE\_BV set to 0. This ensures that LWP is turned off for any new thread. Alternatively, use WRMSR to write 0 into LWP\_CBADDR before starting the thread.
- When saving a running thread's context, execute XSAVE with bit 62 of EDX:EAX set to 1 to save the thread's LWP state. It takes almost no time or resources if the thread is not using LWP.
- When restoring a thread's context, execute XRSTOR with bit 62 of EDX:EAX set to 1. This restores the LWP state for the thread or disables LWP if the thread is not using it.
- When a thread exits or aborts, use WRMSR to store 0 into LWP\_CBADDR. This ensures that LWP is turned off.

### 13.4.8.8 Summary of LWP State

LWP adds the following visible state to the AMD64 architecture:

- CPUID Fn8000\_0001\_ECX[LWP] (bit 15) to indicate LWP support.
- CPUID Fn8000\_001C to indicate LWP features.
- Two new MSRs: LWP\_CFG, LWP\_CBADDR,.
- Four new instructions: LLWPCB, SLWPCB, LWPINS, and LWPVAL.
- Bit 62 in XCR0 (XFEATURE\_ENABLED\_MASK)
- A new XSAVE area for LWP state.
- New fields for LWP state in the SVM and SMM context, whether in the VMCB and SMM save area or elsewhere.

See Section 3.3, “Processor Feature Identification,” on page 63 for information on using the CPUID instruction to obtain information about processor capabilities.

## 14 Processor Initialization and Long Mode Activation

---

This chapter describes the hardware actions taken following a processor reset and the steps that must be taken to initialize processor resources and activate long mode. In some cases the actions required are implementation-specific with references made to the appropriate implementation-specific documentation.

### 14.1 Processor Initialization

System logic can initialize the processor in either of two ways. One method, called RESET, is usually initiated by the assertion of an external signal (typically designated RESET#). The other method, called INIT, is typically initiated by another processor by means of an INIT interprocessor interrupt (IPI). See “Interprocessor Interrupts (IPI)” on page 545 for more information.

Both initialization techniques place the processor in real mode and initialize processor resources to a known, consistent state from which software can begin execution. The processor begins execution when the RESET# pin is deasserted or the INIT state is exited.

The RESET method places the processor in a known state and prepares it to begin execution in real mode. The INIT method is similar except it does not modify the state of certain registers. See Section 14.1.3 on page 428 for a comparison of these initialization methods.

System logic ensures that the processor transitions through the RESET state whenever power is reapplied after a planned or unplanned interruption. A RESET can also be performed when power is stable. An INIT can be performed at any time after the processor is powered up.

#### 14.1.1 Built-In Self Test (BIST)

An optional built-in self-test can be performed after the processor is reset. The mechanism for triggering the BIST is implementation-specific, and can be found in the hardware documentation for the implementation. The number of processor cycles BIST can consume before completing is also implementation-specific but typically consumes several million cycles.

BIST can be used by system implementations to assist in verifying system integrity, thereby improving system reliability, availability, and serviceability. The internal BIST hardware generally tests all internal array structures for errors. These structures can include (but are not limited to):

- All internal caches, including the tag arrays as well as the data arrays.
- All TLBs.
- Internal ROMs, such as the microcode ROM and floating-point constant ROM.
- Branch-prediction structures.

EAX is loaded with zero if BIST completes without detecting errors. If any hardware faults are detected during BIST, a non-zero value is loaded into EAX.

**14.1.2 Clock Multiplier Selection**

The internal processor clock runs at some multiple of the system clock. The processor-to-system clock multiple does not have to be fixed by a processor implementation but instead can be programmable through hardware or software, or some combination of the two. For information on selecting the processor-clock multiplier, see the *BIOS and Kernel Developer’s Guide* applicable to your product.

**14.1.3 Processor Initialization State**

Table 14-1 shows the initial processor state following either RESET or INIT. Except as indicated, processor resources generally are set to the same value after either RESET or INIT.

**Table 14-1. Initial Processor State**

Processor Resource	Value After RESET	Value After INIT
CR0	0000_0000_6000_0010h	CD and NW are unchanged Bit 4 (reserved) = 1 All others = 0
CR2, CR3, CR4	0	
CR8	0	Not modified
RFLAGS	0000_0000_0000_0002h	
EFER	0	
RIP	0000_0000_0000_FFF0h	
CS	Selector = F000h Base = 0000_0000_FFFF_0000h Limit = FFFFh Attributes = See Table 14-2 on page 430	
DS, ES, FS, GS, SS	Selector = 0000h Base = 0 Limit = FFFFh Attributes = See Table 14-2 on page 430	
GDTR, IDTR	Base = 0 Limit = FFFFh	
LDTR, TR	Selector = 0000h Base = 0 Limit = FFFFh Attributes = See Table 14-2 on page 430	
RAX	0 (non-zero if BIST is run and fails)	0

**Table 14-1. Initial Processor State (continued)**

Processor Resource	Value After RESET	Value After INIT
RDX	Family/Model/Stepping, including extended family and extended model—see “Processor Implementation Information” on page 431	
RBX, RCX, RBP, RSP, RDI, RSI, R8, R9, R10, R11, R12, R13, R14, R15	0	
x87 Floating-Point State	FPR0–FPR7 = 0 Control Word = 0040h Status Word = 0000h Tag Word = 5555h Instruction CS = 0000h Instruction Offset = 0 x87 Instruction Opcode = 0 Data-Operand DS = 0000h Data-Operand Offset = 0	Not modified
64-Bit Media State	MMX0–MMX7 = 0	Not modified
SSE State	XMM0–XMM15 = 0 MXCSR = 1F80h	Not modified
Memory-Type Range Registers	See “Memory-Typing MSRs” on page 572	Not modified
Machine-Check Registers	See “Machine-Check MSRs” on page 574	Not modified
DR0, DR1, DR2, DR3	0	
DR6	0000_0000_FFFF_0FF0h	
DR7	0000_0000_0000_0400h	
Time-Stamp Counter	0	Not modified
Performance-Monitor Resources	See “Performance-Monitoring MSRs” on page 576	Not modified
Other Model-Specific Registers	See “MSR Cross-Reference” on page 567	Not modified
Instruction and Data Caches	Invalidated	Not modified
Instruction and Data TLBs		
APIC	Enabled	Not modified
SMRAM Base Address (SMBASE)	0003_0000h	Not modified

Table 14-2 on page 430 shows the initial state of the segment-register attributes (located in the hidden portion of the segment registers) following either RESET or INIT.

**Table 14-2. Initial State of Segment-Register Attributes**

Attribute		Value (Binary)	Description
G		0	Byte Granularity
D/B		0	16-Bit Segment
L (CS Only)		0	Legacy-Mode Segment
P		1	Segment is Present
DPL		00	Privilege-Level 0
S and Type	Code Segment	S = 1 Type = 1010	Executable/Readable Code Segment
	Data Segment	S = 1 Type = 0010	Read/Write Data Segment
	LDTR	S = 0 Type = 0010	LDT
	TR	S = 0 Type = 0011	Busy 16-Bit TSS

#### 14.1.4 Multiple Processor Initialization

Following reset in multiprocessor configurations, the processors use a multiple-processor initialization protocol to negotiate which processor becomes the *bootstrap* processor. This bootstrap processor then executes the system initialization code while the remaining processors wait for software initialization to complete. For further information, see the documentation for particular implementations of the architecture.

#### 14.1.5 Fetching the First Instruction

After a RESET or INIT, the processor is operating in 16-bit real mode. Normally within real mode, the code-segment base-address is formed by shifting the CS-selector value left four bits. The base address is then added to the value in EIP to form the physical address into memory. As a result, the processor can only address the first 1 Mbyte of memory when in real mode.

However, immediately following RESET or INIT, the CS-selector register is loaded with F000h, but the CS base-address is *not* formed by left-shifting the selector. Instead, the CS base-address is initialized to FFFF\_0000h. EIP is initialized to FFF0h. Therefore, the first instruction fetched from memory is located at physical-address FFFF\_FFF0h (FFFF\_0000h + 0000\_FFF0h).

The CS base-address remains at this initial value until the CS-selector register is loaded by software. This can occur as a result of executing a far jump instruction or call instruction, for example. When CS is loaded by software, the new base-address value is established as defined for real mode (by left shifting the selector value four bits).

## 14.2 Hardware Configuration

### 14.2.1 Processor Implementation Information

Software can read processor-identification information from the EDX register immediately following RESET or INIT. This information can be used to initialize software to perform processor-specific functions. The information stored in EDX is defined as follows:

- *Stepping ID (bits 3:0)*—This field identifies the processor-revision level.
- *Extended Model (bits 19:16) and Model (bits 7:4)*—These fields combine to differentiate processor models within a instruction family. For example, two processors may share the same microarchitecture but differ in their feature set. Such processors are considered different models within the same instruction family. This is a split field, comprising an extended-model portion in bits 19:16 with a legacy portion in bits 7:4
- *Extended Family (bits 27:20) and Family (bits 11:8)*—These fields combine to differentiate processors by their microarchitecture.

The CPUID instruction can be used to obtain the same information. This is done by executing CPUID with either function 1 or function 8000\_0001h. Additional information about the processor and the features supported can be gathered using CPUID with other feature codes. See Section 3.3, “Processor Feature Identification,” on page 63 for additional information.

### 14.2.2 Enabling Internal Caches

Following a RESET (but not an INIT), all instruction and data caches are disabled, and their contents are invalidated (the MOESI state is set to the invalid state). Software can enable these caches by clearing the cache-disable bit (CR0.CD) to zero (RESET sets this bit to 1). Software can further refine caching based on individual pages and memory regions. Refer to “Cache Control Mechanisms” on page 182 for more information on cache control.

**Memory-Type Range Registers (MTRRs).** Following a RESET (but not an INIT), the MTRRdefType register is cleared to 0, which disables the MTRR mechanism. The variable-range and fixed-range MTRR registers are not initialized and are therefore in an undefined state. Before enabling the MTRR mechanism, the initialization software (usually platform firmware) must load these registers with a known value to prevent unexpected results. Clearing these registers, for example, sets memory to the uncacheable (UC) type.

### 14.2.3 Initializing Media and x87 Processor State

Some resources used by x87 floating-point instructions and media instructions must be initialized by software before being used. Initialization software can use the CPUID instruction to determine whether the processor supports these instructions, and then initialize their resources as appropriate.

**x87 Floating-Point State Initialization.** Table 14-3 on page 432 shows the differences between the initial x87 floating-point state following a RESET and the state established by the FINIT/FNINIT instruction. An INIT does not modify the x87 floating-point state. The initialization software can

execute an FINIT or FNINIT instruction to prepare the x87 floating-point unit for use by application software. The FINIT and FNINIT instructions have no effect on the 64-bit media state.

**Table 14-3. x87 Floating-Point State Initialization**

x87 Floating-Point Resource	RESET	FINIT/FNINIT Instructions
FPR0–FPR7	0	Not modified
Control Word	0040h <ul style="list-style-type: none"> <li>• Round to nearest</li> <li>• Single precision</li> <li>• Unmask all exceptions</li> </ul>	037Fh <ul style="list-style-type: none"> <li>• Round to nearest</li> <li>• Extended precision</li> <li>• Mask all exceptions</li> </ul>
Status Word	0000h	
Tag Word	5555h (FPR $n$ contain zero)	FFFFh (FPR $n$ are empty)
Instruction CS	0000h	
Instruction Offset	0	
x87 Instruction Opcode	0	
Data-Operand DS	0000h	
Data-Operand Offset	0	

Initialization software should also load the MP, EM, and NE bits in the CR0 register as appropriate for the operating system. The recommended settings for implementations of the AMD64 architecture are:

- *MP=1*—Setting MP to 1 causes a device-not-available exception (#NM) to occur when the FWAIT/WAIT instruction is executed and the task-switched bit (CR0.TS) is set to 1. This supports operating systems that perform lazy context-switching of x87 floating-point state.
- *EM=0*—Clearing EM to 0 allows the x87 floating-point unit to execute instructions rather than causing a #NM exception (CR0.EM=1). System software sets EM to 1 only when software emulation of x87 instructions is desired.
- *NE=1*—Setting NE to 1 causes x87 floating-point exceptions to be handled by the floating-point exception-pending exception (#MF) handler. Clearing this bit causes the processor to externally indicate the exception occurred, and an external device can then cause an external interrupt to occur in response.

Refer to “CR0 Register” on page 42 for additional information on these control bits.

**64-Bit Media State Initialization.** There are no special requirements placed on software to initialize the processor state used by 64-bit media instructions. This state is initialized completely by the processor following a RESET. System software should leave CR0.EM cleared to 0 to allow execution of the 64-bit media instructions. If CR0.EM is set to 1, attempted execution of the 64-bit media instructions causes an invalid-opcode exception (#UD).

The 64-bit media state is not modified by an INIT.



**SSE State Initialization.** Platform firmware or system software must also prepare the processor to allow execution of SSE instructions. The required preparations include:

- Leaving CR0.EM cleared to 0 to allow execution of the SSE instructions. If CR0.EM is set to 1, attempted execution of the SSE instructions except FXSAVE/FXRSTOR causes an invalid-opcode exception (#UD). An attempt to execute either of these instructions when CR0.EM is set results in a #NM exception.
- Enabling the SSE instructions by setting CR4.OSFXSR to 1. Software cannot execute the SSE instructions unless this bit is set. Setting this bit also indicates that system software uses the FXSAVE and FXRSTOR instructions to save and restore, respectively, the SSE state. These instructions also save and restore the 64-bit media state and x87 floating-point state.
- Indicating that system software uses the SIMD floating-point exception (#XF) for handling SSE floating-point exceptions. This is done by setting CR4.OSXMMEXCPT to 1.
- Setting (optionally) the MXCSR mask bits to mask or unmask SSE floating-point exceptions as desired. Because this register can be read and written by application software, it is not absolutely necessary for system software to initialize it.

Refer to “CR4 Register” on page 47 for additional information on these CR4 control bits.

#### 14.2.4 Model-Specific Initialization

Implementations of the AMD64 architecture can contain model-specific features and registers that are not initialized by the processor and therefore require system-software initialization. System software must use the CPUID instruction to determine which features are supported. Model-specific features are generally configured using model-specific registers (MSRs), which can be read and written using the RDMSR and WRMSR instructions, respectively.

Some of the model-specific features are pervasive across many processor implementations of the AMD64 architecture and are therefore described within this volume. These include:

- System-call extensions, which must be enabled in the EFER register before using the SYSCALL and SYSRET instructions. See “System-Call Extension (SCE) Bit” on page 56 for information on enabling these instructions.
- Memory-typing MSRs. See “Memory-Type Range Registers (MTRRs)” on page 431 for information on initializing and using these registers.
- The machine-check mechanism. See “Initializing the Machine-Check Mechanism” on page 277 for information on enabling and using this capability.
- Extensions to the debug mechanism. See “Software-Debug Resources” on page 348 for information on initializing and using these extensions.
- The performance-monitoring resources. See “Performance Monitoring Counters” on page 362 for information on initializing and using these resources.

Initialization of other model-specific features used by the page-translation mechanism and long mode are described throughout the remainder of this section.

Some model-specific features are not pervasive across processor implementations and are therefore not described in this volume. For more information on these features and their initialization requirements, see the *BIOS and Kernel Developer's Guide* applicable to your product.

## 14.3 Initializing Real Mode

A basic real-mode (real-address-mode) operating environment must be initialized so that system software can initialize the protected-mode operating environment. This real-mode environment must include:

- A real-mode IDT for vectoring interrupts and exceptions to the appropriate handlers while in real mode. The IDT base-address value in the IDTR initialized by the processor can be used, or system software can relocate the IDT by loading a new base-address into the IDTR.
- The real-mode interrupt and exception handlers. These must be loaded before enabling external interrupts.

Because the processor can always accept a non-maskable interrupt (NMI), it is possible an NMI can occur before initializing the IDT or the NMI handler. System hardware must provide a mechanism for disabling NMIs to allow time for the IDT and NMI handler to be properly initialized. Alternatively, the IDT and NMI handler can be stored in non-volatile memory that is referenced by the initial values loaded into the IDTR.

Maskable interrupts can be enabled by setting EFLAGS.IF after the real-mode IDT and interrupt handlers are initialized.

- A valid stack pointer (SS:SP) to be used by the interrupt mechanism should interrupts or exceptions occur. The values of SS:SP initialized by the processor can be used.
- One or more data-segment selectors for storing the protected-mode data structures that are created in real mode.

Once the real-mode environment is established, software can begin initializing the protected-mode environment.

## 14.4 Initializing Protected Mode

Protected mode must be entered before activating long mode. A minimal protected-mode environment must be established to allow long-mode initialization to take place. This environment must include the following:

- A protected-mode IDT for vectoring interrupts and exceptions to the appropriate handlers while in protected mode.
- The protected-mode interrupt and exception handlers referenced by the IDT. Gate descriptors for each handler must be loaded in the IDT.
- A GDT which contains:
  - A code descriptor for the code segment that is executed in protected mode.

- A read/write data segment that can be used as a protected-mode stack. This stack can be used by the interrupt mechanism if interrupts or exceptions occur.

Software can optionally load the GDT with one or more data segment descriptors, a TSS descriptor, and an LDT descriptor for use by long-mode initialization software.

After the protected-mode data structures are initialized, system software must load the IDTR and GDTR (and optionally, the LDTR and TR) with pointers to those data structures. Once these registers are initialized, protected mode can be enabled by setting CR0.PE to 1.

If legacy paging is used during the long-mode initialization process, the page-translation tables must be initialized before enabling paging. At a minimum, one page directory and one page table are required to support page translation. The CR3 register must be loaded with the starting physical address of the highest-level table supported in the page-translation hierarchy. After these structures are initialized and protected mode is enabled, paging can be enabled by setting CR0.PG to 1.

## 14.5 Initializing Long Mode

From protected mode, system software can initialize the data structures required by long mode and store them anywhere in the first 4 Gbytes of physical memory. These data structures can be relocated above 4 Gbytes once long mode is activated. The data structures required by long mode include the following:

- An IDT with 64-bit interrupt-gate descriptors. Long-mode interrupts are always taken in 64-bit mode, and the 64-bit gate descriptors are used to transfer control to interrupt handlers running in 64-bit mode. See “Long-Mode Interrupt Control Transfers” on page 247 for more information.
- The 64-bit mode interrupt and exception handlers to be used in 64-bit mode. Gate descriptors for each handler must be loaded in the 64-bit IDT.
- A GDT containing segment descriptors for software running in 64-bit mode and compatibility mode, including:
  - Any LDT descriptors required by the operating system or application software.
  - A TSS descriptor for the single 64-bit TSS required by long mode.
  - Code descriptors for the code segments that are executed in long mode. The code-segment descriptors are used to specify whether the processor is operating in 64-bit mode or compatibility mode. See “Code-Segment Descriptors” on page 88, “Long (L) Attribute Bit” on page 89, and “CS Register” on page 71 for more information.
  - Data-segment descriptors for software running in compatibility mode. The DS, ES, and SS segments are ignored in 64-bit mode. See “Data-Segment Descriptors” on page 89 for more information.
  - FS and GS data-segment descriptors for 64-bit mode, if required by the operating system. If these segments are used in 64-bit mode, system software can also initialize the full 64-bit base addresses using the WRMSR instruction. See “FS and GS Registers in 64-Bit Mode” on page 72 for more information.

The existing protected-mode GDT can be used to hold the long-mode descriptors described above.

- A single 64-bit TSS for holding the privilege-level 0, 1, and 2 stack pointers, the interrupt-stack-table pointers, and the I/O-redirection-bitmap base address (if required). This is the only TSS required, because hardware task-switching is not supported in long mode. See “64-Bit Task State Segment” on page 337 for more information.
- The 4-level page-translation tables required by long mode. Long mode also requires the use of physical-address extensions (PAE) to support physical-address sizes greater than 32 bits. See “Long-Mode Page Translation” on page 130 for more information.

If paging is enabled during the initialization process, it *must* be disabled before enabling long mode. After the long-mode data structures are initialized, and paging is disabled, software can enable and activate long mode.

## 14.6 Enabling and Activating Long Mode

Long mode is *enabled* by setting the long-mode enable control bit (EFER.LME) to 1. However, long mode is not *activated* until software also enables paging. When software enables paging while long mode is enabled, the processor activates long mode, which the processor indicates by setting the long-mode-active status bit (EFER.LMA) to 1. The processor behaves as a 32-bit x86 processor in all respects until long mode is activated, even if long mode is enabled. None of the new 64-bit data sizes, addressing, or system aspects available in long mode can be used until EFER.LMA=1.

Table 14-4 shows the control-bit settings for enabling and activating the various operating modes of the AMD64 architecture. The default address and data sizes are shown for each mode. For the methods of overriding these default address and data sizes, see “Instruction Prefixes” in Volume 1.

**Table 14-4. Processor Operating Modes**

Mode		Encoding			Default Address Size (bits) <sup>2</sup>	Default Data Size (bits) <sup>2</sup>
		EFER.LMA <sup>1</sup>	CS.L	CS.D		
Long Mode	64-Bit Mode	1	1	0	64	32
	Compatibility Mode		0	1	32	32
				0	16	16
Legacy Mode		0	x	1	32	32
				0	16	16

**Note:**

1. EFER.LMA is set by the processor when software sets EFER.LME and CR0.PG according to the sequence described in “Activating Long Mode” on page 437.
2. See “Instruction Prefixes” in Volume 1 for overrides to default sizes.

Long mode uses two code-segment-descriptor bits, CS.L and CS.D, to control the operating submodes. If long mode is active, CS.L = 1, and CS.D = 0, the processor is running in 64-bit mode, as shown in Table 14-4 on page 436. With this encoding (CS.L=1, CS.D=0), default operand size is 32 bits and default address size is 64 bits. Using instruction prefixes, the default operand size can be overridden to 64 bits or 16 bits, and the default address size can be overridden to 32 bits.

The final encoding of CS.L and CS.D in long mode (CS.L=1, CS.D=1) is reserved for future use.

When long mode is active and CS.L is cleared to 0, the processor is in compatibility mode, as shown in Table 14-4 on page 436. In compatibility mode, CS.D controls default operand and address sizes exactly as it does in the legacy x86 architecture. Setting CS.D to 1 specifies default operand and address sizes as 32 bits. Clearing CS.D to 0 specifies default operand and address sizes as 16 bits.

### 14.6.1 Activating Long Mode

Switching the processor to long mode requires several steps. In general, the sequence involves disabling paging (CR0.PG=0), enabling physical-address extensions (CR4.PAE=1), loading CR3, enabling long mode (EFER.LME=1), and finally enabling paging (CR0.PG=1).

Specifically, software must follow this sequence to activate long mode:

1. If starting from page-enabled protected mode, disable paging by clearing CR0.PG to 0. This requires that the MOV CR0 instruction used to disable paging be located in an identity-mapped page (virtual address equals physical address).
2. In any order:
  - Enable physical-address extensions by setting CR4.PAE to 1. Long mode requires the use of physical-address extensions (PAE) in order to support physical-address sizes greater than 32 bits. Physical-address extensions must be enabled before enabling paging.
  - Load CR3 with the physical base-address of the level-4 page-map-table (PML4). See “Long-Mode Page Translation” on page 130 for details on creating the 4-level page translation tables required by long mode.
  - Enable long mode by setting EFER.LME to 1.
3. Enable paging by setting CR0.PG to 1. This causes the processor to set the EFER.LMA bit to 1. The instruction following the MOV CR0 that enables paging must be a branch, and both the MOV CR0 and the following branch instruction must be located in an identity-mapped page.

### 14.6.2 Consistency Checks

The processor performs long-mode consistency checks whenever software attempts to modify any of the control bits directly involved in activating long mode (EFER.LME, CR0.PG, and CR4.PAE). A general-protection exception (#GP) occurs when a consistency check fails. Long-mode consistency checks ensure that the processor does not enter an undefined mode or state that results in unpredictable behavior.

Long-mode consistency checks cause a general-protection exception (#GP) to occur if:

- An attempt is made to enable or disable long mode while paging is enabled.
- Long mode is enabled, and an attempt is made to enable paging before enabling physical-address extensions (PAE).
- Long mode is enabled, and an attempt is made to enable paging while CS.L=1.
- Long mode is active and an attempt is made to disable physical-address extensions (PAE).

Table 14-5 summarizes the long-mode consistency checks made during control-bit transitions.

**Table 14-5. Long-Mode Consistency Checks**

Control Bit	Transition	Check
EFER.LME	0 → 1	If (CR0.PG=1) then #GP(0)
	1 → 0	If (CR0.PG=1) then #GP(0)
CR0.PG	0 → 1	If ((EFER.LME=1) & (CR4.PAE=0) then #GP(0) If ((EFER.LME=1) & (CS.L=1)) then #GP(0)
CR4.PAE	1 → 0	If (EFER.LMA=1) then #GP(0)

### 14.6.3 Updating System Descriptor Table References

Immediately after activating long mode, the system-descriptor-table registers (GDTR, LDTR, IDTR, TR) continue to reference legacy descriptor tables. The tables referenced by these descriptors all reside in the lower 4 Gbytes of virtual-address space. After activating long mode, 64-bit operating-system software should use the LGDT, LLDT, LIDT, and LTR instructions to load the system descriptor-table registers with references to the 64-bit versions of the descriptor tables. See “Descriptor Tables” on page 73 for details on descriptor tables in long mode.

Long mode requires 64-bit interrupt-gate descriptors to be stored in the interrupt-descriptor table (IDT). Software must not allow exceptions or interrupts to occur between the time long mode is activated and the subsequent update of the interrupt-descriptor-table register (IDTR) that establishes a reference to the 64-bit IDT. This is because the IDTR continues to reference a 32-bit IDT immediately after long mode is activated. If an interrupt or exception occurred before updating the IDTR, a legacy 32-bit interrupt gate would be referenced and interpreted as a 64-bit interrupt gate, with unpredictable results.

External interrupts can be disabled using the CLI instruction. Non-maskable interrupts (NMI) and system-management interrupts (SMI) must be disabled using external hardware. See “Long-Mode Interrupt Control Transfers” on page 247 for more information on long mode interrupts.

### 14.6.4 Relocating Page-Translation Tables

The long-mode page-translation tables must be located in the first 4 Gbytes of physical-address space before activating long mode. This is necessary because the MOV CR3 instruction used to initialize the page-map level-4 base address must be executed in legacy mode before activating long mode. Because the MOV CR3 is executed in legacy mode, only the low 32 bits of the register are written, which limits the location of the page-map level-4 translation table to the low 4 Gbytes of memory. Software can







```

    mov    eax, 000000011h
    mov    cr0, eax
;
; Execute a far jump to turn protected mode on.
; code16_sel must point to the previously-established 16-bit
; code descriptor located in the GDT (for the code currently
; being executed).
;
    db    0eah                ;Far jump...
    dw    offset now_in_prot;to offset...
    dw    code16_sel          ;in current code segment.
;
; At this point we are in 16-bit protected mode, but long
; mode is still disabled.
;
;
now_in_prot:
;
; Set up the protected-mode stack pointer, SS:ESP.
; Stack_sel must point to the previously-established stack
; descriptor (read/write data segment), located in the GDT.
; Skip setting DS/ES/FS/GS, because we are jumping right to
; 64-bit code.
;
    mov    ax, stack_sel
    mov    ss, ax
    mov    esp, esp0
;
; Enable the 64-bit page-translation-table entries by
; setting CR4.PAE=1 (this is required before activating
; long mode). Paging is not enabled until after long mode
; is enabled.
;
    mov    eax, cr4
    bts    eax, 5
    mov    cr4, eax
;
; Create the long-mode page tables, and initialize the
; 64-bit CR3 (page-table base address) to point to the base
; of the PML4 page table. The PML4 page table must be located
; below 4 Gbytes because only 32 bits of CR3 are loaded when
; the processor is not in 64-bit mode.
;
    mov    eax, pml4_base ; Pointer to PML4 table (<4GB).
    mov    cr3, eax      ; Initialize CR3 with PML4 base.
;
; Enable long mode (set EFER.LME=1).
;
    mov    ecx, 0c0000080h ; EFER MSR number.
    rdmsr                                ; Read EFER.
    bts    eax, 8                ; Set LME=1.

```



```

; Load the 64-bit IDT. This is _required_, because the 64-bit
; IDT uses 64-bit interrupt descriptors, while the 32-bit
; IDT used 32-bit interrupt descriptors. pIDT64_linear is
; the _linear_ address of the 10-byte IDT pseudo-descriptor.
;
    lidt [pIDT64_linear]
;
; Set the current TSS. tss_sel should point to a 64-bit TSS
; descriptor in the current GDT. The TSS is used for
; inner-level stack pointers and the IO bit-map.
;
    mov    ax, tss_sel
    ltr    ax
;
; Set the current LDT. ldt_sel should point to a 64-bit LDT
; descriptor in the current GDT.
;
    mov    ax, ldt_sel
    lldt   ax
;
; Using fs: and gs: prefixes on memory accesses still uses
; the 32-bit fs.base and gs.base. Reload these 2 registers
; before using the fs: and gs: prefixes. FS and GS can be
; loaded from the GDT using a normal "mov fs,foo" type
; instructions, which loads a 32-bit base into FS or GS.
; Alternatively, use WRMSR to assign 64-bit base values to
; MSR_FS_base or MSR_GS_base.
;
    mov    ecx, MSR_FS_base
    mov    eax, FsbaseLow
    mov    edx, FsbaseHi
    wrmsr
;
; Reload CR3 if long-mode page tables are to be located above
; 4 Gbytes. Because the original CR3 load was done in 32-bit
; legacy mode, it could only load 32 bits into CR3. Thus, the
; current page tables are located in the lower 4 Gbytes of
; physical memory. This MOV to CR3 is only needed if the
; actual long-mode page tables should be located at a linear
; address above 4 Gbytes.
;
    mov    rax, final_pml4_base ; Point to PML4
    mov    cr3, rax            ; Load 64-bit CR3
;
; Enable interrupts.
;
    sti                                ; Enabled INTR
    <insert 64-bit code here>

```



## 15 Secure Virtual Machine

---

AMD Virtualization™ (AMD-V™) architecture is designed to provide enterprise-class server virtualization software technology that facilitates virtualization development and deployment. An SVM enabled virtual machine architecture provides hardware resources that allow a single machine to run multiple operating systems efficiently, while maintaining secure, resource-guaranteed isolation.

### 15.1 The Virtual Machine Monitor

A *virtual machine monitor* (VMM), also known as a *hypervisor*, consists of software that controls the execution of multiple *guest* operating systems on a single physical machine. The VMM provides each guest the appearance of full control over a complete computer system (memory, CPU, and all peripheral devices). The use of the term *host* refers to the execution context of the VMM. *World switch* refers to the operation of switching between the host and guest.

Fundamentally, VMMs work by *intercepting* and emulating in a safe manner sensitive operations in the guest (such as changing the page tables, which could give a guest access to memory it is not allowed to access). The AMD SVM provides hardware assists to improve performance and facilitate implementation of virtualization.

### 15.2 SVM Hardware Overview

SVM processor support provides a set of hardware extensions designed to enable economical and efficient implementation of virtual machine systems. Generally speaking, hardware support falls into two complementary categories: *virtualization* support and *security* support.

#### 15.2.1 Virtualization Support

The AMD virtual machine architecture is designed to provide:

- A guest/host tagged TLB to reduce virtualization overhead
- External (DMA) access protection for memory
- Assists for interrupt handling, virtual interrupt support, and enhanced pause filter
- The ability to intercept selected instructions or events in the guest
- Mechanisms for fast world switch between VMM and guest

#### 15.2.2 Guest Mode

This new processor mode is entered through the VMRUN instruction. When in guest mode, the behavior of some x86 instructions changes to facilitate virtualization.

The CPUID function numbers 4000\_0000h–4000\_00FFh have been reserved for software use. Hypervisors can use these function numbers to provide an interface to pass information from the

hypervisor to the guest. This is similar to extracting information about a physical CPU by using CPUID. Hypervisors use the CPUID Fn 400000[FF:00] bit to denote a virtual platform.

Feature bit CPUID Fn0000\_0001\_ECX[31] has been reserved for use by hypervisors to indicate the presence of a hypervisor. Hypervisors set this bit to 1 and physical CPU's set this bit to zero. This bit can be probed by the guest software to detect whether they are running inside a virtual machine.

### 15.2.3 External Access Protection

Guests may be granted direct access to selected I/O devices. Hardware support is designed to prevent devices owned by one guest from accessing memory owned by another guest (or the VMM).

### 15.2.4 Interrupt Support

To facilitate efficient virtualization of interrupts, the following support is provided under control of VMCB flags:

**Intercepting physical interrupt delivery.** The VMM can request that physical interrupts cause a running guest to exit, allowing the VMM to process the interrupt.

**Virtual interrupts.** The VMM can inject virtual interrupts into the guest. Under control of the VMM, a virtual copy of the EFLAGS.IF interrupt mask bit, and a virtual copy of the APIC's task priority register are used transparently by the guest instead of the physical resources.

**Sharing a physical APIC.** SVM allows multiple guests to share a physical APIC while guarding against malicious or defective guests that might leave high-priority interrupts unacknowledged forever (and thus shut out other guest's interrupts).

### 15.2.5 Restartable Instructions

SVM is designed to safely restart, with the exception of task switches, any intercepted instruction (either atomic or idempotent) after the intercept.

### 15.2.6 Security Support

To further enable secure initialization SVM provides additional System support.

**Attestation.** The SKINIT instruction and associated system support (the Trusted Platform Module, or TPM) allow for verifiable startup of trusted software (such as a VMM), based on secure hash comparison.

## 15.3 SVM Processor and Platform Extensions

SVM hardware extensions can be grouped into the following categories:

- State switch—VMRUN, VMSAVE, VMLOAD instructions, global interrupt flag (GIF), and instructions to manipulate the latter (STGI, CLGI). (“VMRUN Instruction” on page 447,

“VMSAVE and VMLOAD Instructions” on page 470, “Global Interrupt Flag, STGI and CLGI Instructions” on page 474.)

- Intercepts—allow the VMM to intercept sensitive operations in the guest. (“Intercept Operation” on page 453 through “Miscellaneous Intercepts” on page 469)
- Interrupt and APIC assists—physical interrupt intercepts, virtual interrupt support, APIC.TPR virtualization. (“Global Interrupt Flag, STGI and CLGI Instructions” on page 474 and “Interrupt and Local APIC Support” on page 477)
- SMM intercepts and assists (“SMM Support” on page 481)
- External (DMA) access protection (“External Access Protection” on page 484)
- Nested paging support for two levels of address translation. (“Nested Paging” on page 491)
- Security—SKINIT instruction. (“Secure Startup with SKINIT” on page 498)

## 15.4 Enabling SVM

The VMRUN, VMLOAD, VMSAVE, CLGI, VMSCALL, and INVLPGA instructions can be used when the EFER.SVME is set to 1; otherwise, these instructions generate a #UD exception. The SKINIT and STGI instructions can be used when either the EFER.SVME bit is set to 1 or the feature flag CPUID Fn8000\_0001\_ECX[SKINIT] is set to 1; otherwise, these instructions generate a #UD exception.

Before enabling SVM, software should detect whether SVM can be enabled using the following algorithm:

```
if (CPUID Fn8000_0001_ECX[SVM] == 0)
    return SVM_NOT_AVAIL;

if (VM_CR.SVMDIS == 0)
    return SVM_ALLOWED;

if (CPUID Fn8000_000A_EDX[SVML]==0)
    return SVM_DISABLED_AT_BIOS_NOT_UNLOCKABLE
    // the user must change a platform firmware setting to enable SVM
else return SVM_DISABLED_WITH_KEY;
    // SVMLock may be unlockable; consult platform firmware or TPM to obtain the
    key.
```

For more information on using the CPUID instruction to obtain processor capability information, see Section 3.3, “Processor Feature Identification,” on page 63.

## 15.5 VMRUN Instruction

The VMRUN instruction is the cornerstone of SVM. VMRUN takes, as a single argument, the physical address of a 4KB-aligned page, the *virtual machine control block* (VMCB), which describes a virtual machine (guest) to be executed. The VMCB contains:

- a list of instructions or events in the guest (e.g., write to CR3) to intercept,
- various control bits that specify the execution environment of the guest or that indicate special actions to be taken before running guest code, and
- guest processor state (such as control registers, etc.).

Note that VMRUN is not supported inside the SMM handler and the behavior is undefined.

### 15.5.1 Basic Operation

The VMRUN instruction has an implicit addressing mode of [rAX]. Software must load RAX (EAX in 32-bit mode) with the physical address of the VMCB, a 4-Kbyte-aligned page that describes a virtual machine to be executed. The portion of RAX used in forming the address is determined by the current effective address size.

The VMCB is accessed by physical address and should be mapped as writeback (WB) memory.

VMRUN is available only at CPL-0. A #GP exception is raised if the CPL is greater than 0. Furthermore, the processor must be in protected mode and EFER.SVME must be set to 1, otherwise, a #UD exception is raised.

The VMRUN instruction saves some host processor state information in the host state-save area in main memory at the physical address specified in the VM\_HSAVE\_PA MSR; it then loads corresponding guest state from the VMCB state-save area. VMRUN also reads additional control bits from the VMCB that allow the VMM to flush the guest TLB, inject virtual interrupts into the guest, etc.

The VMRUN instruction then checks the guest state just loaded. If an illegal state has been loaded, the processor exits back to the host (see “#VMEXIT” on page 452).

Otherwise, the processor now runs the guest code until an intercept event occurs, at which point the processor suspends guest execution and resumes host execution at the instruction following the VMRUN. This is called a #VMEXIT and is described in detail in “#VMEXIT” on page 452.

VMRUN saves or restores a minimal amount of state information to allow the VMM to resume execution after a guest has exited. This allows the VMM to handle simple intercept conditions quickly. If additional guest state information must be saved or restored (e.g., to handle more complex intercepts or to switch to a different guest), the VMM can employ the VMSAVE and VMLOAD instructions (see “VMSAVE and VMLOAD Instructions” on page 470).

**Saving Host State.** To ensure that the host can resume operation after #VMEXIT, VMRUN saves at least the following host state information:

- CS.SEL, NEXT\_RIP—The CS selector and rIP of the instruction following the VMRUN. On #VMEXIT the host resumes running at this address.
- RFLAGS, RAX—Host processor mode and the register used by VMRUN to address the VMCB.
- SS.SEL, RSP—Stack pointer for host.



- CR0, CR3, CR4, EFER—Paging/operating mode for host.
- IDTR, GDTR—The pseudo-descriptors. VMRUN does not save or restore the host LDTR.
- ES.SEL and DS.SEL.

Processor implementations may store only part or none of host state in the memory area pointed to by VM\_HSAVE\_PA MSR and may store some or all host state in hidden on-chip memory. Different implementations may choose to save the hidden parts of the host's segment registers as well as the selectors. For these reasons, software must not rely on the format or contents of the host state save area, nor attempt to change host state by modifying the contents of the host save area.

**Loading Guest State.** After saving host state, VMRUN loads the following guest state from the VMCB:

- CS, rIP—Guest begins execution at this address. The hidden state of the CS segment register is also loaded from the VMCB.
- RFLAGS, RAX.
- SS, RSP—Includes the hidden state of the SS segment register.
- CR0, CR2, CR3, CR4, EFER—Guest paging mode. Writing paging-related control registers with VMRUN does *not* flush the TLB since address spaces are switched. See Section 15.16, “TLB Control,” on page 473.
- INTERRUPT\_SHADOW—This flag indicates whether the guest is currently in an interrupt lockout shadow; see “Interrupt Shadows” on page 479.
- IDTR, GDTR.
- ES and DS—Includes the hidden state of the segment registers.
- DR6 and DR7—The guest's breakpoint state.
- V\_TPR—The guest's virtual TPR.
- V\_IRQ—The flag indicating whether a virtual interrupt is pending in the guest.
- CPL—If the guest is in real mode, the CPL is forced to 0; if the guest is in v86 mode, the CPL is forced to 3. Otherwise, the CPL saved in the VMCB is used.

The processor checks the loaded guest state for consistency. If a consistency check fails while loading guest state, the processor performs a #VMEXIT. For additional information, see “Canonicalization and Consistency Checks” on page 451.

If the guest is in PAE paging mode according to the registers just loaded and nested paging is not enabled, the processor will also read the four PDPEs pointed to by the newly loaded CR3 value; setting any reserved bits in the PDPEs also causes a #VMEXIT.

It is possible for the VMRUN instruction to load a guest rIP that is outside the limit of the guest code segment or that is non-canonical (if running in long mode). If this occurs, a #GP fault is delivered inside the guest; the rIP falling outside the limit of the guest code segment is not considered illegal guest state.

After all guest state is loaded, and intercepts and other control bits are set up, the processor reenables interrupts by setting GIF to 1. It is assumed that VMM software cleared GIF some time before executing the VMRUN instruction, to ensure an atomic state switch.

Some processor models allow the VMM to designate certain guest VMCB fields as “clean,” meaning that they haven’t been modified relative to the current state of hardware. This allows the hardware to optimize execution of VMRUN. See Section 15.15, “VMCB State Caching,” on page 470, for details on which fields may be affected by this. The descriptions below assume all fields are loaded.

**Control Bits.** Besides loading guest state, the VMRUN instruction reads various control fields from the VMCB; most of these fields are not written back to the VMCB on #VMEXIT, since they cannot change during guest execution:

- TSC\_OFFSET—an offset to add when the guest reads the TSC (time stamp counter). Guest writes to the TSC can be intercepted and emulated by changing the offset (without writing the physical TSC). This offset is cleared when the guest exits back to the host.
- V\_INTR\_PRIO, V\_INTR\_VECTOR, V\_IGN\_TPR—fields used to describe a virtual interrupt for the guest (see “Injecting Virtual (INTR) Interrupts” on page 478).
- V\_INTR\_MASKING—controls whether masking of interrupts (in EFLAGS.IF and TPR) is to be virtualized (see Section 15.21 on page 477).
- The address space ID (ASID) to use while running the guest.
- A field to control flushing of the TLB during a VMRUN (see Section 15.16).
- The intercept vector describing the active intercepts for the guest. On exit from the guest, the internal intercept registers are cleared so no host operations will be intercepted.

The maximum ASID value supported by a processor is implementation specific. The value returned in EBX after executing CPUID Fn8000\_000A is the number of ASIDs supported by the processor.

See Section 3.3, “Processor Feature Identification,” on page 63 for more information on using the CPUID instruction.

**Segment State in the VMCB.** The segment registers are stored in the VMCB in a format similar to that for SMM: both base and limit are fully expanded; segment attributes are stored as 12-bit values formed by the concatenation of bits 55:52 and 47:40 from the original 64-bit (in-memory) segment descriptors; the descriptor “P” bit is used to signal NULL segments (P=0) where permissible and/or relevant. The loading of segment attributes from the VMCB (which may have been overwritten by software) may result in attribute bit values that are otherwise not allowed. However, only some of the attribute bits are actually observed by hardware, depending on the segment register in question:

- CS—D, L, and R.
- SS—B, P, E, W, and Code/Data
- DS, ES, FS, GS —D, P, DPL, E, W, and Code/Data.
- LDTR—Only the P bit is observed.
- TR—Only TSS type (32 or 16 bit) is relevant because a null TSS is not allowed.

NOTE: For the Stack Segment attributes, P is observed in legacy and compatibility mode. In 64-bit mode, P is ignored because all stack segments are treated as present.

The VMM should follow these rules when storing segment attributes into the VMCB:

- For NULL segments, set all attribute bits to zero; otherwise, write the concatenation of bits 55:52 and 47:40 from the original 64-bit (in-memory) segment descriptors.
- The processor reads the current privilege level from the CPL field in the VMCB. The CS.DPL will match the CPL field.
- When in virtual x86 or real mode, the processor ignores the CPL field in the VMCB and forces the values of 3 and 0, respectively.

When examining segment attributes after a #VMEXIT:

- Test the Present (P) bit to check whether a segment is NULL; note that CS and TR never contain NULL segments and so their P bit is ignored;
- Retrieve the CPL from the CPL field in the VMCB, not from any segment DPL.

**Canonicalization and Consistency Checks.** The VMRUN instruction performs consistency checks on guest state and #VMEXIT performs the appropriate subset of these consistency checks on host state. Illegal guest state combinations cause a #VMEXIT with error code VMEXIT\_INVALID. The following conditions are considered illegal state combinations:

- EFER.SVME is zero.
- CR0.CD is zero and CR0.NW is set.
- CR0[63:32] are not zero.
- Any MBZ bit of CR3 is set.
- Any MBZ bit of CR4 is set.
- DR6[63:32] are not zero.
- DR7[63:32] are not zero.
- Any MBZ bit of EFER is set.
- EFER.LMA or EFER.LME is non-zero and this processor does not support long mode.
- EFER.LME and CR0.PG are both set and CR4.PAE is zero.
- EFER.LME and CR0.PG are both non-zero and CR0.PE is zero.
- EFER.LME, CR0.PG, CR4.PAE, CS.L, and CS.D are all non-zero.
- The VMRUN intercept bit is clear.
- The MSR or IOIO intercept tables extend to a physical address that is greater than or equal to the maximum supported physical address.
- Illegal event injection (see Section 15.20 on page 476).
- ASID is equal to zero.

VMRUN can load a guest value of CR0 with PE = 0 but PG = 1, a combination that is otherwise illegal (see Section 15.19).

In addition to consistency checks, VMRUN and #VMEXIT canonicalize (i.e., sign-extend to 63 bits) all base addresses in the segment registers that have been loaded.

On processor models that support designation of clean fields, the final merged hardware state is used for consistency checks; this may include state from fields marked as clean, if the processor choose to ignore the indication.

**VMRUN and TF/RF Bits in EFLAGS.** When considering interactions of VMRUN with the TF and RF bits in EFLAGS, one must distinguish between the behavior of host as opposed to that of the guest.

From the host point of view, VMRUN acts like a single instruction, even though an arbitrary number of guest instructions may execute before a #VMEXIT effectively completes the VMRUN. As a single host instruction, VMRUN interacts with EFLAGS.RF and EFLAGS.TF like ordinary instructions. EFLAGS.RF suppresses any potential instruction breakpoint match on the VMRUN, and EFLAGS.TF causes a #DB trap after the VMRUN completes on the host side (i.e., after the #VMEXIT from the guest). As with any normal instruction, completion of the VMRUN instruction clears the host EFLAGS.RF bit.

The value of EFLAGS.RF from the VMCB affects the first guest instruction. When VMRUN loads a guest value of 1 for EFLAGS.RF, that value takes effect and suppresses any potential (guest) instruction breakpoint on the first guest instruction. When VMRUN loads a guest value of 1 in EFLAGS.TF, that value does *not* cause a trace trap between the VMRUN and the first guest instruction, but rather *after* completion of the first guest instruction.

Host values of EFLAGS have no effect on the guest and guest values of EFLAGS have no effect on the host.

See also Section 15.7.1 on page 454 regarding the value of EFLAGS.RF saved on #VMEXIT.

## 15.6 #VMEXIT

When an intercept triggers, the processor performs a #VMEXIT (i.e., an exit from the guest to the host context).

On #VMEXIT, the processor:

- Disables interrupts by clearing the GIF, so that after the #VMEXIT, VMM software can complete the state switch atomically.
- Writes back to the VMCB the current guest state—the same subset of processor state as is loaded by the VMRUN instruction, including the V\_IRQ, V\_TPR, and the INTERRUPT\_SHADOW bits.
- Saves the reason for exiting the guest in the VMCB's EXITCODE field; additional information may be saved in the EXITINFO1 or EXITINFO2 fields, depending on the intercept.
- Clears all intercepts.

- Resets the current ASID register to zero (host ASID).
- Clears the V\_IRQ and V\_INTR\_MASKING bits inside the processor.
- Clears the TSC\_OFFSET inside the processor.
- Reloads the host state previously saved by the VMRUN instruction. The processor reloads the host's CS, SS, DS, and ES segment registers and, if required, re-reads the descriptors from the host's segment descriptor tables, depending on the implementation. The segment descriptor tables must be mapped as present and writable by the host's page tables. Software should keep the host's segment descriptor tables consistent with the segment registers when executing VMRUN instructions. Immediately after #VMEXIT, the processor still contains the guest value for LDTR. So for CS, SS, DS, and ES, the VMM must only use segment descriptors from the global descriptor table. Any exception encountered while reloading the host segments causes a shutdown.
- If the host is in PAE mode, the processor reloads the host's PDPEs from the page table indicated by the host's CR3. If the PDPEs contain illegal state, the processor causes a shutdown.
- Forces CR0.PE = 1, RFLAGS.VM = 0.
- Sets the host CPL to zero.
- Disables all breakpoints in the host DR7 register.
- Checks the reloaded host state for consistency; any error causes the processor to shutdown. If the host's rIP reloaded by #VMEXIT is outside the limit of the host's code segment or non-canonical (in the case of long mode), a #GP fault is delivered inside the host.

## 15.7 Intercept Operation

Various instructions and events (such as exceptions) in the guest can be intercepted by means of control bits in the VMCB. The two primary classes of intercepts supported by SVM are instruction and exception intercepts.

**Exception intercepts.** Exception intercepts are checked when normal instruction processing must raise an exception before resolving possible double-fault conditions and before attempting delivery of the exception (which includes pushing an exception frame, accessing the IDT, etc.).

For some exceptions, the processor still writes certain exception-specific registers even if the exception is intercepted. (See the descriptions in Section 15.12 on page 464 and following for details.) When an external or virtual interrupt is intercepted, the interrupt is left pending.

When an intercept occurs while the guest is in the process of delivering a non-intercepted interrupt or exception using the IDT, SVM provides additional information on #VMEXIT (See Section 15.7.2 on page 454).

**Instruction intercepts.** These occur at well-defined points in instruction execution—before the results of the instruction are committed, but ordered in an intercept-specific priority relative to the instruction's exception checks. Generally, instruction intercepts are checked after simple exceptions (such as #GP—when CPL is incorrect—or #UD) have been checked, but before exceptions related to memory accesses (such as page faults) and exceptions based on specific operand values. There are

several exceptions to this guideline, e.g., the RSM instruction. Instruction breakpoints for the current instruction and pending data breakpoint traps from the previous instruction are designed to be checked before instruction intercepts.

### 15.7.1 State Saved on Exit

When triggered, intercepts write an EXITCODE into the VMCB identifying the cause of the intercept. The EXITINTINFO field signals whether the intercept occurred while the guest was attempting to deliver an interrupt or exception through the IDT; a VMM can use this information to transparently complete the delivery (see “Event Injection” on page 476). Some intercepts provide additional information in the EXITINFO1 and EXITINFO2 fields in the VMCB; see the individual intercept descriptions for details.

The guest state saved in the VMCB is the processor state as of the moment the intercept triggers. In the x86 architecture, traps (as opposed to faults) are detected and delivered after the instruction that triggered them has completed execution. Accordingly, a trap intercept takes place after the execution of the instruction that triggered the trap in the first place. The saved guest state thus includes the effects of executing that instruction.

**Example:** Assume a guest instruction triggers a data breakpoint (#DB) trap which is in turn intercepted. The VMCB records the guest state after execution of that instruction, so that the saved CS:rIP points to the following instruction, and the saved DR7 includes the effects of matching the data breakpoint.

The next sequential instruction pointer (nRIP) is saved in the guest VMCB control area at location C8h on all #VMEXITs that are due to instruction intercepts, as defined in Section 15.9 on page 459, as well as MSR and IOIO intercepts and exceptions caused by the INT3, INTO, and BOUND instructions. For all other intercepts, nRIP is reset to zero.

The nRIP is the RIP that would be pushed on the stack if the current instruction were subject to a trap-style debug exception, if the intercepted instruction were to cause no change in control flow. If the intercepted instruction would have caused a change in control flow, the nRIP points to the next sequential instruction rather than the target instruction.

Some exceptions write special registers even when they are intercepted; see the individual descriptions in “Exception Intercepts” on page 464 for details.

Support for the NRIP save on #VMEXIT is indicated by CPUID Fn8000\_000A\_EDX[NRIPS]. See Section 3.3, “Processor Feature Identification,” on page 63 for more information on using the CPUID instruction.

### 15.7.2 Intercepts During IDT Interrupt Delivery

It is possible for an intercept to occur while the guest is attempting to deliver an exception or interrupt through the IDT (e.g., #PF because the VMM has paged out the guest’s exception stack). In some cases, such an intercept can result in the loss of information necessary for transparent resumption of the guest. In the case of an external interrupt, for example, the processor will already have performed



- **Errorcode**—Bits 63:32. If EV is set to 1, holds the error code that the guest exception would have pushed; otherwise is undefined.

In the case of multiple exceptions, EXITINTINFO records the aggregate information on all exceptions but the last (intercepted) one.

**Example:** A guest raises a #GP during delivery of which a #NP is raised (a scenario that, according to x86 rules, resolves to a #DF), and an intercepted #PF occurs during the attempt to deliver the #DF. Upon intercept of the #PF, EXITINTINFO indicates that the guest was in the process of delivering a #DF when the #PF occurred. The information about the intercepted page fault itself is encoded in the EXITCODE, EXITINFO1 and EXITINFO2 fields. If the VMM decides to repair and dismiss the #PF, it can resume guest execution by re-injecting (see “Event Injection” on page 476) the fault recorded in EXITINTINFO. If the VMM decides that the #PF should be reflected back to the guest, it must combine the event in EXITINTINFO with the intercepted exception according to x86 rules. In this case, a #DF plus a #PF would result in a triple fault or shutdown.

### 15.7.3 EXITINTINFO Pseudo-Code

When delivering exceptions or interrupts in a guest, the processor checks for exception intercepts and updates the value of EXITINTINFO should an intercept occur during exception delivery. The following pseudo-code outlines how the processor delivers an event (exception or interrupt) E.

```
if E is an exception and is intercepted:
    #VMEXIT(E)
E = (result of combining E with any prior events)

if (result was #DF and #DF is intercepted):
    #VMEXIT(#DF)
if (result was shutdown and shutdown is intercepted):
    #VMEXIT(#shutdown)
EXITINTINFO = E // Record the event the guest is delivering.
```

Attempt delivery of E through the IDT  
Note that this may cause secondary exceptions

Once an exception has been successfully taken in the guest:

```
EXITINTINFO.V = 0 // Delivery succeeded; no #VMEXIT.
Dispatch to first instruction of handler
```

When an exception triggers an intercept, the EXITCODE, and optionally EXITINFO1 and EXITINFO2, fields always reflect the intercepted exception, while EXITINTINFO, if marked valid, indicates the prior exception the guest was attempting to deliver when the intercept occurred.



## 15.8 Decode Assists

Decode assists are provided to allow hypervisors to decode guest instructions more efficiently. CPUID Fn8000\_000A\_EDX[DecodeAssists] = 1 indicates support for this feature. See Section 3.3, “Processor Feature Identification,” on page 63 for more information on using the CPUID instruction.

### 15.8.1 MOV CR<sub>x</sub>/DR<sub>x</sub> Intercepts

The EXITINFO1 field holds a flag indicating whether the instruction was a MOV CR<sub>x</sub> and the number of the GPR operand. MOV-to-CR instructions always set bit 63 and provide the GPR number, except for CR0 as specified below.

**Table 15-2. EXITINFO1 for MOV CR<sub>x</sub>**

Bit Offsets	Field Contents
3:0	GPR number
62:4	0
63	Instruction was MOV CR <sub>x</sub> —set to 1 if the instruction was a MOV CR <sub>x</sub> instruction; cleared to 0 otherwise.

**Table 15-3. EXITINFO1 for MOV DR<sub>x</sub>**

Bit Offsets	Field Contents
3:0	GPR number
63:4	0

**MOV-to-CR0 Special Case.** If the instruction is MOV-to-CR, the GPR number is provided; if the instruction is LMSW or CLTS, no additional information is provided and bit 63 is not set.

**MOV-from-CR0 Special Case.** If the instruction is MOV-from-CR, the GPR number is provided and bit 63 is set; if the instruction is SMSW, no information is provided and bit 63 is not set.

### 15.8.2 INT<sub>n</sub> Intercepts

EXITINFO1 records the immediate value of the interrupt number for INT *n* instructions. See Table 15-4.

**Table 15-4. EXITINFO1 for INT<sub>n</sub>**

Bit Offsets	Field Contents
7:0	Software interrupt number

**Table 15-4. EXITINFO1 for INT $n$** 

Bit Offsets	Field Contents
63:8	0

### 15.8.3 INVLPG and INVLPGA Intercepts

For an INVLPG intercept, EXITINFO1 provides the linear address after segment base addition and address size masking produce the effective address size. See Table 15-5. For an INVLPGA intercept, the linear address is available directly from the guest rAX register and is not provided in EXITINFO1.

**Table 15-5. EXITINFO1 for INVLPG**

Bit Offsets	Field Contents
63:0	Linear address

### 15.8.4 Nested and intercepted #PF

In the case of a Nested Page Fault or intercepted #PF, guest instruction bytes at guest CS:RIP are stored into the 16-byte wide field Guest Instruction Bytes located at offset 0D0h in the VMCB. The format of this field is summarized in Table 15-6 below. Up to 15 bytes are recorded, read from guest CS:RIP. If a faulting condition occurs, such as not-present page or exceeding the CS limit, then the Guest Instruction Bytes field records as many bytes as could be fetched. The number of bytes fetched is put into the first byte of this field. Zero indicates that no bytes were fetched. The default number of bytes is always 15. Fewer bytes are returned only if a fault occurs while fetching.

This field is filled in only during data page faults. Instruction-fetch page faults provide no additional information.

All other intercepts clear bits 0:7 in this field to zero (to indicate an invalid condition); implementations may leave the other bytes untouched.

**Table 15-6. Guest Instruction Bytes**

Bit Offsets	Field Contents
3:0	Number of bytes fetched
4:7	0
127:8	Instruction bytes

## 15.9 Instruction Intercepts

Table 15-7 specifies the instructions that check a given intercept and, where relevant, how the intercept is prioritized relative to exceptions.

**Table 15-7. Instruction Intercepts**

Instruction Intercept	Checked By	Priority
Read/Write of CR0	MOV TO/FROM CR0, LMSW, SMSW, CLTS	Checks non-memory exceptions (CPL, illegal bit combinations, etc.) before the intercept. For LMSW and SMSW, checks SVM intercepts before checking memory exceptions.
Read/Write of CR3 (excluding task switch)	MOV TO/FROM CR3 (not checked by task switch operations)	Checks non-memory exceptions first, then the intercept. If the intercept triggers on a write, the intercept happens <i>before</i> the TLB is flushed. If PAE is enabled, the loading of the four PDPEs can cause a #GP; that exception is checked <i>after</i> the intercept check, so the VMM handling a CR3 intercept cannot rely on the PDPEs being legal; it must examine them in software if necessary. The reads and writes of CR3 that occur in VMRUN, #VMEXIT or task switches are <i>not</i> subject to this intercept check.
Read/Write of other CRs	MOV TO/FROM CR <sub>n</sub>	All normal exception checks take precedence over the SVM intercepts.
Read/Write of Debug Registers, DR <sub>n</sub>	MOV TO/FROM DR <sub>n</sub> . (Not checked by implicit DR6/DR7 writes.)	All normal exception checks take precedence over the SVM intercepts.
Selective CR0 Write Intercept	MOV TO CR0, LMSW	Checks non-memory exceptions (CPL, illegal bit combinations, etc.) before the intercept. For LMSW and SMSW, checks SVM intercepts before checking memory exceptions. The selective write intercept on CR0 triggers only if a bit other than CR0.TS or CR0.MP is being changed by the write. In particular, this means that CLTS does not check this intercept. When both selective and non-selective CR0-write intercepts are active at the same time, the non-selective intercept takes priority. With respect to exceptions, the priority of this intercept is the same as the generic CR0-write intercept. The LMSW instruction treats the selective CR0-write intercept as a non-selective intercept (i.e., it intercepts regardless of the value being written).
Reading or Writing IDTR, GDTR, LDTR, TR	LIDT, SIDT, LGDT, SGDT, LLDT, SLDT, LTR, STR	The SVM intercept is checked after #UD and #GP exception checks, but before any memory access is performed.

Table 15-7. Instruction Intercepts (continued)

Instruction Intercept	Checked By	Priority
RDTSC	RDTSC	Checks all exceptions before the SVM intercept.
RDPMC	RDPMC	Checks all exceptions before the SVM intercept.
PUSHF	PUSHF	Takes priority over any exceptions.
POPF	POPF	Takes priority over any exceptions.
CPUID	CPUID	No exceptions to check.
RSM	RSM	The intercept takes priority over any exceptions.
IRET	IRET	The intercept takes priority over any exceptions.
Software Interrupt	INT $n$	The intercept occurs before any exceptions are checked. The CS:rIP reported on #VMEXIT are those of the intercepted INT $n$ instruction. Though the INT $n$ instruction may dispatch through IDT vectors in the range of 0–31, those events cannot be intercepted by means of exception intercepts (see “Exception Intercepts” on page 464).
INVD	INVD	Exceptions (#GP) are checked before the intercept.
PAUSE	PAUSE	No exceptions to check. VMRUN copies the VMCB.PauseFilterCount into an internal counter. Each PAUSE instruction decrements the counter, and the PAUSE intercept only occurs if the counter goes below zero while the PAUSE intercept is enabled. The VMCB.PauseFilterCount field is not written by the processor. Certain events, including SMI, can cause the internal count to be reloaded from the VMCB. VMCB.PauseFilterCount support is indicated by EDX[10] as returned by CPUID extended function 8000_000A. If This feature is not supported or VMCB.PauseFilterCount = 0, then the first PAUSE instruction can be intercepted.
HLT	HLT	Checks all exceptions before checking for this intercept.
INVLPG	INVLPG	Checks all exceptions (#GP) before the intercept.
INVLPGA	INVLPGA	Checks all exceptions (#GP) before the intercept.
VMRUN	VMRUN	Checks exceptions (#GP) before the intercept. <i>The current implementation requires that the VMRUN intercept always be set in the VMCB.</i>
VMLOAD	VMLOAD	Checks exceptions (#GP) before the intercept.
VMSAVE	VMSAVE	Checks exceptions (#GP) before the intercept.

**Table 15-7. Instruction Intercepts (continued)**

Instruction Intercept	Checked By	Priority
VMMCALL	VMMCALL	The intercept takes priority over exceptions. VMMCALL causes #UD in the guest if it is not intercepted.
STGI	STGI	Checks exceptions (#GP) before the intercept.
CLGI	CLGI	Checks exceptions (#GP) before the intercept.
SKINIT	SKINIT	Checks exceptions (#GP) before the intercept.
RDTSCP	RDTSCP	Checks all exceptions before the SVM intercept.
ICEBP	ICEBP(opcode F1h).	Although the ICEBP instruction dispatches through IDT vector 1, that event is not interceptable by means of the #DB exception intercept.
WBINVD	WBINVD	Checks exceptions (#GP) before the intercept.
MONITOR	MONITOR, MONITORX	Checks all exceptions before the intercept.
MWAIT	MWAIT, MWAITX	Checks all exceptions before the intercept. There are conditional and unconditional MWAIT intercepts. The conditional MWAIT intercept is checked before the unconditional MWAIT intercept. When both conditional and unconditional MWAIT intercepts are active, the conditional intercept is checked first. A hypervisor that sets both intercepts will receive the conditional MWAIT intercept exit code for a guest MWAIT instruction that would have entered a low-power state, and will receive the unconditional MWAIT intercept exit code for a guest MWAIT instruction that would not have entered the low-power state. These checks also apply to MWAITX.
XSETBV	XSETBV	Checks intercept before exceptions (#GP)

## 15.10 IOIO Intercepts

The VMM can intercept IOIO instructions (IN, OUT, INS, OUTS) on a port-by-port basis by means of the SVM I/O permissions map.

### 15.10.1 I/O Permissions Map

The I/O Permissions Map (IOPM) occupies 12 Kbytes of contiguous physical memory. The map is structured as a linear array of 64K+3 bits (two 4-Kbyte pages, and the first three bits of a third 4-Kbyte page) and must be aligned on a 4-Kbyte boundary; the physical base address of the IOPM is specified in the IOPM\_BASE\_PA field in the VMCB and loaded into the processor by the VMRUN instruction. The VMRUN instruction ignores the lower 12 bits of the address specified in the VMCB. If the

address of the last byte in the IOPM is greater than or equal to the maximum supported physical address, this is treated as illegal VMCB state and causes a #VMEXIT(VMEXIT\_INVALID).

Each bit in the IOPM corresponds to an 8-bit I/O port. Bit 0 in the table corresponds to I/O port 0, bit 1 to I/O port 1 and so on. A bit set to 1 indicates that accesses to the corresponding port should be intercepted. The IOPM is accessed by physical address, and should reside in memory that is mapped as writeback (WB).

### 15.10.2 IN and OUT Behavior

If the IOIO\_PROT intercept bit is set, the IOPM controls port access. For IN/OUT instructions that access more than a single byte, the permission bits for all bytes are checked; if any bit is set to 1, the I/O operation is intercepted.

Exceptions related to virtual x86 mode, IOPL, or the TSS-bitmap are checked *before* the SVM intercept check. All other exceptions are checked *after* the SVM intercept check.

**I/O Intercept Information.** When an IOIO intercept triggers, the following information (describing the intercepted operation in order to facilitate emulation) is saved in the VMCB’s EXITINFO1 field:

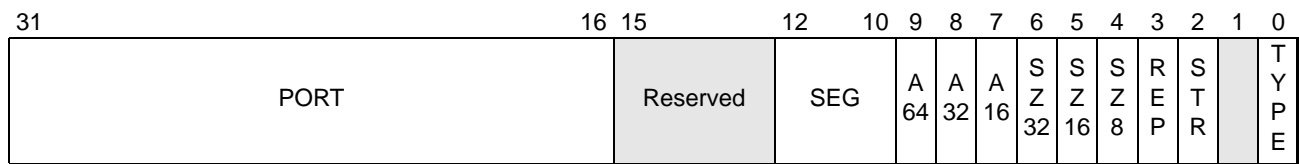

Bits	Mnemonic	Description
31:16	PORT	Intercepted I/O port
15:13	—	Reserved
12:10	SEG	Effective segment number
9	A64	64-bit address
8	A32	32-bit address
7	A16	16-bit address
6	SZ32	32-bit operand size
5	SZ16	16-bit operand size
4	SZ8	8-bit operand size
3	REP	Repeated port access
2	STR	String based port access (INS, OUTS)
1	—	Reserved
0	TYPE	Access Type (0 = OUT instruction, 1 = IN instruction)

**Figure 15-2. EXITINFO1 for IOIO Intercept**

The rIP of the instruction *following* the IN/OUT is saved in EXITINFO2, so that the VMM can easily resume the guest after I/O emulation.

### 15.10.3 (REP) OUTS and INS

Bits 12:10 of the EXITINFO1 field provide the effective segment number (the default segment is DS). (For segment register encodings, see Table A-32, “16-Bit Register and Memory References” on page 478, in *AMD64 Architecture Programmer’s Manual Volume 3: General-Purpose and System Instructions*.)

INS provides the effective segment (always ES, encoded as 0).

On intercepted SMI-on-I/O, bits 12:10 of EXITINFO1 encode the segment. For definitions of the remaining bits of this field, see section 15.13.3 on page 467.

## 15.11 MSR Intercepts

The VMM can intercept RDMSR and WRMSR instructions by means of the *SVM MSR permissions map* (MSRPM) on a per-MSR basis.

**MSR Permissions Map.** The MSR permissions bitmap consists of four separate bit vectors of 16 Kbits (2 Kbytes) each. Each 16 Kbit vector controls guest access to a defined range of 8K MSRs. Each MSR is covered by two bits defining the guest read and write access permissions. The lsb of the two bits controls read access to the MSR and the msb controls write access. A value of 1 indicates that the operation is intercepted. The four separate bit vectors must be packed together and located in two contiguous physical pages of memory. If the MSR\_PROT intercept is active, any attempt to read or write an MSR not covered by the MSRPM will automatically cause an intercept.

The following table defines the ranges of MSRs covered by the MSR permissions map. Note that the MSR ranges are not contiguous.

**Table 15-8. MSR Ranges Covered by MSRPM**

MSRPM Byte Offset	MSR Range
000h–7FFh	0000_0000h–0000_1FFFh
800h–FFFh	C000_0000h–C000_1FFFh
1000h–17FFh	C001_0000h–C001_1FFFh
1800h–1FFFh	Reserved

The MSRPM is accessed by physical address and should reside in memory that is mapped as writeback (WB). The MSRPM must be aligned on a 4KB boundary. The physical base address of the MSRPM is specified in MSRPM\_BASE\_PA field in the VMCB and is loaded into the processor by the VMRUN instruction. The VMRUN instruction ignores the lower 12 bits of the address specified in the VMCB, and if the address of the last byte in the table is greater than or equal to the maximum supported physical address, this is treated as illegal VMCB state and causes a #VMEXIT(VMEXIT\_INVALID).

**RDMSR and WRMSR Behavior.** If the MSR\_PROT bit in the VMCB's intercept vector is clear, RDMSR/WRMSR instructions are not intercepted.

RDMSR and WRMSR instructions check for exceptions and intercepts in the following order:

- Exceptions common to all MSRs (e.g., #GP if not at CPL-0)
- Check SVM intercepts in the MSR permission map, if the MSR\_PROT intercept is requested.
- Exceptions specific to a given MSR (including password protection, unimplemented MSRs, reserved bits, etc.)

**MSR Intercept Information.** On #VMEXIT, the processor indicates in the VMCB's EXITINFO1 whether a RDMSR (EXITINFO1 = 0) or WRMSR (EXITINFO1 = 1) was intercepted.

## 15.12 Exception Intercepts

When intercepting exceptions that define an error code (normally pushed onto the exception stack), the SVM hardware delivers that error code in the VMCB's EXITINFO1 field; the exception vector number can be derived from the EXITCODE. The CS.SEL and rIP saved in the VMCB on an exception-intercept match those that would otherwise have been pushed onto the exception stack frame, except that when an interrupt-based instruction causes an intercept, the rIP of the instruction is stored in the VMCB, rather than the rIP of the next instruction. The interrupt-based instructions are INT3 (opcode CC), INTO, and BOUND.

Unless otherwise noted below, no special registers are written before an exception is intercepted. For details on guest state saved in the VMCB, see Section 15.7.1.

External interrupts and software interrupts (INT $n$  instruction) do not check the exception intercepts, even when they use a vector in the range 0 to 31.

Exceptions that occur during the handling of a prior exception are checked for intercepts *before* being combined with the prior exception (e.g., into a double-fault). If the result of combining exceptions is a double-fault or shutdown, the processor checks whether those are intercepted before attempting delivery.

**Example:** Assume that the VMM intercepts #GP and #DF exceptions, and the guest raises a (non-intercepted) #NP, during the delivery of which it also gets a #GP (e.g., due to an illegal IDT entry)—a situation that, according to x86 semantics, results in a #DF. In this case, #VMEXIT signals an intercepted #GP, *not* an intercepted #DF and fills EXITINTINFO with the #NP fault. On the other hand, if only the #DF intercept were active in this scenario, #VMEXIT would signal an intercepted #DF.

The following subsections detail the individual intercepts.



### 15.12.1 #DE (Divide By Zero)

The EXITINFO1 and EXITINFO2 fields are undefined.

### 15.12.2 #DB (Debug)

The #DB exception can have fault-type (e.g., instruction breakpoint) or trap-type (e.g., data breakpoint) behavior; accordingly the intercept differs in what state is saved in the VMCB (see “State Saved on Exit” on page 454). In either case, however, the value saved for DR6 and DR7 matches what would be visible to a #DB exception handler (i.e., both #DB faults and traps are permitted to write DR6 and DR7 before the intercept). The EXITINFO1 and EXITINFO2 fields are undefined.

Fault-type #DB exceptions, whether indicated in EXITCODE or EXITINTINFO, cause the CS:rIP saved in the VMCB to indicate the instruction that caused the #DB exception. Trap-type #DB exceptions cause the VMCB’s CS:rIP to indicate the instruction following the instruction that caused the exception. A vector 1 exception generated by the single byte INT1 instruction (also known as ICEBP) does not trigger the #DB intercept. Software should use the dedicated ICEBP intercept to intercept ICEBP (see “Instruction Intercepts” on page 459).

### 15.12.3 Vector 2 (Reserved)

This intercept bit is not implemented; use the NMI intercept (Section 15.13.2) instead. The effect of setting this bit is undefined.

### 15.12.4 #BP (Breakpoint)

This intercept applies to the trap raised by the single byte INT3 (opcode CCh) instruction. The EXITINFO1 and EXITINFO2 fields are undefined. The CS:rIP reported on #VMEXIT are those of the INT3 instruction.

### 15.12.5 #OF (Overflow)

This intercept applies to the trap raised by the INTO (opcode CEh) instruction. The EXITINFO1 and EXITINFO2 fields are undefined.

### 15.12.6 #BR (Bound-Range)

This intercept applies to the fault raised by the BOUND instruction. The EXITINFO1 and EXITINFO2 fields are undefined.

### 15.12.7 #UD (Invalid Opcode)

The EXITINFO1 and EXITINFO2 fields are undefined.

### 15.12.8 #NM (Device-Not-Available)

The EXITINFO1 and EXITINFO2 fields are undefined.

### 15.12.9 #DF (Double Fault)

The EXITINFO1 and EXITINFO2 fields are undefined. The rIP value saved in the VMCB is undefined (as is the case for the rIP value pushed on the stack for #DF exceptions). If a double fault is intercepted, the exceptions leading up to the double fault will have written any status registers normally written by those exceptions.

### 15.12.10 Vector 9 (Reserved)

This intercept is not implemented. The effect of setting this bit is undefined.

### 15.12.11 #TS (Invalid TSS)

The EXITINFO1 and EXITINFO2 fields are undefined. The rIP value saved in the VMCB may point to either the instruction causing the task switch, or to the first instruction of the incoming task. See “Task Switch Intercept” on page 469 for information in the EXITINFO1 and EXITINFO2 fields.

### 15.12.12 #NP (Segment Not Present)

The EXITINFO1 field contains the error code that would be pushed on the stack by a #NP exception. The EXITINFO2 field is undefined.

### 15.12.13 #SS (Stack Fault)

The EXITINFO1 field contains the error code that would be pushed on the stack by a #SS exception. The EXITINFO2 field is undefined.

### 15.12.14 #GP (General Protection)

The EXITINFO1 field contains the error code that would be pushed on the stack by a #GP exception.

### 15.12.15 #PF (Page Fault)

This intercept is tested *before* CR2 is written by the exception. The error code saved in EXITINFO1 is the same as would be pushed onto the stack by a non-intercepted #PF exception in protected mode. The faulting address is saved in the EXITINFO2 field in the VMCB. Even when the guest is running in paged real mode, the processor will deliver the (protected-mode) page-fault error code in EXITINFO1, for the VMM to use in analyzing the intercepted #PF. The processor may provide additional instruction decode assist information. (See Section 15.8.4, “Nested and intercepted #PF,” on page 458.)

### 15.12.16 #MF (X87 Floating Point)

This intercept is tested *after* the floating point status word has been written, as is the case for a normal FP exception. The EXITINFO1 and EXITINFO2 fields are undefined.

### 15.12.17 #AC (Alignment Check)

The EXITINFO1 field contains the error code that would be pushed on the stack by an #AC exception. The EXITINFO2 field is undefined.

### 15.12.18 #MC (Machine Check)

The SVM intercept is checked after all #MC-specific registers have been written, but before other guest state is modified. When #MC is being intercepted, a machine-check exits to the VMM, whenever possible, and shuts down the processor only when this is not a reasonable option. The EXITINFO1 and EXITINFO2 fields are undefined.

### 15.12.19 #XF (SIMD Floating Point)

This intercept is tested after the SIMD status word (MXCSR) has been written, as is the case for a normal FP exception. The EXITINFO1 and EXITINFO2 fields are undefined.

## 15.13 Interrupt Intercepts

External interrupts, when intercepted, cause a #VMEXIT; the interrupt is held pending so that the interrupt can eventually be taken in the VMM. Exception intercepts do not apply to external or software interrupts, so it is not possible to intercept an interrupt by means of the exception intercepts, even if the interrupt should happen to use a vector in the range from 0 to 31.

### 15.13.1 INTR Intercept

This intercept affects physical, as opposed to virtual, maskable interrupts. See “Virtual Interrupt Intercept” on page 480 for virtualization of maskable interrupts.

### 15.13.2 NMI Intercept

This intercept affects non-maskable interrupts. NMI interrupts (and SMIs) may be blocked for one instruction following an STI.

### 15.13.3 SMI Intercept

This intercept affects System Management Mode Interrupts (SMIs); see “SMM Support” on page 481 for details on SMI handling.

When this intercept triggers, bit 0 of the EXITINFO1 field distinguishes whether the SMI was caused internally by I/O Trapping (bit 0 = 0), or asserted externally (bit 0 = 1).

If the SMI was asserted while the guest was executing an I/O instruction, extra information (describing the I/O instruction) is saved in the upper 32 bits of EXITINFO1, and the RIP of the I/O instruction is saved in EXITINFO2. EXITINFO1 indicates that SMI was asserted during an I/O instruction when the VALID bit is set.

If the SMI wasn't asserted during an I/O instruction, the extra EXITINFO1 and EXITINFO2 bits are undefined.

The SMI intercept is ignored when HWCR[SMMLOCK] is set.

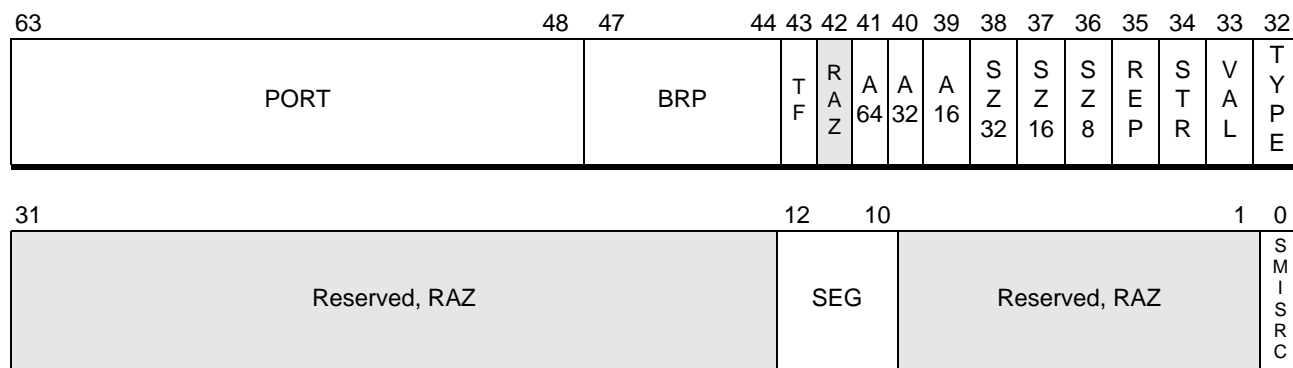

Bits	Mnemonic	Description
63:48	PORT	Intercepted I/O port
47:44	BRP	I/O breakpoint matches
43	TF	EFLAGS TF value
42	—	Reserved, RAZ
41	A64	64-bit address
40	A32	32-bit address
39	A16	16-bit address
38	SZ32	32-bit operand size
37	SZ16	16-bit operand size
36	SZ8	8-bit operand size
35	REP	Repeated port access
34	STR	String based port access (INS, OUTS)
33	VAL	Valid (SMI was detected during an I/O instruction)
32	TYPE	Access Type (0 = OUT instruction, 1 = IN instruction)
31:13	—	Reserved, RAZ
12:10	SEG	Effective segment number (see section 15.9)
9:1	—	Reserved, RAZ
0	SMISRC	SMI source (0 = internal, 1 = external)

**Figure 15-3. EXITINFO1 for SMI Intercept**

#### 15.13.4 INIT Intercept

The INIT intercept allows the VMM to intercept the assertion of INIT while a guest is running; see “INIT Support” on page 480 for a discussion of the INIT-redirection feature.

#### 15.13.5 Virtual Interrupt Intercept

This intercept is taken just before a guest takes a virtual interrupt. When the intercept triggers, the virtual interrupt has not been taken, and remains pending in the guest's VMCB V\_IRQ field. This intercept is not required for handling fixed local APIC interrupts, but may be used for emulating ExtINT interrupt delivery mode (which is not masked by the TPR), or legacy PICs in auto-EOI mode.

## 15.14 Miscellaneous Intercepts

The SVM architecture includes intercepts to handle task switches, processor freezes due to FERR, and shutdown operations.

### 15.14.1 Task Switch Intercept

**Checked by**—Any instruction or event that causes a task switch (e.g., JMP, CALL, exceptions, interrupts, software interrupts).

**Priority**—The intercept is checked before the task switch takes place but *after* the incoming TSS and task gate (if one was involved) have been checked for correctness.

Task switches can modify several resources that a VMM may want to protect (CR3, EFLAGS, LDT). However, instead of checking various intercepts (e.g., CR3 Write, LDTR Write) individually, task switches check only a single intercept bit.

On #VMEXIT, the following information is delivered in the VMCB:

- EXITINFO1[15:0] holds the segment selector identifying the incoming TSS.
- EXITINFO2[31:0] holds the error code to push in the new task, if applicable; otherwise, this field is undefined.
- EXITINFO2[63:32] holds auxiliary information for the VMM:
  - EXITINFO2[36]—Set to 1 if the task switch was caused by an IRET; else cleared to 0.
  - EXITINFO2[38]—Set to 1 if the task switch was caused by a far jump; else cleared to 0.
  - EXITINFO2[44]—Set to 1 if the task switch has an error code; else cleared to 0.
  - EXITINFO2[48]—The value of EFLAGS.RF that would be saved in the outgoing TSS if the task switch were not intercepted.

### 15.14.2 Ferr\_Freeze Intercept

Checked when the processor freezes due to assertion of FERR (while IGNNE is deasserted, and legacy handling of FERR is selected in CR0.NE), i.e., while the processor is waiting to be unfrozen by an external interrupt.

### 15.14.3 Shutdown Intercept

When this intercept occurs, any condition that normally causes a shutdown causes a #VMEXIT to the VMM instead. After an intercepted shutdown, the state saved in the VMCB is undefined.

### 15.14.4 Pause Intercept Filtering

On processors that support Pause filtering (indicated by CPUID Fn8000\_000A\_EDX[PauseFilter] = 1), the VMCB provides a 16 bit PAUSE Filter Count value. On VMRUN this value is loaded into an internal counter. Each time a PAUSE instruction is executed, this counter is decremented until it reaches zero at which time a #VMEXIT is generated if PAUSE intercept is enabled. If the PAUSE

Filter Count is set to zero and PAUSE Intercept is enabled, every PAUSE instruction will cause a #VMEXIT.

In addition, some processor families support Advanced Pause Filtering (indicated by CPUID Fn8000\_000A\_EDX[PauseFilterThreshold] = 1). In this mode, a 16-bit PAUSE Filter Threshold field is added in the VMCB. The threshold value is a cycle count that is used to reset the pause counter.

As with simple Pause filtering, VMRUN loads the PAUSE count VMCB value into an internal counter. Then, on each PAUSE instruction the hardware checks the elapsed number of cycles since the most recent PAUSE instruction against the PAUSE Filter Threshold. If the elapsed cycle count is greater than the PAUSE Filter Threshold, then the internal pause count is reloaded from the VMCB and execution continues. If the elapsed cycle count is less than the PAUSE Filter Threshold, then the internal pause count is decremented. If the count value is less than zero and PAUSE intercept is enabled, a #VMEXIT is triggered.

If Advanced Pause Filtering is supported and PAUSE Filter Threshold field is set to zero, the filter will operate in the simpler, count only mode.

See Section 3.3, “Processor Feature Identification,” on page 63 for more information on using the CPUID instruction.

**VMSAVE and VMLOAD Instructions.** The VMSAVE and VMLOAD instructions take the physical address of a VMCB in rAX. These instructions complement the state save/restore abilities of VMRUN instruction and #VMEXIT. They provide access to hidden processor state that software cannot otherwise access, as well as additional privileged state.

VMSAVE saves the following state to the VMCB indicated by rAX:

- FS, GS, TR, LDTR (including all hidden state)
- KernelGsBase
- STAR, LSTAR, CSTAR, SFMASK
- SYSENTER\_CS, SYSENTER\_ESP, SYSENTER\_EIP

VMLOAD loads the corresponding state from the VMCB. VMLOAD and VMSAVE are available only at CPL-0 (#GP otherwise), and in protected mode with SVM enabled in EFER.SVME (#UD otherwise).

## 15.15 VMCB State Caching

VMCB state caching allows the processor to cache certain guest register values in hardware between a #VMEXIT and subsequent VMRUN instructions and use the cached values to improve context-switch performance. Depending on the particular processor implementation, VMRUN loads each guest register value either from the VMCB or from the VMCB state cache, as specified by the value of the VMCB Clean field in the VMCB. Support for VMCB state caching is indicated by CPUID Fn8000\_000A\_EDX[VmcbClean] = 1.

The SVM architecture uses the physical address of the VMCB as a unique identifier for the guest virtual CPU for the purposes of deciding whether the cached copy belongs to the guest. For the purposes of VMCB state caching, the ASID is not a unique identifier for a guest virtual CPU.

### 15.15.1 VMCB Clean Bits

The VMCB Clean field (VMCB offset 0C0h, bits 31:0) controls which guest register values are loaded from the VMCB state cache on VMRUN. Each set bit in the VMCB Clean field allows the processor to load one guest register or group of registers from the hardware cache; each clear bit requires that the processor load the guest register from the VMCB. The clean bits are a hint, since any given processor implementation may ignore bits that are set to 1 on any given VMRUN, unconditionally loading the associated register value(s) from the VMCB. Clean bits that are set to zero are always honored.

This field is backward-compatible to CPUs that do not support VMCB state caching; older CPUs neither cache VMCB state nor read the VMCB Clean field.

Older hypervisors that are not aware of VMCB state caching and obey the SBZ property of undefined VMCB fields will not enable VMCB state caching.

### 15.15.2 Guidelines for Clearing VMCB Clean Bits

The hypervisor must clear specific bits in the VMCB Clean field every time it explicitly modifies the associated guest state in the VMCB. The guest's execution can cause cached state to be updated, but the hypervisor is not responsible for setting VMCB Clean bits corresponding to any state changes caused by guest execution.

The hypervisor must clear the entire VMCB field to 0 for a guest, under the following circumstances:

- This is the first time a particular guest is run.
- The hypervisor executes the guest on a different CPU core than one used the last time that guest was executed.
- The hypervisor has moved the guest's VMCB to a different physical page since the last time that guest was executed.

Failure to clear the VMCB Clean bits to zero in these cases may result in undefined behavior.

The CPU automatically treats the VMCB Clean field as zero on the current VMRUN when the hypervisor executes a guest that is not currently cached. The CPU compares the VMCB physical address against all cached VMCB physical addresses and treats the VMCB Clean field as zero, if no cached VMCB address matches.

SMM software (or any other agent external to the hypervisor that has access to VMCBs) that changes the contents of a VMCB needs to comprehend the clean bits and adjust them accordingly; otherwise the guest may not operate as intended.



### 15.15.3 VMCB Clean Field

The layout of the VMCB Clean field is illustrated in Figure 15-4 below.

Bits	Mnemonic	Description
31:12	—	Reserved
11	AVIC	AVIC APIC_BAR; AVIC APIC_BACKING_PAGE, AVIC PHYSICAL_TABLE and AVIC LOGICAL_TABLE Pointers
10	LBR	DbgCtlMsr, br_from/to, lastint_from/to
9	CR2	CR2
8	SEG	CS/DS/SS/ES Sel/Base/Limit/Attr, CPL
7	DT	GDT/IDT Limit and Base
6	DRx	DR6, DR7
5	CRx	CR0, CR3, CR4, EFER
4	NP	Nested Paging: NCR3, PAT, Nested_Paging_En
3	TPR	V_TPR, V_IRQ, V_INTR_PRIO, V_IGN_TPR, V_INTR_MASKING, V_INTR_VECTOR (Offset 60h–67h)
2	ASID	ASID
1	IOPM	IOMSRPM: IOPM_BASE, MSRPM_BASE
0	I	Intercepts: all the intercept vectors, TSC offset, Pause Filter Count

**Figure 15-4. Layout of VMCB Clean Field**

Bits 31:12 are reserved for future implementations. For forward compatibility, if the hypervisor has not modified the VMCB, the hypervisor may write FFFF\_FFFFh to the VMCB Clean Field to indicate that it has not changed any VMCB contents other than the fields described below as explicitly uncached. The hypervisor should write 0h to indicate that the VMCB is new or potentially inconsistent with the CPU's cached copy, as occurs when the hypervisor has allocated a new location for an existing VMCB from a list of free pages and does not track whether that page had recently been used as a VMCB for another guest. If any VMCB fields (excluding explicitly uncached fields) have been modified, all clean bits that are undefined (within the scope of the hypervisor) must be cleared to zero.

The following are explicitly not cached and not represented by Clean bits:

- TLB\_Control
- Interrupt shadow
- VMCB status fields (Exitcode, EXITINFO1, EXITINFO2, EXITINTINFO, Decode Assist, etc.)
- Event injection
- RFLAGS, RIP, RSP, RAX

## 15.16 TLB Control

TLB entries are tagged with *Address Space Identifier* (ASID) bits to distinguish different guest virtual address spaces when shadow page tables are used, or different guest physical address spaces when nested page tables are used.. The VMM can choose a software strategy in which it keeps multiple shadow page tables, and/or multiple nested page tables in processors that support nested paging, up-to-date; the VMM can allocate a different ASID for each shadow or nested page table. This allows switching to a new process in a guest under shadow paging (changing CR3 contents), or to a new guest under nested paging (changing nCR3 contents), without flushing the TLBs. (See Section 15.25, “Nested Paging,” on page 491 for a complete explanation of nested paging operation.)

With shadow paging, the VMM is responsible for setting up a shadow page table for each guest linear address space that maps it to system physical addresses. These are used as the active page tables in place of the guest OS's page tables. The VMM sets the CR3 field in the guest VMCB to point to the system physical address of the desired shadow page table. The VMM is responsible for updating the shadow page table when the guest changes its page table or paging control state, and the VMM updates the access and dirty bits of the guest page table.

The VMRUN instruction and #VMEXIT write the CR0, CR3, CR4 and EFER registers — these writes do *not* flush the TLB. The VMM is responsible for explicitly invalidating any guest translations that may be affected by its actions; there are two mechanisms available, as described in the next two sections.

When running with SVM enabled, global page table entries (PTEs) are global only *within* an ASID, not across ASIDs.

**Software Rule.** When the VMM changes a guest's paging mode by changing entries in the guest's VMCB, the VMM must ensure that the guest's TLB entries are flushed from the TLB. The relevant VMCB state includes:

- CR0—PG, WP, CD, NW.
- CR3—Any bit.
- CR4—PGE, PAE, PSE.
- EFER—NXE, LMA, LME.

### 15.16.1 TLB Flush

TLB flush operations function identically whether or not SVM is enabled (e.g., MOV-TO-CR3 flushes non-global mappings, whereas MOV-TO-CR4 flushes global and non-global mappings). TLB flush operations must not be assumed to affect all ASIDs. If a VMM sets the intercept bit for any guest action that would have flushed the TLB, the #VMEXIT intercept occurs and the TLB is not flushed; it is the VMM's responsibility to flush the TLB appropriately. In implementations that do not provide a way to selectively flush all translations of a single specified ASID, software may effectively flush the guest's TLB entries by allocating a new ASID for the guest and not reusing the old ASID until the entire TLB has been flushed at least once.

The TLB\_CONTROL field in the VMCB provides the commands specified by the control byte encodings shown in Table 15-9. The first two commands are available on all processors that support SVM; support for the other commands is optional and is indicated by CPUID Fn8000\_000A\_EDX[FlushByAsid] = 1.

**Table 15-9. TLB Control Byte Encodings**

Encoding	Function Definition
00h	Do not flush
01h	Flush entire TLB (Should be used only by legacy hypervisors.)
03h	Flush this guest's TLB entries
07h	Flush this guest's non-global TLB entries
Note: All encodings not defined in this table are reserved.	

When the VMM sets the TLB\_CONTROL field to 1, the VMRUN instruction flushes the TLB for all ASIDs, for both global and non-global pages. The VMRUN instruction reads, but does not change, the value of the TLB\_CONTROL field.

A MOV-to-CR3, a task switch that changes CR3, or clearing or setting CR0.PG or bits PGE, PAE, PSE of CR4 affects only the TLB entries belonging to the current ASID, regardless of whether the operation occurred in host or guest mode. The current ASID is 0 when the CPU is not inside a guest context.

All TLB entries belonging to all ASIDs are flushed by SMI, RSM, MTRR modifications, IORR modifications, and access to other system MSRs that affect address translation.

If a hypervisor modifies a nested page table by decreasing permission levels, clearing present bits, or changing address translations and intends to return to the same ASID, it should use either TLB command 011b or 001b.

### 15.16.2 Invalidate Page, Alternate ASID

The INVLPGA instruction allows the VMM to selectively invalidate the TLB mapping for a given guest virtual page within a given ASID. The linear address is specified in the implicit register operand rAX; the ASID is specified in ECX. The input address is always interpreted as a guest virtual address, so INVLPGA is typically meaningful only when used with shadow page tables; it does not provide a means to invalidate a nested translation by guest physical address.

## 15.17 Global Interrupt Flag, STGI and CLGI Instructions

The global interrupt flag (GIF) is a bit that controls whether interrupts and other events can be taken by the processor. The STGI and CLGI instructions set and clear, respectively, the GIF. Table 15-10 shows how the value of the GIF affects how interrupts and exceptions are handled. Implementations may

provide hardware support for virtualizing the GIF in nested virtualization scenarios; see section 15.33, Nested Virtualization, for details.

**Table 15-10. Effect of the GIF on Interrupt Handling**

Interrupt source	GIF==0	GIF ==1
Debug exception or trap, due to breakpoint register match	Ignored and discarded	Normal operation
Debug trace trap due to EFLAGS.TF	Normal operation	Normal operation
RESET	Normal operation	Normal operation
INIT	Held pending until GIF==1	Normal operation, see Table 15-12 on page 481
NMI	Held pending until GIF==1	Normal operation, see Table 15-13 on page 481
External SMI	Held pending until GIF==1	Normal operation, see Table 15-14 on page 482
Internal SMI (I/O Trapping)	Ignored and discarded	Normal operation, see Table 15-14 on page 482
INTR and vINTR	Held pending until GIF==1	Normal operation
#SX (Security Exception)	n/a <sup>1</sup>	Normal operation
Machine Check	If possible (implementation-dependent), held pending until GIF==1, otherwise shutdown.	Normal operation
DBREQ# (enter HDT)	Normal operation	Normal operation
	(VM_CR.DPD always controls DBREQ)	
A20M	Normal operation	Normal operation
	(VM_CR.DIS_A20M controls A20 masking)	
Other implementation-specific but non-architecturally-visible interrupts (STPCLK, IGNNE toggle, ECC scrub)	Normal operation	Normal operation
<b>Note:</b>		
1. #SX is caused only by an INIT signal that has been “redirected” (i.e., converted to an #SX; see Section 15.28 on page 503); the conversion only happens when GIF==1, as the INIT is simply held pending otherwise.		

## 15.18 VMSCALL Instruction

This instruction is meant as a way for a guest to explicitly call the VMM. No CPL checks are performed, so the VMM can decide whether to make this instruction legal at the user-level or not.

If VMSCALL instruction is not intercepted, the instruction raises a #UD exception.

## 15.19 Paged Real Mode

To facilitate virtualization of real mode, the VMRUN instruction may legally load a guest CR0 value with PE = 0 but PG = 1. Likewise, the RSM instruction is permitted to return to paged real mode. This processor mode behaves in every way like real mode, with the exception that paging is applied. The intent is that the VMM run the guest in paged-real mode at CPL0, and with page faults intercepted. The VMM is responsible for setting up a shadow page table that maps guest *physical* memory to the appropriate system physical addresses.

The behavior of running a guest in paged real mode without intercepting page faults to the VMM is undefined.

## 15.20 Event Injection

The VMM can inject exceptions or interrupts (collectively referred to as events) into the guest by setting bits in the VMCB's EVENTINJ field prior to executing the VMRUN instruction. The format of the field is shown in Table 15-5 on page 477. The encoding matches that of the EXITINTINFO field. When an event is injected by means of this mechanism, the VMRUN instruction causes the guest to take the specified exception or interrupt unconditionally before executing the first guest instruction.

Injected events are treated in every way as though they had occurred normally in the guest (in particular, they are recorded in EXITINTINFO) with the following exceptions:

- Injected events are not subject to intercept checks. (Note, however, that if secondary exceptions occur during delivery of an injected event, those exceptions *are* subject to exception intercepts.)
- An injected NMI does not block delivery of further NMIs.
- If the VMM attempts to inject an event that is impossible for the guest mode (e.g., a #BR exception when the guest is in 64-bit mode), the event injection will fail and no guest state instructions will be executed; VMRUN will immediately exit with an error code of VMEXIT\_INVALID.
- Injecting an exception (TYPE = 3) with vectors 3 or 4 behaves like a trap raised by INT3 and INTO instructions, respectively, in which case the processor checks the DPL of the IDT descriptor before dispatching to the handler.
- Software interrupts cannot be properly injected if the processor does not support the NextRIP field. Support is indicated by CPUID Fn8000\_000A\_EDX[NRIPS] = 1. Hypervisor software should emulate the event injection of software interrupts if NextRIP is not supported.
- Event injection does not support injection of intercepted #DB faults that are the result of a guest ICEBP instruction. ICEBP does not perform DPL checks, as does INT $n$  injection. Hypervisor software should emulate the injection of ICEBP.

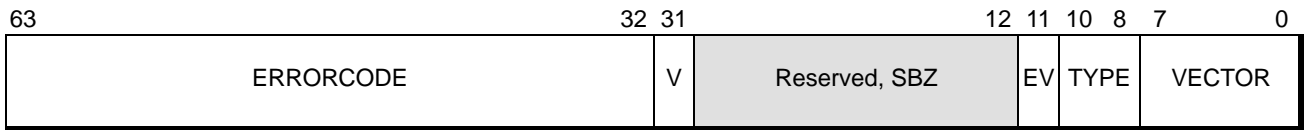

**Figure 15-5. EVENTINJ Field in the VMCB**

The fields in EVENTINJ are as follows:

- *VECTOR*—Bits 7:0. The 8-bit IDT vector of the interrupt or exception. If TYPE is 2 (NMI), the VECTOR field is ignored.
- *TYPE*—Bits 10:8. Qualifies the guest exception or interrupt to generate. Table 15-11 shows possible values and their corresponding interrupt or exception types. Values not indicated are unused and reserved.

**Table 15-11. Guest Exception or Interrupt Types**

Value	Type
0	External or virtual interrupt (INTR)
2	NMI
3	Exception (fault or trap)
4	Software interrupt (INT $n$ instruction)

- *EV (Error Code Valid)*—Bit 11. Set to 1 if the exception should push an error code onto the stack; clear to 0 otherwise.
- *V (Valid)*—Bit 31. Set to 1 if an event is to be injected into the guest; clear to 0 otherwise.
- *ERRORCODE*—Bits 63:32. If EV is set to 1, the error code to be pushed onto the stack, ignored otherwise.

VMRUN exits with VMEXIT\_INVALID if either:

- Reserved values of TYPE have been specified, or
- TYPE = 3 (exception) has been specified with a vector that does not correspond to an exception (this includes vector 2, which is an NMI, not an exception).

## 15.21 Interrupt and Local APIC Support

SVM hardware support is designed to ensure efficient virtualization of interrupts.

### 15.21.1 Physical (INTR) Interrupt Masking in EFLAGS

To prevent the guest from blocking maskable interrupts (INTR), SVM provides a VMCB control bit, V\_INTR\_MASKING, which changes the operation of EFLAGS.IF and accesses to the TPR by means of the CR8 register. While running a guest with V\_INTR\_MASKING cleared to zero:

- EFLAGS.IF controls both virtual and physical interrupts.

While running a guest with V\_INTR\_MASKING set to 1:

- The host EFLAGS.IF at the time of the VMRUN is saved and controls physical interrupts while the guest is running.
- The guest value of EFLAGS.IF controls virtual interrupts only.

### 15.21.2 Virtualizing APIC.TPR

SVM provides a virtual TPR register, V\_TPR, for use by the guest; its value is loaded from the VMCB by VMRUN and written back to the VMCB by #VMEXIT. The APIC's TPR always controls the task priority for physical interrupts, and the V\_TPR always controls virtual interrupts.

While running a guest with V\_INTR\_MASKING cleared to 0:

- Writes to CR8 affect both the APIC's TPR and the V\_TPR register.
- Reads from CR8 operate as they would without SVM.

While running a guest with V\_INTR\_MASKING set to 1:

- Writes to CR8 affect only the V\_TPR register.
- Reads from CR8 return V\_TPR.

### 15.21.3 TPR Access in 32-Bit Mode

The mechanism for TPR virtualization described in section 15.21.2 applies only to accesses that are performed using the CR8 register. However, in 32-bit mode, the TPR is traditionally accessible only by using a memory-mapped register. Typically, a VMM virtualizes such TPR accesses by not mapping the APIC page addresses in the guest. A guest access to that region then causes a #PF intercept to the VMM, which inspects the guest page tables to determine the physical address and, after recognizing the physical address as belonging to the APIC, finally invokes software emulation code.

To improve the efficiency of TPR accesses in 32-bit mode, SVM makes CR8 available to 32-bit code by means of an alternate encoding of MOV TO/FROM CR8 (namely, MOV TO/FROM CR0 with a LOCK prefix). To achieve better performance, 32-bit guests should be modified to use this access method, instead of the memory-mapped TPR. (For details, see “MOV CRn” on page 377 of the *AMD64 Programmer's Reference Volume 3: General Purpose and System Instructions*, order# 24594.)

The alternate encodings of the MOV TO/FROM CR8 instructions are available even if SVM is disabled in EFER.SVME. They are available in both 64-bit and 32-bit mode.

### 15.21.4 Injecting Virtual (INTR) Interrupts

Virtual Interrupts allow the host to pass an interrupt (#INTR) to a guest. While inside a guest, the virtual interrupt follows the same rules that a real interrupt follows (virtual #INTR is not taken until EFLAGS.IF is 1, the guest's TPR has enabled interrupts at the same priority as that of the pending virtual interrupt).

SVM provides an efficient mechanism by which the VMM can inject virtual interrupts into a guest:

- As described in Section 15.13.1, the VMM can intercept physical interrupts that arrive while a guest is running, by activating the INTR intercept in the VMCB.
- As described in Section 15.21.4, the VMM can virtualize the interrupt masking logic by setting the V\_INTR\_MASKING bit in the VMCB.
- The three VMCB fields V\_IRQ, V\_INTR\_PRIO, and V\_INTR\_VECTOR indicate whether there is a virtual interrupt pending, and, if so, what its vector number and priority are. The VMRUN instruction loads this information into corresponding on-chip registers.
- The processor takes a virtual INTR interrupt if
  - V\_IRQ and V\_INTR\_PRIO indicate that there is a virtual interrupt pending whose priority is greater than the value in V\_TPR,
  - interrupts are enabled in EFLAGS.IF,
  - interrupts are enabled using GIF, and
  - the processor is not in an interrupt shadow (see Section 15.21.5 on page 479).

The only other difference between virtual INTR handling and normal interrupt handling is that, in the latter case, the interrupt vector is obtained from the V\_INTR\_VECTOR register (as opposed to running an INTACK cycle to the local APIC).

- The V\_IGN\_TPR field in the VMCB can be set to indicate that the currently pending virtual interrupt is not subject to masking by TPR. The priority comparison against V\_TPR is omitted in this case. This mechanism can be used to inject ExtINT-type interrupts into the guest.
- When the processor dispatches a virtual interrupt (through the IDT), V\_IRQ is cleared after checking for intercepts of virtual interrupts and before the IDT is accessed.
- On #VMEXIT, V\_IRQ is written back to the VMCB, allowing the VMM to track whether a virtual interrupt has been taken.
- Physical interrupts take priority over virtual interrupts, whether they are taken directly or through a #VMEXIT.
- On #VMEXIT, the processor clears its internal copies of V\_IRQ and V\_INTR\_MASKING, so virtual interrupts do not remain pending in the VMM, and interrupt control reverts to normal.

### 15.21.5 Interrupt Shadows

The x86 architecture defines the notion of an *interrupt shadow*—a single-instruction window during which interrupts are not recognized. For example, the instruction after an STI instruction that sets EFLAGS.IF (from zero to one) does not recognize interrupts or certain debug traps. The VMCB INTERRUPT\_SHADOW field indicates whether the guest is currently in an interrupt shadow. This information is saved on #VMEXIT and loaded on VMRUN.

### 15.21.6 Virtual Interrupt Intercept

When virtualizing interrupt handling, a VMM typically needs only gain control when new interrupts for a guest arrive or are generated, and when the guest issues an EOI (end-of-interrupt). In some



circumstances, it may also be necessary for the VMM to gain control at the moment interrupts become enabled in the guest (i.e., just before the guest takes a virtual interrupt). The VMM can do so by enabling the VINTR intercept.

### 15.21.7 Interrupt Masking in Local APIC

When guests have direct access to devices, interrupts arriving at the local APIC can usually be dismissed only by the guest that owns the device causing the interrupt. To prevent one guest from blocking other guests' interrupts (by never processing their own), the VMM can mask pending interrupts in the local APIC, so they do not participate in the prioritization of other interrupts.

SVM introduces the following APIC features:

- A 256-bit IER (interrupt enable) register is added to the local APIC. This register resets to all ones (enabling all 256 vectors). Software can read and write the IER by means of the memory-mapped APIC page.
- Only vectors that are enabled in the IER participate in the APIC computation of the highest-priority pending interrupt.
- The VMM can issue specific end-of-interrupt (EOI) commands to the local APIC, allowing the VMM to clear pending interrupts in any order, rather than always targeting the interrupt with highest-priority.

### 15.21.8 INIT Support

The INIT signal interrupts the processor at the next instruction boundary and causes an unconditional control transfer. INIT reinitializes the control registers, segment registers and GP registers in a manner similar to RESET, but does not alter the contents of most MSRs, caches or numeric coprocessor (x87 or SSE) state, and then transfers control to the same instruction address as RESET (physical address FFFFFFF0h). Unlike RESET, INIT is not expected to be visible to the memory controller, and hence will not trigger automatic clearing of trusted memory pages by memory controller hardware.

To maintain the security of such pages, the VMM can request that INITs be redirected and turned into #SX exceptions by setting the R\_INIT bit in the VM\_CR MSR (see Section 15.30.1, “VM\_CR MSR (C001\_0114h),” on page 524). This allows the VMM to gain control when an INIT is requested. The VMM may thus disable the redirection of INIT and then cause the platform to reassert INIT, at which point the processor will respond in the normal manner. The actions initiated by the INIT pin may also be initiated by an incoming APIC INIT interrupt; the mechanisms described here apply in either case. Table 15-12 summarizes the handling of INITs.

**Table 15-12. INIT Handling in Different Operating Modes**

GIF	INIT Intercept	INIT Redirect	Processor Response to INIT
0	x	x	Hold pending until GIF = 1.

**Table 15-12. INIT Handling in Different Operating Modes**

GIF	INIT Intercept	INIT Redirect	Processor Response to INIT
1	1	x	#VMEXIT(INIT), INIT is still pending.
	0	0	Taken normally.
		1	#SX, INIT is no longer pending.

### 15.21.9 NMI Support

The VMM can intercept non-maskable interrupts (NMI) using a VMCB control bit (see Table 15-13). When intercepted, NMIs cause an exit from the guest and are held pending.

**Table 15-13. NMI Handling in Different Operating Modes**

GIF	NMI Intercept	Processor Response to NMI
0	X	Hold pending until GIF=1.
1	1	#VMEXIT(NMI), NMI is still pending.
	0	Taken normally.

## 15.22 SMM Support

This section describes SVM support for virtualization of System Management Mode (SMM).

### 15.22.1 Sources of SMI

Various events can cause an assertion of a system management interrupt (SMI); these are classified into three categories

- Internal, synchronous (also known as I/O Trapping)—implementation-specific IOIO or config space trapping in the CPU itself; always synchronous in response to an IN or OUT instruction. I/O Trapping is set up by means of MSRs and can be brought under the control of the VMM by intercepting guest access to those MSRs.
- External, synchronous—IOIO trapping in response to (and synchronous with) IN or OUT instructions, but generated by an external agent (typically the Southbridge).
- External, asynchronous—generated externally in response to an external, physical event, e.g., closing a laptop lid, temperature sensor triggering, etc.

### 15.22.2 Response to SMI

How hardware responds to SMIs is a function of whether SMM interrupts are being intercepted and whether interrupts are enabled globally, as shown in Table 15-14.

**Table 15-14. SMI Handling in Different Operating Modes**

GIF	Intercept SMI	Internal SMI	External SMI
0	x	Lost.	Hold pending until GIF=1.
1	1	Exit guest, code #VMEXIT(SMI), SMI is not pending.	#VMEXIT(SMI), SMI is still pending.
	0	Taken normally.	Taken normally.

By intercepting SMIs, the VMM can gain control before the processor enters SMM.

### 15.22.3 Containerizing Platform SMM

In some usage scenarios, the VMM may not trust the existing platform SMM code, or may otherwise want to ensure that the SMM does not operate in the context of certain guests or the hypervisor. To address these cases, SVM provides the ability to *containerize* SMM code, i.e., run it inside a guest, with the full protection mechanisms of the VMM in place. In other scenarios, the VMM may not want to exert control over SMM.

There are three solutions for the VMM to control SMM handlers:

- The simplest solution is to not intercept SMI signals. SMIs encountered while in a guest context are taken from within the guest context. In this case, the SMM handler is not subject to any intercepts set up by the VMM and consequently runs outside of the virtualization controls. The state saved in the SMM State-Save area as seen by the SMM handler reflects the state of the guest that had been running at the time the SMI was encountered. When the SMM handler executes the RSM instruction, the processor returns to executing in the guest context, and any modifications to the SMM State-Save area made by the SMM handler are reflected in the guest state.
- A hypervisor may want to emulate all SMI-based I/O interceptions for a guest and to take SMI signals only in the hypervisor context. The hypervisor should set all IOIO intercept bits and the SMI intercept bit for the guest to ensure that there is no possibility of encountering synchronous (internal or external) SMI signals while running the guest. Any #VMEXIT(SMI) encountered is then known to be due to an external, asynchronous SMI. The hypervisor may respond to the #VMEXIT(SMI) by executing the STGI instruction, which causes the pending SMI to be taken immediately. When an SMI due to an I/O instruction is pending, the effect of executing STGI in the hypervisor is undefined. To handle a pending SMI due to an I/O instruction, the hypervisor must either containerize SMM or not intercept SMI.
- The most involved solution is to containerize SMM by placing it in a guest. Containerizing gives the VMM full control over the state that the SMM handler can access.

**Containerizing Platform SMM.** A VMM can containerize SMM by creating its own trusted SMM hypervisor and use that handler to run the platform SMM code in a container. The SMM hypervisor may be the same code as the VMM itself, or may be an entirely different set of code. The trusted SMM hypervisor sets up a guest context to run the platform SMM as a guest. The guest context consists of a VMCB and related state and the guest's (real or virtual) SMM save area. The SMM hypervisor

emulates SMM entry, including setup of the SMM save area, and emulates RSM at the end of SMM operation. The guest executes the platform SMM code in paged real mode with appropriate SVM intercepts in place, thus ensuring security.

For this approach to work, the VMM may need to write the SMM\_BASE MSR, as well as related SMM control registers. As part of the emulation of SMM entry and RSM, the VMM needs to access the SMM\_CTL MSR (see Section 15.30.3, “SMM\_CTL MSR (C001\_0116h),” on page 525). However, these actions conflict with any platform firmware that locks SMM control registers.

A VMM can determine if it is running with a compatible firmware setup by checking the SMMLOCK bit in the HWCR MSR (described in the *BIOS and Kernel Developer's Guide* applicable to your product). If the bit is 1, firmware has locked the SMM control registers and the VMM is unable to move them or insert its own SMM hypervisor.

As the processor physically enters SMM, the SMRAM regions are remapped. The VMM design must ensure that none of its code or data disappears when the SMRAM areas are mapped or unmapped. Also note that the ASEG region of the SMRAM overlaps with a portion of video memory, so the SMM hypervisor should not attempt to write diagnostic messages to the screen. Any attempt by guests to relocate any of the SMRAM areas (by means of certain MSR writes) must also be intercepted to prevent malicious SMM code from interfering with VMM operation.

Writes to the SMM\_CTL MSR cause a #GP if firmware has locked the SMM control registers.

## 15.23 Last Branch Record Virtualization

The debug control MSR (DebugCtl) provides control of control-transfer recording and other debug facilities. (See Chapter 13, “Software Debug and Performance Resources,” on page 347, for more information on using the debug control MSR.) Software sets the last-branch record (DebugCtl[LBR]) bit to 1 to cause the processor to record the source and target addresses of the last control transfer taken before a debug exception. These control transfers include branch instructions, interrupts, and exceptions. Recorded information is stored in four MSRs:

- LastBranchFromIP
- LastBranchToIP
- LastIntFromIP
- LastIntToIP

Under SVM, to virtualize the function of these MSRs, the VMM must save the contents of the control-transfer recording MSRs on #VMEXIT and restore them prior to the VMRUN for each guest. If control-transfer recording is to be used in host state as well the values of these registers must be exchanged between values tracked by host and guest.

### 15.23.1 Hardware Acceleration for LBR Virtualization

Processors optionally support hardware acceleration for LBR virtualization. The following fields are allocated in the VMCB state save area to hold the contents of the DebugCTL and control-transfer recording MSRs:

- **DBGCTL**—Holds the guest value of the DebugCTL MSR.
- **BR\_FROM**—Holds the guest value of the LastBranchFromIP MSR.
- **BR\_TO**—Holds the guest value of the LastBranchToIP MSR.
- **LASTEXCPFROM**—Holds the guest value of the LastIntFromIP MSR.
- **LASTEXCPTO**—Holds the guest value of the LastIntToIPLastIntToIP MSR.

When **VMCB.LBR\_VIRTUALIZATION\_ENABLE** is set, **VMRUN** saves all five host control-transfer MSRs in the host save area, and then loads the same five MSRs for the guest from the VMCB save area. Similarly, **#VMEXIT** saves the guest's MSRs and loads the host's MSRs to and from their respective save areas.

### 15.23.2 LBR Virtualization CPUID Feature Detection

**CPUID Fn8000\_000A\_EDX[LbrVirt] = 1** indicates support for the LBR virtualization acceleration feature on AMD64 processors. See Section 3.3, “Processor Feature Identification,” on page 63 for more information on using the CPUID instruction.

## 15.24 External Access Protection

By securing the virtual address translation mechanism, the VMM can restrict guest CPU accesses to memory. However, should the guest have direct access to DMA-capable devices, an additional protection mechanism is required. SVM provides multiple protection domains which can restrict device access to physical memory on a per-page basis. This is accomplished via control logic in the northbridge's host bridge which governs any external access port (e.g., PCI or HyperTransport™ technology interfaces).

### 15.24.1 Device IDs and Protection Domains

The northbridge's host bridge provides a number of protection domains. Each protection domain has associated with it a device exclusion vector (DEV) that specifies the per-page access rights of devices in that domain. Devices are identified by a HyperTransport™ bus/unitID (device ID) and the host bridge contains a lookup table of fixed size that maps device IDs to a protection domain.

### 15.24.2 Device Exclusion Vector (DEV)

A DEV is a contiguous array of bits in physical memory; each bit in the DEV (in little-endian order) corresponds to one 4-Kbyte page in physical memory.

The physical address of the base of a DEV must be 4-Kbyte-aligned and stored in one of the **DEVBASE** registers, which are accessed through an indirection mechanism in the **DEVCTL** PCI

Configuration Space function block in the host bridge (see “DEV Control and Status Registers” on page 488). The DEV protection hardware is not operational until enabled by setting a control bit in the DEV Control Register, also in the DEVCTL function block.

The DEV may have to cover part of MMIO space beyond the DRAM. Especially in 64-bit systems, the operating system should map MMIO space starting immediately after the DRAM area and building up, as opposed to starting down from the maximum physical address.

**Host Bridge and Processor DEV Caching.** For improved performance, the host bridge may cache portions of the DEV. Any such cached information can be invalidated by setting the DEV\_FLUSH flag in the DEV control register to 1. Software must set this flag after modifying DEV contents to ensure that the protection logic uses the updated values. The host bridge automatically clears this flag when the flush operation completes. After setting this flag, software should monitor it until it has cleared, in order to synchronize DEV updates with subsequent activity.

By default, the host bridge probes the processor caches for the latest data when it accesses the DEV in DRAM. However, it is possible to disable probing by means of the DEV\_CR register (see “DEV\_CR Register” on page 488); this is recommended in the case of unified memory architecture (UMA) graphics systems. If cache probing is disabled, host bridge reads of the DEV will not check processor caches for more recent copies. This requires software on the CPU to map the memory containing the DEV as uncacheable (UC) or write-through (WT). Alternatively, software must perform a CLFLUSH before it can expect a change to the DEV to be visible by the northbridge (and before software flushes the DEV cache in the host controller).

**Multiprocessor Issues.** Device-originated memory requests are checked against the DEV at the point of entry to the system—the northbridge to which the device is physically attached. Each northbridge can have its own set of domains, device-to-domain mappings, and DEV tables (e.g., domain #2 on one node can encompass different devices, and can have different access rights than domain #2 on another node). Thus, the number of protection domains available to software can scale with the number of northbridges in the system.

### 15.24.3 Access Checking

**Memory Space Accesses.** When a memory-space read or write request is received on an external host bridge port, the host bridge maps the HyperTransport bus device ID to a protection domain number, which in turn selects the DEV defining the access permissions for the device (see Figure 15-6 on page 486). The host bridge then checks the memory address against the DEV contents by indexing into the DEV with the PFN portion of the address (bits 39:12). The PFN is used as a bit index within the DEV. If the bit read from the DEV is set to 1, the host bridge inhibits the access by returning all ones for the data for a read request, or suppressing the store operation on a write request. A Master Abort error response will be returned to the requesting device.

Peer-to-peer memory accesses routed up to the host bridge are also subjected to checks against the DEV. Peer-to-peer transfers that may be occurring behind bridges are not checked.

DEV checks are applied before addresses are translated by the GART. The DEV table is never consulted by accesses originating in the CPU.

**I/O Space Accesses.** The host bridge can be configured to reject all I/O space accesses from devices, by setting the IOSPE bit in the DEV\_CR control register (see “DEV\_CR Register” on page 488). I/O space peer-to-peer transfers behind bridges are not checked.

**Config Space Accesses.** Major aspects of host bridge functionality are configured by means of control registers that are accessed through PCI configuration space. Because this is potentially accessible by means of device peer-to-peer transfers, the host bridge always blocks access to this space from anything other than the CPU.

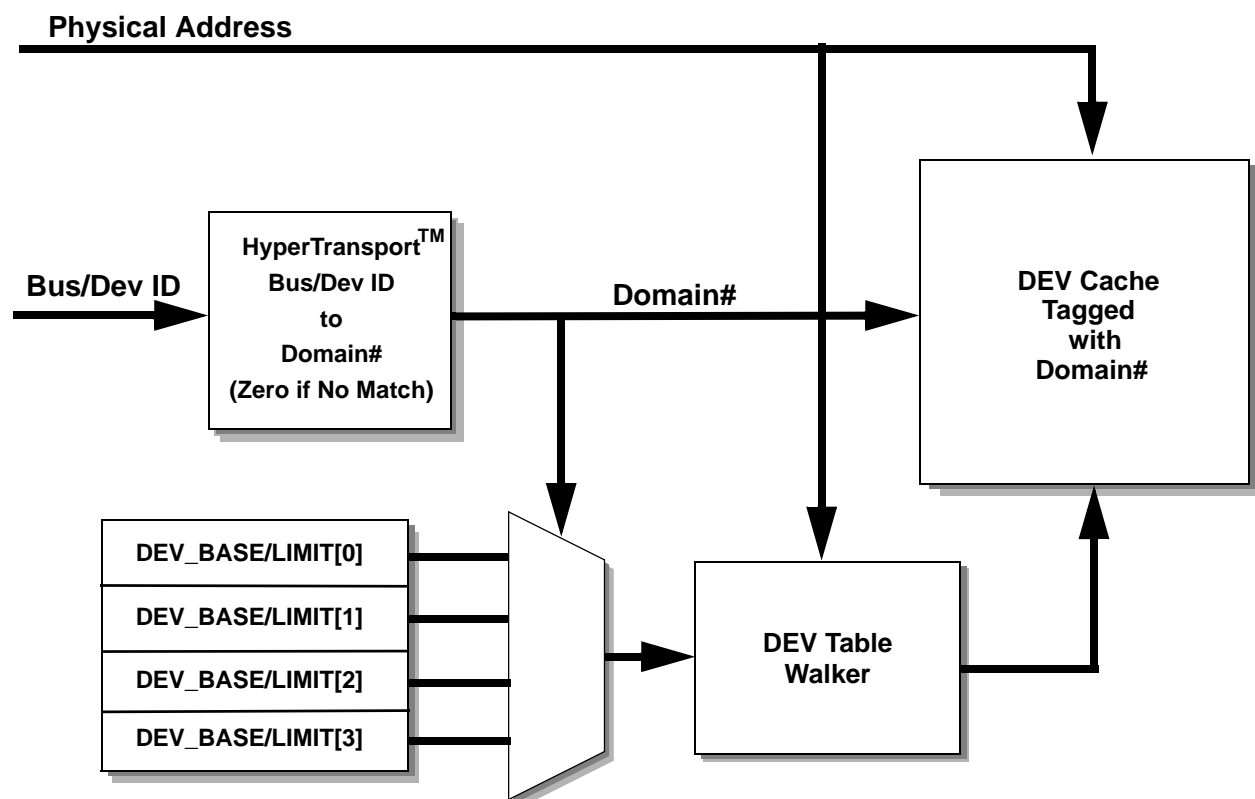

Figure 15-6. Host Bridge DMA Checking

#### 15.24.4 DEV Capability Block

The presence of DEV support is indicated through a new PCI capability block. The capability block also provides access to the registers that control operation of the DEV feature.

The DEV capability block in PCI space contains three 32-bit words: the capability header (DEV\_HDR), and two registers (DEV\_OP and DEV\_DATA) which serve as an indirection mechanism for accessing the actual DEV control and status registers.

**Table 15-15. DEV Capability Block, Overall Layout**

Byte Offset	Register	Comments
0	DEV_HDR	Capability block header
4	DEV_OP	Selects control/status register to access
8	DEV_DATA	Read/write to access register selected in DEV_OP

**DEV Capability Header.** The DEV capability header (DEV\_HDR) is defined in Table 15-16.

**Table 15-16. DEV Capability Header (DEV\_HDR) (in PCI Config Space)**

Bit(s)	Definition
31:22	Reserved, MBZ
21	Interrupt Reporting Capability
20	Machine Check Exception Reporting Capability
19	Reserved, MBZ
18:16	DEV Capability Block Type; hardwired to 000b.
15:8	PCI Capability pointer; points to next capability in list
7:0	PCI Capability ID; hardwired to 0x0F

**15.24.5 DEV Register Access Mechanism**

The northbridge’s DEV control and status registers are accessed through an indirection mechanism: writing the DEV\_OP register selects which internal register is to be accessed, and the DEV\_DATA register can be read or written to access the selected register.

Figure 15-7 shows the format of the DEV\_OP register. The DEV\_DATA register reflects the format of the DEV register selected in DEV\_OP.



**Figure 15-7. Format of DEV\_OP Register (in PCI Config Space)**

The FUNCTION field in the DEV\_OP register selects the function/register to read or write according to the encoding in Table 15-17; for blocks of registers that have multiple instances (e.g., multiple DEV\_BASE\_HI/LO registers), the INDEX field selects the instance; otherwise it is ignored.



**Table 15-17. Encoding of Function Field in DEV\_OP Register**

Function Code	RegisterType	Number of Instances
0	DEV_BASE_LO	multiple
1	DEV_BASE_HI	multiple
2	DEV_MAP	multiple
3	DEV_CAP	single
4	DEV_CR	single
5	DEV_ERR_STATUS	single
6	DEV_ERR_ADDR_LO	single
7	DEV_ERR_ADDR_HI	single

For example, to write the DEV\_BASE\_HI register for protection domain number 2, software sets DEV\_OP.FUNCTION to 1, and DEV\_OP.INDEX to 2, and then writes the desired 32-bit value into DEV\_DATA. As the DEV\_OP and DEV\_DATA registers are accessed through PCI config space (ports 0CF8h–0CFFh), they may be secured from unauthorized access by software executing on the processor by appropriate settings in the SVM I/O protection bitmap. These registers are also protected by the host bridge from external access as described in “Config Space Accesses” on page 486.

#### 15.24.6 DEV Control and Status Registers

The DEV control and status registers are accessible by means of the indirection mechanism; these registers are *not* directly visible in PCI config space.

**DEV\_CAP Register.** Read-only register; holds implementation specific information: the number of protection domains supported, the number of DEV\_MAP registers (which map device/unit IDs to domain numbers), and the revision ID.

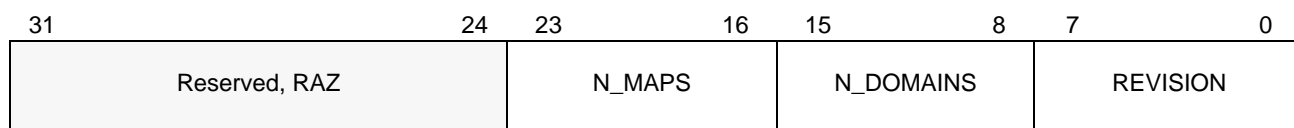
**Figure 15-8. Format of DEV\_CAP Register (in PCI Config Space)**

The initial implementation provide four domains and three map registers.

**DEV\_CR Register.** This is the main control register for the DEV mechanism; it is cleared to zero by RESET.

**Table 15-18. DEV\_CR Control Register**

Bit(s)	Definition
31:7	Reserved, MBZ
6	DEV table walk probe disable. 0 = Use probe on DEV walk; 1 = Do not use probe
5	SL_DEV_EN. Enable bit for limited memory protection, see Section 15.24.8 on page 490. Set to “1” by SKINIT instruction, can be cleared by software.
4	Invalidate DEV cache. Software must set this bit to 1 to invalidate the DEV cache; cleared by hardware when invalidation is complete.
3	Enable MCE reporting. 0 = Do not generate MCE; 1 = Generate MCE on errors.
2	I/O space protection enable (IOSPEN) 0 = Allow upstream I/O cycles; 1 = Block.
1	Memory clear disable. If non-zero, memory-clearing on reset is disabled. This bit is not writable until the memory is enabled.
0	DEV global enable bit. If zero, DEV protection is turned off.

**DEV\_BASE Address/Limit Registers.** The DEV base address registers (one set per domain) each point to the physical address of a DEV table corresponding to a protection domain. The address and size are encoded in a pair (high/low) of 32-bit registers. The N\_DOMAINS field in DEV\_CAP indicates how many (pairs of) DEV\_BASE registers are implemented. The register format is as shown in Figures 15-9 and 15-10.

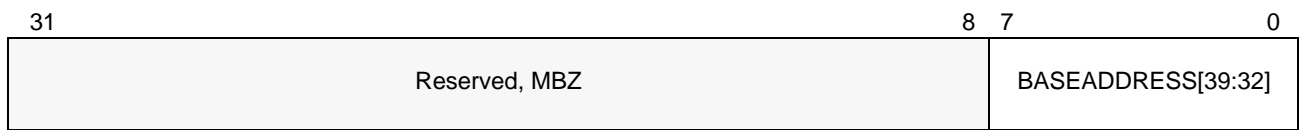

**Figure 15-9. Format of DEV\_BASE\_HI[n] Registers**

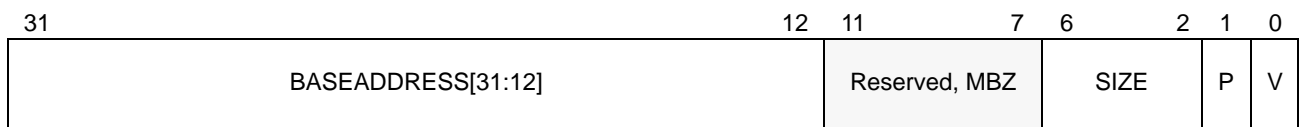

**Figure 15-10. Format of DEV\_BASE\_LO[n] Registers**

Fields of the DEV\_BASE\_HI and DEV\_BASE\_LO registers are defined as follows:

- *Valid (V)*—Bit 0. Indicates whether a DEV table has been defined for the given protection domain; if this bit is clear, software can leave the other fields undefined, and no protection checks are performed for memory references in this domain.

- *Protect (P)*—Bit 1. Indicates whether accesses to addresses beyond the address range covered by the DEV are legal (P=0) or illegal (P=1).
- *SIZE*—Bits 6:2. Specifies how much memory the DEV covers, expressed in increments of 4GB \*  $2^{\text{size}}$ . In other words, a DEV table covers a minimum of 4GB, and can expand by powers of two.

**DEV\_MAP Registers.** The DEV\_MAP registers assign protection domain numbers to device-originated requests by matching the device ID (HT bus and unit number) associated with the request against bus and unit numbers in the registers. If no match is found in any of the registers, a domain number of zero is returned. The number of DEV\_MAP registers implemented by the chip is indicated by the N\_MAPS field in DEV\_CAP.

The format of the DEV\_MAP registers is shown in Figure 15-11.

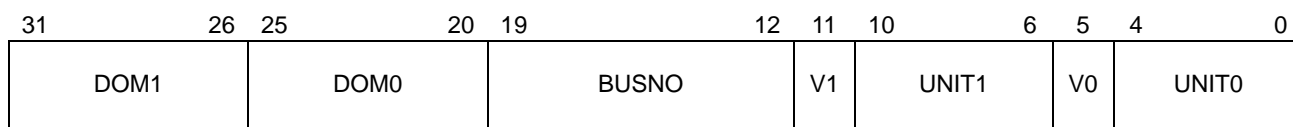

**Figure 15-11. Format of DEV\_MAP[n] Registers**

The fields of the DEV\_MAP[n] registers are defined as follows:

- UNIT0—Bits 4:0. Specifies the first of two HyperTransport link unit numbers on the bus number specified by the BUSNO field.
- V0—Bit 5. Indicates whether UNIT0 is valid (no matches occur on invalid entries).
- UNIT1—Bits 10:6. Specifies the second of two HyperTransport link unit numbers on the bus number specified by the BUSNO field.
- V1—Bit 11. Indicates whether UNIT1 is valid (no matches occur on invalid entries).
- BUSNO—Bits 19:12. Specifies a HyperTransport link bus number.
- DOM0—Bits 25:20. Specifies the protection domain for the first HyperTransport link unit.
- DOM1—Bits 31:26. Specifies the protection domain for the second HyperTransport link unit.

#### 15.24.7 Unauthorized Access Logging

Any attempted unauthorized access by devices to DEV-protected memory is logged by the host bridge in the DEV\_Error\_Status and DEV\_Error\_Address registers for possible inspection by the VMM.

#### 15.24.8 Secure Initialization Support

The host bridge contains additional logic that operates in conjunction with the SKINIT instruction to provide a limited form of memory protection during the secure startup protocol. This provides protection for a Secure Loader image in memory, allowing it to, among other things, set up full DEV protection. (See “Secure Startup with SKINIT” on page 498 for detailed operation of SKINIT.)

The host bridge logic includes a hidden (not accessible to software) SL\_DEV\_BASE address register. SL\_DEV\_BASE points to a 64KB-aligned 64KB region of physical memory. When SL\_DEV\_EN is 1, the 64KB region defined by SL\_DEV\_BASE is protected from external access (as if it were protected by the DEV), as well as from any access (both CPU and external accesses) via GART-translated addresses. Additionally, the SL\_DEV mechanism, when enabled, blocks all device accesses to PCI Configuration space.

## 15.25 Nested Paging

The optional SVM nested paging feature provides for two levels of address translation, thus eliminating the need for the VMM to maintain shadow page tables.

### 15.25.1 Traditional Paging versus Nested Paging

Figure 15-12 on page 491 shows how a page in the linear address space is mapped to a page in the physical address space in traditional (single-level) address translation. Control register CR3 contains the physical address of the base of the page tables (PT, represented by the shaded box in the figure), which governs the address translation.

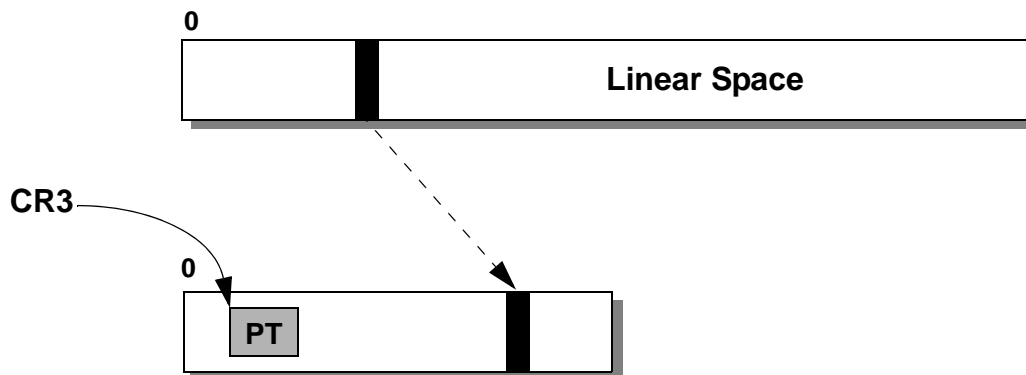
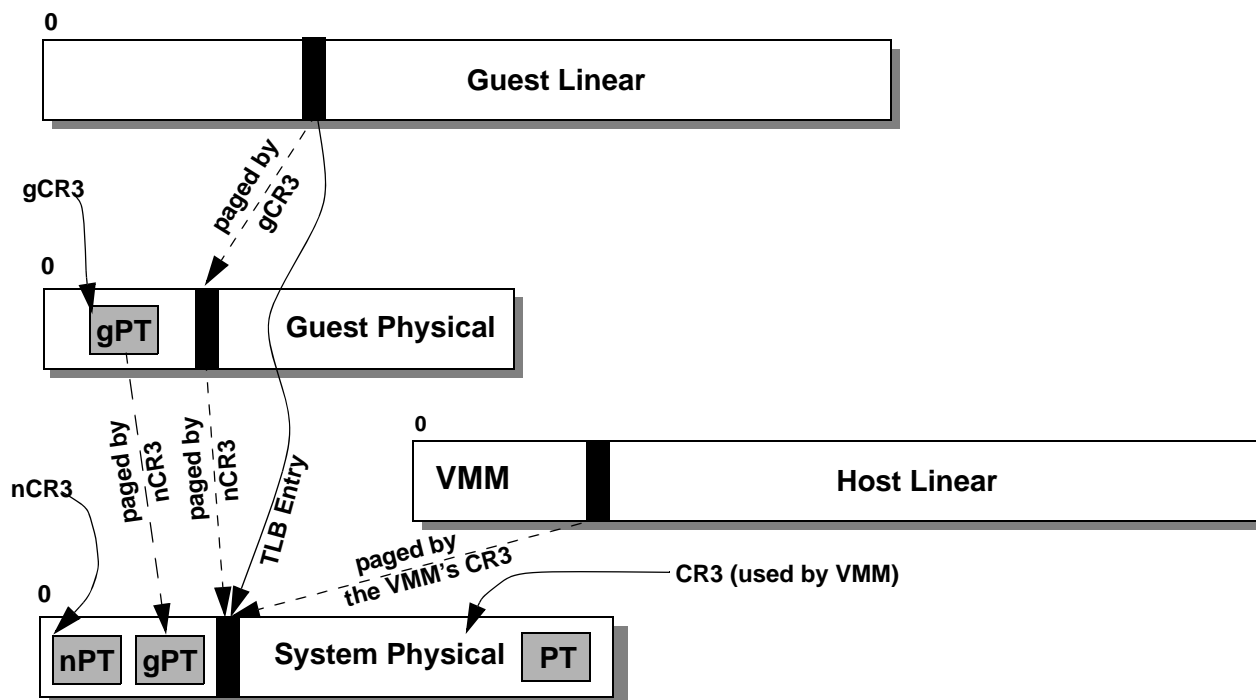

**Figure 15-12. Address Translation with Traditional Paging**

With nested paging enabled, *two* levels of address translation are applied; refer to Figure 15-13 below.

- Both guest and host levels have their own copy of CR3, referred to as gCR3 and nCR3, respectively.
- Guest page tables (gPT) map guest linear addresses to guest physical addresses. The guest page tables are in guest physical memory, and are pointed to by gCR3.
- Nested page tables (nPT) map guest physical addresses to system physical addresses. The nested page tables are in system physical memory, and are pointed to by nCR3.
- The most-recently used translations from guest linear to system physical address are cached in the TLB and used on subsequent guest accesses.

It is important to note that gCR3 and the guest page table entries contain guest physical addresses, not system physical addresses. Hence, before accessing a guest page table entry, the table walker first translates that entry's guest physical address into a system physical address.



**Figure 15-13. Address Translation with Nested Paging**

The VMM can give each guest a different ASID, so that TLB entries from different guests can coexist in the TLB. The ASID value of zero is reserved for the host; if the VMM attempts to execute VMRUN with a guest ASID of zero, the result is #VMEXIT(VMEXIT\_INVALID). Note that because an ASID is associated with the guest's physical address space, it is common across all of the guest's virtual address spaces within a processor. This differs from shadow page tables where ASIDs tag individual guest virtual address spaces. Note also that the same ASID may or may not be associated with the same address space across all processors in a multiprocessor system, for either nested tables or shadow tables; this depends on how the VMM manages ASID assignment.

### 15.25.2 Replicated State

Most processor state affecting paging is replicated for host and guest. This includes the paging registers CR0, CR3, CR4, EFER and PAT. CR2 is not replicated but is loaded by VMRUN. The MTRRs are not replicated.

While nested paging is enabled, all (guest) references to the state of the paging registers by x86 code (MOV to/from CR $n$ , etc.) read and write the guest copy of the registers; the VMM's versions of the

registers are untouched and continue to control the second level translations from guest physical to system physical addresses. In contrast, when nested paging is disabled, the VMM's paging control registers are stored in the host state save area and the paging control registers from the guest VMCB are the only active versions of those registers.

### 15.25.3 Enabling Nested Paging

The VMRUN instruction enables nested paging when the NP\_ENABLE bit in the VMCB is set to 1. The VMCB contains the hCR3 value for the page tables for the extra translation. The extra translation uses the same paging mode as the VMM used when it executed the most recent VMRUN.

Nested paging is automatically disabled by #VMEXIT.

Nested paging is allowed only if the host has paging enabled. Support for nested paging is indicated by CPUID Fn8000\_000A\_EDX[NP] = 1. If VMRUN is executed with hCR0.PG cleared to zero and NP\_ENABLE set to 1, VMRUN terminates with #VMEXIT(VMEXIT\_INVALID). See Section 3.3, “Processor Feature Identification,” on page 63 for more information on using the CPUID instruction.

### 15.25.4 Nested Paging and VMRUN/#VMEXIT

When VMRUN is executed with nested paging enabled (NP\_ENABLE = 1), the paging registers are affected as follows:

- VMRUN saves the VMM's CR3 in the host save area.
- VMRUN loads the guest paging state from the guest VMCB into the guest registers (i.e., VMRUN loads CR3 with the VMCB CR3 field, etc.). The guest PAT register is loaded from G\_PAT field in the VMCB.
- VMRUN loads nCR3, the version of CR3 to be used while the nested-paging guest is running, from the N\_CR3 field in the VMCB. The other host paging-control bits (hCR4.PAE, etc.) remain the same as they were in the VMM at the time VMRUN was executed.

When VMRUN is executed with nested paging enabled (NP\_ENABLE = 1), the following conditions are considered illegal state combinations, in addition to those mentioned in “Canonicalization and Consistency Checks” on page 451:

- Any MBZ bit of nCR3 is set.
- Any G\_PAT.PA field has an unsupported type encoding or any reserved field in G\_PAT has a non-zero value. (See Section 7.8.1, “PAT Register,” on page 199.)

When #VMEXIT occurs with nested paging enabled:

- #VMEXIT writes the guest paging state (gCR3, gCR0, etc.) back into the VMCB. nCR3 is not saved back into the VMCB.
- #VMEXIT need not reload any host paging state other than CR3 from the host save area, though an implementation is free to do so.

### 15.25.5 Nested Table Walk

When the guest is running with nested paging enabled, a TLB miss causes several nested table walks:

- Guest Page Tables—the gCR3 register specifies a guest physical address, as do the entries in the guest's page tables. These guest physical addresses must be translated to system physical addresses using the nested page tables. Nested page table level faults can occur on these accesses, including write faults due to setting of accessed and dirty bits in the guest page table.
- Final Guest-Physical Page—once a guest linear to guest physical mapping is known, guest permissions can be checked. If the guest page tables allow the access, the guest physical address is walked in the nested page tables to find the system physical address.

Table walks for guest page tables are always treated as user writes at the nested page table level. For this reason,

- the page must be writable by user at the nested page table level, or else a #VMEXIT(NPF) is raised, and
- the dirty and accessed bits are always set in the nested page table entries that were touched during nested page table walks for guest page table entries.

A table walk for the guest page itself is always treated as a user access at the nested page table level, but is treated as a data read, data write, or code read, depending on the guest access.

If the guest has paging disabled (gCR0.PG = 0), there are no guest page table entries to be translated in the nested page tables. In this case, the final guest-physical address is equal to the guest-linear address, and is still translated in the nested page tables.

### 15.25.6 Nested versus Guest Page Faults, Fault Ordering

In nested paging, page faults can be raised at either the guest or nested page table level. Nested walks proceed in the following order; faults are generated in the same order:

1. Walk the guest page table entries in the nested page table. Dirty/Accessed bits are set as needed in the nested page table. Any nested page table faults result in #VMEXIT(NPF).
2. As the guest page table walk proceeds from the top of the page table to the last entry, any not-present entries or reserved bits in the guest page table entries at each level of the guest walk cause #PF in the guest. Guest dirty and accessed bits are set as needed in the guest page tables during the walk. Steps 1 and 2 are repeated for each level of the guest page table that is traversed.
3. Once the guest physical address for the guest access has been determined, check the guest permissions; any fault at this point causes a #PF in the guest.
4. Perform the final translation from guest physical to system physical using the nested page table; any fault during this translation results in a #VMEXIT(NPF).

Nested page faults are entirely a function of the nested page table and VMM processor mode. Nested faults cause a #VMEXIT(NPF) to the VMM. The faulting guest physical address is saved in the VMCB's EXITINFO2 field; EXITINFO1 delivers an error code similar to a #PF error code:

- Bit 0 (P)—cleared to 0 if the nested page was not present, 1 otherwise
- Bit 1 (RW)—set to 1 if the nested page table level access was a write. Note that host table walks for guest page tables are always treated as data writes.
- Bit 2 (US)—always 1, since all guest accesses are treated as user accesses at the nested level
- Bit 3 (RSV)—set to 1 if reserved bits were set in the corresponding nested page table entry
- Bit 4 (ID)—set to 1 if the nested page table level access was a code read. Note that nested table walks for guest page tables are always treated as data writes, even if the access itself is a code read

In addition, the VMCB contents for nested page faults indicate whether the page fault was encountered during the nested page table walk for a guest page TLB entry, or for the final nested walk for the guest physical address, as indicated by EXITINFO1[33:32]:

- Bit 32—set to 1 if nested page fault occurred while translating the guest’s final physical address
- Bit 33—set to 1 if nested page fault occurred while translating the guest page tables

Guest faults are entirely a function of the guest page tables and processor mode; they are delivered to the guest as normal #PF exceptions without any VMM intervention, unless the VMM is intercepting guest #PF exceptions. Bits 32 and 33 of EXITINFO1 are written during nested page faults to indicate whether the page fault was encountered during the nested page table walk for a guest page table's table entries, or if the fault was encountered during the nested page table walk for the translation of the final guest physical address.

The processor may provide additional instruction decode assist information. (See Section 15.10, “IOIO Intercepts,” on page 461.)

### 15.25.7 Combining Nested and Guest Attributes

Any access to guest physical memory is subjected to a permission check by examining the mapping of the guest physical address in the nested page table.

A page is considered writable by the guest only if it is marked writable at both the guest and nested page table levels. Note that the guest’s gCR0.WP affects only the interpretation of the guest page table entry; setting gCR0.WP cannot make a page writable at any CPL in the guest, if the page is marked read-only in the nested page table. The host hCR0.WP bit is ignored under nested paging.

A page is considered executable by the guest only if it is marked executable at both the guest and nested page table levels. If the EFER.NXE bit is cleared for the guest, all guest pages are executable at the guest level. Similarly, if the EFER.NXE bit is cleared for the host, all nested page table mappings are executable at the underlying nested level.

Some attributes are taken from the guest page tables and operating modes only. A page is considered global within the guest only if is marked global in the guest page tables; the nested page table entry and host hCR4.PGE are irrelevant. Global pages are only global within their ASID.

A page is considered user in the guest only if it is marked as user at the guest level. The page must be marked user in the nested page table to allow any guest access at all.



### 15.25.8 Combining Memory Types, MTRRs

When nested paging is disabled, the processor behaves as though there is no gPAT register.

The host PAT MSR determines memory type attributes for the current VM, and guest writes to the PAT MSR that aren't intercepted by the VMM will alter the host PAT MSR. The hypervisor is responsible for context-switching the PAT MSR contents on world switches between VM's.

When nested paging is enabled, the processor combines guest and nested page table memory types. Registers that affect memory types include:

- The PCD/PWT/PAT<sub>i</sub> bits in the nested and guest page table entries.
- The PCD/PWT bits in the nested CR3 and guest CR3 registers.
- The guest PAT type (obtained by appropriately indexing the gPAT register).
- The host PAT type (obtained by appropriately indexing the host's PAT register).
- The MTRRs (which are referenced based only on system physical address).
- gCR0.CD and hCR0.CD.

Note that there is no hardware support for guest MTRRs; the VMM can simulate their effect by altering the memory types in the nested page tables. Note that the MTRRs are only applied to system physical addresses.

The rules for combining memory types when constructing a guest TLB entry are:

- Nested and guest PAT types are combined according to Table 15-19 on page 497, producing a “combined PAT type.”
- Combined PAT type is further combined with the MTRR type according to Table 15-20 on page 497, where the relevant MTRRs are determined by the system physical address.
- Either gCR0.CD or hCR0.CD can disable caching.

**Memory Consistency Issues.** Because the guest uses extra fields to determine the memory type, the VMM may use a different memory type to access a given piece of memory than does the guest. If one access is cacheable and the other is not, the VMM and guest could observe different memory images, which is undesirable. (MP systems are particularly sensitive to this problem when the VMM desires to migrate a virtual processor from one physical processor to another.)

To address this issue, the following mechanisms are provided:

- VMRUN and #VMEXIT flush the write combiners. This ensures that all writes to WC memory by the guest are visible to the host (or vice-versa) regardless of memory type. (It does not ensure that cacheable writes by one agent are properly observed by WC reads or writes by the other agent.)
- A new memory type WC+ is introduced. WC+ is an uncacheable memory type, and combines writes in write-combining buffers like WC. Unlike WC (but like the CD memory type), accesses to WC+ memory also snoop the caches on all processors (including self-snooping the caches of the processor issuing the request) to maintain coherency. This ensures that cacheable writes are observed by WC+ accesses.

- When combining nested and guest memory types that are incompatible with respect to caching, the WC+ memory type is used instead of WC (and Table 15-20 on page 497 ensures that the snooping behavior is retained regardless of the host MTRR settings). Refer to Table 15-19 on page 497 or details.

Table 15-19 shows how guest and host PAT types are combined into an effective PAT type. When interpreting this table, recall (a) that guest and host PAT types are not combined when nested paging is disabled and (b) that the intent is for the VMM to use its PAT type to simulate guest MTRRs.

**Table 15-19. Combining Guest and Host PAT Types**

		Host PAT Type					
		UC	UC-	WC	WP	WT	WB
Guest PAT Type	UC	UC	UC	UC	UC	UC	UC
	UC-	UC	UC-	WC	UC	UC	UC
	WC	WC	WC	WC	WC+	WC+	WC+
	WP	UC	UC	UC	WP	UC	WP
	WT	UC	UC	UC	UC	WT	WT
	WB	UC	UC	WC	WP	WT	WB

The existing AMD64 table that defines how PAT types are combined with the physical MTRRs is extended to handle CD and WC+ PAT types as shown in Table 15-20.

**Table 15-20. Combining PAT and MTRR Types**

		MTRR Type				
		UC	WC	WP	WT	WB
Effective PAT Type	UC	UC	CD	CD	CD	CD
	UC-	UC	WC	CD	CD	CD
	WC	WC	WC	WC	WC	WC
	WC+	WC	WC	WC+	WC+	WC+
	WP	UC	CD	WP	CD	WP
	WT	UC	CD	CD	WT	WT
	WB	UC	WC	WP	WT	WB

**15.25.9 Page Splintering**

When an address is mapped by guest and nested page table entries with different page sizes, the TLB entry that is created matches the size of the smaller page.

**15.25.10 Legacy PAE Mode**

The behavior of PAE mode in a nested-paging guest differs slightly from the behavior of (host-only) legacy PAE mode, in that the guest’s four PDPEs are not loaded into the processor at the time CR3 is

written. Instead, the PDPEs are accessed on demand as part of a table walk. This has the side-effect that illegal bit combinations in the PDPEs are not signaled at the time that CR3 is written, but instead when the faulty PDPE is accessed as part of a table walk.

This means that an operating system cannot rely on the behavior when the in-memory PDPEs are different than the in-processor copy.

### 15.25.11 A20 Masking

There is no provision for applying A20 masking to guest physical addresses; the VMM can emulate A20 masking by changing the nested page mappings accordingly.

### 15.25.12 Detecting Nested Paging Support

Nested Paging is an optional feature of SVM and is not available in all implementations of SVM-capable processors. The CPUID instruction should be used to detect nested paging support on a particular processor. See Section 3.3, “Processor Feature Identification,” on page 63 for more information on using the CPUID instruction.

## 15.26 Security

SVM provides additional hardware support that is designed to facilitate the construction of trusted software systems. While the security features described in this section are orthogonal to SVM’s virtualization support (and are not required for processor virtualization), the two form building blocks for trusted systems.

**SKINIT Instruction.** The SKINIT instruction and associated system support (the Trusted Platform Module or TPM) are designed to allow for verifiable startup of trusted software (such as a VMM), based on secure hash comparison.

**Security Exception.** A security exception (#SX) is used to signal certain security-critical events.

## 15.27 Secure Startup with SKINIT

The SKINIT instruction is one of the keys to creating a “root of trust” starting with an initially untrusted operating mode. SKINIT reinitializes the processor to establish a secure execution environment for a software component called the secure loader (SL) and starts execution of the SL in a way that cannot be tampered with. SKINIT also copies the secure loader executable image to an external device, such as a Trusted Platform Module (TPM) for verification using unique bus transactions that preclude SKINIT operation from being emulated by software in a way that the TPM could not readily detect. (Detailed operation is described in Section 15.27.4.)

### 15.27.1 Secure Loader

A secure loader (SL) typically initializes SVM hardware mechanisms and related data structures, and initiates execution of a trusted piece of software such as a VMM (referred to as a Security Kernel, or SK, in this document), after first having validated the identity of that software.

SKINIT allows SVM protections to be reliably enabled after the system is already up and running in a non-trusted mode — there is no requirement to change the typical x86 platform boot process.

Exact details of the handoff from the SL to an SK are dependent on characteristics of the SL, SK and the initial untrusted operating environment. However, there are specific requirements for the SL image, as described in Section 15.27.2.

### 15.27.2 Secure Loader Image

The secure loader (SL) image contains all code and initialized data sections of a secure loader. This code and initial data are used to initialize and start a security kernel in a completely safe manner, including setting up DEV protection for memory allocated for use by SL and SK. The SL image is loaded into a region of memory called the secure loader block (SLB) and can be no larger than 64Kbyte (see “Secure Loader Block” on page 499). The SL image is defined to start at byte offset 0 in the SLB.

The first word (16 bits) of the SL image must specify the SL entry point as an unsigned offset into the SL image. The second word must contain the length of the image in bytes; the maximum length allowed is 65535 bytes. These two values are used by the SKINIT instruction. The layout of the rest of the image is determined by software conventions. The image typically includes a digital signature for validation purposes. The digital signature hash must include the entry point and length fields. SKINIT transfers the SL image to the TPM for validation prior to starting SL execution (see “SKINIT Operation” on page 501 for further details of this transfer). The SL image for which the hash is computed must be ready to execute without prior manipulation.

### 15.27.3 Secure Loader Block

The secure loader block is a 64Kbyte range of physical memory which may be located at any 64Kbyte-aligned address below 4Gbyte. The SL image must have been loaded into the SLB starting at offset 0 before executing SKINIT. The physical address of the SLB is provided as an input operand (in the EAX register) to SKINIT, which sets up special protection for the SLB against device accesses (i.e., the DEV need not be activated yet).

The SL must be written to execute initially in flat 32-bit protected mode with paging disabled. A base address can be derived from the value in EAX to access data areas within the SL image using base+displacement addressing, to make the SL code position-independent.

Memory between the end of the SL image and the end of the SLB may be used immediately upon entry by the SL as secure scratch space, such as for an initial stack, before DEV protections are set up for the rest of memory. The amount of space required for this will limit the maximum size of the SL image,

and will depend on SL implementation. SKINIT sets the ESP register to the appropriate top-of-stack value ( $EAX + 10000h$ ).

Figure 15-14 on page 500 illustrates the layout of the SLB, showing where EAX and ESP point after SKINIT execution. Labels in *italics> indicate suggested uses; other labels reflect required items.*

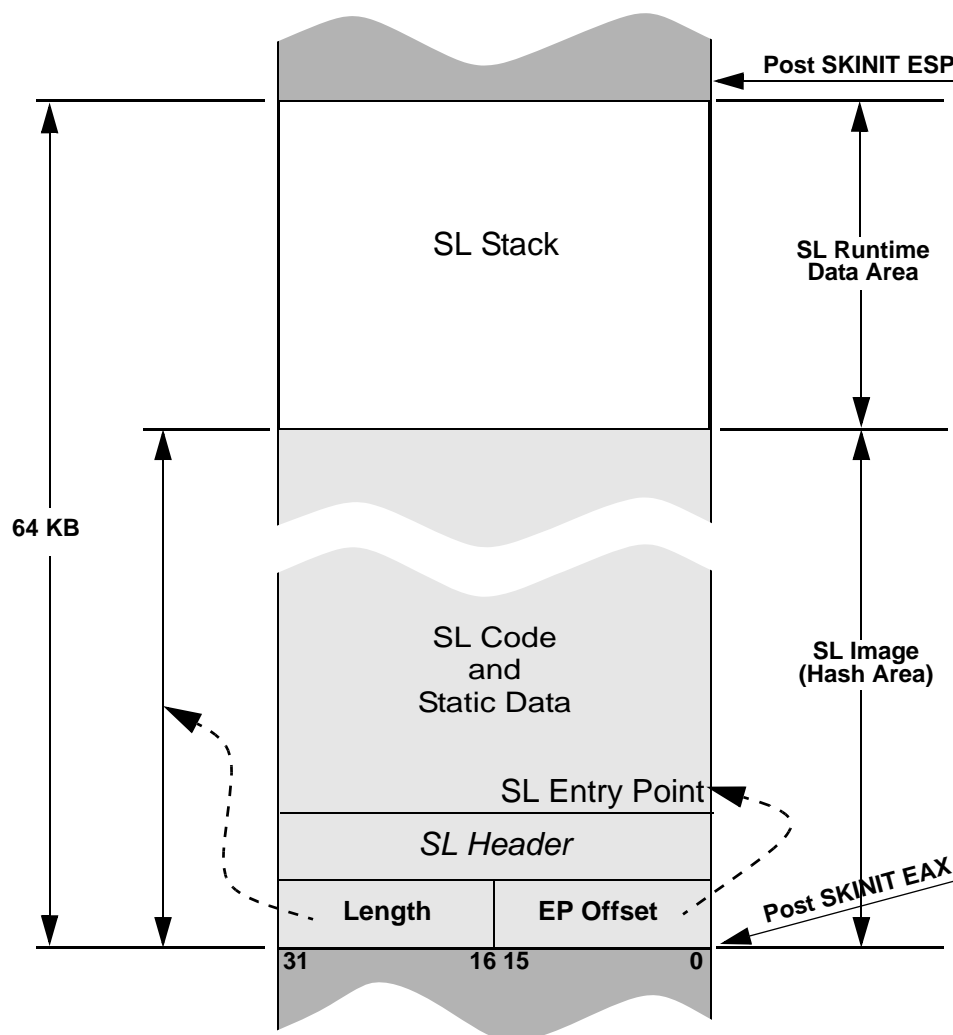

**Figure 15-14. SLB Example Layout**

#### 15.27.4 Trusted Platform Module

The trusted platform module, or TPM, is an essential part of full trusted system initialization. This device is attached to an LPC link off the system I/O hub. It recognizes special SKINIT transactions,

receives the SL image sent by SKINIT and verifies the signature. Based on the outcome, the device decides whether or not to cooperate with the SL or subsequent SK. The TPM typically contains sealed storage containing cryptographic keys and other high-security information that may be specific to the platform.

### 15.27.5 System Interface, Memory Controller and I/O Hub Logic

SKINIT uses special support logic in the processor's system interface unit, the internal controller and the I/O hub to which the TPM is attached. SKINIT uses special transactions that are unique to SKINIT, along with this support logic, designed to securely transmit the SL Image to the TPM for validation.

The use of this special protocol is intended to allow the TPM to detect true execution, as opposed to emulation, of a trusted Secure Loader, which in turn provides a means for verifying the subsequent loading and startup of a trusted Security Kernel.

### 15.27.6 SKINIT Operation

The SKINIT instruction is intended to be used primarily in normal mode prior to the VMM taking control.

SKINIT takes the physical base address of the SLB as its only input operand in EAX, and performs the following steps:

1. Reinitialize processor state in the same manner as for the INIT signal, then enter flat 32-bit protected mode with paging off. The CS selector is set to 8h and CS is read only. The SS selector is set to 10h and SS is read/write and expand-up. The CS and SS bases are cleared to 0 and limits are set to 4G. DS, ES, FS and GS are left as 16-bit real mode segments and the SL must reload these with protected mode selectors having appropriate GDT entries before using them. Initialized data in the SLB may be referenced using the SS segment override prefix until DS is reloaded. The general purpose registers are cleared except for EAX, which points to the start of the secure loader, EDX, which contains model, family and stepping information, and ESP, which contains the initial stack pointer for the secure loader. Cache contents remain intact, as do the x87 and SSE control registers. Most MSRs also retain their values, except those which might compromise SVM protections. The EFER MSR, however, is cleared. The DPD, R\_INIT and DIS\_A20M flags in the VM\_CR register are unconditionally set to 1.
2. Form the SLB base address by clearing bits 15:0 of EAX (EAX is updated), and enable the SL\_DEV protection mechanism (see "Secure Initialization Support" on page 490) to protect the 64-Kbyte region of physical memory starting at the SLB base address from any device access.
3. In multiprocessor operation, perform an interprocessor handshake as described in Section 15.27.8 on page 502.
4. Read the SL image from memory and transmit it to the TPM in a manner that cannot be emulated by software.
5. Signal the TPM to complete the hash and verify the signature. If any failures have occurred along the way, the TPM will conclude that no valid SL was started.

6. Clear the Global Interrupt Flag. This disables all interrupts, including NMI, SMI and INIT and ensures that the subsequent code can execute atomically. If the processor enters the shutdown state (due to a triple fault for instance) while GIF is clear, it can only be restarted by means of a RESET.
7. Update the ESP register to point to the first byte beyond the end of the SLB (SLB base + 65536), so that the first item pushed onto the stack by the SL will be at the top of the SLB.
8. Add the unsigned 16-bit entry point offset value from the SLB to the SLB base address to form the SL entry point address, and jump to it.

The validation of the SL image by the TPM is a one-way transaction as far as SKINIT is concerned. It does not depend on any response from the TPM after transferring the SL image before jumping to the SL entry point, and initiates execution of the Secure Loader unconditionally. Because of the processor initialization performed, SKINIT does not honor instruction or data breakpoint traps, or trace traps due to EFLAGS.TF.

**Pending interrupts.** Device interrupts that may be pending prior to SKINIT execution due to EFLAGS.IF being clear, or that assert during the execution of SKINIT, will be held pending until software subsequently sets GIF to 1. Similarly, SMI, INIT and NMI interrupts that assert after the start of SKINIT execution will also be held pending until GIF is set to 1.

**Debug Considerations.** SKINIT automatically disables various implementation-specific hardware debug features. A debug version of the SL can reenable those features by clearing the VM\_CR.DPD flag immediately upon entry.

### 15.27.7 SL Abort

If the SL determines that it cannot properly initialize a valid SK, it must cause GIF to be set to 1 and clear the VM\_CR MSR to re-enable normal processor operation.

### 15.27.8 Secure Multiprocessor Initialization

The following standard APIC features are used for secure MP initialization:

- The concept of a single Bootstrap Processor (BSP) and multiple Application Processors (APs).
- The INIT interprocessor interrupt (IPI), which puts the target processors into a halted state (INIT state) which is responsive only to a subsequent Startup IPI.
- The Startup IPI causes target processors to begin execution at a location in memory that is specified by the Boot Processor and conveyed along with the Startup IPI. The operation of the processor in response to a Startup IPI is slightly modified to support secure initialization, as described below.

A Startup IPI normally causes an AP to start execution at a location provided by the IPI. To support secure MP startup, each AP responds to a startup IPI by additionally clearing its GIF and setting the DPD, R\_INIT and DIS\_A20M flags in the VM\_CR register if, and only if, the BSP has indicated that it has executed an SKINIT. All other aspects of Startup IPI behavior remain unchanged.

**Software Requirements for Secure MP initialization.** The driver that starts the SL must execute on the BSP. Prior to executing the SKINIT instruction, the driver must save any processor-specific system register contents to memory for restoration after reinitialization of the APs. The driver should also put all APs in an idle state. The driver must first confirmed that all APs are idle and then it must issue an INIT IPI to all APs and wait for its local APIC busy indication to clear. This places the APs into a halted state which is responsive only to a subsequent Startup IPI. APs will still respond to snoops for cache coherency. The driver may execute SKINIT at any time after this point. Depending on processor implementation, a fixed delay of no more than 1000 processor cycles may be necessary before executing SKINIT to ensure reliable sensing of APIC INIT state by the SKINIT.

**AP Startup Sequence.** While the SL starts executing on the BSP, the APs remain halted in APIC INIT state. Either the SL or the SK may issue the Startup IPI for the APs at whatever point is deemed appropriate. The Startup IPI conveys an 8-bit vector specified by the software that issues the IPI to the APs. This vector provides the upper 8 bits of a 20-bit physical address. Therefore, the AP startup code must reside in the lower 1Mbyte of physical memory—with the entry point at offset 0 on that particular page.

In response to the Startup IPI, the APs start executing at the specified location in 16-bit real mode. This AP startup code must set up protections on each processor as determined by the SL or SK. It must also set GIF to re-enable interrupts, and restore the pre-SKINIT system context (as directed by the SL or SK executing on the BSP), before resuming normal system operation.

The SL must guarantee the integrity of the AP startup sequence, for example by including the startup code in the hashed SL image and setting up DEV protection for it before copying it to the desired area. The AP startup code does not need to (and should not) execute SKINIT.

**Pending interrupts.** Device interrupts that may be pending on an AP prior to the APIC INIT IPI due to EFLAGS.IF being clear, or that assert any time after the processor has accepted the INIT IPI, will be held pending through the subsequent Startup IPI, and remain pending until software sets GIF to 1 on that AP. Similarly, SMI, INIT, and NMI interrupts that assert after the processor has accepted the INIT IPI will also be held pending until GIF is set to 1.

**Aborting MP initialization.** In the event that the SL or SK on the BSP decides to abort SVM system initialization for any reason, the following clean-up actions must be performed by SL code executing on each processor before returning control to the original operating environment:

- The BSP and all APs that responded to the Startup IPI must restore GIF and clear VM\_CR on each processor for normal operation.
- For each processor that has a distinct memory controller associated with it, the SL\_DEV\_EN flag in the DEV control register must be cleared in order to restore normal device accessibility to the 64KB SL memory range.

Any secure context created by the SL that should not be exposed to untrusted code should be cleaned up as appropriate before these steps are taken.



## 15.28 Security Exception (#SX)

The Security Exception fault signals security-sensitive events that occur while executing the VMM, in the form of an exception so that the VMM may take appropriate action. (A VMM would typically intercept comparable sensitive events in the guest.) In the current implementation, the only use of the #SX is to redirect external INITs into an exception so that the VMM may — among other possibilities — destroy sensitive information before re-issuing the INIT, this time without redirection. The INIT redirection is controlled by the VM\_CR.R\_INIT bit.

The #SX exception dispatches to vector 30, and behaves like other fault-class exceptions such as General Protection Fault (#GP). The #SX exception pushes an error code. The only error code currently defined is 1, and indicates redirection of INIT has occurred.

The #SX exception is a contributory fault.

## 15.29 Advanced Virtual Interrupt Controller

The AMD Advanced Virtual Interrupt Controller (AVIC) is an important enhancement to AMD Virtualization™ Technology (AMD-V). In a virtualized environment, AVIC presents to each guest a virtual interrupt controller that is compliant with the local Advanced Programmable Interrupt Controller (APIC) architecture. See Chapter 16, “Advanced Programmable Interrupt Controller (APIC),” on page 531 for a detailed description of APIC.

### 15.29.1 Introduction

In a virtualized computer system, each guest operating system needs access to an interrupt controller to send and receive device and interprocessor interrupts. When there is no hardware acceleration, it falls to the virtual machine monitor (VMM) to intercept guest-initiated attempts to access the interrupt controller registers and provide direct emulation of the controller system programming interface allowing the guest to initiate and process interrupts. The VMM uses the underlying physical and virtual interrupt delivery mechanisms of the system to deliver interrupts from I/O devices and virtual processors to the target guest virtual processor and to handle any required end of interrupt processing.

Given the high rate of device and interprocessor interrupt generation in modern computer systems, the emulation of a local APIC is a significant burden for the VMM.

AVIC architecture addresses the overhead of guest interrupt processing in a virtualized environment by applying hardware acceleration to the following components of interrupt processing:

- Providing a guest operating system access to performance-critical interrupt controller registers
- Initiating intra- and inter-processor interrupts (IPIs) in and between virtual processors in a guest

Acceleration of the delivery of virtual interrupts from I/O devices to virtual processors is not addressed directly by AVIC hardware. This acceleration would be provided by an I/O memory management unit (IOMMU). The AVIC architecture is compatible with the AMD I/O Memory Management Unit

(IOMMU). For more information on the IOMMU architecture, see *AMD I/O Virtualization Technology (IOMMU) Specification* (order #48882).

### 15.29.1.1 Local APIC Register Access

The system programming interface for the local APIC comprises a set of memory-mapped registers. In a non-virtualized environment, system software directly reads and writes these registers to configure the interrupt controller and initiate and process interrupts. In a virtualized environment, each guest operating system still requires access to this system programming interface but does not own the underlying interrupt processing hardware. To provide this facility to the guest operating system, VMM-level software emulates the local APIC for each guest virtual processor.

The AVIC architecture provides an image of the local APIC called the guest virtual APIC (guest vAPIC) in the guest physical address (GPA) space of each virtual processor when the virtual machine for the guest is instantiated. This image is backed by a page in the system physical address (SPA) space called a vAPIC backing page. The backing page remains pinned in system memory as long as the virtual machine persists, even when the specific virtual processor associated with the backing page is not running. Accesses to the memory-mapped register set by the guest are redirected by AVIC hardware to this backing page.

The VMM reads configuration, control, and command information written by the guest from the backing page and writes status information to this page for the guest to read. The guest is allowed to read most registers directly without the need for VMM intervention. Most writes are intercepted allowing the VMM to process and act on the configuration, control, and command data from the guest. However, for certain frequently used command and control operations, specific hardware support allows the guest to directly initiate interrupts and complete end of interrupt processing eliminating the need for VMM intervention in the execution of performance-critical operations.

**Software-initiated Interrupts.** Modern operating systems use software interrupts (self-IPIs) to implement software event signalling, inter-process communication and the scheduling of deferred processing. System software sets up and initiates these interrupts by writing to control registers of the local APIC. AVIC hardware reduces VMM overhead by providing hardware assist for many of these operations.

**Inter-processor Interrupts.** Inter-processor interrupts (IPIs) are used extensively by modern operating systems to handle communication between processor cores within a machine (or, in a virtualized environment, between virtual processors within a virtual machine). IPIs are also employed to provide signaling and synchronization for operations such as cross-processor TLB invalidations (also known as TLB shootdowns). AVIC provides hardware mechanisms that deliver the interrupt to the virtual interrupt controller of the target virtual processor without VMM intervention.

### 15.29.2 Architectural Definition

The following sections describe the AVIC architecture. Specific implementations of AVIC may deviate from this description as long as the observed behavior of the hardware complies with this description.

### 15.29.2.1 Virtualizing the Local APIC

The guest virtual processor accesses the facilities of its local APIC by reading and writing a set of registers located in a 4-Kbyte page in its guest physical address space. AVIC hardware virtualizes this access by redirecting attempted accesses by the guest to a vAPIC backing page located in system physical address (SPA) space.

AVIC hardware detects attempted accesses by the guest to its local APIC register set and redirects these accesses to the vAPIC backing page. This is illustrated in the figure below.

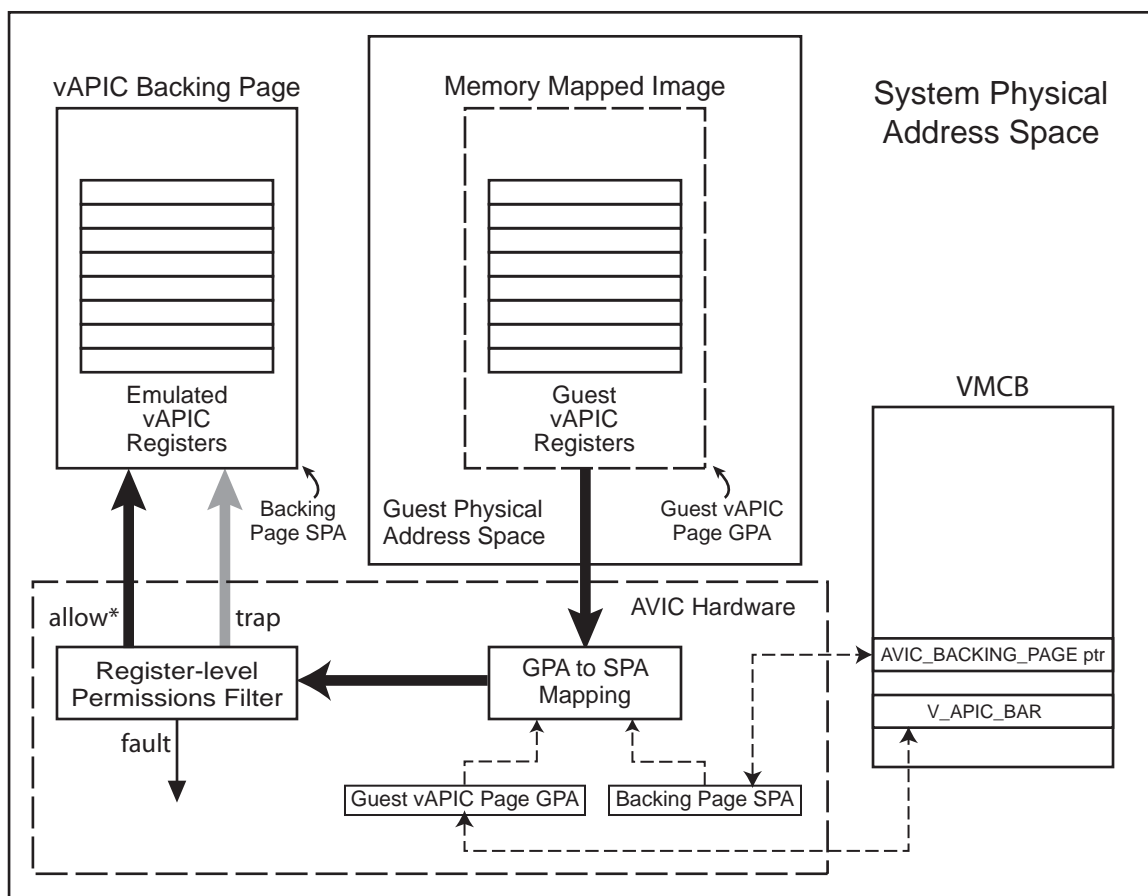

\*Writes to specific registers can initiate AVIC hardware actions

v2\_AVIC\_diagram2.eps

**Figure 15-15. vAPIC Backing Page Access**

To correctly redirect guest accesses of the guest vAPIC registers to the vAPIC backing page, the hardware needs two addresses. These are:

- vAPIC backing page address in the SPA space
- Guest vAPIC base address (APIC BAR) in the GPA space

System software is responsible for setting up a translation in the nested page table granting guest read and write permissions for accesses to the vAPIC Backing Page in SPA space. AVIC hardware walks the nested page table to check permissions, but does not use the SPA address specified in the leaf page table entry. Instead, AVIC hardware finds this address in the AVIC\_BACKING\_PAGE pointer field of the VMCB.

The VMM initializes the backing page with appropriate default APIC register values including items such as APIC version number. The vAPIC backing page address and the guest vAPIC base address are stored in the VMCB fields AVIC\_BACKING\_PAGE pointer and V\_APIC\_BAR respectively.

System firmware initializes the value of guest vAPIC base address (and VMCB.V\_APIC\_BAR) to FEE0\_0000h. This is the address where the guest operating system expects to find the local APIC register set when it boots. If the guest attempts to relocate the local APIC register base address in GPA space by writing to the APIC Base Address Register (MSR 0000\_001Bh), the VMM should intercept the write to update the V\_APIC\_BAR field of the guest's VMCB(s) and the GPA part of translation in the virtual machine's nested page tables.

The vAPIC backing page must be present in system physical memory for the life of the guest VM because some fields are updated even when the guest is not running.

**Virtual APIC Register Accesses.** AVIC hardware detects attempted guest accesses to the vAPIC registers in the backing page. These attempted accesses are handled by the register-level permissions filter in one of three ways:

- Allow—The access to the backing page is allowed to complete. Writes update the backing page value, while reads return the current value. In certain cases, a write results in specific hardware-based acceleration actions (summarized in Table 15-21 and described below).
- Fault—The processor performs an SVM intercept before the access. Causes a #VMEXIT.
- Trap—The processor performs an SVM intercept immediately after the access completes. Causes a #VMEXIT.

The details of this behavior for each of these registers are summarized in the following table:

**Table 15-21. Guest vAPIC Register Access Behavior**

Offset	Register Name	Result
20h	APIC ID Register	Read: Allowed Write: #VMEXIT (trap)
30h	APIC Version Register	Read: Allowed Write: #VMEXIT (fault)
80h	Task Priority Register (TPR)	Read: Allowed Write: Accelerated by AVIC
90h	Arbitration Priority Register (APR)	Read: #VMEXIT (fault) Write: #VMEXIT (fault)
A0h	Processor Priority Register (PPR)	Read: Allowed Write: #VMEXIT (fault)

**Table 15-21. Guest vAPIC Register Access Behavior (continued)**

Offset	Register Name	Result
B0h	End of Interrupt Register (EOI)	Read: Allowed Write: Accelerated by AVIC for edge-triggered interrupts or #VMEXIT (trap) for level triggered interrupts
C0h	Remote Read Register	Read: Allowed Write: #VMEXIT (trap)
D0h	Logical Destination Register	Read: Allowed Write: #VMEXIT (trap)
E0h	Destination Format Register	Read: Allowed Write: #VMEXIT (trap)
F0h	Spurious Interrupt Vector Register	Read: Allowed Write: #VMEXIT (trap)
100h–170h	In-Service Register (ISR)	Read: Allowed Write: #VMEXIT (fault)
180h–1F0h	Trigger Mode Register (TMR)	Read: Allowed Write: #VMEXIT (fault)
200h–270h	Interrupt Request Register (IRR)	Read: Allowed Write: #VMEXIT (fault)
280h	Error Status Register (ESR)	Read: Allowed Write: #VMEXIT (trap)
300h	Interrupt Command Register Low (bits 31:0)	Read: Allowed Write: Accelerated by AVIC or #VMEXIT (trap) for advanced functions.
310h	Interrupt Command Register High (bits 63:32)	Read: Allowed Write: Allowed
320h	Timer Local Vector Table Entry	Read: Allowed Write: #VMEXIT (trap)
330h	Thermal Local Vector Table Entry	Read: Allowed Write: #VMEXIT (trap)
340h	Performance Counter Local Vector Table Entry	Read: Allowed Write: #VMEXIT (trap)
350h	Local Interrupt 0 Vector Table Entry	Read: Allowed Write: #VMEXIT (trap)
360h	Local Interrupt 1 Vector Table Entry	Read: Allowed Write: #VMEXIT (trap)
370h	Error Vector Table Entry	Read: Allowed Write: #VMEXIT (trap)
380h	Timer Initial Count Register	Read: Allowed Write: #VMEXIT (trap)

**Table 15-21. Guest vAPIC Register Access Behavior (continued)**

Offset	Register Name	Result
390h	Timer Current Count Register	Read: #VMEXIT (fault) Write: #VMEXIT (fault)
3E0h	Timer Divide Configuration Register	Read: Allowed Write: #VMEXIT (trap)
400h– FFFh	Extended Registers	Read: #VMEXIT (fault) Write: #VMEXIT (fault)

Accesses to any other register locations not explicitly defined in this table are allowed to read and write the backing page.

All vAPIC registers are 32-bits wide and are located at 16-byte aligned offsets. The results of an attempted read or write of any bytes in the range [register\_offset + 4:register\_offset + 15] are undefined.

Guest writes to the Task Priority Register (TPR) and specific usage cases of writes to the End of Interrupt (EOI) Register and the Interrupt Command Register Low (ICRL) cause specific hardware actions. AVIC hardware allows guest writes to the Interrupt Command Register High (ICRH) since the writing of this register has no immediate hardware side-effect. AVIC hardware maintains and uses the value in the Processor Priority Register (PPR) to control the delivery of interrupts to guest virtual processors. The following sections discuss the handling of accesses by the guest to these registers in the vAPIC backing page.

**Task Priority Register (TPR).** When the guest operating system writes to the TPR, the value is updated in the backing page and the upper 4 bits of the value are automatically copied by the hardware to the V\_TPR value in the VMCB. All reads from the TPR location return the value from the vAPIC backing page. Also, any TPR accesses using the MOV CR8 semantics update the backing page and V\_TPR values.

The priority value stored in CR8 and V\_TPR are not the same format as the APIC TPR register. Only the Task Priority bits of are maintained in the lower 4 bits of CR8 and V\_TPR. The Task Priority Sub-class value is not stored. Writes to the memory-mapped TPR register update bits 0:3 of CR8 and V\_TPR and writes to CR8 update the TPR backing page value bits 7:4 while bits 3:0 are set to zero.

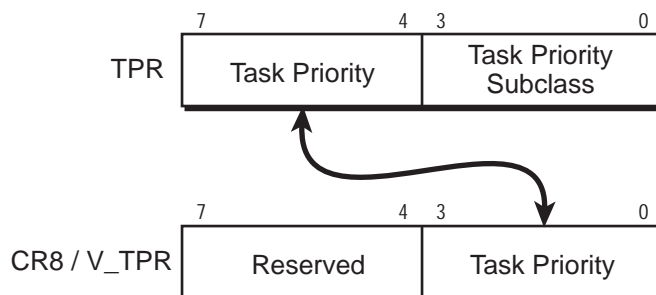

v2\_TPR\_figure.eps

**Figure 15-16. Virtual APIC Task Priority Register Synchronization**

The synchronization between the Task Priority field of the TPR and the Task Priority field of CR8 is normal local APIC behavior which is emulated by AVIC. For more information on the APIC, see Chapter 16, “Advanced Programmable Interrupt Controller (APIC),” on page 531.

**Processor Priority Register (PPR).** Writes to the processor priority register by the guest cause a #VMEXIT without updating the value in the backing page. AVIC hardware maintains the PPR value in the backing page. AVIC hardware updates the PPR value in the backing page when either the TPR value or the highest in-service interrupt changes. This value is used to control the delivery of virtual interrupts to the guest. PPR reads by the guest are allowed.

**End of Interrupt (EOI) Register.** When the guest writes to the EOI register address, AVIC hardware clears the highest priority in-service interrupt (ISR) bit in the backing page and re-evaluates the interrupt state to determine if another pending interrupt should be delivered. If the highest priority in-service interrupt is set to level mode (in the corresponding TMR bit), the EOI write causes a #VMEXIT to allow the VMM to emulate the level-triggered behavior.

**Interrupt Control Register Low (ICRL).** Writes to the ICRL register have the side-effect of initiating the generation of an interprocessor interrupt (IPI) based on the values written to the fields in both the ICRL and ICRH registers. AVIC hardware handles the generation of IPIs when the specified Message Type is Fixed (also known as fixed delivery mode) and the Trigger Mode is edge-triggered. The hardware also supports self and broadcast delivery modes specified via the Destination Shorthand (DSH) field of the ICRL. Logical and physical APIC ID formats are supported. All other IPI types cause a #VMEXIT. For more information on AVIC’s handling of IPI commands, see “Inter-processor Interrupts” on page 505.

### 15.29.2.2 VMCB Changes in Support of AVIC

The following paragraphs provide an overview of new VMCB fields defined as part of the AVIC architecture.

**VMCB Control Word.** AVIC adds the AVIC Enable bit to the VMCB control word at offset 60h:

**Table 15-22. Virtual Interrupt Control (VMCB offset 60h)**

VMCB offset	Bit(s)	Field Name	Description
060h	7:0	V_TPR	Virtual TPR for the guest <sup>1 2</sup>
	8	V_IRQ	If nonzero; virtual INTR is pending <sup>2 3</sup>
	15:9	—	Reserved, SBZ
	19:16	V_INTR_PRIO	Priority for virtual interrupt <sup>3</sup>
	20	V_IGN_TPR	If nonzero, the current virtual interrupt ignores the virtual TPR <sup>3</sup>
	23:21	—	Reserved, SBZ
	24	V_INTR_MASKING	Virtualized masking of INTR interrupts
	:25	—	Reserved, SBZ
	31	AVIC Enable	If set, enables AVIC
	39:32	V_INTR_VECTOR	Vector to use for this interrupt <sup>3</sup>
63:40	—	Reserved, SBZ	

**Note(s):**

1. Bits 3:0 are used for the 4-bit virtual TPR value; bits 7:4 are Reserved, SBZ.
2. This value is written back to the VMCB at #VMEXIT.
3. This field is ignored on VMRUN when AVIC is enabled.

**AVIC Enable—Virtual Interrupt Control, Bit 31.** The AVIC hardware support may be enabled on a per virtual processor basis. This bit determines whether or not AVIC is enabled for a particular virtual processor. Any guest configured to use AVIC must also enable RVI (nested paging). Enabling AVIC implicitly disables the V\_IRQ, V\_INTR\_PRIO, V\_IGN\_TPR, and V\_INTR\_VECTOR fields in the VMCB Control Word.

**Newly Defined VMCB Fields.** AVIC utilizes a number of formerly reserved locations in the VMCB. Table 15-23 below lists the new fields defined by the architecture:

**Table 15-23. New VMCB Fields Defined by AVIC**

VMCB Offset	Bit(s)	Field Name	Description
098h	63:52	Reserved, SBZ	—
	51:12	V_APIC_BAR	Bits 51:12 of the GPA of the guest vAPIC register bank
	11:0	Reserved, SBZ	—
0E0h	63:52	Reserved, SBZ	—
	51:12	AVIC_BACKING_PAGE Pointer	Bits 51:12 of HPA of the vAPIC backing page
	11:0	Reserved, SBZ	—



Table 15-23. New VMCB Fields Defined by AVIC

VMCB Offset	Bit(s)	Field Name	Description
0F0h	63:52	Reserved, SBZ	—
	51:12	AVIC_LOGICAL_TABLE Pointer	Bits 51:12 of HPA of the Logical APIC Table
	11:0	Reserved, SBZ	—
0F8h	63:52	Reserved, SBZ	—
	51:12	AVIC_PHYSICAL_TABLE Pointer	Bits 51:12 of HPA for the Physical APIC Table
	11:8	Reserved, SBZ	—
	7:0	AVIC_PHYSICAL_MAX_INDEX	Index of the last guest physical core ID for this guest

These fields are discussed further in the following paragraphs:

**V\_APIC\_BAR—VMCB, Offset 098h.** This entry is used to hold a copy of guest physical base address of its local APIC register block. The guest can change the GPA of its local APIC register block by writing to the guest version of the APIC Base Address Register (MSR 0000\_001Bh). Writes to this MSR are intercepted by the VMM and the value is used to update the GPA in the nested page table entry for the vAPIC backing page and the value to be saved in this field of the VMCB.

**APIC\_BACKING\_Page Pointer—VMCB, Offset 0E0h.** This is a 52-bit HPA pointer to the vAPIC backing page for this virtual processor. The vAPIC backing page is described in more detail in the following section.

**Logical APIC Table Pointer—VMCB, Offset 0F0h.** This is a 52-bit HPA pointer to the Logical APIC ID Table for the virtual machine containing this virtual processor. This table is described in more detail in the following section.

**Physical APIC Table Pointer—VMCB, Offset 0F8h.** This is a 52-bit HPA pointer to the Physical APIC ID Table for the virtual machine containing this virtual processor. This table is described in more detail in the following section.

**AVIC\_PHYSICAL\_MAX\_INDEX—VMCB, Offset 0F8h.** Bits [7:0]. This 8-bit value provides the index of the last guest physical core ID for this guest.

**Restrictions on Physical Address Pointers.** All of the physical addresses in the previous sections must point to legal, implementation-supported physical address ranges. These pointers are evaluated on VMRUN and cause a #VMEXIT if they are outside of the legal range. These memory ranges must be mapped as write-back cacheable memory type.

All the addresses point to 4-Kbyte aligned data structures. Bits 11:0 are reserved (except for offset 0F8h) and should be set to zero. The lower 8 bits of offset 0F8h are used for the field AVIC\_PHYSICAL\_MAX\_INDEX.

### 15.29.2.3 AVIC Memory Data Structures

The AVIC architecture defines three new memory-resident data structures. Each of these structures is defined to fit exactly in one 4-Kbyte page. Future implementations may expand the size.

**Virtual APIC Backing Page.** Each virtual processor in the system is assigned a virtual APIC backing page (vAPIC backing page). Accesses by the guest to the local APIC register block in the guest physical address space are redirected to the vAPIC backing page in system memory. The vAPIC backing page is used by AVIC hardware and the VMM to emulate the local APIC. See “Virtual APIC Register Accesses” on page 507 for a detailed description.

**Physical APIC ID Table.** The physical APIC ID table is set up and maintained by the VMM and is used by the hardware to locate the proper vAPIC backing page to be used to deliver interrupts based on the guest physical APIC ID. One physical APIC ID table must be provided per virtual machine.

The guest physical APIC ID is used as an index into this table. Each entry contains a pointer to the virtual processor’s vAPIC backing page, a bit to indicate whether the virtual processor is currently scheduled on a physical core, and if so, the physical APIC ID of that core.

The length of this table is fixed at 4 Kbytes allowing a maximum of 512 virtual processors per virtual machine. However, in this version of the architecture the maximum number of virtual processors per guest is limited to 256. The physical ID table can be populated in a sparse manner using the valid bit to indicate assigned IDs. The index of the last valid entry is stored in the VMCB AVIC\_PHYSICAL\_MAX\_INDEX field.

A pointer to this table is maintained in the VMCB. Because there is a single Physical APIC ID Table per virtual machine, the value of this pointer is the same for every virtual processor within the virtual machine.

Each entry in the table has the following format:



The Physical APIC ID Table occupies the lower half of a single 4-Kbyte memory page, formatted as follows:

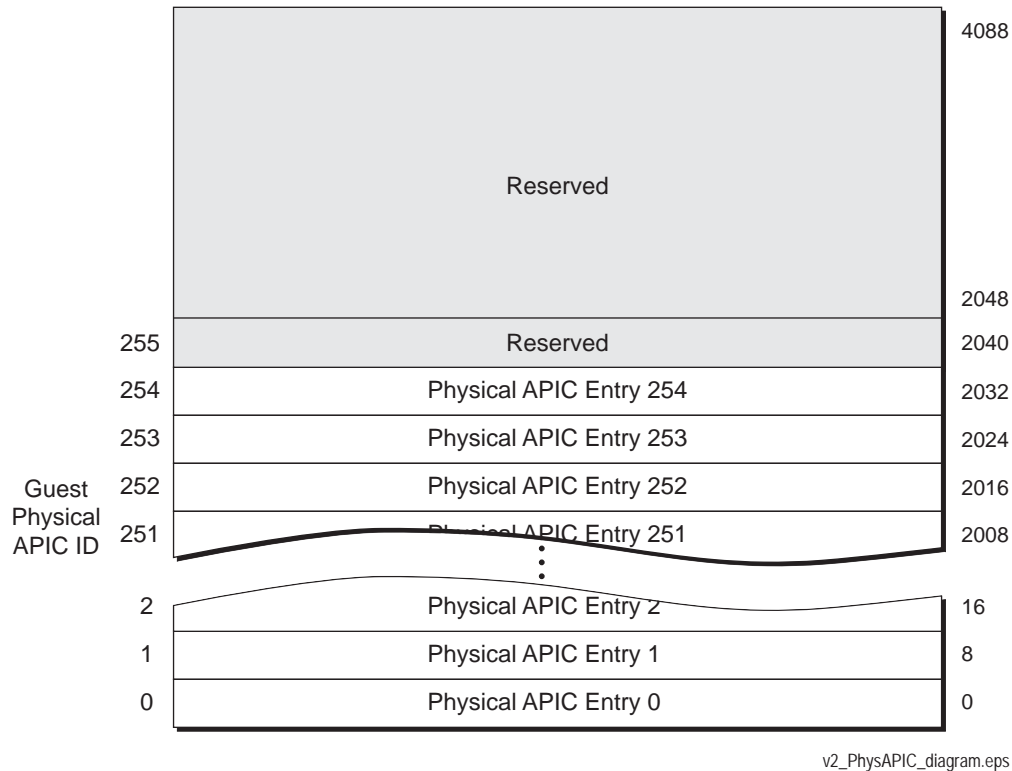

**Figure 15-18. Physical APIC Table in Memory.**

Since a destination of FFh is used to specify a broadcast, physical APIC ID FFh is reserved. The upper 2048 bytes of the table are reserved and should be set to zero.

**Logical APIC ID Table.** In addition to the Physical APIC ID Table, each guest VM is assigned a Logical APIC ID Table. This table is used to lookup the guest physical APIC ID for logically addressed interrupt requests. Each entry of this table provides the guest physical APIC ID corresponding to a single logically addressed APIC. Note that this implies that the logical ID of each vAPIC must be unique. The entries of this table are selected using the logical ID and interpreted differently depending upon logical APIC addressing mode of the guest. logical destination modes are supported: flat clustered.

If the guest attempts to change the logical ID of its APIC, the VMM must reflect this change in the Logical APIC ID Table. AVIC hardware supports the fixed interrupt message type targeting one or more logical destinations. The hardware also supports self and broadcast delivery modes specified via the Destination Shorthand (DSH) field of the ICRL. Any other message types must be supported through emulation by the VMM.

A pointer to this table is maintained in the VMCB. Because there is a single Logical APIC ID Table per virtual machine, the value of this pointer is the same for every virtual processor within the virtual machine.

For all logical destination modes, the table entries have the following format:

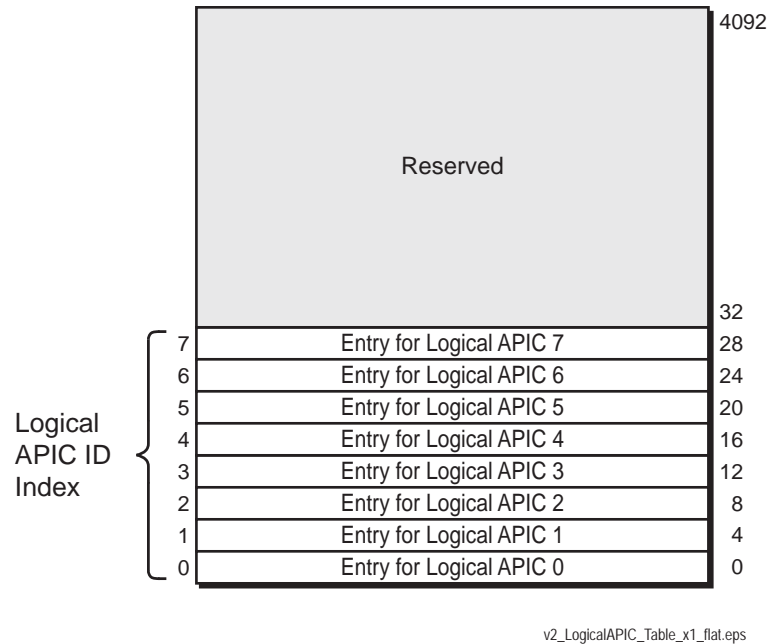

**Figure 15-19. Logical APIC ID Table Entry**

**Table 15-25. Logical APIC ID Table Entry Fields**

Bit(s)	Field Name	Description
31	V	Valid Bit. When set, indicates that this table entry contains a valid physical APIC ID. If cleared, this table entry contains no information.
30:8	—	Reserved, SBZ. Should always be set to zero.
7:0	Guest Physical APIC ID	Guest physical APIC ID corresponding to the local APIC selected when logically addressed.

**Logical APIC ID Table Format for Flat Mode.** When running in flat mode, AVIC expects the logical APIC ID table to be formatted as shown in Figure 15-20 below. This mode uses only the first 8 entries of the table. Although the logical APIC ID is an eight bit value, supported encodings must be of the form  $2^i$ , where  $i = 0$  to  $7$ . In the figure the value  $i$  is used and represents the index into the table. The actual byte offset into the table for a given logical APIC ID  $l\_apic\_id$  is  $4 * \log_2(l\_apic\_id)$ .



**Figure 15-20. Logical APIC ID Table Format, Flat Mode.**

**Logical APIC ID Table Format for Cluster Mode.** In cluster mode, bits [7:4] of the logical APIC ID represent the cluster number and bits [3:0] represent the APIC index (bit encoded). The cluster number Fh (15) is reserved. Since the APIC index field is four bits, four encodings are supported for the APIC index value.

The actual byte offset into the table for a given cluster *c* and an APIC index *apic\_ix* is  $(16 * c) + 4 * \log_2(\text{apic\_ix})$

When running in cluster mode, AVIC expects the logical APIC ID table to be formatted as shown in Figure 15-21 below.

Reserved	4092
	240
Entry for Cluster 14, Logical APIC 3	236
Entry for Cluster 14, Logical APIC 2	
Entry for Cluster 14, Logical APIC 1	
Entry for Cluster 14, Logical APIC 0	224
⋮	
Entry for Cluster 1, Logical APIC 3	28
Entry for Cluster 1, Logical APIC 2	24
Entry for Cluster 1, Logical APIC 1	20
Entry for Cluster 1, Logical APIC 0	16
Entry for Cluster 0, Logical APIC 3	12
Entry for Cluster 0, Logical APIC 2	8
Entry for Cluster 0, Logical APIC 1	4
Entry for Cluster 0, Logical APIC 0	0

v2\_LogicalAPIC\_Table\_x1\_cluster.eps

**Figure 15-21. Logical APIC ID Table Format, Cluster Mode.**

#### 15.29.2.4 Interrupt Delivery

There are two fundamental types of virtual interrupts—interprocessor interrupts (IPIs) and I/O device interrupts (device interrupts). An IPI is initiated when guest system software writes the ICRL register. A device interrupt is initiated by a I/O device that has been programmed by guest system software (usually a device driver) to send a message signalling an event to a specific guest physical processor. This message usually includes an interrupt vector number indicating the nature of the event.

The following sections discuss the actions taken by AVIC hardware when a virtual processor signals an IPI and the actions taken by I/O virtualization hardware when a device signals a virtual interrupt.

**Interprocessor Interrupts.** To process an IPI, AVIC hardware executes the following steps:

1. If the destination-shorthand coded in the command is 01b (i.e. self), update the IRR in the backing page, signal doorbell to self and skip remaining steps.
2. If destination-shorthand is non-zero, or if the destination field is FFh (i.e. broadcast), jump to step 4.
3. If the destination(s) is (are) logically addressed, lookup the guest physical APIC IDs for each logical ID using the Logical APIC ID table.

If the entry is not valid (V bit is cleared), cause a #VMEXIT.

If the entry is valid, but contains an invalid backing page pointer, cause a #VMEXIT.

4. Lookup the vAPIC backing page address in the Physical APIC table using the guest physical APIC ID as an index into the table.  
For directed interrupts, if the selected table entry is not valid, cause a #VMEXIT. For broadcast IPIs, invalid entries are ignored.
5. For every valid destination:
  - Atomically set the appropriate IRR bit in each of the destinations' vAPIC backing page.
  - Check the IsRunning status of each destination.
  - If the destination IsRunning bit is set, send a doorbell message using the host physical core number from the Physical APIC ID table.
6. If any destinations are identified as not currently scheduled on a physical core (i.e., the IsRunning bit for that virtual processor is not set), cause a #VMEXIT.

Refer to Section on page 521 for new exitcodes associated with the #VMEXIT exceptions listed above.

**Device Interrupts.** The delivery of a I/O device interrupt to a virtual processor is handled by an IOMMU with virtual interrupt capability. To deliver a virtual interrupt, I/O virtualization hardware executes the following steps:

1. An interrupt message arrives from the I/O device identifying the source device and interrupt vector number.
2. I/O virtualization hardware uses the device ID to determine the guest physical APIC ID of the core that is the target of the device interrupt.
3. I/O virtualization hardware uses the guest physical APID ID to index into the Physical APIC ID Table to find the SPA of the vAPIC backing page. If the I/O virtualization hardware accesses an entry in the Physical APIC ID Table that is not valid (V bit is cleared), the I/O virtualization hardware aborts the virtual interrupt delivery and logs an error.
4. I/O virtualization hardware performs any required vector number translation.
5. I/O virtualization hardware atomically sets the bit in the IRR in the vAPIC backing page that corresponds to the vector.
6. If the virtual processor that is the target of the interrupt is not currently running on its assigned physical core, the virtual interrupt will be presented when the virtual processor is made active again. I/O virtualization hardware may provide additional information to the VMM about the device interrupt to aid in virtual processor scheduling decisions.

If the virtual processor that is the target of the interrupt is scheduled on a physical processor (indicated by the IsRunning bit of the Physical APIC ID table entry being set), I/O virtualization hardware uses the host physical APIC ID in the table entry to send a doorbell signal to the corresponding processor core to signal that an interrupt needs to be processed.



### 15.29.2.5 CPUID Feature Bits

A CPUID feature bit is used to indicate support for AVIC on a specific hardware implementation. CPUID Fn8000\_000A\_EDX[AVIC] is designated for this purpose and is returned in bit 13 of EDX. If EDX[13] is set, the AVIC architecture is supported on that hardware.

See Section 3.3, “Processor Feature Identification,” on page 63 for more information on using the CPUID instruction.

### 15.29.2.6 New Processor Mechanisms

In order to support the direct injection of interrupts into the guest and to accelerate critical vAPIC functions, new hardware mechanisms are implemented in the processor.

**Special Trap/Fault Handling for vAPIC Accesses.** To virtualize the local APIC utilized by the guest to generate and process interrupts, all read and write accesses by the guest virtual processor to its local APIC registers are redirected to the vAPIC backing page. Most reads and many writes to this guest physical address range read or write the contents of memory locations within the vAPIC backing page at the corresponding offset.

To support proper handling and emulation of the guest local APIC, the processor provides permissions filtering hardware (Refer to Figure 15-15 on page 506.) that detects and intercepts accesses to specific offsets (representing APIC registers) within the vAPIC backing page. This hardware either allows the access, blocks the access and causes a #VMEXIT (fault behavior), or allows the access and then causes a #VMEXIT (trap behavior).

Hardware directly handles the side effects of guest writes to the TPR and EOI registers. Writes to the ICRL register with simple functional side effects such as the generation of a directed IPI or a self-IPI request are handled directly. Values written to the ICRL defined to initiate more complex behavior cause a #VMEXIT to allow the VMM to emulate the function. A guest write to the ICRH register has no immediate hardware side effect and is allowed.

Most other write access attempts within the vAPIC register bank address range cause a #VMEXIT with trap or fault behavior allowing the VMM to emulate the function of that register. See Table 15-21 on page 507 for more detail.

Reads and writes to locations within the vAPIC backing page, but outside the offset range of defined vAPIC registers are allowed to complete.

**Doorbell Mechanism.** Each core provides a doorbell mechanism that is used by other cores (for IPIs) and the IOMMU (for device interrupts) to signal to the VMM of the target physical core that a virtual interrupt requires processing. The exact mechanism is implementation-specific, but must be protected from access from non-privileged software running on other cores and from direct access by an external device.

When the doorbell is received in guest mode, hardware on the receiving core evaluates the vAPIC state in the vAPIC backing page for the currently running virtual processor and injects the interrupt into the guest as appropriate.

**Doorbell Register.** The system programming interface to the doorbell mechanism is provided via an MSR. Sending a doorbell signal to another core is initiated by writing the physical APIC ID corresponding to that core to the Doorbell Register (MSR C001\_011Bh). The format of this register is shown in Figure 15-22 below.

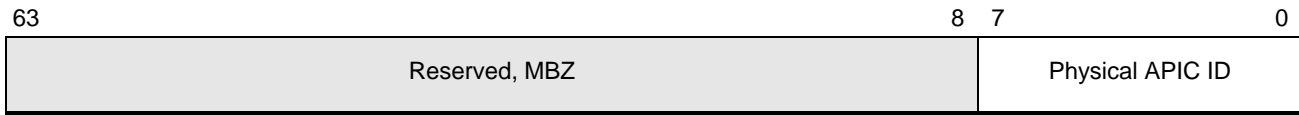

**Figure 15-22. Doorbell Register, MSR C001\_011Bh**

Writing to this register causes a doorbell signal to be sent to the specified physical core. Any attempt to read from this register results in a #GP.

**Processing of Doorbell Signals.** A doorbell signal delivered to a running guest is recognized by the hardware regardless of whether it can be immediately injected into the guest as a virtual interrupt. On the next VMRUN, the virtual interrupt delivery mechanism evaluates the state of the IRR register of the guest's vAPIC backing page to find the highest priority pending interrupt and injects it if interrupt masking and priority allow.

**Additional VMRUN Handling.** In addition to the normal VMRUN operations, the core re-evaluates the APIC state in the vAPIC backing page upon entry into the guest and processes pending interrupts as necessary. Specifically:

- On VMRUN the interrupt state is evaluated and the highest priority pending interrupt indicated in the IRR is delivered if interrupt masking and priority allow
- Any doorbell signals received during VMRUN processing are recognized immediately after entering the guest
- When AVIC mode is enabled for a virtual processor, the V\_IRQ, V\_INTR\_PRIO, V\_INTR\_VECTOR, and V\_IGN\_TPR fields in the VMCB are ignored.

### 15.29.2.7 New Exit Codes for AVIC

The AVIC architecture defines two new AVIC-related #VMEXIT events. These cases are described in the following sections. Assigned EXITCODE values are given in Table C-1 on page 587.

**AVIC IPI Delivery Not Completed.** An IPI could not be delivered to all targeted guest virtual processors because at least one guest virtual processor was not allocated to a physical core at the time. This results in a #VMEXIT with an exit code of AVIC\_INCOMPLETE\_IPI. Additional data associated with this #VMEXIT event is returned in the EXITINFO1 and EXITINFO2 fields.

**EXITINFO1.** This field contains the values written to the vAPIC ICRH and ICRL registers.

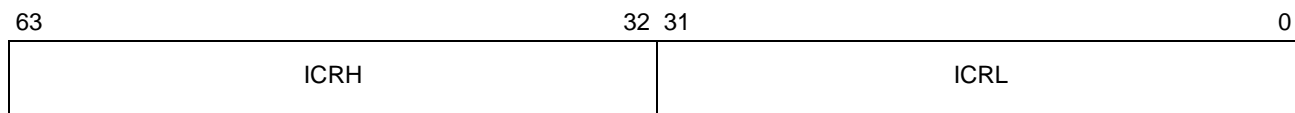

Figure 15-23. EXITINFO1

Table 15-26. EXTINFO1 Fields

Bit(s)	Field Name	Description
63:32	ICRH	Value written to the vAPIC ICRH register.
31:0	ICRL	Value written to the vAPIC ICRL register.

**EXITINFO2.** This field contains information describing the specific reason for the IPI delivery failure.

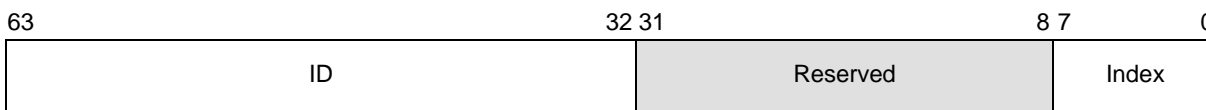

Figure 15-24. EXITINFO2

Table 15-27. EXTINFO2 Fields

Bit(s)	Field Name	Description
63:32	ID	Specific reason for the delivery failure. See Table 15-28 for defined values.
31:8	—	Reserved
7:0	Index	For ID = 1 – 3, this field provides the index of a logical or physical table entry. Reserved for all other ID values.

The ID field identifies the reason for the IPI delivery failure:

**Table 15-28. ID Field—IPI Delivery Failure Cause**

ID	Cause	Description	Index
0	Invalid Interrupt type	The trigger mode for the specified IPI was set to level or the destination type is unsupported.	Reserved.
1	IPI Target Not Running	IsRunning bit of the target for a Singlecast/Broadcast/Multicast IPI is not set in the physical APIC ID table.	Index of the physical or logical APIC ID table entry for the target virtual processor that was not scheduled on a physical core.
2	Invalid Target in IPI	Target ID invalid. This is due to one the following reasons: <ul style="list-style-type: none"> <li>In logical mode: cluster &gt; max_cluster (64)</li> <li>In physical mode: target &gt; max_physical (512)</li> <li>address is not present in the physical or logical ID tables</li> </ul>	Index of the physical or logical table entry for the invalid target.
3	Invalid Backing Page Pointer	The vAPIC Backing Page Pointer field of the Physical APIC ID Table contained an invalid physical address.	For shorthand or broadcast delivery modes, index of the physical APIC ID Table containing the invalid address. For directed IPIs, index of the logical or physical APIC ID table depending on the destination mode.
> 3	Reserved	—	Reserved

**AVIC Access to un-accelerated vAPIC register.** A guest access to an APIC register that is not accelerated by AVIC results in a #VMEXIT with the exit code of AVIC\_NOACCEL. This fault is also generated if an EOI is attempted when the highest priority in-service interrupt is set for level-triggered mode. Additional data associated with this #VMEXIT event is returned in the EXITINFO1 and EXITINFO2 fields.

**EXITINFO1.** This field contains the offset of the un-accelerated virtual APIC register and a bit indicating whether a read or write operation was attempted.

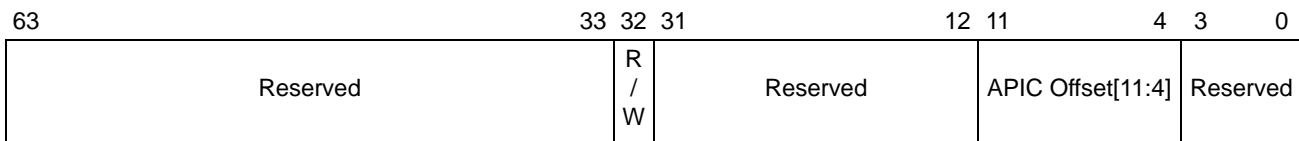

**Table 15-29. EXTINFO1 Fields**

Bit(s)	Field Name	Description
63:33	—	Reserved.
32	R/W	If set, write was attempted. If clear, read was attempted.

Table 15-29. EXTINFO1 Fields

Bit(s)	Field Name	Description
31:12	—	Reserved.
11:4	APIC_Offset[11:4]	Offset within virtual vAPIC backing page at which read or write was attempted. APIC_Offset[3:0] = 0, since all registers are aligned on 16-byte boundaries.
3:0	—	Reserved.

**EXITINFO2.** This field contains extra information for the un-accelerated operation. If the EXITINFO1 fields indicate a write to the vAPIC EOI register (offset = B0h), bits 7:0 of this value contain the number of the highest in-service vector found in the virtual APIC ISR.

63	8	7	0
Reserved		Vector	

Table 15-30. EXTINFO2 Fields

Bit(s)	Field Name	Description
63:8	—	Reserved.
31:0	Vector	Vector for attempted EOI; otherwise undefined.

## 15.30 SVM Related MSRs

SVM uses the following MSRs for various control purposes. These MSRs are available regardless of whether SVM is enabled in EFER.SVME. For details on implementation-specific features, see the *BIOS and Kernel Developer's Guide* applicable to your product.

### 15.30.1 VM\_CR MSR (C001\_0114h)

The VM\_CR MSR controls certain global aspects of SVM. The layout of the MSR is shown in Figure 15-25.

63	5	4	3	2	1	0	
Reserved, MBZ			SVMDIS	LOCK	DIS_A20M	R_INIT	DPD

Figure 15-25. Layout of VM\_CR MSR (C001\_0114h)

The individual fields are as follows:

- DPD—Bit 0. If set, disables HDT and certain internal debug features.
- R\_INIT—Bit 1. If set, non-intercepted INIT signals are converted into an #SX exception.

- DIS\_A20M—Bit 2. If set, disables A20 masking.
- LOCK—Bit 3. When this bit is set, writes to LOCK and SVMDIS are silently ignored. When this bit is clear, VM\_CR bits 3 and 4 can be written. Once set, LOCK can only be cleared using the SVM\_KEY MSR (See Section 15.31, “SVM-Lock,” on page 527.) This bit is not affected by INIT or SKINIT.
- SVMDIS—Bit 4. When this bit is set, writes to EFER treat the SVM bit as MBZ. When this bit is clear, EFER.SVME can be written normally. This bit does not prevent CPUID from reporting that SVM is available. Setting SVMDIS while EFER.SVME is 1 generates a #GP fault, regardless of the current state of VM\_CR.LOCK. This bit is not affected by SKINIT. It is cleared by INIT when LOCK is cleared to 0; otherwise, it is not affected.

### 15.30.2 IGNNE MSR (C001\_0115h)

The read/write IGNNE MSR is used to set the state of the processor-internal IGNNE signal directly. This is only useful if IGNNE emulation has been enabled in the HW\_CR MSR (and thus the external signal is being ignored). Bit 0 specifies the current value of IGNNE; all other bits are MBZ.

### 15.30.3 SMM\_CTL MSR (C001\_0116h)

The write-only SMM\_CTL MSR provides software control over SMM signals.

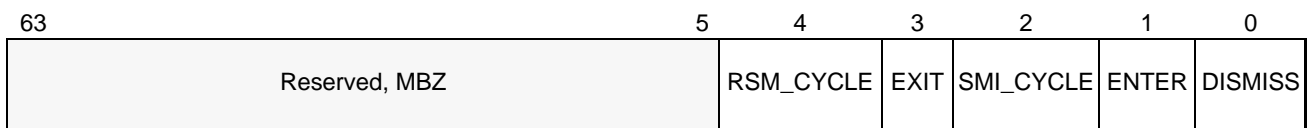

**Figure 15-26. Layout of SMM\_CTL MSR (C001\_0116h)**

Writing individual bits causes the following actions:

- DISMISS—Bit 0. Clear the processor-internal “SMI pending” flag.
- ENTER—Bit 1. Enter SMM: map the SMRAM memory areas, record whether NMI was currently blocked and block further NMI and SMI interrupts.
- SMI\_CYCLE—Bit 2. Send SMI special cycle.
- EXIT—Bit 3. Exit SMM: unmap the SMRAM memory areas, restore the previous masking status of NMI and unconditionally reenables SMI.
- RSM\_CYCLE—Bit 4. Send RSM special cycle.

Writes to the SMM\_CTL MSR cause a #GP if platform firmware has locked the SMM control registers by setting HWCR[SMMLOCK].

Conceptually, the bits are processed in the order of ENTER, SMI\_CYCLE, DISMISS, RSM\_CYCLE, EXIT, though only the following bit combinations may be set together in a single write (for all other combinations of more than one bit, behavior is undefined):

- ENTER + SMI\_CYCLE

- DISMISS + ENTER
- DISMISS + ENTER + SMI\_CYCLE
- EXIT + RSM\_CYCLE

The VMM must ensure that ENTER and EXIT operations are properly matched, and *not* nested, otherwise processor behavior is undefined. Also undefined are ENTER when the processor is already in SMM, and EXIT when the processor is not in SMM.

#### 15.30.4 VM\_HSAVE\_PA MSR (C001\_0117h)

The 64-bit read/write VM\_HSAVE\_PA MSR holds the physical address of a 4KB block of memory where VMRUN saves host state, and from which #VMEXIT reloads host state. The VMM software is expected to set up this register before issuing the first VMRUN instruction. Software must not attempt to read or write the host save-state area directly.

Writing this MSR causes a #GP if:

- any of the low 12 bits of the address written are nonzero, or
- the address written is greater than or equal to the maximum supported physical address for this implementation.

#### 15.30.5 TSC Ratio MSR (C000\_0104h)

Writing to the TSC Ratio MSR allows the hypervisor to control the guest's view of the Time Stamp Counter. The contents of TSC Ratio MSR sets the value of the TSCRatio. This constant scales the timestamp value returned when the TSC is read by a guest via the RDTSC or RDTSCP instructions or when the TSC, MPERF, or MPerfReadOnly MSRs are read via the RDMSR instruction by a guest running under virtualization.

This facility allows the hypervisor to provide a consistent TSC, MPERF, and MPerfReadOnly rate for a guest process when moving that process between cores that have a differing P0 rate. The TSCRatio does not affect the value read from the TSC, MPERF, and MPerfReadOnly MSRs when in host mode or when virtualization is disabled. System Management Mode (SMM) code sees unscaled TSC, MPERF and MPerfReadOnly values unless the SMM code is executed within a guest container. The TSCRatio value does not affect the rate of the underlying TSC, MPERF, and MPerfReadOnly counters, nor the value that gets written to the TSC, MPERF, and MPerfReadOnly MSRs counters on a write by either the host or the guest.

The TSC Ratio MSR specifies the TSCRatio value as a fixed-point binary number in 8.32 format, which is composed of 8 bits of integer and 32 bits of fraction. This number is the ratio of the desired P0 frequency to be presented to the guest relative to the P0 frequency of the core (See Section 17.1, “P-State Control,” on page 559). The reset value of the TSCRatio is 1.0, which sets the guest P0 frequency to match the core P0 frequency.

Note that:

$$\text{TSCFreq} = \text{Core P0 frequency} * \text{TSCRatio}, \text{ so } \text{TSCRatio} = (\text{Desired TSCFreq}) / \text{Core P0 frequency}.$$

The TSC value read by the guest is computed using the TSC Ratio MSR along with the TSC\_OFFSET field from the VMCB so that the actual value returned is:

$$\text{TSC Value (in guest)} = (\text{P0 frequency} * \text{TSCRatio} * t) + \text{VMCB.TSC\_OFFSET} + (\text{Last Value Written to TSC})$$

Where  $t$  is time since the TSC was last written via the TSC MSR (or since reset if not written)

The layout of the TSC Ratio MSR is illustrated in figure below.

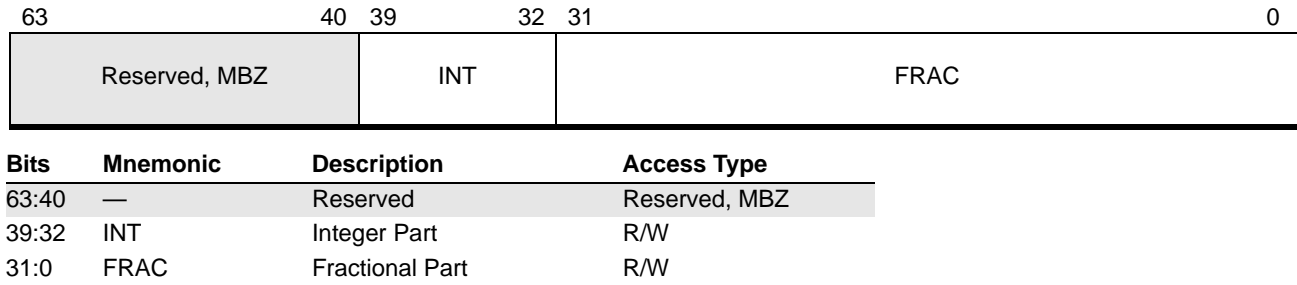

**Figure 15-27. TSC Ratio MSR (C000\_0104h)**

**INT.** Integer Part. Bits 39:32. Integer part of TSCRatio.

**FRAC.** Fractional Part. Bits 31:0. Fractional part of TSCRatio.

$$\text{TSCRatio} = \text{INT} + \text{FRAC} \times 2^{-32}$$

CPUID Fn8000\_000A\_EDX[TscRateMsr] = 1 indicates support for the TSC Ratio MSR. See Section 3.3, “Processor Feature Identification,” on page 63 for more information on using the CPUID instruction.

## 15.31 SVM-Lock

The SVM-Lock feature allows software to prevent EFER.SVME from being set, either unconditionally or with a 64-bit key to re-enable SVM functionality.

Support for SVM-Lock is indicated by CPUID Fn8000\_000A\_EDX[SVML] = 1. On processors that support the SVM-Lock feature, SKINIT and STGI can be executed even if EFER.SVME=0. See descriptions of LOCK and SVMDIS bits in Section 15.30.1, “VM\_CR MSR (C001\_0114h),” on page 524. When the SVM-Lock feature is not available, hypervisors can use the read-only VM\_CR.SVMDIS bit to detect SVM (see Section 15.4, “Enabling SVM,” on page 447).

### 15.31.1 SVM\_KEY MSR (C001\_0118h)

The write-only SVM\_KEY MSR is used to create a password-protected mechanism to clear VM\_CR.LOCK.

When VM\_CR.LOCK is zero, writes to SVM\_KEY MSR set the 64-bit SVM Key value.



When VM\_CR.LOCK is one, writes to SVM\_KEY MSR compare the written value to the SVM Key value; if the values match and are non-zero, the VM\_CR.LOCK bit is cleared. If the values mismatch or the SVM Key value is zero, the write to SVM\_KEY is ignored, and VM\_CR.LOCK is unmodified. Software should read VM\_CR.LOCK after writing SVM\_KEY to determine whether the unlock succeeded.

If SVM Key is zero when VM\_CR.LOCK is one, VM\_CR.LOCK can only be cleared by a processor reset.

To preserve the security of the SVM key, reading the SVM\_KEY MSR always returns zero.

## 15.32 SMM-Lock

The SMM-Lock feature allows software to prevent System Management Interrupts (SMI) from being intercepted in SVM. The SmmLock bit is located in the HWCR MSR register.

### 15.32.1 SmmLock Bit — HWCR[0]

The SmmLock bit (bit 0) is located in the HWCR MSR (C001\_0015h). When SmmLock is clear, it can be set to one. Once set, the bit cannot be cleared by software and writes to it are ignored. SmmLock can only be cleared using the SMM\_KEY MSR (see section 15.32.2), or by a processor reset. This bit is not affected by INIT or SKINIT. When SmmLock is set, other SMM configuration registers cannot be written. For complete information on the HWCR register, see the *BIOS and Kernel Developer's Guide* applicable to your product.

### 15.32.2 SMM\_KEY MSR (C001\_0119h)

The write-only SMM\_KEY MSR is used to create a password-protected mechanism to clear SmmLock.

When SmmLock is zero, writes to SMM\_KEY MSR set the 64-bit SMM Key value.

When SmmLock is one, writes to SMM\_KEY MSR compare the written value to the SMM Key value; if the values match and are non-zero, the SmmLock bit is cleared. If the values mismatch or the SMM Key value is zero, the write to SMM\_KEY is ignored, and SmmLock is unmodified. Software should read SmmLock after writing SMM\_KEY to determine whether the unlock succeeded.

If SMM\_Key MSR is equal to zero when SmmLock is one, SmmLock can only be cleared by a processor reset.

To preserve the security of the SMM key, reading SMM\_KEY MSR always returns zero.

## 15.33 Nested Virtualization

Hardware support for improved performance of nested virtualization -- the act of running a hypervisor as a guest under a higher-level hypervisor -- is provided through the features described here. These

relieve the top-level hypervisor from performing certain common, high-overhead operations that can occur with nested virtualization.

### 15.33.1 VMSAVE and VMLOAD Virtualization

This feature allows the VMSAVE and VMLOAD instructions to execute in Guest mode and not require a VMEXIT. The value in RAX for the VMSAVE or VMLOAD is treated as a guest physical address and is translated to the host physical address and then the instruction does its normal operation.

#### Presence

The presence of the virtualized VMSAVE and VMLOAD feature is indicated by CPUID 8000\_000A, EDX, bit 15.

#### Enablement

A new bit is added to the VMCB field at offset B8h.

Offset	Bit(s)	Description
B8h	1	Virtualized VMSAVE/VMLOAD (0 –Disabled, 1- Enabled)
B8h	63:2	Reserved

#### Usage

Virtualized VMSAVE/VMLOAD is enabled through a VMRUN with bit 1 set in offset B8 of the VMCB. It is only allowed when the hypervisor is in 64 bit mode and nested paging is enabled. This is not enforced on the execution VMRUN but is checked on execution of a VMSAVE/VMLOAD instruction with the virtualization feature enabled. If the host is not in the proper mode, a VMEXIT occurs with the VMSAVE/VMLOAD exit code. If it is in the proper mode the processor will translate the RAX as a guest physical address to a host physical address. Any page faults in attempting that translation will result in a normal VMEXIT with a nested page fault exit code. If the processor succeeds in translating the address, it will then finish the instruction with the normal loading or saving of register state.

### 15.33.2 Virtual GIF

This feature allows STGI and CLGI to execute in Guest mode and control virtual interrupts in guest mode while still allowing physical interrupts to be intercepted by the hypervisor.

#### Presence

The presence of the VGIF feature is indicated by CPUID 8000\_000A, EDX, bit 16.

#### Enablement and Usage

In order to provide this ability, two new bits are added to the VMCB field at offset 60h.

Offset	Bit(s)	Description
60h	9	VGIF value (0 – Virtual interrupts are masked, 1 – Virtual Interrupts are unmasked)
60h	25	AMD Virtual GIF enabled for this guest (0 - Disabled, 1 - Enabled)

When a VMRUN is executed and VGIF is enabled, the processor uses bit 9 as the starting value of the virtual GIF. It then provides masking capability for when virtual interrupts are taken. STGI executed in the guest sets bit 9 of the VMCB offset 60h and allows a virtual interrupt to be taken. CLGI executed in the guest clears bit 9 of the VMCB offset 60h and causes the virtual interrupt to be masked. Bit 9 in the VMCB is also writeable by the hypervisor and loaded on VMRUN and saved on VMEXIT.

The hypervisor can still use the STGI/SLGI intercept control in the VMCB.



## 16 Advanced Programmable Interrupt Controller (APIC)

The Advanced Programmable Interrupt Controller (APIC) provides interrupt support on AMD64 architecture processors. The local APIC accepts interrupts from the system and delivers them to the local CPU core interrupt handler.

Support for APIC is indicated by CPUID Fn0000\_0001\_EDX[APIC] = 1. For information on using the CPUID instruction to obtain processor implementation information, see Section 3.3, “Processor Feature Identification,” on page 63.

The APIC block diagram is provided in Figure 16-1.

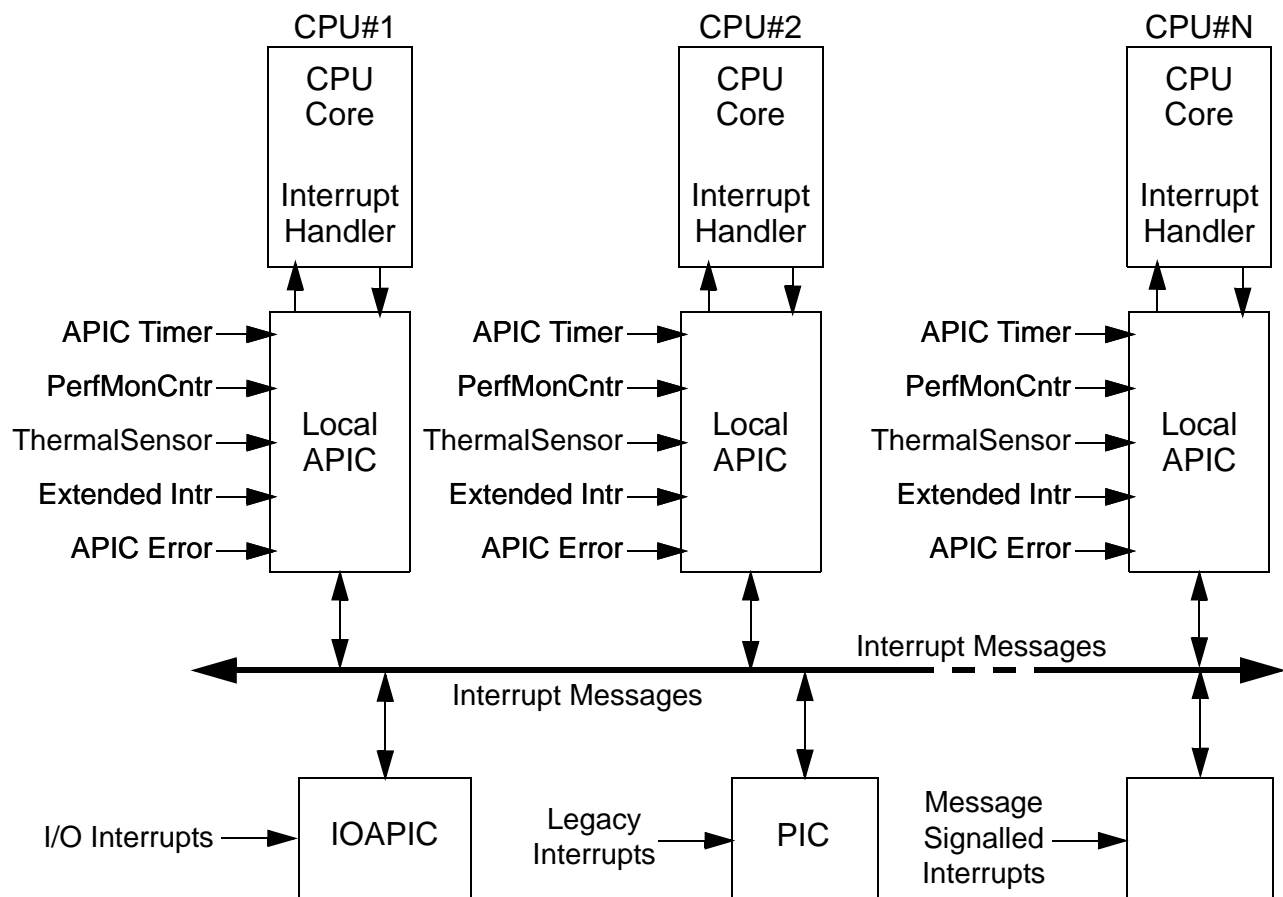

**Figure 16-1. Block Diagram of a Typical APIC Implementation**

## 16.1 Sources of Interrupts to the Local APIC

Each CPU core has an associated local APIC which receives interrupts from the following sources:

- I/O interrupts from the IOAPIC interrupt controller (including LINT0 and LINT1)
- Legacy interrupts (INTR and NMI) from the legacy interrupt controller
- Message Signalled Interrupts
- Interprocessor Interrupts (IPIs) from other local APICs. Interprocessor Interrupts are used to send interrupts or to execute system wide functions between CPU cores in the system, including the originating CPU core (self-interrupt).
- Locally generated interrupts within the local APIC. The local APIC receives local interrupts from the APIC timer, Performance Monitor Counters, thermal sensors, APIC errors and extended interrupts from implementation specific sources.

The sources of interrupts for the local APIC are provided in Table 16-1.

**Table 16-1. Interrupt Sources for Local APIC**

Source	Description	Message Type to Local APIC
I/O interrupts	System interrupts from I/O devices or system hardware received through the I/O APIC and sent to the local APIC as interrupt messages. They may be edge-triggered or level-sensitive.	Fixed, Lowest Priority, SMI, NMI, INIT, Restart, External interrupt, LINT0, LINT1
Legacy Interrupts	Legacy interrupts (INT and NMI) from the PIC and sent to the local APIC as interrupt messages.	NMI, INT
Interprocessor (IPI)	Interprocessor interrupts. Used for interrupt forwarding, system-wide functions, or software self-interrupts.	Fixed, lowest priority, SMI, read request, NMI, INIT, Restart, External interrupt
APIC Timer	Local interrupt from the programmed APIC timer reaches zero, under control of TIMER_LVT.	Fixed
Performance Monitor Counter	Local interrupt from the performance monitoring counter when it overflows, under control of PERF_CNT_LVT.	Fixed, SMI, or NMI
Thermal Sensor	Local interrupt from internal thermal sensors when it has tripped, under control of THERMAL_LVT.	Fixed, SMI, or NMI
Extended Interrupt[3:0]	Local Interrupts from programmable internal CPU core sources, under the control of the EXTENDED_INTERRUPT[3:0]_LVT.	Fixed, SMI, NMI, or External interrupt
APIC Internal Error	Local interrupt when an error is detected within the local APIC, under control of ERROR_LVT.	Fixed, SMI, or NMI

## 16.2 Interrupt Control

I/O, legacy, and interprocessor interrupts are sent via interrupt messages. The interrupt messages contain the following information:

- Destination address of the local APIC.
- VECTOR[7:0] indicating interrupt priority of up to 256 interrupt vectors. This information is captured in the IRR register for Fixed and Lowest Priority interrupt message types.
- Trigger Mode indicating edge triggered or level-sensitive (which requires an EOI response to the source).
- Message Type[3:0] indicating the type of interrupt to be presented to the local APIC. For Fixed and Lowest Priority message types, the interrupt is processed through the target local APIC. For all other message types, the interrupt is sent directly to the destination CPU core. There is a 5-line interrupt interface to the CPU core for INTR, SMI, NMI, INIT and STARTUP interrupts. For locally-generated interrupts, control is provided by local vector tables or LVTs. Separate LVTs are provided for each interrupt source, allowing for unique entry point for each source. The LVT contains the VECTOR[7:0], trigger mode and message type as well as other fields associated with the specific interrupt. The message type may be Fixed, SMI, NMI, or External interrupt. A Mask bit is also provided to mask the interrupt.

## 16.3 Local APIC

### 16.3.1 Local APIC Enable

The local APIC is controlled by the APIC enable bit (AE) in the APIC Base Address Register (MSR 0000\_001Bh). See Figure 16-2 on page 534.

When AE is set to 1, the local APIC is enabled and all interrupt types are accepted. When AE is cleared to 0, the local APIC is disabled, including all local vector table interrupts.

Software can disable the local APIC, using the APIC\_SW\_EN bit in the Spurious Interrupt Vector Register (APIC\_F0). When this bit is cleared to zero, the local APIC is temporarily disabled:

- SMI, NMI, INIT, Startup, and Remote Read interrupts may be accepted.
- Pending interrupts in the ISR and IRR are held.
- Further fixed, lowest-priority, and ExtInt interrupts are not accepted.
- All LVT entry mask bits are set and cannot be cleared.

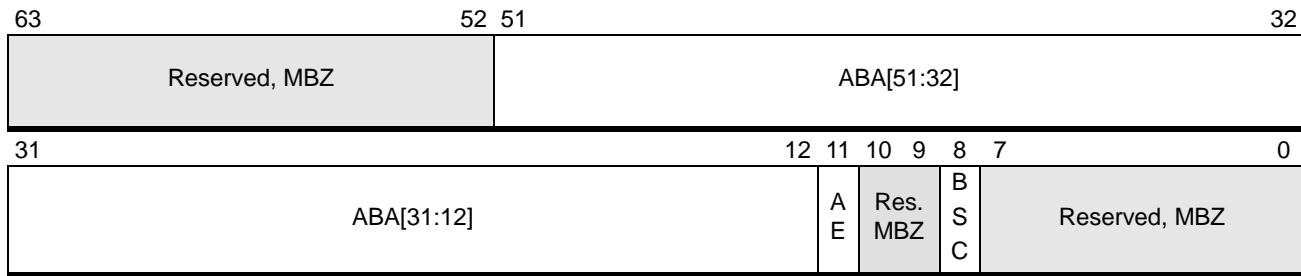

Bits	Mnemonic	Description	Access Type
63:52	—	Reserved, MBZ	
51:12	ABA	APIC Base Address	R/W
11	AE	APIC Enable	R/W
8	BSC	Boot Strap CPU Core	RO
7:0	Reserved	Reserved, Must be Zero	

**Figure 16-2. APIC Base Address Register (MSR 0000\_001Bh)**

The fields within the APIC Base Address register are as follows:

- *Boot Strap CPU Core (BSC)*—Bit 8. The BSC bit indicates that this CPU core is the boot core of the BSP. Each CPU core that is not the boot core of the boot processor is an AP (Application Processor).
- *APIC Enable (AE)*—Bit 11. This is the APIC enable bit. The local APIC is enabled and all interruption types are accepted when AE is set to 1. Clearing AE to 0 disables the local APIC, and no local vector table interrupts are supported.
- *APIC Base Address (ABA)*—Bits 51:12. Specifies the base physical address for the APIC register set. The address is extended by 12 bits at the least-significant end to form the 52-bit physical base address. The reset value of the APIC base address is 0\_0000\_FEE0\_0000h.

Note that a given processor may implement a physical address less than 52 bits in length.

### 16.3.2 APIC Registers

The system programming interface of the local APIC is made up of the registers listed in Table 16-2 below. All APIC registers are memory-mapped into the 4-Kbyte APIC register space, and are accessed with memory reads and writes. The memory address is indicated as:

$$\text{APIC Register address} = \text{APIC Base Address} + \text{Offset}$$

where the APIC Base Address must point to an uncacheable memory region, and is located in APIC Base Address Register, MSR 0000\_001Bh. See Figure 16-2.

APIC registers are aligned to 16-byte offsets and must be accessed using naturally-aligned DWORD size read and writes. All other accesses cause undefined behavior.

The table includes the value of each register after reset.



Table 16-2. APIC Registers

Offset	Name	Reset
20h	APIC ID Register	??000000h
30h	APIC Version Register	80??0010h
80h	Task Priority Register (TPR)	00000000h
90h	Arbitration Priority Register (APR)	00000000h
A0h	Processor Priority Register (PPR)	00000000h
B0h	End of Interrupt Register (EOI)	–
C0h	Remote Read Register	00000000h
D0h	Logical Destination Register (LDR)	00000000h
E0h	Destination Format Register (DFR)	FFFFFFFF
F0h	Spurious Interrupt Vector Register	000000FFh
100-170h	In-Service Register (ISR)	00000000h
180-1F0h	Trigger Mode Register (TMR)	00000000h
200-270h	Interrupt Request Register (IRR)	00000000h
280h	Error Status Register (ESR)	00000000h
300h	Interrupt Command Register Low (bits 31:0)	00000000h
310h	Interrupt Command Register High (bits 63:32)	00000000h
320h	Timer Local Vector Table Entry	00010000h
330h	Thermal Local Vector Table Entry	00010000h
340h	Performance Counter Local Vector Table Entry	00010000h
350h	Local Interrupt 0 Vector Table Entry	00010000h
360h	Local Interrupt 1 Vector Table Entry	00010000h
370h	Error Vector Table Entry	00010000h
380h	Timer Initial Count Register	00000000h
390h	Timer Current Count Register	00000000h
3E0h	Timer Divide Configuration Register	00000000h
400h	Extended APIC Feature Register	00040007h
410h	Extended APIC Control Register	00000000h
420h	Specific End of Interrupt Register (SEOI)	–
480-4F0h	Interrupt Enable Registers (IER)	FFFFFFFFh
500-530h	Extended Interrupt [3:0] Local Vector Table Registers	00000000h

### 16.3.3 Local APIC ID

Unique local APIC IDs are assigned to each CPU core in the system. The value is determined by hardware, based on the number of CPU cores on the processor and the node ID of the processor.

The APIC ID is located in the APIC ID register at APIC offset 20h. See Figure 16-3. It is model dependent, whether software can modify the APIC ID Register. The initial value of the APIC ID (after a reset) is the value returned in CUID function 0000\_0001h\_EBX[31:24].

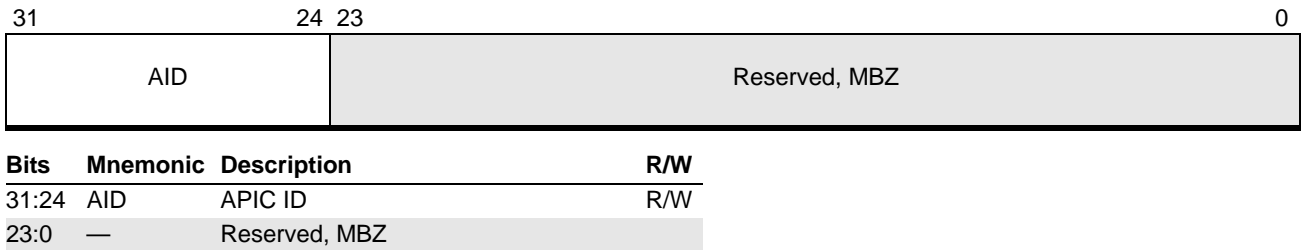

**Figure 16-3. APIC ID Register (APIC Offset 20h)**

- *APIC ID (AID)*—Bits 31:24. The APIC ID field contains the unique APIC ID value assigned to this specific CPU core. A given implementation may use some bits to represent the CPU core and other bits represent the processor.

**16.3.4 APIC Version Register**

A version register is provided to allow software to identify which APIC version is used. Bits 7:0 of the APIC Version Register indicate the version number of the APIC implementation.

The number of entries in the local vector table are specified in bits 23:16 of the register as the maximum number minus one.

Bit 31 indicates the presence of extended APIC registers which have an offset starting at 400h.

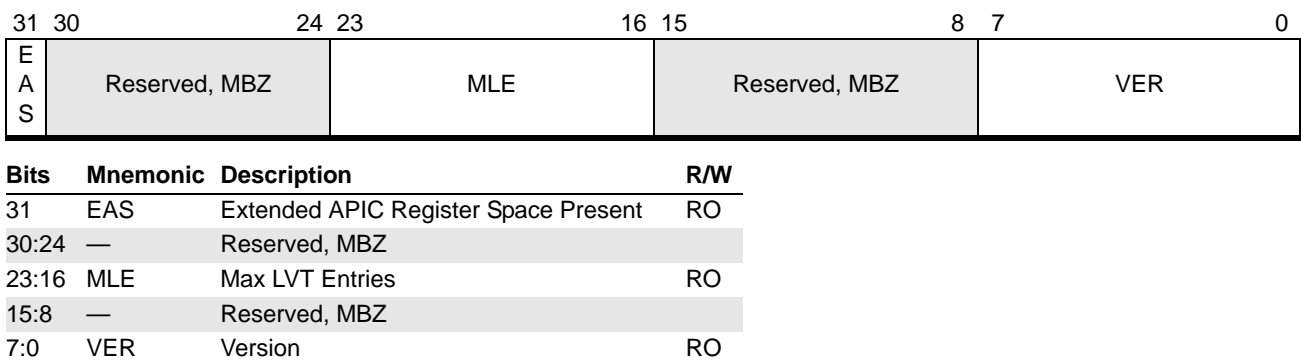

**Figure 16-4. APIC Version Register (APIC Offset 30h)**

The fields within the APIC Version register are as follows:

- *Version (VER)*—Bits 7:0. The VER field indicates the version number of the APIC implementation. The local APIC implementation is identified with a value=1Xh (20h-FFh are reserved).
- *Max LVT Entries (MLE)*—Bits 23:16. The MLE field specifies the number of entries in the local vector table minus one.
- *Extended APIC Register Space Present (EAS)*—Bit 31. The EAS bit when set to 1 indicates the presence of an extended APIC register space, starting at offset 400h.

### 16.3.5 Extended APIC Feature Register

The Extended APIC Feature Register indicates the number of extended Local Vector Table registers in the local APIC, whether the Interrupt Enable Registers are present, and whether the 8-bit Extended APIC ID and Specific End Of Interrupt (SEOI) Register are supported.

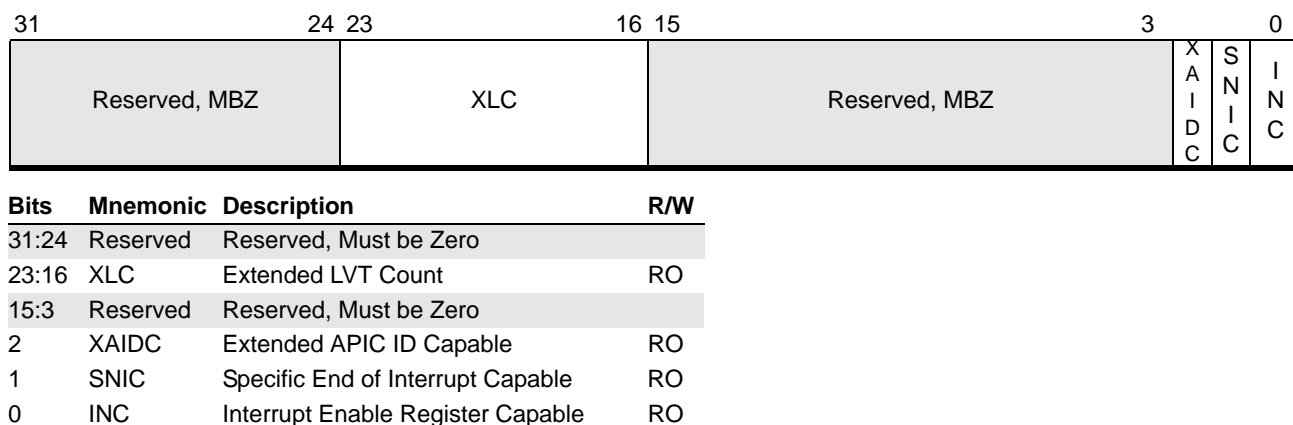
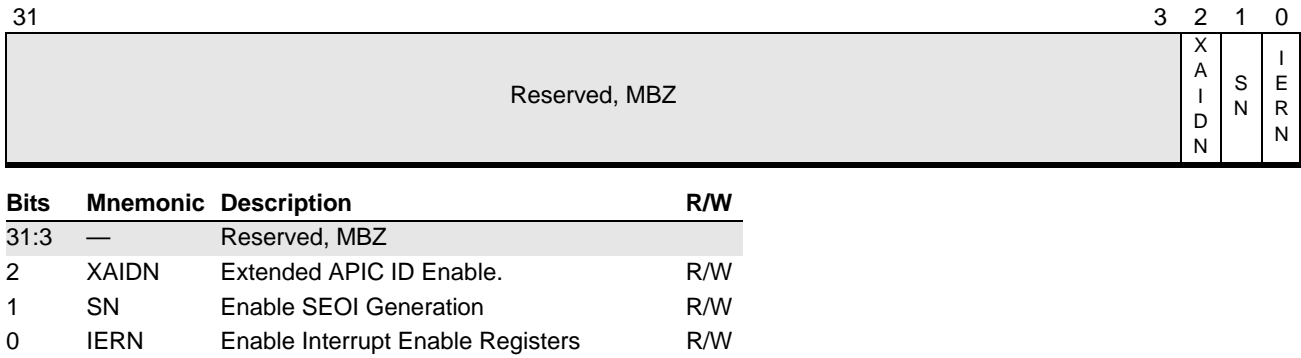

**Figure 16-5. Extended APIC Feature Register (APIC Offset 400h)**

- *Extended LVT Count (XLC)*—(Bits 23:16) Specifies the number of extended local vector table registers in the local APIC.
- *Extended APIC ID Capability (XAIDC)*—(Bit 2) Indicates that the processor is capable of supporting an 8-bit APIC ID.
- *Specific End of Interrupt Capable*—(Bit 1) Indicates that the Specific End Of Interrupt Register is present.
- *Interrupt Enable Register Capable*—(Bit 0) Read-only. Indicates that the Interrupt Enable Registers are present.

### 16.3.6 Extended APIC Control Register

This bit enables writes to the interrupt enable registers.



**Figure 16-6. Extended APIC Control Register (APIC Offset 410h)**

- Extended APIC ID Enable (XAIDN)—Bit 2. Setting XAIDN to 1 enables the upper four bits of the APIC ID field described in “APIC ID Register (APIC Offset 20h)” on page 536. Clearing this bit, specifies a 4-bit APIC ID using only the lower four bits of the APIC ID field of the APIC ID register.
- Enable SEOI Generation (SN)—Bit 1. Read-write. This bit enables Specific End of Interrupt (SEOI) generation when a write to the specific end of interrupt register is received.
- Enable Interrupt Enable Registers (IERN)—Bit 0. This bit enables writes to the interrupt enable registers.

## 16.4 Local Interrupts

The local APIC handles the following local interrupts:

- APIC Timer
- Local Interrupt 0 (LINT0)
- Local Interrupt 1 (LINT1)
- Performance Monitor Counters
- Thermal Sensors
- APIC internal error
- Extended (Implementation dependent)

A separate entry in the local vector table is provided for each interrupt to allow software to specify:

- Whether the interrupt is masked or not.
- The delivery status of the interrupt.
- The message type.
- The unique address vector.
- For LINT0 and LINT1 interrupts, the trigger mode, remote IRR, and input pin polarity.

- For the APIC timer interrupt, the timer mode.

The general format of a Local Vector Table Register is shown in Figure 16-7.

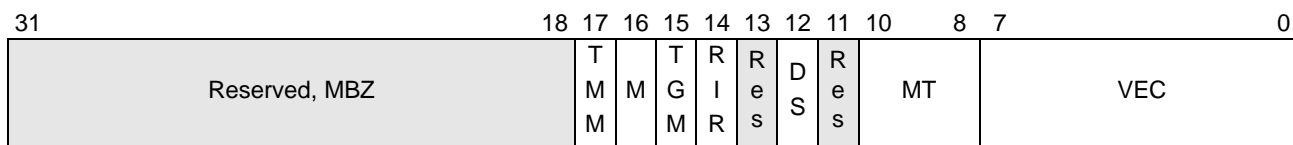

Bits	Mnemonic	Description	R/W
31:18	—	Reserved, MBZ	
17	TMM	Timer Mode	R/W
16	M	Mask	R/W
15	TGM	Trigger Mode	R/W
14	RIR	Remote IRR	RO
13	—	Reserved, MBZ	
12	DS	Delivery Status	RO
11	—	Reserved, MBZ	
10:8	MT	Message Type	R/W
7:0	VEC	Vector	R/W

**Figure 16-7. General Local Vector Table Register Format**

The fields within the General Local Vector Table register are as follows:

- *Vector (VEC)*—Bits 7:0. The VEC field contains the vector that is sent for this interrupt source when the message type is fixed. It is ignored when the message type is NMI and is set to 00h when the message type is SMI. Valid values for the vector field are from 16 to 255. A value of 0 to 15 when the message type is fixed results in an illegal vector APIC error.
- *Message Type (MT)*—Bits 10:8. The MT field specifies the delivery mode sent to the CPU core interrupt handler. The legal values are:
  - 000b = Fixed - The vector field specifies the interrupt delivered.
  - 010b = SMI - An SMI interrupt is delivered. In this case, the vector field should be set to 00h.
  - 100b = NMI - A NMI interrupt is delivered with the vector field being ignored.
  - 111b = External interrupt is delivered.
- *Delivery Status (DS)*—Bit 12. The DS bit indicates the interrupt delivery status. The DS bit is set to 1 when the interrupt is pending at the CPU core interrupt handler. After a successful delivery of the interrupt, the associated bit in the IRR is set and this bit is cleared to zero. See Section 16.6.2, “Lowest Priority Messages and Arbitration,” on page 550 for details. The bit is cleared to 0 when the interrupt is idle.
- *Remote IRR (RIR)*—Bit 14. The RIR bit is set to 1 when the local APIC accepts an LINT0 or LINT1 interrupt with the trigger mode=1 (level sensitive). The bit is cleared to 0 when the interrupt completes, as indicated when an EOI is received.

- *Trigger Mode (TGM)*—Bit 15. Specifies how interrupts to the local APIC are triggered. The TGM bit is set to 1 when the interrupt is level-sensitive. It is cleared to 0 when the interrupt is edge-triggered. When the message type is SMI or NMI, the trigger mode is edge triggered.
- *Mask (M)*—Bit 16. When the M bit is set to 1, reception of the interrupt is disabled. When the M bit is cleared to 0, reception of the interrupt is enabled.
- *Timer Mode (TMM)*—Bit 17. Specifies the timer mode for the APIC Timer interrupt. The TMM bit set to 1 indicates periodic timer interrupts. The TMM bit cleared to 0 indicates one-shot operation.

### 16.4.1 APIC Timer Interrupt

The APIC timer is a programmable 32-bit counter used by software to time operations or events. The timer can operate in two modes, periodic and one-shot, under the control of bit 17 (Timer Mode) in APIC Timer Local Vector Table Register (see Figure 16-8). In one-shot mode, the APIC timer is set to a programmable initial value and decrements at a programmable clock rate. When the timer value reaches zero, an APIC timer interrupt is generated under the control of bit 16 (Mask) in the APIC Timer Local Vector Table Register. In periodic mode, the APIC timer is initialized again when it reaches zero, and it starts to decrement again. Another APIC timer interrupt is generated when the timer value reaches zero.

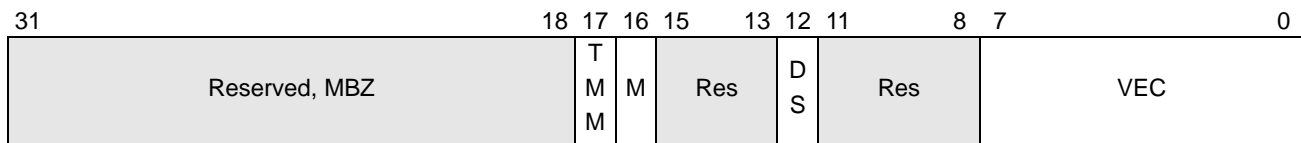

**Figure 16-8. APIC Timer Local Vector Table Register (APIC Offset 320h)**

Three APIC registers are defined for the APIC timer function:

- **Current Count Register (CCR)** is the actual APIC timer. It is initialized to a start count loaded from the ICR and then decrements. The APIC timer interrupt is generated when the CCR value reaches zero. The counting rate is controlled by the DCR. See Figure 16-9.
- **Initial Count Register (ICR)** contains the start count value for the APIC timer. See Table 16-10.
- **Divide Configuration Register (DCR)** controls the counting rate of the APIC timer by dividing the CPU core clock by a programmable amount. See Figure 16-11. For the specific details on the implementation of the APIC timer base clock rate, see the *BIOS and Kernel Developer's Guide* applicable to your product.

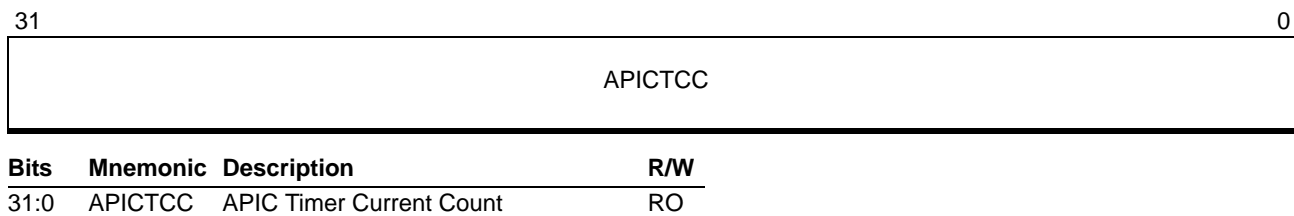

**Figure 16-9. Timer Current Count Register (APIC Offset 390h)**

- *APIC Timer Current Count (APICTCC)*—Bits 31:0. The APICTCC field contains the current value of the APIC timer.

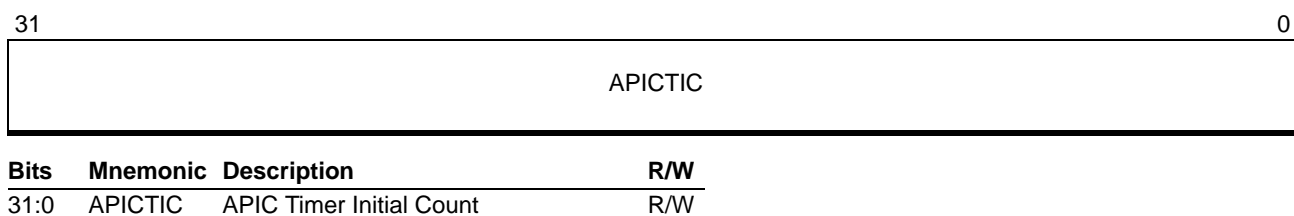

**Figure 16-10. Timer Initial Count Register (APIC Offset 380h)**

- *APIC Timer Initial Count (APICTIC)*—Bits 31:0. The APICTIC field contains the value that is loaded into the APIC Timer Current Count Register when the APIC timer is initialized.

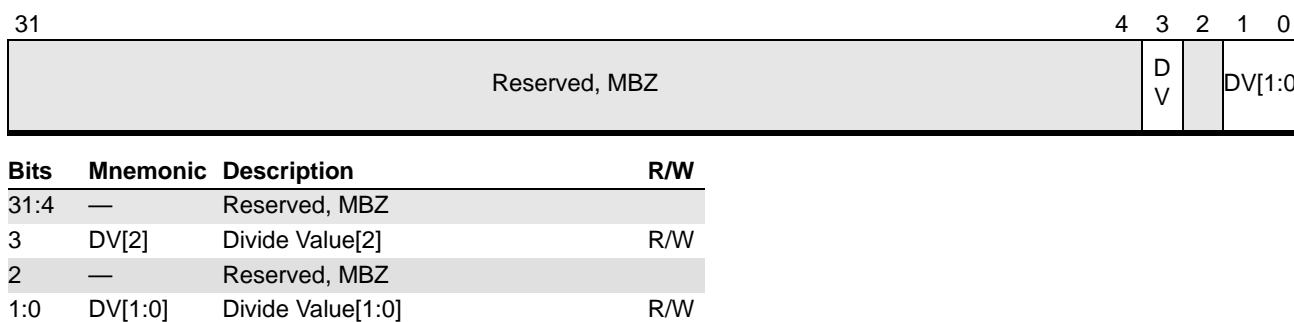

**Figure 16-11. Divide Configuration Register (APIC Offset 3E0h)**

- *Divide Value (DV)*—Bits 3, 1:0. The DV field specifies the value of the CPU core clock divisor. Table 16-3 lists the allowable values.

**Table 16-3. Divide Values**

Bits 3, 1:0	Resulting Timer Divide
000b	Divide by 2
001b	Divide by 4
010b	Divide by 8
011b	Divide by 16

Bits 3, 1:0	Resulting Timer Divide
100b	Divide by 32
101b	Divide by 64
110b	Divide by 128
111b	Divide by 1

### 16.4.2 Local Interrupts LINT0 and LINT1

When the target local APIC receives an interrupt message from an IOAPIC with the LINT0 or LINT1 message type, the appropriate local interrupt is generated under the control of bit 16 (Mask) in the APIC LINT0 or LINT1 Local Vector Table Register. See Figure 16-12.

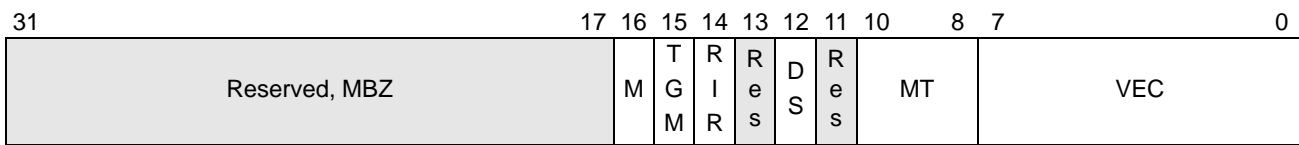

**Figure 16-12. Local Interrupt 0/1 (LINT0/1) Local Vector Table Register (APIC Offset 350h/360h)**

In addition to the normal LVT control bits (mask, delivery status and vector offset), the LINT0/LINT1 interrupts provide the following controls:

- Trigger Mode - indicates whether the interrupt pin is edge triggered or level sensitive when the message type is fixed.
- Remote IRR - When the trigger mode indicates level, this flag is set when the local APIC accepts the interrupt, and is reset when the local APIC receives an EOI. When the flag is set, no additional local interrupt requests are sent to the local APIC, and they remain pending.

### 16.4.3 Performance Monitor Counter Interrupts

When a performance monitor counter overflows, an APIC interrupt is generated under the control of bit 16 (Mask) in the APIC Performance Monitor Counter Local Vector Table Register. See Figure 16-13 on page 542.

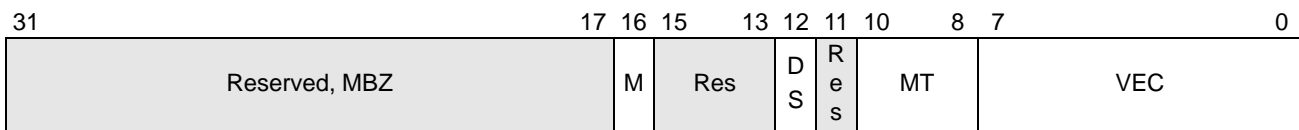
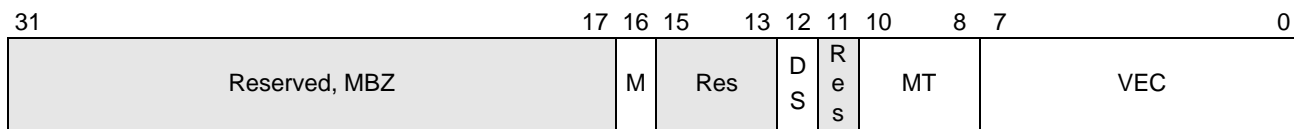

**Figure 16-13. Performance Monitor Counter Local Vector Table Register (APIC Offset 340h)**



#### 16.4.4 Thermal Sensor Interrupts

When a thermal event occurs, an APIC interrupt is generated under the control of bit 16 (Mask) in the APIC Thermal Sensor Local Vector Table Register. See Figure 16-14. See the *BIOS and Kernel Developer's Guide* applicable to your product for more information on thermal events. This interrupt may not be supported in all implementations.



**Figure 16-14. Thermal Sensor Local Vector Table Register (APIC Offset 330h)**

#### 16.4.5 Extended Interrupts

The local interrupts are extended to include more LVT registers, to allow additional interrupt sources. The additional sources are model dependent and can include:

- Counter overflow from the Machine Check Miscellaneous Threshold Register. See “Machine-Check Miscellaneous-Error Information Register 0(MCi\_MISC0)” on page 274 for details.
- ECC Error Count Threshold in memory system.
- Instruction Sampling.

The LVT register used for each interrupt source is specified by the control register associated with the source.

The Extended LVT Count field (bits 23:16) of the Extended APIC Feature Register specifies the number of extended LVT registers. Currently there are four additional LVT registers defined, Extended Interrupt [3:0], Local Vector Table Register, located at APIC offsets 500h–530h. (See section Section 16.7.1, “Specific End of Interrupt Register,” on page 556 and Figure 16-5 on page 537.)

#### 16.4.6 APIC Error Interrupts

Errors that are detected while handling interrupts cause an APIC error interrupt to be generated under the control of bit 16 (Mask) in the APIC Error Local Vector Table Register. See Figure 16-15 on page 543.

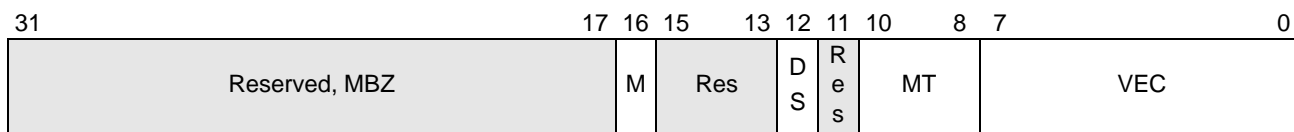
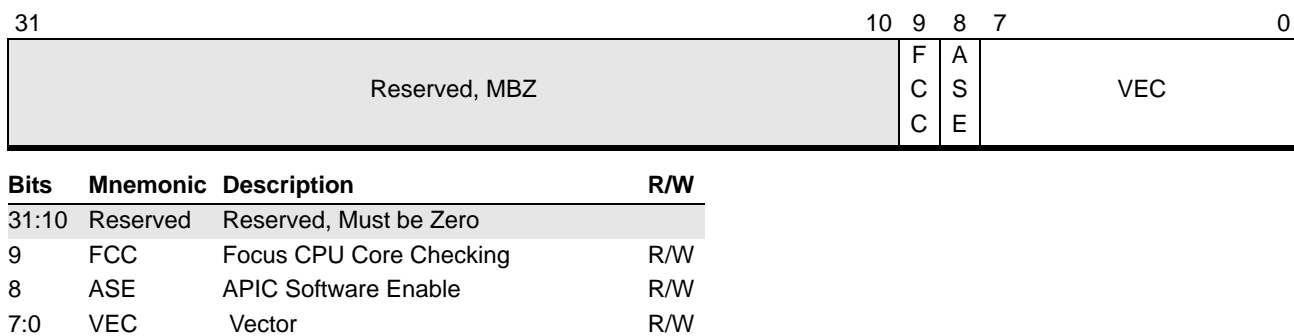

**Figure 16-15. APIC Error Local Vector Table Register (APIC Offset 370h)**



### 16.4.7 Spurious Interrupts

A timing issue exists between software and hardware that, though rare, results in spurious interrupts. In the event that the task priority is set to or above the level of the interrupt to be serviced while the interrupt is being acknowledged, the local APIC delivers a spurious interrupt to the CPU core instead, with the vector number specified by the Vector field of the Spurious Interrupt Register. The ISR is unaffected by the spurious interrupt, so the interrupt handler completes without sending an EOI back to the issuing local APIC.



**Figure 16-17. Spurious Interrupt Register (APIC Offset F0h)**

The fields within the Spurious Interrupt register are as follows:

- *Vector (VEC)*—Bits 7:0. The VEC field contains the vector that is sent to the CPU core in the event of a spurious interrupt.
- *APIC Software Enable (ASE)*—Bit 8. The ASE bit when set to 0 disables the local APIC temporarily. When the local APIC is disabled, SMI, NMI, INIT, Startup, Remote Read, and LINT interrupts may be accepted; pending interrupts in the ISR and IRR are held, but further fixed, lowest-priority, and ExtInt interrupts are not accepted. All LVT entry mask bits are set and cannot be cleared. Setting the ASE bit to 1, enables the local APIC.
- *Focus CPU Core Checking (FCC)*—Bit 9. The FCC bit when set to 1 disables focus CPU core checking when the lowest-priority message type is used. A CPU core is the focus of an interrupt if it is already servicing that interrupt (ISR=1) or if it has a pending request for that interrupt (IRR=1). Clearing the FCC bit to 0 disables focus CPU core checking.

## 16.5 Interprocessor Interrupts (IPI)

A local APIC can send interrupts to other local APICs (or itself) using software-initiated Interprocessor Interrupts (IPIs) using the Interrupt Command Register (ICR). Writing into the low order doubleword of the ICR causes the IPI to be sent.

The ICR can issue the following types of interrupt messages:

- basic interrupt message to another local APIC, including forwarding an interrupt that was received but not serviced
- basic interrupt message to the same local APIC (self-interrupt)
- system management interrupt (SMI)
- remote read message to another local APIC to read one of its APIC registers.
- non-maskable interrupt (NMI) delivered to another local APIC
- initialization message (INIT) to a target local APIC to be reset to their INIT state and await a STARTUP IPI.
- startup message (SIPI) to the target local APICs, pointing to a start-up routine.

The format of the Interrupt Command Register is shown in Figure 16-18.

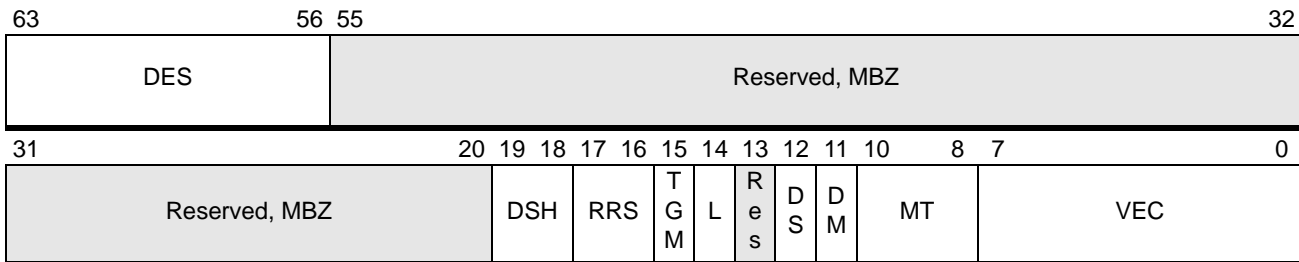

Bits	Mnemonic	Description	R/W
63:56	DES	Destination	R/W
55:20	—	Reserved, MBZ	
19:18	DSH	Destination Shorthand	R/W
17:16	RRS	Remote Read Status	RO
15	TGM	Trigger Mode	R/W
14	L	Level	R/W
13	—	Reserved, MBZ	
12	DS	Delivery Status	RO
11	DM	Destination Mode	R/W
10:8	MT	Message Type	R/W
7:0	VEC	Vector	R/W

**Figure 16-18. Interrupt Command Register (APIC Offset 300h–3010h)**

The fields within the Interrupt Command register are as follows:

- *Vector (VEC)*—Bits 7:0. The function of this field varies with the Message Type field. The VEC field contains the vector that is sent for this interrupt source for fixed and lowest priority message types.
- *Message Type (MT)*—Bits 10:8. The MT field specifies the message type sent to the CPU core interrupt handler. The legal values are:
  - 000b = Fixed - The IPI delivers an interrupt to the target local APIC specified in Destination field.

- 001b = Lowest Priority - The IPI delivers an interrupt to the local APIC executing at the lowest priority of all local APICs that match the destination logical ID specified in the Destination field. See Section 16.6.1, “Receiving System and IPI Interrupts,” on page 549.
  - 010b = SMI - The IPI delivers an SMI interrupt to target local APIC(s). The trigger mode is edge-triggered and the Vector field must = 00h.
  - 011b = Remote read - The IPI delivers a read request to read an APIC register in the target local APIC specified in Destination field. The trigger mode is edge triggered and the Vector field specifies the APIC offset of the APIC register to be read. The Remote Status field provides the current status of the remote read access after it has been issued. Data is returned from the target local APIC and captured in the Remote Read Register of the issuing local APIC. See Figure 16-19 on page 548.
  - 100b = NMI - The IPI delivers a non-maskable interrupt to the target local APIC specified in the Destination field. The Vector field is ignored.
  - 101b = INIT - The IPI delivers an INIT request to the target local APIC(s) specified in the Destination field, causing the CPU core to assume the INIT state. The trigger mode is edge-triggered, and the Vector field must =00h. In the INIT state, the target APIC is responsive only to the STARTUP IPI. All other interrupts (including SMI and NMI) are held pending until the STARTUP IPI has been accepted.
  - 110b = STARTUP - The IPI delivers a start-up request (SIPI) to the target local APIC(s) specified in Destination field, causing the CPU core to start processing the platform firmware boot-strap routine whose address is specified by the Vector field.
  - 111b = External interrupt - The IPI delivers an external interrupt to the target local APIC specified in Destination field. The interrupt can be delivered even if the APIC is disabled.
- *Destination Mode (DM)*—Bit 11. The DM bit when set to 1 specifies a logical destination which may be one or more local APICs with a common destination logical ID. When cleared to 0, the DM bit specifies a physical destination which indicates a single local APIC ID.
  - *Delivery Status (DS)*—Bit 12. The DS bit indicates the interrupt delivery status. The DS bit is set to 1 when the local APIC has sent the IPI and is waiting for it to be accepted by another local APIC (the ICR is not idle). Clearing the DS bit indicates that the target local APIC is idle. Code may repeatedly write ICRL without polling the DS bit; all requested IPIs will be delivered.
  - *Level (L)*—Bit 14. The L bit when set to 1 indicates assert. Clearing the L bit to 0 indicates deassert.
  - *Trigger Mode (TGM)*—Bit 15. Specifies how IPIs to the local APIC are triggered. The TGM bit is set to 1 when the interrupt is level-sensitive. It is cleared to 0 when the interrupt is edge-triggered.
  - *Remote Read Status (RRS)*—Bits 17:16. The RRS field indicates the current read status of a Remote Read from another local APIC. The encoding for this field is as follows:
    - 00b = Read was invalid
    - 01b = Delivery pending
    - 10b = Delivery done and access was valid. Data available in Remote Read Register.

- 11b = Reserved
- *Destination Shorthand (DSH)*—Bits 19:18. The DSH field indicates whether a shorthand notation is used, and provides a quick way to specify a destination for a message. It replaces the Destination field, when the destination field is not required (DSH > 00b), allowing software to use a single write to the low order ICR. The encoding are as follows:
  - 00b = Destination - The Destination field is required to specify the destination.
  - 01b = Self - The issuing APIC is the only destination.
  - 10b = All including self - The IPI is sent to all local APICs including itself (destination field=FFh).
  - 11b = All excluding self - The IPI is sent to all local APICs except itself (destination field=FFh).

Note that if the lowest priority is used, the message could end up being reflected back to this local APIC. If DS=1xb, the destination mode is ignored and physical is automatically used.
- *Destination (DES)*—Bits 63:56. The DES field identifies the target local APIC(s) for the IPI and contains the destination encoding used when the Destination Shorthand field=00b. The field indicates the target local APIC when the destination mode=0 (physical), and the destination logical ID (as indicated by LDR and DFR) when the destination mode=1 (logical).

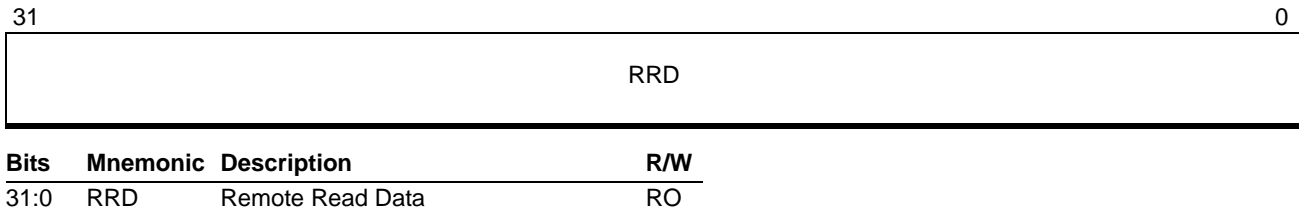

**Figure 16-19. Remote Read Register (APIC Offset C0h)**

- *Remote Read Data (RRD)*—Bits 31:0. The RRD field contains the data resulting from a valid completion of a remote read interprocessor interrupt.

Not all combinations of ICR fields are valid. Only the combinations indicated in Table 16-4 are valid.

**Table 16-4. Valid ICR Field Combinations**

Message Type	Trigger Mode	Level	Destination Shorthand
Fixed	Edge	x	x
	Level	Assert	x
Lowest Priority, SMI, NMI, INIT	Edge	x	Destination or all excluding self.
	Level	Assert	Destination or all excluding self
Startup	x	x	Destination or all excluding self

**Note:** x indicates a don't care.

## 16.6 Local APIC Handling of Interrupts

### 16.6.1 Receiving System and IPI Interrupts

Each local APIC verifies the destination ID, the destination mode and the message type of an APIC interrupt to determine if it is the target of the interrupt.

The destination mode is either physical or logical. In physical destination mode, the value of the interrupt message destination field is compared with the unique APIC ID value of each local APIC to select the target local APIC. If the destination field of the Interrupt Command Register is set to FFh, the interrupt is broadcasted and accepted by all local APICs. In physical destination mode, the lowest priority message type is not supported.

In logical destination mode, all local APICs use the Logical Destination Register and the Destination Format Register to determine if the interrupt is directed to them. The value of the interrupt message destination field is compared with the value in the Logical Destination Register (see Figure 16-20) of all local APICs.

The logical APIC ID must be unique. Since the comparison with the interrupt message destination field is on a bit-basis, there are only 8 unique logical IDs (01h, 02h, 04h, 08h, 10h, 20h, 40h, and 80h). For flat mode, the logical ID must be one of these values (for a total of eight local APICs supported). In cluster mode, the value of the logical ID is constrained to be  $xyh$ , where  $0 \leq x \leq Eh$  and  $y =$  either 1,2,4, or 8, for a total of  $(15 \times 4)$  possible unique logical IDs.

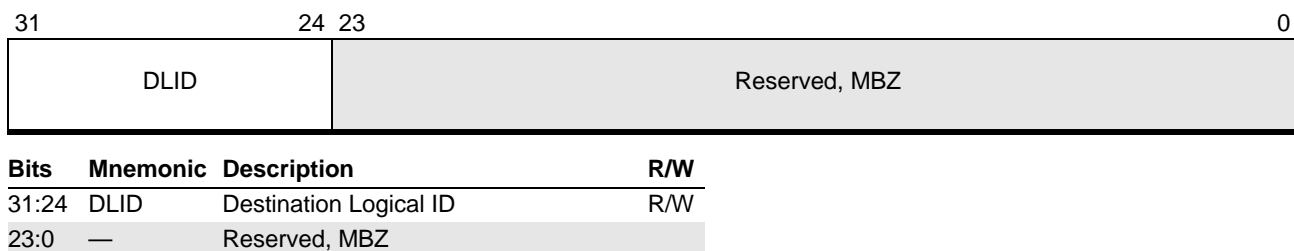

**Figure 16-20. Logical Destination Register (APIC Offset D0h)**

- *Destination Logical ID (DLID)*—Bits 31:24. The DLID field contains the logical APIC ID assigned to this specific CPU core. The logical APIC ID must be unique.

Two interrupt models are defined for the logical destination mode, the flat model and the cluster model, under the control of the Destination Format Register. See Figure 16-21.

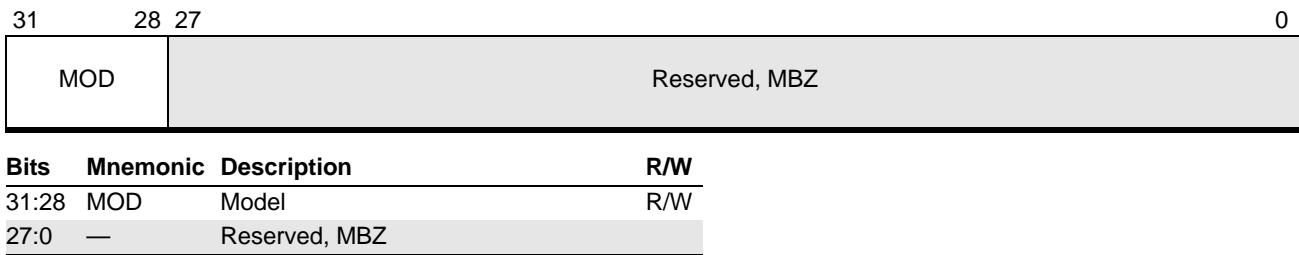

**Figure 16-21. Destination Format Register (APIC Offset E0h)**

- *Model (MOD)*—Bits 31:28. The MOD field controls which format to use when accepting interrupts in logical destination mode. The allowable values are 0h = cluster model and Fh = flat model.

With the flat model, up to eight unique logical APIC ID values can be provided by software by setting a different bit in the LDR. When the logical ID of the destination is compared with the LDR, if any bit position is set in both fields, this local APIC is a valid destination. A broadcast to all local APICs occurs when the LDR is set to all ones.

In the cluster model, bits 31:28 of the logical ID of the destination are compared with bits 31:28 of the LDR. If there is a match, then bits 27:24 are tested for matching ones, similar to the flat model. If bits 31:28 match, and any of bits 27:24 are set in both fields, this local APIC is a valid destination. The cluster model allows for 15 unique clusters to be defined, with each cluster having four unique logical APIC values to be addressed. In cluster logical destination mode, lowest priority message type is not supported.

In both the flat model and the cluster model, if the destination field = FFh, the interrupt is accepted by all local APICs.

### 16.6.2 Lowest Priority Messages and Arbitration

In the case where the interrupt is valid for several local APICs in logical destination mode with a lowest priority message type, the interrupt is accepted by the local APIC with the lowest arbitration priority, as indicated by the *Arbitration Priority* field in the Arbitration Priority Register (APR). The value in the *Arbitration Priority* field indicates the current priority for a pending interrupt or task, or an interrupt being serviced by the CPU core. See Figure 16-22.



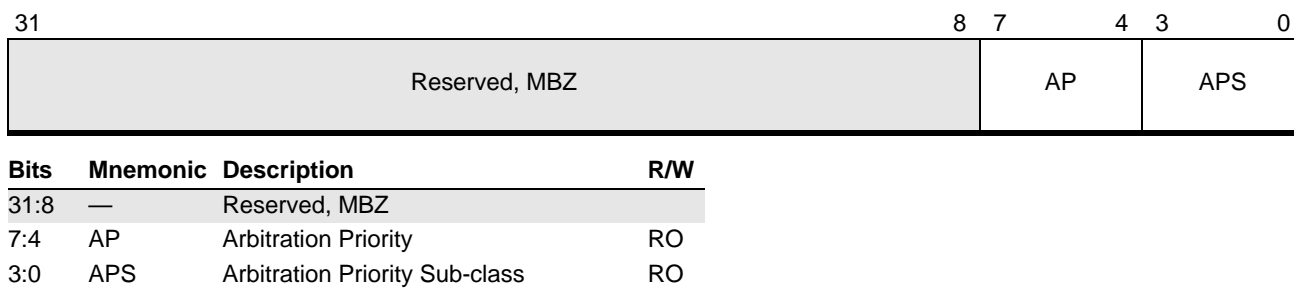

**Figure 16-22. Arbitration Priority Register (APIC Offset 90h)**

The fields within the Arbitration Priority register are as follows:

- *Arbitration Priority Sub-class (APS)*—Bits 3:0. The APS field indicates the current sub-priority to handle arbitrated interrupts to be serviced by the CPU core.
- *Arbitration Priority (AP)*—Bits 7:4. The AP field indicates the current priority to handle arbitrated interrupts to be serviced by the CPU core. The priority is used to arbitrate between CPU cores to determine which core accepts a lowest-priority interrupt request.

The value in the Arbitration Priority field is equal to the highest priority of the Task Priority field of the Task Priority Register (TPR), the highest bit set in the In-Service Register (ISR) vector, or the highest bit set in the Interrupt Request Register (IRR) vector. The value in the Arbitration Priority Sub-class field is equal to the Task Priority Sub-class if the APR is equal to the TPR, and zero otherwise.

If focus CPU core checking is enabled (Spurious Interrupt Register bit 9=0), the focus CPU core for an interrupt can always accept the interrupt. A CPU core is the focus of an interrupt if it is already servicing that interrupt (corresponding ISR bit is set) or if it already has a pending request for that interrupt (corresponding IRR bit is set). If there is no focus CPU core for an interrupt or if focus CPU core checking is disabled (Spurious Interrupt Register bit 9=1), all target local APICs identified as candidates for the interrupt arbitrate to determine which is executing with the lowest arbitration priority. If there is a tie for lowest priority, the local APIC with the highest APIC ID is selected.

### 16.6.3 Accepting System and IPI Interrupts

If the local APIC accepting the interrupt determines that the message type for the interrupt request indicates SMI, NMI, INIT, STARTUP or ExtINT, it sends the interrupt directly to the CPU core for handling. If the message type is fixed or lowest priority, the accepting local APIC places the interrupt into an open slot in either the IRR or ISR registers. If there is no free slot, the interrupt is rejected and sent back to the sender with a retry request.

Three 256-bit acceptance registers support interrupts accepted by the local APIC. Bits 255:16 correspond to interrupt vectors 255:16 with 255 being the highest priority; bits 15:0 are reserved.

- **Interrupt Request Register (IRR)**, which contains interrupt requests that have been accepted but have not been sent to the CPU core for interrupt handling. When a system interrupt is accepted, the associated bit corresponding to the interrupt vector is set in the IRR. When the CPU core requests a

new interrupt, the local APIC selects the highest priority IRR interrupt and sends it to the CPU core. The local APIC then sets the corresponding bit in the ISR and resets the associated IRR bit. See Figure 16-23 on page 552.

- In-Service Register (ISR) contains the bit map of the interrupts that have been sent to the CPU core and are still being serviced. When the CPU core writes to the EOI register indicating completion of the interrupt processing, the associated ISR bit is reset and a new interrupt is selected from the IRR register. If a higher priority interrupt is accepted by the local APIC while the CPU core is servicing another interrupt, the higher priority interrupt is sent directly to the CPU core (before the current interrupt finishes processing) and the associated IRR bit is set. The CPU core interrupts the current interrupt handler to service the higher priority interrupt. When the interrupt handler for the higher priority interrupt completes, the associated IRR bit is reset and the interrupt handler returns to complete the previous interrupt handler routine. If a second interrupt with the same interrupt vector number is received by the local APIC while the ISR bit is set, the local APIC sets the IRR bit. No more than two interrupts can be pending for the same interrupt vector number. Subsequent interrupt requests to the same interrupt vector number will be rejected. See Figure 16-24 on page 553.
- Trigger Mode Register (TMR) indicates the trigger mode of the interrupt and determines whether an EOI message is sent to the I/O APIC for level-sensitive interrupts. When the interrupt is accepted by the local APIC and the IRR bit is set, the associated TMR bit is set for level-sensitive interrupts or reset for edge-triggered interrupts. At the end of the interrupt handler routine, when the EOI is received at the local APIC, an EOI message is sent to the I/O APIC if the associated TMR bit is set for a system interrupt. See Figure 16-25 on page 553.

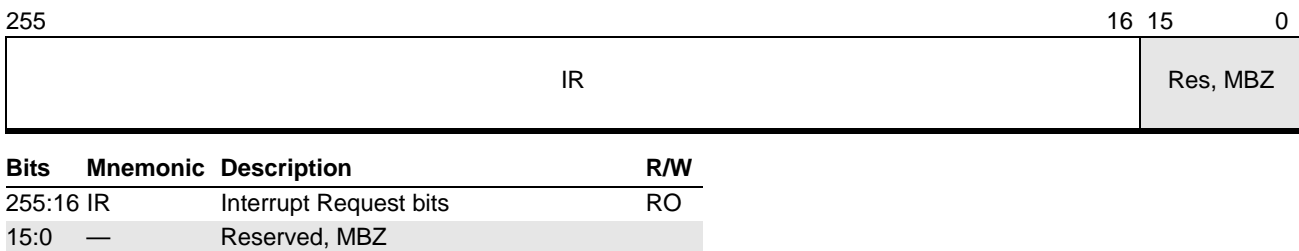
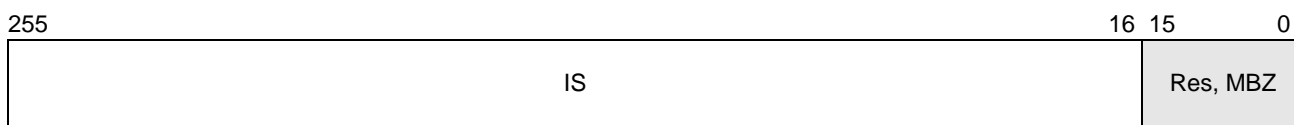

**Figure 16-23. Interrupt Request Register (APIC Offset 200h–270h)**

- *Interrupt Request bits (IR)*—Bits 255:16. The corresponding request bit is set when an interrupt is accepted by the local APIC. The interrupt request registers provide a bit per interrupt to indicate that the corresponding interrupt has been accepted by the local APIC. Interrupts are mapped as follows:

Register	Interrupt Number
IRR (APIC offset 200h)	31–16
IRR (APIC offset 210h)	63–32
IRR (APIC offset 220h)	95–64

Register	Interrupt Number
IRR (APIC offset 230h)	127–96
IRR (APIC offset 240h)	159–128
IRR (APIC offset 250h)	191–160
IRR (APIC offset 260h)	223–192
IRR (APIC offset 270h)	255–224



Bits	Mnemonic	Description	R/W
255:16	IS	In Service bits	RO
15:0	—	Reserved, MBZ	

**Figure 16-24. In Service Register (APIC Offset 100h–170h)**

- *In Service bits (IS)*—Bits 255:16. These bits are set when the corresponding interrupt is being serviced by the CPU core. The in-service registers provide a bit per interrupt to indicate that the corresponding interrupt is being serviced by the CPU core. Interrupts are mapped as follows:

Register	Interrupt Number
ISR (APIC offset 100h)	31–16
ISR (APIC offset 110h)	63–32
ISR (APIC offset 120h)	95–64
ISR (APIC offset 130h)	127–96
ISR (APIC offset 140h)	159–128
ISR (APIC offset 150h)	191–160
ISR (APIC offset 160h)	223–192
ISR (APIC offset 170h)	255–224

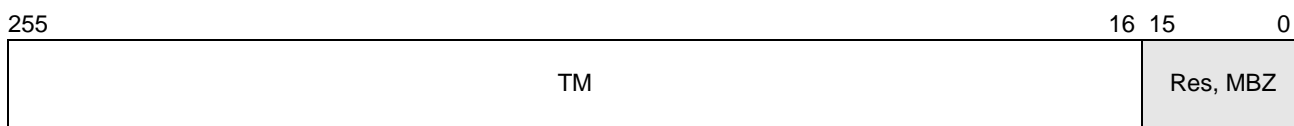

Bits	Mnemonic	Description	R/W
255:16	TM	Trigger Mode bits	RO
15:0	—	Reserved, MBZ	

**Figure 16-25. Trigger Mode Register (APIC Offset 180h–1F0h)**

- *Trigger Mode bits (TM)*—Bits 255:16. These bits provide a bit per interrupt to indicate the assertion mode of each interrupt. Interrupts are mapped as follows:

Register	Interrupt Number
TMR (APIC offset 180h)	31–16
TMR (APIC offset 190h)	63–32
TMR (APIC offset 1A0h)	95–64
TMR (APIC offset 1B0h)	127–96
TMR (APIC offset 1C0h)	159–128
TMR (APIC offset 1D0h)	191–160
TMR (APIC offset 1E0h)	223–192
TMR (APIC offset 1F0h)	255–224

### 16.6.4 Selecting and Handling Interrupts

Interrupts are selected by the local APIC for delivery to the CPU core interrupt handler on a priority determined by the interrupt vector number. Of the 15 priority levels, 15 is the highest and 1 is the lowest. The priority level for an interrupt is equal to the interrupt vector number divided by 16, rounded down to the nearest integer, with vectors 0Fh–00h reserved. Therefore, interrupt vectors 79h and 70h have the same priority level. The high-order hex digit indicates the priority level while the low-order hex digit indicates the priority within the same priority level.

Two registers are used to determine the priority threshold for selecting interrupts to be delivered to the CPU core, the Task Priority Register (TPR) and the Processor Priority Register (PPR). Software uses the TPR to set a priority threshold for interrupts to the CPU core, allowing the OS to block specific interrupts. See Figure 16-26 on page 554 for more details on the TPR.

The value in the *Task Priority* field is set by software to set a threshold priority at which the processor is to be interrupted. The value varies from 0 (all interrupts are allowed) to 15 (all interrupts with fixed delivery mode are inhibited). See Figure 16-26.



Bits	Mnemonic	Description	R/W
31:8	—	Reserved, Must be Zero	
7:4	TP	Task Priority	R/W
3:0	TPS	Task Priority Sub-class	R/W

**Figure 16-26. Task Priority Register (APIC Offset 80h)**

The fields within the Task Priority register are as follows:

- *Task Priority Sub-class (TPS)*—Bits 3:0. The TPS field indicates the current sub-priority to be used when arbitrating lowest-priority messages. This field is written with zero when TPR is written using the architectural CR8 register.
- *Task Priority (TP)*—Bits 7:4. The TP field indicates the current priority to be used when a core is deciding when to handle interrupts. A value of zero allows all interrupts; a value of Fh disables all interrupts. TP is also used to arbitrate between CPU cores to determine which core accepts a lowest-priority interrupt request. This field can also be written using the architectural CR8 register.

The PPR is set by the CPU core and represents the current priority level at which the CPU core is executing. The PPR determines whether a pending interrupt in the local APIC can be selected for interrupt handling in the CPU core. The value set by hardware is either the interrupt priority level of the highest priority ISR bit set or the value in the TPR, whichever is higher. The PPR is equal to the TPR when the CPU core is not servicing a higher priority interrupt. See Figure 16-27 on page 555.

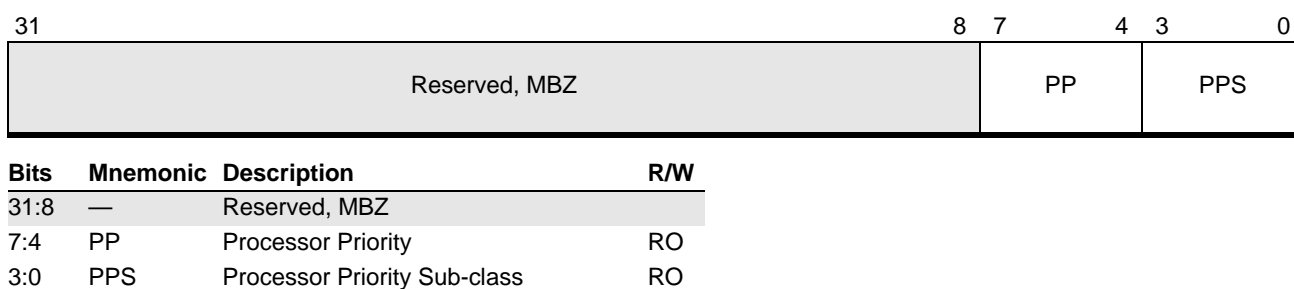

**Figure 16-27. Processor Priority Register (APIC Offset A0h)**

The fields within the Processor Priority register are as follows:

- *Processor Priority Sub-class (PPS)*—Bits 3:0. The PPS field is set to the Task Priority sub-class field of the Task Priority Register (TPR) if the PP field is equal to the Task Priority field of the TPR.
- *Processor Priority (PP)*—Bits 7:4. The PP field indicates the CPU core's current priority for servicing a task or interrupt, and is used to determine if any pending interrupts should be serviced. It is the higher value of either the interrupt priority level of the highest priority ISR bit set or the value in the TPR.

Pending interrupts must have a higher priority level than the value in the PPR to be selected by the local APIC for interrupt handling in the core; otherwise, they remain pending in the IRR until the PPR is lowered below the pending interrupt priority level. No pending interrupts are selected by the local APIC when the TPR=15.

The local APIC selects the highest priority pending interrupt (highest priority IRR) when the CPU core is ready, and sends the interrupt (with the IRR vector) to the CPU core. The local APIC resets the highest priority IRR bit and sets the associated ISR bit.

As part of the completion of the interrupt handling routine, software writes a value of zero to the End-of-Interrupt Register (EOI) in the local APIC, which causes the local APIC to reset the associated ISR bit. The EOI register is a write-only register.

If a higher priority interrupt is accepted by the local APIC while the CPU core is servicing another interrupt, the higher priority interrupt is sent directly to the CPU core (before the current interrupt finishes processing) and the associated ISR bit is set. The CPU core interrupts the current interrupt handler to service the higher priority interrupt. When the interrupt handler for the higher priority interrupt completes, the associated ISR bit is reset and the interrupt handler returns to complete the previous interrupt handler routine.

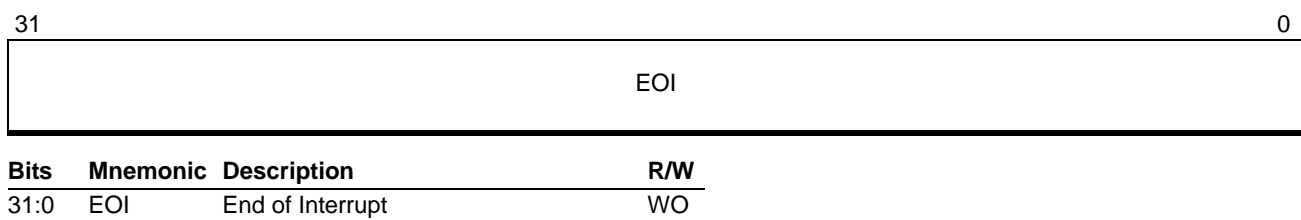

**Figure 16-28. End of Interrupt (APIC Offset B0h)**

- *End of Interrupt (EOI)*—Bits 31:0. Write-only operation signals end of interrupt processing to source of interrupt.

## 16.7 SVM Support for Interrupts and the Local APIC

The SVM hypervisor uses the Extended APIC Feature Register, Extended APIC Control Register, Specific End of Interrupt Register (SEOI), and Interrupt Enable Register (IER) to control virtualized interrupts. When guests have direct access to devices, interrupts arriving at the local APIC can usually be dismissed only by the guest that owns the device causing the interrupt. To prevent one guest from blocking other guests' interrupts (by never processing their own), the VMM can mask pending interrupts in the local APIC, so they do not participate in the prioritization of other interrupts.

### 16.7.1 Specific End of Interrupt Register

Software issues a specific EOI (SEOI) by writing the vector number of the interrupt to the SEOI register in the local APIC. The SEOI register is located at offset 420h in the APIC space. The SEOI register format is shown in Figure 16-29.

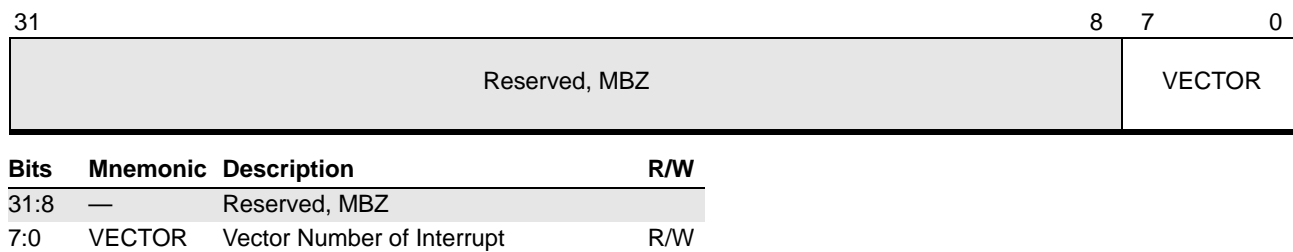

**Figure 16-29. Specific End of Interrupt (APIC Offset 420h)**

### 16.7.2 Interrupt Enable Register

The IER is made available to software by means of eight 32-bit registers in the local APIC; bit  $i$  of the 256-bit IER is located at bit position  $(i \bmod 32)$  in the local APIC register  $IER[i / 32]$ . The eight IER registers are located at offsets 480h, 490h, ..., 4F0h in APIC space. The IER format is shown in Figure 16-30.

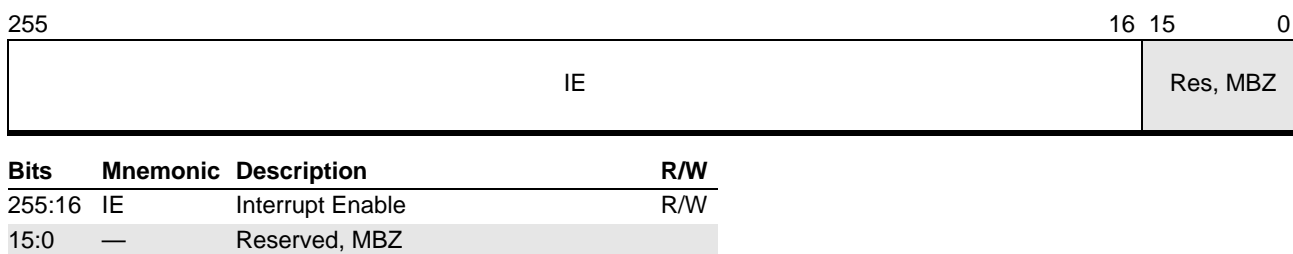

**Figure 16-30. Interrupt Enable Register (APIC Offset 480h–4F0h)**

- *Interrupt Enable (IE)*—Bits 255:16. Interrupts are mapped as follows:

Register	Interrupt Number
IER (APIC offset 480h)	31–16
IER (APIC offset 490h)	63–32
IER (APIC offset 4A0h)	95–64
IER (APIC offset 4B0h)	127–96
IER (APIC offset 4C0h)	159–128
IER (APIC offset 4D0h)	191–160
IER (APIC offset 4E0h)	223–192
IER (APIC offset 4F0h)	255–224

The IER and SEOI registers are located in the APIC Extended Space area. The presence of the APIC Extended Space area is indicated by bit 31 of the APIC Version Register (at offset 30h in APIC space).

The presence of the IER and SEOI functionality is identified by bits 0 and 1, respectively, of the APIC Extended Feature Register (located at offset 400h in APIC space). IER and SEOI are enabled by setting bits 0 and 1, respectively, of the APIC Extended Control Register (located at offset 410h).

Only vectors that are enabled in IER participate in APIC's computation of the highest-priority pending interrupt. The reset value of IER is all ones.



## 17 Hardware Performance Monitoring and Control

---

The AMD64 architecture provides several mechanisms by which software can monitor and control processor performance to optimize power use. The following lists the facilities that are described in the sections that follow:

- The P-state control interface allows dynamic control of performance states. See Section 17.1 which follows immediately below.
- Core performance boost (CPB) dynamically increases core clock rate beyond that defined for the P0 power state to achieve higher performance while maintaining power consumption below a preset level. See Section 17.2 on page 561.
- The effective frequency interface provides a measure of the actual core clock rate over a specified period of time. See Section 17.3 on page 562.
- The processor power reporting interface allows system software to measure average processor core power over a given time period. See Section 17.5 on page 565.

### 17.1 P-State Control

P-states are operational performance states (states in which the processor is executing instructions, that is, running software) characterized by a unique frequency of operation for a CPU core. The P-state control interface supports dynamic P-state changes in up to 16 P-states called P-states 0 through 15 or P0 through P15. P0 is the highest power, highest performance P-state; each ascending P-state number represents a lower-power, lower-performance state.

Core P-states are controlled by software. Each CPU core contains one set of P-state control registers. Software controls the P-states of each CPU core independently; however, hardware may include interdependencies that affect the P-state achieved by each core.

Hardware provides the highest P-state value in the PstateMaxVal field of the P-State Current Limit Register. P-states may be limited to a lower performance value under certain conditions. The current P-state limit is dynamic and is specified in the CurPstateLimit field of the P-State Current Limit Register.

Software requests a core P-state change by writing a 4-bit index corresponding to the desired core P-state number to the P-State Control Register of the appropriate core. For example, to request the P3 state for core 0, software writes 3h to the core 0's PstateCmd field in MSR C001\_0062h. If the P-state value is greater than the value in PstateMaxVal, the value written is clipped to that value.

As the current P-state limit changes, the P-state for the CPU core is either set to the software-requested P-state value or the new current P-state limit, whichever is the higher P-state value.

The current P-state value can be read using the P-State Status Register. The P-State Current Limit Register and the P-State Status Register are read-only registers. Writes to these registers cause a #GP exception. Support for hardware P-state control is indicated by CPUID Fn8000\_0007\_EDX[HwPstate] = 1. Figure 17-1 below shows the format of the P-State Current Limit register.

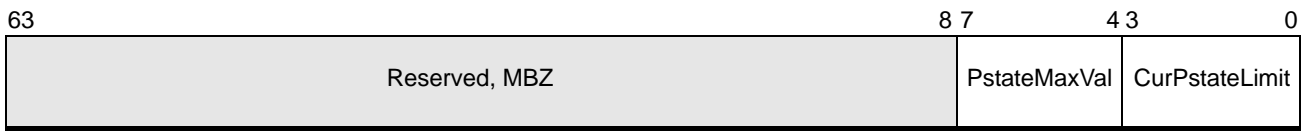

Bits	Mnemonic	Description	R/W
63:8	—	Reserved, MBZ	
7:4	PstateMaxVal	P-state maximum value	R
3:0	CurPstateLimit	Current P-state limit	R

**Figure 17-1. P-State Current Limit Register (MSR C001\_0061h)**

The fields within the P-State Current Limit register are:

- *Current P-State Limit (CurPstateLimit)*—Bits 3:0. Provides the current P-state limit, which is the lowest P-state value (highest-performance state) that is currently supported by the hardware. This is a dynamic value controlled by hardware. Reset value is implementation specific.
- *P-State Maximum Value (PstateMaxVal)*—Bits 7:4. Specifies the highest P-state value (lowest performance state) supported by the hardware. Attempts to change the current P-state number to a higher value by writes to the P-State Control Register are clipped to the value of this field. Reset value is implementation specific.

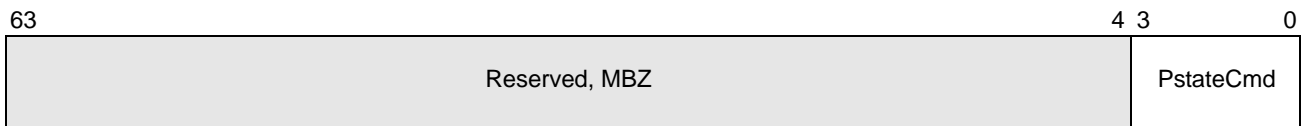

Bits	Mnemonic	Description	R/W
63:4	—	Reserved, MBZ	
3:0	PstateCmd	P-state change command	R/W

**Figure 17-2. P-State Control Register (MSR C001\_0062h)**

*P-State Change Command (PstateCmd)*—Bits 3:0. Writes to this field cause the CPU core to change to the indicated P-state number, which may be clipped by the PstateMaxVal field of the P-State Current Limit Register. Reset value is implementation specific.

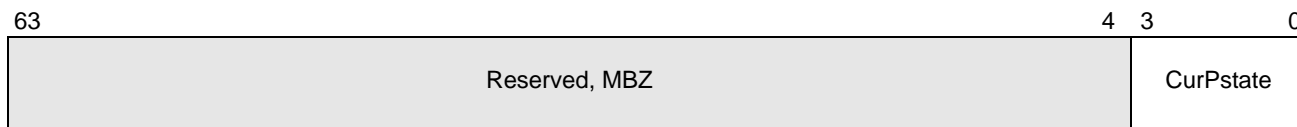

Bits	Mnemonic	Description	R/W
63:4	—	Reserved, MBZ	
3:0	CurPstate	Current P-state	R

**Figure 17-3. P-State Status Register (MSR C001\_0063h)**

*Current P-State (CurPstate)*—Bits 3:0. This field provides the current P-state of the CPU core regardless of the source of the P-state change, including writes to the P-State Control Register: 0 = P-state 0, 1 = P-state 1, etc. The value of this field is updated when the frequency transitions to a new value associated with the P-state. Reset value is implementation specific.

## 17.2 Core Performance Boost

Core performance boost (CPB) dynamically monitors processor activity to create an estimate of power consumption. If the estimated processor consumption is below an internally defined power limit and software has requested P0 on a given core, hardware may transition the core to a frequency and voltage beyond those defined for P0. If the estimated power consumption exceeds the defined power limit, some or all cores are limited to the frequency and voltage defined by P0. CPB ensures that average power consumption over a thermally significant time period remains at or below the defined power limit.

CPB can be disabled using the CPBDis field of the Hardware Configuration Register (HWCR MSR) on the appropriate core. When CPB is disabled, hardware limits the frequency and voltage of the core to those defined by P0.

Support for core performance boost is indicated by CPUID Fn8000\_0007\_EDX[CPB] = 1. See Section 3.3, “Processor Feature Identification,” on page 63 for more information on using the CPUID instruction.

63	25	0	
Reserved, MBZ		Reserved	
Bits	Mnemonic	Description	R/W
63:26	—	Reserved	
25	CPBDis	Core Performance Boost Disable	R/W
24:0	—	Reserved	

**Figure 17-4. Core Performance Boost (MSRC001\_0015h)**

*Core Performance Boost Disable (CpbDis)*—Bit 25. Specifies whether core performance boost is enabled or disabled. 0 = Enabled. 1 = Disabled.

## 17.3 Determining Processor Effective Frequency

The Max Performance Frequency Clock Count (MPERF) and the Actual Performance Frequency Clock Count (APERF) registers constitute the effective frequency interface. This interface provides a means for software to calculate an average, or effective, frequency of a core over a known window of time. This provides software a measure of actual performance rather than forcing software to assume that the current frequency of the core is the frequency of the last P-state requested.

To calculate an effective clock frequency of a given processor core, on that processor do the following:

1. Read both MPERF and APERF and save their initial values.
  - MPERF\_INIT = MPERF and APERF\_INIT = APERF
2. Wait an appropriate amount of time.
3. Read both MPERF and APERF again.
4. Effective frequency =  $\{(APERF - APERF\_INIT) / (MPERF - MPERF\_INIT)\} * P0$  frequency.

The amount of time that elapses between steps 1 and 3 is determined by software. This allows software to define the time window over which the processor frequency is averaged. Software should disable interrupts or any other events that may occur between the read of MPERF and the read of APERF in step 1 and again when the two MSRs are read in step 3. Step 4 provides the equation for the calculation of the effective frequency value. Software determines the P0 frequency using ACPI defined data structures.

The effective frequency interface only counts clock cycles while the core is in the ACPI defined C0 state.

Only the ratio between MPERF and APERF is architecturally defined. Software should not assume any specific definition of the MPERF or APERF registers. If an overflow of either the MPERF or

APERF register occurs between the read of MPERF in step 1 and the read of APERF in step 3, the effective frequency calculated in step 4 is invalid.

Hardware support for the effective frequency interface is indicated by CPUID Fn0000\_0006\_ECX[EffFreq]. See Section 3.3, “Processor Feature Identification,” on page 63 for more information on using the CPUID instruction.

### 17.3.1 Actual Performance Frequency Clock Count (APERF)

Specifies the numerator of the effective frequency ratio.

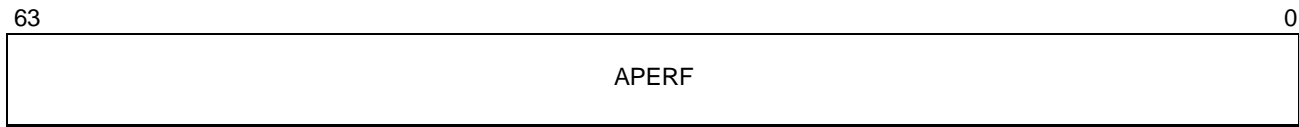

Bits	Mnemonic	Description	Access Type
63:0	APERF	Actual Performance Frequency Clock Count	R/W

**Figure 17-5. Actual Performance Frequency Count (MSR0000\_00E8h)**

### 17.3.2 Maximum Performance Frequency Clock Count (MPERF)

Specifies the denominator of the effective frequency ratio. The value read is scaled by the TSCRatio value (MSR C000\_0104h) for guest reads, but the underlying counters are not affected. Reads in host mode or writes to MPERF are not affected.



Bits	Mnemonic	Description	Access Type
63:0	MPERF	Max Performance Frequency Clock Count	R/W

**Figure 17-6. Max Performance Frequency Count (MSR0000\_00E7h)**

### 17.3.3 MPERF Read-only (MperfReadOnly)

Read-only version of MPERF. The value read is scaled by the TSCRatio value (MSR C000\_0104h) for guest reads.

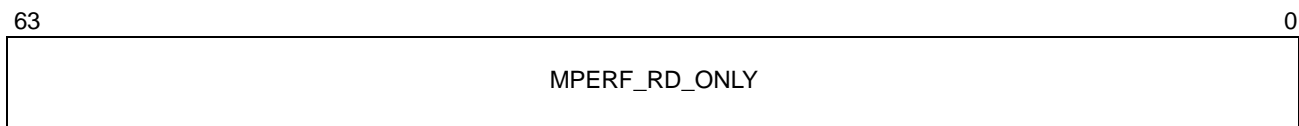

Bits	Mnemonic	Description	Access Type
63:0	MPERF_RD_ONLY	MPERF Read Only	RO

**Figure 17-7. MPERF Read Only (MSR C000\_00E7h)**

## 17.4 Processor Feedback Interface

The Processor Feedback Interface is deprecated. Some processor products may support this feature. To determine support on a given processor, software can test the feature bit CPUID Fn8000\_0007\_EDX[ProcFeedbackInterface]. For more information, consult the *BIOS and Kernel Developer's Guide* applicable to your product.

## 17.5 Processor Core Power Reporting

The processor power reporting interface allows system software to estimate the average power consumed by a processor core over a software-determined time period. Computing the average power involves reading a “core power accumulator” register at the beginning and end of the measurement interval, taking the difference and then dividing by the length of the time interval.

Support for the processor power reporting interface is indicated by CPUID Fn8000\_0007\_EDX[ProcPowerReporting] = 1.

### 17.5.1 Processor Facilities

Estimating core average power involves the use of several processor facilities. Processors that support the processor power reporting interface define the following three facilities:

- CpuSwPwrAcc MSR
- MaxCpuSwPwrAcc MSR
- CpuPwrSampleTimeRatio (CPUID Fn8000\_0007\_ECX)

A fourth facility, available on all processors, is the time-stamp counter (TSC). The TSC is a free-running counter that increments on every processor clock cycle. The current value of this counter is read using the RDTSC instruction.

The contents of the CpuSwPwrAcc register represents the cumulative *energy* consumed by the core. Each hardware-determined sample period (Tsample) a value that represents the energy consumed since the previous sample is added to the contents of this register. Tsample is on the order of a few microseconds. The exact value is immaterial because the CpuPwrSampleTimeRatio register provides the ratio of Tsample to the TSC period.

CpuSwPwrAcc is cleared to zero at power-on and is never reset. Therefore, it is possible for this counter to overflow and roll over to zero. To account for this, the interface provides the MaxCpuSwPwrAcc register. When read, this register provides a value that represents the maximum energy that the CpuSwPwrAcc register can report.

## 17.5.2 Software Algorithm

The following algorithm should be used to calculate the average power consumed by a processor core during the measurement interval  $T_M$ . To obtain a stable average power value,  $T_M$  should be on the order of several milliseconds.

- Determine the value of the ratio of  $T_{\text{sample}}$  to the TSC period ( $\text{CpuPwrSampleTimeRatio}$ ) by executing CPUID Fn8000\_0007. Call this value  $N$ .

$$N = \text{CPUID Fn8000\_0007\_ECX}[31:0].$$

- Read the full range of the cumulative energy value from the register  $\text{MaxCpuSwPwrAcc}$ .

$$J_{\text{max}} = \text{value returned from RDMSR MaxCpuSwPwrAcc.}$$

- At time  $x$ , read  $\text{CpuSwPwrAcc}$  and the TSC

$$J_x = \text{value returned by RDMSR CpuSwPwrAcc}$$

$$T_x = \text{value returned by RDTSC}$$

- At time  $y$ , read  $\text{CpuSwPwrAcc}$  and the TSC again

$$J_y = \text{value returned by RDMSR CpuSwPwrAcc}$$

$$T_y = \text{value returned by RDTSC}$$

Calculate the average power consumption for the processor core over the measurement interval  $T_M = (T_y - T_x)$ .

- If  $(J_y < J_x)$ , rollover has occurred; set  $J_{\text{delta}} = (J_y + J_{\text{max}}) - J_x$   
else  $J_{\text{delta}} = J_y - J_x$
- $\text{PwrCPUave} = N * J_{\text{delta}} / (T_y - T_x)$

Units of result is milliwatts.



## Appendix A MSR Cross-Reference

This appendix lists the MSRs that are defined in the AMD64 architecture. The AMD64 architecture supports some of the same MSRs as previous versions of the x86 architecture and implementations thereof. Where possible, the AMD64 architecture supports the same MSRs, for the same functions, as these previous architectures and implementations.

The first section lists the MSRs according to their MSR address, and it gives a cross reference for additional information. The remaining sections list the MSRs by their functional group. Those sections also give a brief description of the register and specify the register reset value.

Some MSRs are implementation-specific. For information about these MSRs, see the documentation for specific implementations of the AMD64 architecture.

### A.1 MSR Cross-Reference by MSR Address

Table A-1 lists the MSRs in the AMD64 architecture in order of MSR address.

**Table A-1. MSRs of the AMD64 Architecture**

MSR Address	MSR Name	Functional Group	Cross-Reference
0010h	TSC	Performance	"Time-Stamp Counter" on page 369
001Bh	APIC_BASE	System Software	"Local APIC Enable" on page 533
00E7h	MPERF	Performance	"Determining Processor Effective Frequency" on page 562
00E8h	APERF	Performance	"Determining Processor Effective Frequency" on page 562
00FEh	MTRRcap	Memory Typing	"Identifying MTRR Features" on page 196
0174h	SYSENTER_CS	System Software	"SYSENTER and SYSEXIT MSRs" on page 154
0175h	SYSENTER_ESP		
0176h	SYSENTER_EIP		
0179h	MCG_CAP	Machine Check	"Machine-Check Global-Capabilities Register" on page 266
017Ah	MCG_STATUS		"Machine-Check Global-Status Register" on page 267
017Bh	MCG_CTL		"Machine-Check Global-Control Register" on page 268
01D9h	DebugCtl	Software Debug	"Debug-Control MSR (DebugCtl)" on page 353

**Table A-1. MSRs of the AMD64 Architecture (continued)**

MSR Address	MSR Name	Functional Group	Cross-Reference
01DBh	LastBranchFromIP	Software Debug	“Control-Transfer Recording MSRs” on page 355
01DCh	LastBranchToIP		
01DDh	LastIntFromIP		
01DEh	LastIntToIP		
0200h	MTRRphysBase0	Memory Typing	“Variable-Range MTRRs” on page 192
0201h	MTRRphysMask0		
0202h	MTRRphysBase1		
0203h	MTRRphysMask1		
0204h	MTRRphysBase2		
0205h	MTRRphysMask2		
0206h	MTRRphysBase3		
0207h	MTRRphysMask3		
0208h	MTRRphysBase4		
0209h	MTRRphysMask4		
020Ah	MTRRphysBase5		
020Bh	MTRRphysMask5		
020Ch	MTRRphysBase6		
020Dh	MTRRphysMask6		
020Eh	MTRRphysBase7		
020Fh	MTRRphysMask7		
0250h	MTRRfix64K_00000	Memory Typing	“Fixed-Range MTRRs” on page 190
0258h	MTRRfix16K_80000		
0259h	MTRRfix16K_A0000		
0268h	MTRRfix4K_C0000		
0269h	MTRRfix4K_C8000		
026Ah	MTRRfix4K_D0000		
026Bh	MTRRfix4K_D8000		
026Ch	MTRRfix4K_E0000		
026Dh	MTRRfix4K_E8000		
026Eh	MTRRfix4K_F0000		
026Fh	MTRRfix4K_F8000		
0277h	PAT	Memory Typing	“PAT Register” on page 199
02FFh	MTRRdefType		“Default-Range MTRRs” on page 195

Table A-1. MSRs of the AMD64 Architecture (continued)

MSR Address	MSR Name	Functional Group	Cross-Reference
0400h	MC0_CTL	Machine Check	See the documentation for particular implementations of the architecture.
0404h	MC1_CTL		
0408h	MC2_CTL		
040Ch	MC3_CTL		
0410h	MC4_CTL		
0414h	MC5_CTL		
0401h	MC0_STATUS	Machine Check	"Machine-Check Status Registers" on page 271
0405h	MC1_STATUS		
0409h	MC2_STATUS		
040Dh	MC3_STATUS		
0411h	MC4_STATUS		
0415h	MC5_STATUS		
0402h	MC0_ADDR	Machine Check	"Machine-Check Address Registers" on page 274
0406h	MC1_ADDR		
040Ah	MC2_ADDR		
040Eh	MC3_ADDR		
0412h	MC4_ADDR		
0416h	MC5_ADDR		
0403h	MC0_MISC	Machine Check	"Machine-Check Miscellaneous-Error Information Register 0(MCi_MISC0)" on page 274
0407h	MC1_MISC		
040Bh	MC2_MISC		
040Fh	MC3_MISC		
0413h	MC4_MISC		
0417h	MC5_MISC		
C000_0080h	EFER	System Software	"Extended Feature Enable Register (EFER)" on page 55
C000_0081h	STAR	System Software	"SYSCALL and SYSRET MSRs" on page 153
C000_0082h	LSTAR		
C000_0083h	CSTAR		
C000_0084h	SF_MASK		
C000_0100h	FS.Base	System Software	"FS and GS Registers in 64-Bit Mode" on page 72
C000_0101h	GS.Base		
C000_0102h	KernelGSbase	System Software	"SWAPGS Instruction" on page 155
C000_0103h	TSC_AUX	System Software	"RDTSCP Instruction" on page 157

Table A-1. MSRs of the AMD64 Architecture (continued)

MSR Address	MSR Name	Functional Group	Cross-Reference
C000_0408h	MC4_MISC1	Machine Check	“Machine-Check Miscellaneous-Error Information Register 0(MCi_MISC0)” on page 274
C000_0409h	MC4_MISC2		
C000_040Ah	MC4_MISC3		
C001_0000h	PerfEvtSel0	Performance	“Core Performance Event-Select Registers” on page 364
C001_0001h	PerfEvtSel1		
C001_0002h	PerfEvtSel2		
C001_0003h	PerfEvtSel3		
C001_0004h	PerfCtr0	Performance	“Performance Counter MSRs” on page 362
C001_0005h	PerfCtr1		
C001_0006h	PerfCtr2		
C001_0007h	PerfCtr3		
C001_0010h	SYSCFG	Memory Typing	“System Configuration Register (SYSCFG)” on page 59
C001_0016h	IORRBase0	Memory Typing	“IORRs” on page 206
C001_0017h	IORRMask0		
C001_0018h	IORRBase1		
C001_0019h	IORRMask1		
C001_001Ah	TOP_MEM	Memory Typing	“Top of Memory” on page 208
C001_001Dh	TOP_MEM2		
C001_0030h	Processor_Name_String	CPUID Name	See appropriate <i>BIOS and Kernel Developer's Guide</i> for details.
C001_0031h			
C001_0032h			
C001_0033h			
C001_0034h			
C001_0035h			
C001_0056h	SMI_Trigger_IO_Cycle	SMM	See appropriate <i>BIOS and Kernel Developer's Guide</i> for details.
C001_0061h	P-State Current Limit	SMM	“Hardware Performance Monitoring and Control” on page 559
C001_0062h	P-State Control		
C001_0063h	P-State Status		
C001_0074h	CPU_Watchdog_Timer	Machine Check	“CPU Watchdog Timer Register” on page 268
C001_0104h	TSC Ratio	SVM	“TSC Ratio MSR (C000_0104h)” on page 526
C001_0111h	SMBASE	SMM	“SMBASE Register” on page 285
C001_0112h	SMM_ADDR		“SMRAM Protected Area” on page 291
C001_0113h	SMM_MASK		
C001_0114h	VM_CR		SVM

**Table A-1. MSRs of the AMD64 Architecture (continued)**

MSR Address	MSR Name	Functional Group	Cross-Reference
C001_0115h	IGNNE	SVM	“SVM Related MSRs” on page 524
C001_0116h	SMM_CTL	SVM	“SVM Related MSRs” on page 524
C001_0117h	VM_HSAVE_PA	SVM	“SVM Related MSRs” on page 524
C001_0118h	SVM_KEY_MSR	SVM	“SVM-Lock” on page 527
C001_0119h	SMM_KEY_MSR	SMM	“SMM-Lock” on page 528
C001_011Ah	Local_SMI_Status	SMM	See appropriate <i>BIOS and Kernel Developer's Guide</i> for details.
C001_011Bh	Doorbell Register	SVM	“Doorbell Register” on page 521
C001_0140h	OSVW_ID_Length	OSVW	“OS-Visible Workarounds” on page 595
C001_0141h	OSVW Status		

## A.2 System-Software MSRs

Table A-2 lists the MSRs defined for general use by system software in controlling long mode and in allowing fast control transfers between applications and the operating system.

**Table A-2. System-Software MSR Cross-Reference**

MSR Address	MSR Name	Description	Reset Value
0000_001Bh	APIC_BASE	See appropriate <i>BIOS and Kernel Developer's Guide</i> for details.	0000_0000_FEE0_0x00h
C000_0080h	EFER	Contains control bits that enable extended features supported by the processor, including long mode.	0000_0000_0000_0000h
C000_0081h	STAR	In legacy mode, used to specify the target address of a SYSCALL instruction, as well as the CS and SS selectors of the called and returned procedures.	undefined
C000_0082h	LSTAR	In 64-bit mode, used to specify the target RIP of a SYSCALL instruction.	undefined
C000_0083h	CSTAR	In compatibility mode, used to specify the target RIP of a SYSCALL instruction.	undefined
C000_0084h	SF_MASK	SYSCALL Flags Mask	undefined
C000_0100h	FS.Base	Contains the 64-bit base address in the hidden portion of the FS register (the base address from the FS descriptor).	0000_0000_0000_0000h
C000_0101h	GS.Base	Contains the 64-bit base address in the hidden portion of the GS register (the base address from the GS descriptor).	0000_0000_0000_0000h

**Table A-2. System-Software MSR Cross-Reference (continued)**

MSR Address	MSR Name	Description	Reset Value
C000_0102h	KernelGSbase	The SWAPGS instruction exchanges the value in KernelGSbase with the value in GS.base, providing a fast method for system software to load a pointer to system data-structures.	undefined
C000_0103h	TSC_AUX	The RDTSCP instruction copies the value of this MSR into the ECX register.	0000_0000_0000_0000h
C000_0104h	TSC_RATIO	Specifies the TSCRatio value which is used to scale the TSC value read by a Guest.	0000_0001_0000_0000h
0174h	SYSENTER_CS	In legacy mode, used to specify the CS selector of the procedure called by SYSENTER.	undefined
0175h	SYSENTER_ESP	In legacy mode, used to specify the stack pointer for the procedure called by SYSENTER.	undefined
0176h	SYSENTER_EIP	In legacy mode, used to specify the EIP of the procedure called by SYSENTER.	undefined

### A.3 Memory-Typing MSRs

Table A-3 lists the MSRs used to control memory-typing and the page-attribute-table mechanism.

**Table A-3. Memory-Typing MSR Cross-Reference**

MSR Address	MSR Name	Description	Reset Value
00FEh	MTRRcap	A <i>read-only</i> register containing information describing the level of MTRR support provided by the processor.	0000_0000_0000_0508h
0200h	MTRRphysBase0	Specifies the memory-range base address in physical-address space of a variable-range memory region. These registers also specify the memory type used for the memory region.	undefined
0202h	MTRRphysBase1		
0204h	MTRRphysBase2		
0206h	MTRRphysBase3		
0208h	MTRRphysBase4		
020Ah	MTRRphysBase5		
020Ch	MTRRphysBase6		
020Eh	MTRRphysBase7		

Table A-3. Memory-Typing MSR Cross-Reference (continued)

MSR Address	MSR Name	Description	Reset Value
0201h	MTRRphysMask0	Specifies the size of a variable-range memory region.	Valid (bit 11) = 0 All Other Bits Undefined
0203h	MTRRphysMask1		
0205h	MTRRphysMask2		
0207h	MTRRphysMask3		
0209h	MTRRphysMask4		
020Bh	MTRRphysMask5		
020Dh	MTRRphysMask6		
020Fh	MTRRphysMask7		
0250h	MTRRfix64K_00000	Fixed-range MTRRs used to characterize the first 1 Mbyte of physical memory. Each 64-bit register contains eight type fields for characterizing a total of eight memory ranges. <ul style="list-style-type: none"> <li>• MTRRfix64K_n characterizes 64 Kbyte ranges.</li> <li>• MTRRfix16K_n characterizes 16 Kbyte ranges.</li> <li>• MTRRfix4K_n characterizes 4 Kbyte ranges.</li> </ul>	undefined
0258h	MTRRfix16K_80000		
0259h	MTRRfix16K_A0000		
0268h	MTRRfix4K_C0000		
0269h	MTRRfix4K_C8000		
026Ah	MTRRfix4K_D0000		
026Bh	MTRRfix4K_D8000		
026Ch	MTRRfix4K_E0000		
026Dh	MTRRfix4K_E8000		
026Eh	MTRRfix4K_F0000		
026Fh	MTRRfix4K_F8000		
0277h	PAT	Used to extend the page-table entry format, allowing memory-type characterization on a physical-page basis.	0007_0406_0007_0406h
02FFh	MTRRdefType	Sets the default memory-type for physical addresses not within ranges established by fixed-range and variable-range MTRRs.	0000_0000_0000_0000h
C001_0010h	SYSCFG	Contains control bits for enabling and configuring system bus features.	0000_0000_0002_0601h
C001_0016h	IORRBase0	Specifies the memory-range base address in physical-address space of a variable-range I/O region.	undefined
C001_0018h	IORRBase1		
C001_0017h	IORRMask0	Specifies the size of a variable-range I/O region.	Valid (bit 11) = 0 All Other Bits Undefined
C001_0019h	IORRMask1		
C001_001Ah	TOP_MEM	Sets the boundary between system memory and memory-mapped I/O for addresses below 4 Gbytes.	0000_0000_0400_0000h
C001_001Dh	TOP_MEM2	Sets the boundary between system memory and memory-mapped I/O for addresses above 4 Gbytes.	undefined

## A.4 Machine-Check MSRs

Table A-4 lists the MSRs used in support of the machine-check mechanism.

**Table A-4. Machine-Check MSR Cross-Reference**

MSR Address	MSR Name	Description	Reset Value
0179h	MCG_CAP	A read-only register that specifies the machine-check mechanism capabilities supported by the processor.	0000_0000_0000_010xh
017Ah	MCG_STATUS	Provides basic information about the processor state immediately after the occurrence of a machine-check error.	undefined
017Bh	MCG_CTL	Controls global reporting of machine-check errors from various sources.	0000_0000_0000_0000h
0400h	MC0_CTL	Controls error reporting for the data-cache-unit register bank.	0000_0000_0000_0000h
0404h	MC1_CTL	Controls error reporting for the instruction-cache-unit register bank.	0000_0000_0000_0000h
0408h	MC2_CTL	Controls error reporting for the bus-unit register bank.	0000_0000_0000_0000h
040Ch	MC3_CTL	Controls error reporting for the load/store-unit register bank.	0000_0000_0000_0000h
0410h	MC4_CTL	Controls error reporting for the northbridge register bank.	0000_0000_0000_0000h
0414h	MC5_CTL	Controls error reporting for the execution unit register bank.	0000_0000_0000_0000h
0400h + 4i	MCi_CTL	Control for additional error reporting banks, per implementation.	See BKDG
0401h	MC0_STATUS	Status registers for each error-reporting register bank, used to report machine-check error information for the specified register bank.	undefined
0405h	MC1_STATUS		
0409h	MC2_STATUS		
040Dh	MC3_STATUS		
0411h	MC4_STATUS		
0415h	MC5_STATUS		
0402h	MC0_ADDR	Reports the instruction memory-address or data memory-address responsible for the machine-check error for the specified register bank.	undefined
0406h	MC1_ADDR		
040Ah	MC2_ADDR		
040Eh	MC3_ADDR		
0412h	MC4_ADDR		
0416h	MC5_ADDR		



**Table A-4. Machine-Check MSR Cross-Reference (continued)**

MSR Address	MSR Name	Description	Reset Value
0403h	MC0_MISC	Reports miscellaneous information about the machine-check error for the specified register bank.	c00x_xxxx_xx00_0000
0407h	MC1_MISC		
040Bh	MC2_MISC		
040Fh	MC3_MISC		
0413h	MC4_MISC		
0417h	MC5_MISC		c00x_xxxx_0000_0000
C000_0408h	MC4_MISC1		
C000_0409h	MC4_MISC2		
C000_040Ah	MC4_MISC3		
C001_0074h	CPU_Watchdog_Timer	Timer that can cause a machine check error if no operation completes after a specified time period.	0000_0000_0000_0000h

## A.5 Software-Debug MSRs

Table A-5 lists the MSRs used in support of the software-debug architecture.

**Table A-5. Software-Debug MSR Cross-Reference**

MSR Address	MSR Name	Description	Reset Value
01D9h	DebugCtl	Provides debug controls for control-transfer recording and control-transfer single stepping, and external-breakpoint reporting and trace messages.	0000_0000_0000_0000h
01DBh	LastBranchFromIP	During control-transfer recording, this register is loaded with the segment offset of the control-transfer source.	undefined
01DCh	LastBranchToIP	During control-transfer recording, this register is loaded with the segment offset of the control-transfer target.	undefined
01DDh	LastIntFromIP	When an interrupt occurs during control-transfer recording, this register is loaded with LastBranchFromIP before LastBranchFromIP is updated.	undefined
01DEh	LastIntToIP	When an interrupt occurs during control-transfer recording, this register is loaded with LastBranchToIP before LastBranchToIP is updated.	undefined

## A.6 Performance-Monitoring MSRs

Table A-6 lists the MSRs used in support of performance monitoring, including the time-stamp counter.

**Table A-6. Performance-Monitoring MSR Cross-Reference**

MSR Address	MSR Name	Description	Reset Value
0010h	TSC	Counts processor-clock cycles. It is incremented once for each processor-clock cycle.	0000_0000_0000_0000h
C001_0000h	PerfEvtSel0	For the corresponding performance counter, this register specifies the events counted, and controls other aspects of counter operation.	0000_0000_0000_0000h
C001_0001h	PerfEvtSel1		
C001_0002h	PerfEvtSel2		
C001_0003h	PerfEvtSel3		
C001_0004h	PerfCtr0	Used to count specific processor events, or the duration of events, as specified by the corresponding PerfEvtSel $n$ register.	undefined
C001_0005h	PerfCtr1		
C001_0006h	PerfCtr2		
C001_0007h	PerfCtr3		
C001_0200h	PerfEvtSel0	These MSR addresses are aliases for the base set of performance event-select registers PerfEvtSel[3:0].	0000_0000_0000_0000h
C001_0202h	PerfEvtSel1		
C001_0204h	PerfEvtSel2		
C001_0206h	PerfEvtSel3		
C001_0208h	PerfEvtSel4	Extended core performance event-select registers. Support for these MSRs is indicated by CPUID Fn8000_0001_ECX[PerfCtrExtCore] = 1.	
C001_020Ah	PerfEvtSel5		
C001_0201h	PerfCtr0	These MSR addresses are aliases for the base set of performance-monitoring counter registers PerfCtr[3:0].	undefined
C001_0203h	PerfCtr1		
C001_0205h	PerfCtr2		
C001_0207h	PerfCtr3		
C001_0209h	PerfCtr4	Extended core performance counter registers. Support for these MSRs is indicated by CPUID Fn8000_0001_ECX[PerfCtrExtCore] = 1.	
C001_020Bh	PerfCtr5		
C001_0230h	L2I_PerfEvtSel0	Specifies the L2 cache events to be counted and controls other aspects of counter operation. Support for these MSRs is indicated by CPUID Fn8000_0001_ECX[PerfCtrExtL2I] = 1.	0000_0000_0000_0000h
C001_0232h	L2I_PerfEvtSel1		
C001_0234h	L2I_PerfEvtSel2		
C001_0236h	L2I_PerfEvtSel3		
C001_0231h	L2I_PerfCtr0	Counts specific L2 cache events as specified by the corresponding L2I_PerfEvtSel $n$ Register. Support for these MSRs is indicated by CPUID Fn8000_0001_ECX[PerfCtrExtL2I] = 1.	undefined
C001_0233h	L2I_PerfCtr1		
C001_0235h	L2I_PerfCtr2		
C001_0237h	L2I_PerfCtr3		

**Table A-6. Performance-Monitoring MSR Cross-Reference (continued)**

MSR Address	MSR Name	Description	Reset Value
C001_0240h	NB_PerfEvtSel0	Specifies northbridge events to be counted and controls other aspects of counter operation. Support for these MSRs is indicated by CPUID Fn8000_0001_ECX[PerfCtrExtNB] = 1.	0000_0000_0000_0000h
C001_0242h	NB_PerfEvtSel1		
C001_0244h	NB_PerfEvtSel2		
C001_0246h	NB_PerfEvtSel3		
C001_0241h	NB_PerfCtr0	Counts specific northbridge events as specified by the corresponding NB_PerfEvtSel $n$ Register. Support for these MSRs is indicated by CPUID Fn8000_0001_ECX[PerfCtrExtNB] = 1.	undefined
C001_0243h	NB_PerfCtr1		
C001_0245h	NB_PerfCtr2		
C001_0247h	NB_PerfCtr3		

## A.7 Secure Virtual Machine MSRs

Table A-7 lists the MSRs used in support of SVM functions.

**Table A-7. Secure Virtual Machine MSR Cross-Reference**

MSR Address	MSR Name	Description	Reset Value
C001_0114h	VM_CR	Controls certain global aspects of SVM.	undefined
C001_0115h	IGNNE	Sets the state of the processor-internal IGNNE signal.	
C001_0116h	SMM_CTL	Provides software control over SMM signals.	
C001_0117h	VM_HSAVE_PA	Holds the physical address of a block of memory where VMRUN saves host state, and from which #VMEXIT reloads host state.	
C001_0118h	SVM_KEY	Creates a password-protected mechanism to clear VM_CR.LOCK.	
C001_0119h	SMM_KEY	Creates a password-protected mechanism to clear SmmLock.	
C001_011Bh	Doorbell Register	Sends a doorbell signal to the specified physical APIC.	

## A.8 System Management Mode MSR's

Table A-8 lists the MSR's used in support of SMM functions.

**Table A-8. System Management Mode MSR Cross-Reference**

MSR Address	MSR Name	Description	Reset Value
C001_0111h	SMBASE	Contains the SMRAM base address.	0000_0000_0003_0000h
C001_0112h	SMM_ADDR	Contains the base address of protected memory for the SMM Handler.	0000_0000_0000_0000h
C001_0113h	SMM_MASK	Contains a mask which determines the size of the protected area for the SMM handler.	0000_0000_0000_0000h
C001_011Ah	Local_SMI_Status	Contains status associated with SMI sources local to the CPU core. See the appropriate <i>BIOS and Kernel Developer's Guide</i> for details.	0000_0000_0000_0000h
C001_0056h	SMI_Trigger_IO_Cycle	Specifies an IO cycle that may be generated when a local SMI trigger event occurs. See the appropriate <i>BIOS and Kernel Developer's Guide</i> for details.	0000_0000_0000_0000h

## A.9 CPUID Name MSR Cross-Reference

Table A-9 lists the MSR's used to support CPUID namestring.

**Table A-9. CPUID Namestring MSR's**

MSR Address	MSR Name	Description	Reset Value
C001_0030h	Processor_Name_String	See appropriate <i>BIOS and Kernel Developer's Guide</i> and <i>Processor Revision Guide</i> .	
C001_0031h			
C001_0032h			
C001_0033h			
C001_0034h			
C001_0035h			

## Appendix B Layout of VMCB

The VMCB is divided into two areas—the first one contains various control bits including the intercept vector and the second one contains saved guest state.

Table B-1 describes the layout of the control area of the VMCB, which starts at offset zero within the VMCB page. The control area is padded to a size of 1024 bytes. All unused bytes must be zero, as they are reserved for future expansion. It is recommended that software “bzero” any newly allocated VMCB.

**Table B-1. VMCB Layout, Control Area**

Byte Offset	Bit(s)	Function
000h	15:0	Intercept reads of CR0–15, respectively.
	31:16	Intercept writes of CR0–15, respectively.
004h	15:0	Intercept reads of DR0–15, respectively.
	31:16	Intercept writes of DR0–15, respectively.
008h	31:0	Intercept exception vectors 0–31, respectively.
00Ch	0	Intercept INTR (physical maskable interrupt).
	1	Intercept NMI.
	2	Intercept SMI.
	3	Intercept INIT.
	4	Intercept VINTR (virtual maskable interrupt).
	5	Intercept CR0 writes that change bits other than CR0.TS or CR0.MP.
	6	Intercept reads of IDTR.
	7	Intercept reads of GDTR.
	8	Intercept reads of LDTR.
	9	Intercept reads of TR.
	10	Intercept writes of IDTR.
	11	Intercept writes of GDTR.
	12	Intercept writes of LDTR.
	13	Intercept writes of TR.
	14	Intercept RDTSC instruction.
15	Intercept RDPIC instruction.	

**Table B-1. VMCB Layout, Control Area (continued)**

Byte Offset	Bit(s)	Function
00Ch (continued)	16	Intercept PUSHF instruction.
	17	Intercept POPF instruction.
	18	Intercept CUID instruction.
	19	Intercept RSM instruction.
	20	Intercept IRET instruction.
	21	Intercept INT $n$ instruction.
	22	Intercept INVD instruction.
	23	Intercept PAUSE instruction.
	24	Intercept HLT instruction.
	25	Intercept INVLPG instruction.
	26	Intercept INVLPGA instruction.
	27	IOIO_PROT—Intercept IN/OUT accesses to selected ports.
	28	MSR_PROT—intercept RDMSR or WRMSR accesses to selected MSRs.
	29	Intercept task switches.
30	FERR_FREEZE: intercept processor “freezing” during legacy FERR handling.	
31	Intercept shutdown events.	
010h	0	Intercept VMRUN instruction.
	1	Intercept VMSCALL instruction.
	2	Intercept VMLoad instruction.
	3	Intercept VMSAVE instruction.
	4	Intercept STGI instruction.
	5	Intercept CLGI instruction.
	6	Intercept SKINIT instruction.
	7	Intercept RDTSCP instruction.
	8	Intercept ICEBP instruction.
	9	Intercept WBINVD instruction.
	10	Intercept MONITOR/MONITORX instruction.
	11	Intercept MWAIT/MWAITX instruction unconditionally.
	12	Intercept MWAIT/MWAITX instruction if monitor hardware is armed.
	13	Intercept XSETBV instruction.
31:14	RESERVED, SBZ	
014h–03Bh	RESERVED, SBZ	
03Ch	15:0	PAUSE Filter Threshold

Table B-1. VMCB Layout, Control Area (continued)

Byte Offset	Bit(s)	Function
03Eh	15:0	PAUSE Filter Count
040h	63:0	IOPM_BASE_PA—Physical base address of IOPM (bits 11:0 are ignored.)
048h	63:0	MSRPM_BASE_PA—Physical base address of MSRPM (bits 11:0 are ignored.)
050h	63:0	TSC_OFFSET—To be added in RDTSC and RDTSCP
058h	31:0	Guest ASID
	39:32	TLB_CONTROL 00h—Do nothing. 01h—Flush entire TLB (all entries, all ASIDs) on VMRUN. Should only be used by legacy hypervisors. 03h—Flush this guest’s TLB entries. 07h—Flush this guest’s non-global TLB entries. <i>NOTE: All other encodings are reserved.</i>
	63:40	RESERVED, SBZ
060h	7:0	V_TPR—The virtual TPR for the guest. Bits 3:0 are used for a 4-bit virtual TPR value; bits 7:4 are SBZ. <i>NOTE: This value is written back to the VMCB at #VMEXIT.</i>
	8	V_IRQ—If nonzero, virtual INTR is pending. <i>NOTE: This value is written back to the VMCB at #VMEXIT. This field is ignored on VMRUN when AVIC is enabled.</i>
	15:9	RESERVED, SBZ
	19:16	V_INTR_PRIO—Priority for virtual interrupt <i>NOTE: This field is ignored on VMRUN when AVIC is enabled.</i>
	20	V_IGN_TPR—If nonzero, the current virtual interrupt ignores the (virtual) TPR. <i>NOTE: This field is ignored on VMRUN when AVIC is enabled.</i>
	23:21	RESERVED, SBZ
	24	V_INTR_MASKING—Virtualize masking of INTR interrupts (see “Virtualizing APIC.TPR” on page 478).
	30:25	Reserved, SBZ
	31	AVIC Enable
	39:32	V_INTR_VECTOR—Vector to use for this interrupt. <i>NOTE: This field is ignored on VMRUN when AVIC is enabled.</i>
63:40	RESERVED, SBZ	

Table B-1. VMCB Layout, Control Area (continued)

Byte Offset	Bit(s)	Function
068h	0	INTERRUPT_SHADOW—Guest is in an interrupt shadow (see “Interrupt Shadows” on page 479). <i>Note: This value is written back to the VMCB at #VMEXIT.</i>
	63:1	RESERVED, SBZ
070h	63:0	EXITCODE
078h	63:0	EXITINFO1
080h	63:0	EXITINFO2
088h	63:0	EXITINTINFO
090h	0	NP_ENABLE—Enable nested paging.
	63:1	RESERVED, SBZ
098h	63:52	RESERVED, SBZ
	51:0	AVIC APIC_BAR <i>NOTE: Address must be 4-Kbyte aligned.</i>
098h–0A7h	Reserved, SBZ	
0A8h	63:0	EVENTINJ—Event injection (see “Event Injection” on page 476 for details.)
0B0h	63:0	N_CR3—Nested page table CR3 to use for nested paging
0B8h	0	LBR_VIRTUALIZATION_ENABLE 0—Do nothing. 1—Enable LBR virtualization hardware acceleration.
	63:1	Reserved, SBZ
0C0h	31:0	VMCB Clean Bits
	63:32	Reserved, SBZ
0C8h	63:0	nRIP—Next sequential instruction pointer
0D0h	7:0	Number of bytes fetched
	127:8	Guest instruction bytes
0E0h	63:52	RESERVED, SBZ
	51:0	AVIC APIC_BACKING_PAGE Pointer <i>NOTE: Address must be 4-Kbyte aligned.</i>
0E8h–0EFh	Reserved, SBZ	
0F0h	63:52	RESERVED, SBZ
	51:12	AVIC LOGICAL_TABLE Pointer <i>NOTE: Address must be 4-Kbyte aligned.</i>



**Table B-1. VMCB Layout, Control Area (continued)**

Byte Offset	Bit(s)	Function
0F8h	63:52	RESERVED, SBZ
	51:12	AVIC PHYSICAL_TABLE Pointer[51:12] <i>NOTE: Address must be 4-Kbyte aligned.</i>
	11:8	RESERVED, SBZ
	7:0	AVIC_PHYSICAL_MAX_INDEX
All other fields up to 3FFh	RESERVED, SBZ	

The state-save area within the VMCB starts at offset 400h into the VMCB page; Table B-2 describes the fields within the state-save area; note that the table lists offsets *relative to the state-save area* (not the VMCB as a whole).

**Table B-2. VMCB Layout, State Save Area**

Offset	Size	Contents	Notes
000h	word	ES	selector
002h	word		attrib
004h	dword		limit
008h	qword		base
010h	word	CS	selector
012h	word		attrib
014h	dword		limit
018h	qword		base
020h	word	SS	selector
022h	word		attrib
024h	dword		limit
028h	qword		base
030h	word	DS	selector
032h	word		attrib
034h	dword		limit
038h	qword		base
040h	word	FS	selector
042h	word		attrib
044h	dword		limit
048h	qword		base
050h	word	GS	selector
052h	word		attrib
054h	dword		limit
058h	qword		base

Table B-2. VMCB Layout, State Save Area (continued)

Offset	Size	Contents	Notes	
060h	word	GDTR	selector	reserved
062h	word		attrib	reserved
064h	dword		limit	Only lower 16 bits are implemented.
068h	qword		base	
070h	word	LDTR	selector	
072h	word		attrib	
074h	dword		limit	
078h	qword		base	
080h	word	IDTR	selector	reserved
082h	word		attrib	reserved
084h	dword		limit	Only lower 16 bits are implemented.
088h	qword		base	
090h	word	TR	selector	
092h	word		attrib	
094h	dword		limit	
098h	qword		base	
0A0h–0CAh		RESERVED		
0CBh	byte	CPL	If the guest is real-mode then the CPL is forced to 0; if the guest is virtual-mode then the CPL is forced to 3.	
0CCh	dword	RESERVED		
0D0h	qword	EFER		
0D8h–147h		RESERVED		
148h	qword	CR4		
150h	qword	CR3		
158h	qword	CR0		
160h	qword	DR7		
168h	qword	DR6		
170h	qword	RFLAGS		
178h	qword	RIP		
180h–1D7h		RESERVED		
1D8h	qword	RSP		
1E0h–1F7h		RESERVED		
1F8h	qword	RAX		
200h	qword	STAR		
208h	qword	LSTAR		
210h	qword	CSTAR		

**Table B-2. VMCB Layout, State Save Area (continued)**

Offset	Size	Contents	Notes
218h	qword	SFMASK	
220h	qword	KernelGsBase	
228h	qword	SYSENTER_CS	
230h	qword	SYSENTER_ESP	
238h	qword	SYSENTER_EIP	
240h	qword	CR2	
248h–267h		RESERVED	
268h	qword	G_PAT	Guest PAT—only used if nested paging enabled.
270h	qword	DBGCTL	Guest DebugCtl MSR—only used if hardware acceleration of LBR virtualization is supported and enabled by setting the LBR_VIRTUALIZATION_ENABLE bit of the VMCB control area.
278h	qword	BR_FROM	Guest LastBranchFromIP MSR—only used if hardware acceleration of LBR virtualization is supported and enabled.
280h	qword	BR_TO	Guest LastBranchToIP MSR—only used if hardware acceleration of LBR virtualization is supported and enabled.
288h	qword	LASTEXCPFROM	Guest LastIntFromIP MSR—Only used if hardware acceleration of LBR virtualization is supported and enabled.
290h	qword	LASTEXCPTO	Guest LastIntToIP MSR—Only used if hardware acceleration of LBR virtualization is supported and enabled.
298h to end of VMCB		RESERVED	



## Appendix C SVM Intercept Exit Codes

When the VMRUN instruction exits (back to the host), an exit/reason code is stored in the EXIT-CODE field in the VMCB. The exit codes are defined in Table C-1. Intercept exit codes 0h–8Dh equal the bit position of the corresponding flag in the VMCB’s intercept vector.

**Table C-1. SVM Intercept Codes**

Code	Name	Cause
0h–Fh	VMEXIT_CR[0–15]_READ	read of CR 0 through 15, respectively
10h–1Fh	VMEXIT_CR[0–15]_WRITE	write of CR 0 through 15, respectively
20h–2Fh	VMEXIT_DR[0–15]_READ	read of DR 0 through 15, respectively
30h–3Fh	VMEXIT_DR[0–15]_WRITE	write of DR 0 through 15, respectively
40h–5Fh	VMEXIT_EXCP[0–31]	exception vector 0–31, respectively
60h	VMEXIT_INTR	physical INTR (maskable interrupt)
61h	VMEXIT_NMI	physical NMI
62h	VMEXIT_SMI	physical SMI (the EXITINFO1 field provides more information)
63h	VMEXIT_INIT	physical INIT
64h	VMEXIT_VINTR	virtual INTR
65h	VMEXIT_CR0_SEL_WRITE	write of CR0 that changed any bits other than CR0.TS or CR0.MP
66h	VMEXIT_IDTR_READ	read of IDTR
67h	VMEXIT_GDTR_READ	read of GDTR
68h	VMEXIT_LDTR_READ	read of LDTR
69h	VMEXIT_TR_READ	read of TR
6Ah	VMEXIT_IDTR_WRITE	write of IDTR
6Bh	VMEXIT_GDTR_WRITE	write of GDTR
6Ch	VMEXIT_LDTR_WRITE	write of LDTR
6Dh	VMEXIT_TR_WRITE	write of TR
6Eh	VMEXIT_RDTSC	RDTSC instruction
6Fh	VMEXIT_RDPMC	RDPMC instruction
70h	VMEXIT_PUSHF	PUSHF instruction
71h	VMEXIT_POPF	POPF instruction
72h	VMEXIT_CPUID	CPUID instruction
73h	VMEXIT_RSM	RSM instruction
74h	VMEXIT_IRET	IRET instruction
75h	VMEXIT_SWINT	software interrupt (INT $n$ instructions)
76h	VMEXIT_INVDP	INVD instruction
77h	VMEXIT_PAUSE	PAUSE instruction
78h	VMEXIT_HLT	HLT instruction

Table C-1. SVM Intercept Codes (continued)

Code	Name	Cause
79h	VMEXIT_INVLPG	INVLPG instructions
7Ah	VMEXIT_INVLPGA	INVLPGA instruction
7Bh	VMEXIT_IOIO	IN or OUT accessing protected port (the EXITINFO1 field provides more information)
7Ch	VMEXIT_MSR	RDMSR or WRMSR access to protected MSR
7Dh	VMEXIT_TASK_SWITCH	task switch
7Eh	VMEXIT_FERR_FREEZE	FP legacy handling enabled, and processor is frozen in an x87/mmx instruction waiting for an interrupt
7Fh	VMEXIT_SHUTDOWN	Shutdown
80h	VMEXIT_VMRUN	VMRUN instruction
81h	VMEXIT_VMMCALL	VMMCALL instruction
82h	VMEXIT_VMLOAD	VMLOAD instruction
83h	VMEXIT_VMSAVE	VMSAVE instruction
84h	VMEXIT_STGI	STGI instruction
85h	VMEXIT_CLGI	CLGI instruction
86h	VMEXIT_SKINIT	SKINIT instruction
87h	VMEXIT_RDTSCP	RDTSQP instruction
88h	VMEXIT_ICEBP	ICEBP instruction
89h	VMEXIT_WBINVD	WBINVD instruction
8Ah	VMEXIT_MONITOR	MONITOR or MONITORX instruction
8Bh	VMEXIT_MWAIT	MWAIT or MWAITX instruction
8Ch	VMEXIT_MWAIT_CONDITIONAL	MWAIT or MWAITX instruction, if monitor hardware is armed.
8Dh	VMEXIT_XSETBV	XSETBV instruction
400h	VMEXIT_NPF	Nested paging: host-level page fault occurred (EXITINFO1 contains fault error code; EXITINFO2 contains the guest physical address causing the fault.)
401h	AVIC_INCOMPLETE_IPI	AVIC—Virtual IPI delivery not completed. See "AVIC IPI Delivery Not Completed" for EXITINFO1–2 definitions.
402h	AVIC_NOACCEL	AVIC—Attempted access by guest to vAPIC register not handled by AVIC hardware. See "AVIC Access to un-accelerated vAPIC register" for EXITINFO1–2 definitions.
–1	VMEXIT_INVALID	Invalid guest state in VMCB

## Appendix D SMM Containerization

To minimally participate in SMM activity, the VMM can implement simple containerization. This appendix provides example pseudocode to perform this simple containerization. VMMs that do not trust SMM code should implement secure containerization, which requires further extension of the code provided here.

### D.1 SMM Containerization Pseudocode

This code emulates transitions to and from SMM:

- The process of entering SMM mode as a result of a system management interrupt (SMI)
- The RSM instruction, which returns the processor from SMM.

A hypervisor that containerizes SMM must set the SMM intercept bit in all guest VMCBs. When the hypervisor encounters a #VMEXIT(SMI), it should then emulate SMM entry and execute the SMM handler by means of VMRUN with the RSM intercept bit set. When the RSM instruction is intercepted, the hypervisor should emulate the RSM instruction and then resume normal execution.

In this code, the hypervisor sets up the `smm_vmcb` from scratch and assigns it the supplied address space identifier (ASID).

This example code sets up a container VMCB for the SMM handler and copies appropriate state information into the SMM save area. After calling `emulate_smm()`, the hypervisor should repeatedly VMRUN the SMM handler VMCB until the hypervisor encounters a #VMEXIT(RSM). Finally, the hypervisor should call `emulate_rsm()`.

```
//emulate_smm( ):
// Inputs:
//   smm_vmcb:  the _virtual address_ of a VMCB that will be configured
//               as an SMM container
//   asid:      the asid to use for the SMM handler; the hypervisor should
//               ensure that no TLB entries for this ASID are present in the TLB
//   smm_regs:  an array of 64-bit values that will be filled with the
//               GPRs (except RSP and RAX) for the SMM handler
//   guest_vmcb: the _virtual address_ of the VMCB of the guest
//               that was running when the intercepted SMI occurred
//   guest_regs: an array of 64-bit values that contains the GPRs (except RSP
//               and RAX) for the guest that was running when the intercepted
//               SMI occurred

void
emulate_smm(VMCB *smm_vmcb, uint32 asid, uint64 smm_regs[16],
            VMCB *guest_vmcb, uint64 guest_regs[16])
{
    setup_smm_container(*smm_vmcb, asid, smm_regs, *guest_vmcb, guest_regs)
```

```

//Enter SMM mode:
wrmsr(SMM_CTL_MSR, ENTER+DISMISS+SMI_CYCLE)
setup_smm_save_state(*guest_vmcb, guest_regs)

do { VMRUN(smm_vmcb) } until we see #VMEXIT(RSM).
    Shadow EFER reads and writes to protect the SVME bit.

//Emulate RSM:
copy_smm_save_to_guest_vmcb(guest_vmcb, guest_regs)
//Leave SMM mode:
wrmsr(SMM_CTL_MSR, EXIT+RSM_CYCLE)
}

void
setup_smm_container(VMCB &smm_vmcb, uint32 asid, uint64 smm_regs[16],
                   VMCB &g_vmcb, uint64 guest_regs[16])
{
    clear smm_vmcb to all zeros
    set intercepts in smm_vmcb:
        RSM
        VMRUN
        MSR
    smm_vmcb.msrpm = (physical address of msr protection map with
                     efer read and efer write set)
    // Note that the hypervisor should shadow the SVME bit of EFER and
    // return EFER.SVME=0 on reads of EFER.
    //
    // Note also that the IOPM (unused in this example code) and MSRPM for the SMM
    // container can be statically set up and reused on subsequent SMM entries,
    // and can be shared between multiple cores' SMM container VMCBs. Each core
    // must have a separate VMCB for the SMM container, but those cores' VMCBs may
    // be statically or dynamically allocated.

    smm_vmcb.asid = asid

    smmbase = rdmsr(smmbase_msr) // Note: smmbase is a 32 bit value

    Set up the smm handler's segment information: {Selector, Attrib, Limit, Base}

    smm_vmcb.CS = {(smmbase & 0x00ffff00) >> 4, 0x089B, 0xffff_ffff, smmbase}
    smm_vmcb.{ES, SS, DS, FS, GS} = {0x0000, 0x0893, 0xffff_ffff, 0x0000_0000}
    smm_vmcb.GDTR = {unused, unused, g_vmcb.gdtr_limit, g_vmcb.gdtr_base}
    smm_vmcb.LDTR = (copy all from g_vmcb.LDTR)
    smm_vmcb.IDTR = {unused, unused, g_vmcb.idtr_limit, g_vmcb.idtr_base}
    smm_vmcb.TR = (copy all from g_vmcb.TR)

    smm_vmcb.CPL = 0
    smm_vmcb.EFER = 0x1000 (SVME = 1)

```



```

smm_vmcb.CR4 = 0
smm_vmcb.DR7 = 0x0000_0400
smm_vmcb.RFLAGS = 0x0000_0002
smm_vmcb.RIP = 0x0000_8000

```

Copy the following values from `g_vmcb` to `smm_vmcb`

```

CR3
DR6
RSP
RAX
STAR
LSTAR
CSTAR
SFMASK
KERNELGSBASE
SYSENTER_CS
SYSENTER_ESP
SYSENTER_EIP
CR2
CR0: clear bits 0, 2, 3, 31

```

```

copy 14 guest GPRs from guest_regs (all except RAX, RSP) to smm_regs
}

```

void

```

setup_smm_save_state(struct VMCB &g_vmcb, uint64 guest_regs[16])
{
    smmbase = rdmsr(smmbase_msr) // Note: smmbase is a 32 bit value
    smmsave_physical_addr = smmbase + 0xfe00
    // smmsave is the physical address of the SMM save area;
    // the hypervisor will need to map this into its virtual memory space.
    smmsave = virtual_to_physical_map(smmsave_physical_addr)

```

Copy the following values from `g_vmcb` to `smmsave`:

```

all defined portions of ES, CS, SS, DS, FS, GS, GDTR, LDTR, IDTR, TR
(all bytes of each 16-byte segment save area)

```

```

CPL
EFER
CR4
CR3
CR0
DR7
DR6
RFLAGS
RIP
RSP
RAX

```

```

copy 14 guest GPRs (other than RAX and RSP) from guest_regs

```

to GPR entries in smmsave

```

iorestart_dword[31:0] = g_vmcb.exitinfo1[63:32]
if ((iorestart_dword & IO_RESTART_VALID) != 0)
{
    Copy iorestart_dword to smmsave.iorestart_dword,
        masking out address size bits
    Copy g_vmcb.exitinfo2 to smmsave.iorestart_rip

    uint64 *guest_indexreg // Point to the index register in the guest context
                            // that is changed by the string instruction...
    uint64 *smm_indexreg  // ...similarly, for the smm save area
    if (iorestart_dword & IO_RESTART_IN != 0) {
        guest_indexreg = &guest_regs[RDI] // type=IN, indexreg=RDI
        smm_indexreg = &smmsave.iorestart_rdi
        smmsave.iorestart_rsi = guest_regs[RSI]
    } else {
        guest_indexreg = &guest_regs[RSI] // type=OUT, indexreg=RSI
        smm_indexreg = &smmsave.iorestart_rsi
        smmsave.iorestart_rdi = guest_regs[RDI]
    }
}

// Reconstruct the IORestart values
if (iorestart_dword & IO_RESTART_STR != 0)
{
    uint64 mask
    uint64 ecxfix

    operand_size = (iorestart_dword >> 4) & 0x7

    address_size = (iorestart_dword >> 7) & 0x7
    if (address_size == 0) // Some SVM implementations do not provide
                          // these bits; we must decode on those CPUs
        address_size = decode_io_size(guest_vmcb)

    mask = (1<<address_size) - 1
    if (g->RFLAGS D-bit is set)
        operand_size = -operand_size

    if (iorestart_dword & IO_RESTART_RIP != 0)
        ecxfix = 1
    else ecxfix = 0

    *smm_indexreg = *guest_indexreg & ~mask | (*guest_indexreg -
                                                operand_size) & mask
    smmsave.iorestart_rcx = mask & (guest_regs[RCX] + ecxfix)
} else { // not string
    *smm_indexreg = *guest_indexreg
    smmsave.iorestart_rcx = guest_regs[RCX]
}
} else { // iorestart isn't valid: Put the same values into the restart values.

```

```

    smmsave.iorestart_dword = 0
    smmsave.iorestart_rip = g.rip
    smmsave.iorestart_rcx = guest_regs[RCX]
    smmsave.iorestart_rsi = guest_regs[RSI]
    smmsave.iorestart_rdi= guest_regs[RDI]
}

smmsave.iorestart = 0
smmsave.hltrestart = 0
smmsave.nmimask = 0
smmsave.smm_revision = 0x30064
smmsave.smm_base = smmbase
}

void
copy_smm_save_to_guest_vmcb(struct VMCB &g_vmcb, uint64 guest_regs[16])
{
    smmbase = rdmsr(smmbase_msr) // Note: smmbase is a 32 bit value
    smmsave_physical_addr = smmbase + 0xfe00
    // smmsave is the physical address of the SMM save area;
    // the hypervisor will need to map this into its virtual memory space.
    smmsave = virtual_to_physical_map(smmsave_physical_addr)

    Copy the following values from smmsave to g_vmcb
    all defined portions of ES, CS, SS, DS, FS, GS, GDTR, LDTR, IDTR, TR
    CPL
    EFER
    CR4
    CR3
    CR0
    DR7
    DR6
    RFLAGS
    RSP
    RAX

    Copy the other 14 GPRs from smmsave into guest_regs.

    If smmsave.iorestart is set, copy RDI,
    RSI, RCX from the smmsave.iorestart_{RDI, RSI, RCX} fields
        instead of the regular {RDI, RSI, RCX} fields.

    if (smmsave.iorestart is zero and smmsave.iorestart_dword is valid)
    {
        modify g_vmcb.DR6:
            clear g_vmcb.DR6[3:0] and copy BRP bits from
                smmsave.iorestart_dword[15:12] into g_vmcb.DR6[3:0]
            // this preserves AMD's behavior that dr6[3:0] is not sticky,
            // but the other bits are sticky
            g_vmcb.DR6.BS |= smmsave.iorestart_dword.TF
            if any bit of smmsave.iorestart_dword.{BRP[3:0], TF} is nonzero,

```

```

        we have a pending #DB exception,
        so set up a #DB event injection for the guest.
    }

    if (smmsave.iorestart is set) {
        set g_vmcb.RIP = smmsave.iorestart_rip
    } else if (smmsave.hltrestart is set) {
        // (In the event that the guest is allowed to execute HLT and
        // the SMM code wants to use the auto-halt restart function,
        // we need to re-execute the HLT instruction in the guest context.
        // Even if the HLT has prefixes (all of which would be ignored),
        // we know that RIP-1 is the F4 opcode itself.)

        Subtract 1 from the guest RIP under a mask that masks out bits
            above the current default address size:

        mask = (1 << current_address_size) - 1
        g_vmcb.RIP = mask & (g_vmcb.RIP-1)
    } else {
        set g_vmcb.RIP = smmsave.RIP
    }
// Note that it is undefined to have both iorestart and hltrestart set at
// the same time.

// Perform the RSM consistency checks listed in volume 3 of the
// AMD64 Architecture Programmer's manual, except the check that
// disallows CR0.PG = 1 when CR0.PE = 0. Note that the expected
// value for the SMM revision field is 0x0003_0064. If any of the
// checks fail, the native RSM instruction would have caused a
// processor shutdown (which commonly results in a reboot
// triggered by the chipset). The hypervisor may wish to destroy
// the guest or cause its own shutdown.
}

```

### D.1.1 Converting Simple Containerization into Secure Containerization

To convert this simple containerization example into secure containerization, the hypervisor must limit the SMM handler's access to I/O ports, MSRs, and memory. Based on security policy decisions, the hypervisor should set appropriate bits in the I/O Protection Map and the MSR Protection map and emulate any accesses the SMM handler makes to those protected resources. The hypervisor should run the SMM handler in paged real mode, with a page table that appropriately limits memory accessible to SMM code. Additionally, the hypervisor may wish to conceal some or all of the contents of a guest's general purpose and floating-point registers from the SMM handler.

## Appendix E OS-Visible Workarounds

Operating system software may provide a workaround for a hardware erratum. These operating system-visible workarounds are provisional and should be removed or disabled when the erratum is corrected in a subsequent hardware release.

The OS-Visible Workaround (OSVW) architecture provides a means by which operating system software may determine the status of a known erratum for the hardware on which the software is running. Support for the OSVW mechanism is indicated by CPUID Fn8000\_0001\_ECX[OSVW] = 1.

See Section 3.3, "Processor Feature Identification," on page 63 for information on using the CPUID instruction.

Each hardware erratum is assigned a unique OSVW ID number. OSVW ID numbers start at 0 and are assigned sequentially up to the most recently identified erratum which is assigned the number  $m-1$ . The OSVW mechanism encodes the status of each erratum for a given hardware system in a bit vector of length  $m$  accessed through OSVW MSR 1–N. The state of bit  $n$  of the vector indicates the status of the erratum with the OSVW ID number  $n$ . The OSVW ID number for the erratum and the bit position within the erratum status bit vector, once assigned, are global across all AMD processors; the OSVW ID and bit position will not be re-used.

The OSVW MSRs are defined as follows:

- OSVW MSR0 contains the *OSVW\_ID\_Length* field, used to indicate the total number of valid OSVW ID bits ( $m$ ). The format of this MSR is shown in Figure E-1 below.
- OSVW MSR 1 and following contain the erratum status bit vector of length  $m$ . Each bit  $n$  of this vector encodes the status of erratum  $n$  (OSVW ID =  $n$ ). The format of these MSRs is shown in Figure E-2 on page 596.

The bank of OSVW MSRs is located at address C001\_0140h, starting with OSVW MSR0.

The OSVW MSRs should be treated as read-only registers for the OS. The OS should never write into these registers. Hardware allows platform firmware writes to these registers.



Bits	Mnemonic	Description	R/W <sup>1</sup>
63:16	Reserved		
15:0	OSVW_ID_Length	Total length of the status vector OSVW_E in bits.	R/W

Note 1: MSR should be treated as read-only by operating system software.

**Figure E-1. OSVW MSR0: OSVW\_ID\_Length**

*OSVW\_ID\_Length*—Bits [15:0]. The number of valid bits in the OSVW erratum status vector *OSVW\_E*. If a specific erratum has an OSVW ID that is greater than or equal to the *OSVW\_ID\_Length*, the erratum is unknown to the latest release. Otherwise, the erratum status bit in the appropriate OSVW MSR can be checked to see if a workaround is required.

The erratum status bit vector (*OSVW\_E*) is accessed through OSVW MSR 1 and following. For MSR *N*, the 64-bit MSR holds erratum status bits  $(N-1)*64+63:(N-1)*64$ . To access the erratum status for OSVW ID number *n* (*E[n]* in the diagram), read MSR *N*, where  $N = n/64 + 1$ , and test bit *i*, where  $i = n$  modulo 64.

Figure E-2 below gives the format of the OSVW MSRs 1–*N*.



Bit	Mnemonic	Description	R/W <sup>1</sup>
<i>i</i>	OSVW_E[ <i>n</i> ]	OS-visible workaround status bit <i>n</i>	R/W

Note 1: MSR should be treated as read-only by operating system software.

**Figure E-2. OSVW MSRs 1–*N*: OSVW Erratum Status Registers**

*OS-Visible Workaround Erratum Status (OSVW\_E[*n*])*—Bits 63:0. Each bit indicates whether platform hardware is affected by OS-visible erratum *n* and whether the OS needs to apply a workaround.

For the status bit:

1 = Hardware contains the erratum; an OS software workaround is required.

0 = Hardware has corrected the erratum; an OS software workaround is unnecessary. If one is installed, it must be disabled.

The location of an OSVW ID status bit within a bank of OSVW MSRs is determined as follows:

- MSR address = OSVW\_MSR0 + 1 + floor (OSVW\_ID /64)
- Bit offset in MSR = OSVW\_ID modulo 64

If a specific erratum has an OSVW\_ID that is greater than or equal to the OSVW\_ID\_LENGTH, hardware does not know about the erratum and the processor model must be used to determine whether the workaround must be applied.

OSVW MSR bits beyond the end of the OSVW\_E bit vector are reserved.

## E.1 Erratum Process Overview

Following is an overview of the AMD erratum process:

1. When an OS-visible erratum is discovered, AMD assigns a unique OSVW ID to the erratum and publishes to OS vendors the starting range of affected processor models and suggested workarounds.
2. AMD works with platform firmware vendors and OEMs in parallel to develop a firmware update to add the new erratum status bit to the OSVW\_E erratum status bit vector for affected silicon revisions to report the new OSVW ID as requiring a workaround. The OSVW\_ID\_Length field in OSVW MSR0 is incremented by one.
3. OS vendors schedule the workaround into their release schedules and eventually release it.
4. The OS detection logic for the workaround first checks whether the processor OSVW MSRs 1–N record the erratum by comparing the OSVW ID of the erratum with the OSVW\_ID\_Length field in OSVW MSR0.
5. If the erratum OSVW ID is greater than or equal to the OSVW\_ID\_Length, the current firmware does not know about this erratum. In this case, the OS software compares the processor model ID with the starting model ID that AMD supplied with the erratum to determine if the workaround should be applied.
6. If the erratum OSVW ID is less than the OSVW\_ID\_Length, the firmware is aware of the erratum. In this case, the OS uses the state of the associated OSVW\_E status bit to conditionally apply the workaround. If the associated status bit is set, the workaround is applied.
7. Once AMD fixes the erratum in a future release, updated firmware ensures that the OSVW\_E status bit associated with the erratum is cleared. When OS workaround detection logic runs on the new hardware, it will see that the bit corresponding to the OSVW ID is cleared and not apply the OS workaround for that erratum.





# Index

## Symbols

#AC	227
#BP	218
#BR	219
#D	226, 229
#DB	217
#DE	217
#DF	220
#GP	224
#I	226, 229
#IA	226
#IS	226
#MC	228
#MF	226
#NM	220
#NP	223
#O	227, 229
#OF	219
#P	227, 229
#PF	225
#SS	223
#SX	503
#TS	222
#U	227, 229
#UD	219
#VMEXIT	448, 449
#XF	229
#Z	227, 229

## Numerics

16-bit mode	xxxvi
1-Gbyte page	135
32-bit mode	xxxvi
64-bit media instructions	
causing #MF exception	306
initializing	432, 433
MMX registers	305
saving state	308
64-bit mode	xxxvi, 13

## A

A bit	82, 84, 139
A20 Masking	498
abort	212
AC bit	54
access checking	485
accessed (A)	
code segment	82

data segment	84
page-translation tables	139
address space identifier (ASID)	473
address-breakpoint registers (DR0-DR3)	349
addressing	
RIP-relative	xl
address-size prefix	31
ADDRV bit	273
Advanced Programmable Interrupt Controller (APIC)	531
alignment check (rFLAGS.AC)	54, 227
alignment mask (CR0.AM)	45, 227
alignment-check exception (#AC)	45, 54, 227
AM bit	45
AP startup sequence	503
APIC	531
base address	534
enable	534
error interrupts	543
internal error	532
registers	534
timer interrupt	540
version register	536
APIC.TPR	478
APIC.TPR virtualization	447
Application Processors (APs)	502
Arbitration	550
architecture differences	23
ARPL instruction	159
ASID	473
attributes	78
available to software (AVL)	
descriptor	81
page-translation tables	140
AVL bit	81, 140

## B

base address	75, 78, 80, 123, 131, 138
benign exception	220
BIST	427
bootstrap CPU core (BSC)	534
bootstrap processor (BSP)	430, 502
BOUND instruction	219
bound-range exception (#BR)	219
BR_FROM	484
BR_TO	484
branches	32
breakpoint	
determining cause	357

on address match .....	348, 358	default-operand size (D) .....	83
on any instruction .....	348	ignored fields in 64-bit mode .....	88
on I/O .....	358	long bit (L).....	26, 89
on instruction .....	357	long mode .....	88
on task switch .....	348, 360	readable (R) .....	82
setting address .....	355	type field.....	82
specifying address-match length .....	355	coherency, cache .....	163
breakpoint exception (#BP) .....	218	Combining Memory Types and MTRRs.....	495
breakpoints.....	355	commit.....	xxxvi
built-in self test (BIST) .....	427	commit, instruction results .....	164
<b>C</b>		compatibility mode .....	xxxvi, 13
C bit .....	82	config space accesses .....	486
cache		conforming (C), code segment .....	82
control mechanisms .....	182	consistency checks, long mode.....	437
control precedence.....	184	containerized SMM code .....	482
enabling .....	431	contributory exception.....	220
index .....	181	control registers .....	29, 41
invalidate .....	185	control transfer .....	100
line.....	163	See also call gate and interrupt.	
offset .....	181	call gate .....	104
organization .....	179	direct .....	100
self-modifying code .....	181	far, conforming code segment.....	102
set .....	180	far, nonconforming code segment.....	100
tag .....	181	interrupt to higher privilege .....	240
way .....	180	interrupt to same privilege .....	239
writeback and invalidate.....	185	parameters.....	108
cache disable (CD) bit.....	45, 182	stack switch.....	108
cache disable (CD), memory type.....	172	control-transfer recording MSRs .....	355
cache-coherency protocol .....	169	coprocessor-segment-overflow exception.....	221
losing coherency.....	171	count field .....	94
CALL		CPL .....	96, 449
See call gate and control transfer.		definition .....	96
call gate .....	86, 104	in call gate protection.....	105
count field.....	88	in data segment protection .....	97, 278
count field, long mode .....	94	in interrupt to higher privilege .....	241
descriptor, long mode.....	32	in protecting conforming CS .....	102
jump through.....	106	in protecting nonconforming CS .....	101
parameters .....	108	in stack segment protection.....	99
privilege checks.....	105	privileged instructions.....	149
stack switch .....	108	SYSCALL, SYSRET assumptions .....	153
stack switch, long mode .....	33, 109	CPU watchdog timer register .....	268
canonical address form.....	4, 130	CPUID.....	55, 63, 155, 460
CD bit.....	45, 182	nested paging .....	498
CD memory type .....	172	CR0 .....	42, 449
CLFLUSH .....	184, 485	alignment mask (AM) .....	45, 227
CLGI .....	461, 474	cache disable (CD).....	45, 182
CLI instruction .....	156	emulate coprocessor (EM).....	44
clock multiplier .....	428	emulate coprocessor (EM) bit .....	303
CLTS .....	156, 459	extension type (ET).....	44
code segment.....	26, 71, 82	monitor coprocessor (MP) .....	43
64-bit mode.....	72	not write-through (NW).....	45, 182
accessed (A).....	82	numeric error (NE) .....	44, 227
conforming (C).....	82	paging enable (PG) .....	45, 120
		protection enable (PE).....	43, 66, 73

task switched (TS).....	44, 156
write protect (WP).....	44
CR1.....	51
CR2.....	45, 226, 449
CR3.....	25, 45, 46, 123, 130, 335, 449, 491
non-PAE paging.....	123
PAE paging.....	46, 123
PAE paging, long mode.....	130
page-level cache disable (PCD).....	123, 131
page-level write-through (PWT).....	123, 131
table-base address.....	123, 131
CR4.....	47, 449
debugging extensions (DE).....	49
machine-check enable (MCE).....	49, 228
OS #XF support (OSXMMEXCPT).....	229, 303, 304
OS FXSAVE/FXRSTOR support (OSFXSR).....	303
page-global enable (PGE).....	50, 142
page-size extensions (PSE).....	49, 121, 125
performance counter enable (PCE).....	50, 156, 363
physical-address extensions (PAE).....	49, 121, 130
protected-mode virtual interrupts (PVI).....	49
time-stamp disable (TSD).....	49, 157, 370
virtual-8086 mode extensions (VME).....	48, 254
CR5–CR7.....	51
CR8.....	51, 235
CR9–CR15.....	51
CS register.....	71, 449
selector.....	448
CSTAR register.....	153, 569, 571
<b>D</b>	
D bit.....	83, 89, 139
D/B bit.....	81, 85
Data Limit Checks.....	114
Data limit checks.....	114
data prefetch, cache.....	184
data segment.....	26, 71, 83
64-bit mode.....	72
accessed (A).....	84
default operand size (D).....	85
expand down (E).....	84
FS and GS.....	27, 72
ignored fields in 64-bit mode.....	89
long mode.....	89
privilege checks.....	97
type field.....	84
writable (W).....	84
DAZ bit.....	323
DBGCTL.....	484
DE bit.....	49
DE exception.....	226, 229
debug.....	21, 502
See breakpoint and single-step.	
debug exception (#DB).....	54, 217, 357
debug registers.....	29, 348
address-breakpoint registers (DR0–DR3).....	349
control-transfer recording MSRs.....	355
debug-control MSR (DebugCtl).....	353
debug-control register (DR7).....	351
reserved (DR4, DR5).....	349
debug-control MSR (DebugCtl).....	353
debug-control register (DR7).....	351
DebugCtl register.....	567, 575
debugging extensions (CR4.DE).....	49
DEC instruction.....	34
default operand size.....	
B bit, stack segment.....	85
D bit, code segment.....	83
D bit, data segment.....	85, 112
D/B bit, descriptor.....	81
with expand down.....	113
denormalized-operand exception (DE).....	226, 229
denormals-are-zeros (DAZ) mode.....	323
descriptor.....	67, 80
available to software (AVL).....	81
code segment.....	26
data segment.....	26
default operand size (D/B).....	81
DPL.....	81, 97, 340
gate.....	27
granularity (G).....	81
long mode.....	88
present (P).....	81, 340
S field.....	81, 340
segment base.....	80
segment limit.....	80
system segment.....	27
TSS.....	330
type field.....	81, 340
descriptor table.....	67, 73
global-descriptor table (GDT).....	69
interrupt-descriptor table (IDT).....	37
local-descriptor table (LDT).....	69
descriptor-table registers.....	26, 68
64-bit mode.....	94
GDTR.....	74
IDTR.....	79
LDTR.....	76
DEV base address registers.....	489
DEV caching.....	485
DEV capability block.....	486
DEV register access.....	487
DEV_BASE_HI/LO registers.....	487
DEV_CAP register.....	488
DEV_CR register.....	488
DEV_DATA.....	486
DEV_HDR.....	486
DEV_MAP Registers.....	490

DEV_OP.....	486, 487	See rIP.	
DEVBASE registers.....	484	eIP register .....	xlili
device exclusion vector (DEV) .....	484	EIPV bit .....	267
device ID .....	484	EM bit.....	44, 432
device-not-available exception (#NM).....	43, 44, 220	emulate coprocessor (CR0.EM).....	44
differences (architectural) .....	23	EN bit .....	273
direct referencing.....	xxxvi	enabling SVM .....	447
dirty (D), page-translation tables .....	139	endian byte-ordering .....	xliv
displacement .....	31	End-of-Interrupt Register (EOI) .....	556
displacements .....	xxxvii	environment .....	309
divide-by-zero-error exception (#DE).....	217	error code	
double quadword .....	xxxvii	page fault .....	231
double-fault exception (#DF).....	220	selector .....	231
doubleword .....	xxxvii	ES register.....	72, 449
DP field .....	323	ES.SEL .....	449
DPL.....	97	ESP	
data segment, 64-bit mode.....	90	See rSP.	
definition .....	97	ET bit.....	44
in call gate protection.....	105	event handler, definition .....	211
in data segment protection.....	97, 278	event injection .....	476
in interrupt stack switch .....	240	EVENTINJ.....	476
in interrupt to higher privilege .....	241	exception handler, definition .....	211
in protecting conforming CS.....	102	exception intercept	
in protecting nonconforming CS .....	101	#AC.....	466
in stack segment protection .....	99	#BP .....	465
in stack switching .....	108	#BR .....	465
DPL field .....	81, 340	#DB .....	465
DR0-DR3 registers .....	349	#DE .....	464
DR4, DR5 registers.....	349	#DF .....	465
DR6 register.....	350, 449	#GP .....	466
DR7 register.....	449	#MC .....	467
DS field .....	323	#MF .....	466
DS register .....	71, 72, 449	#NM .....	465
DS.SEL.....	449	#NP .....	466
<b>E</b>		#OF .....	465
E bit.....	84	#PF.....	466
eAX-eSP register .....	xlili	#SS.....	466
EFER register.....	29, 55, 449, 569, 571	#TS .....	466
fast FXSAVE/FXRSTOR (FFXSR).....	57	#UD .....	465
long mode active (LMA).....	56, 436	#XF .....	467
long mode enable (LME) .....	56, 436	vector 2.....	465
no-execute enable (NXE) .....	57	vector 9.....	466
system-call extension (SCE).....	56	Exception Intercepts .....	464
EFER.SVME.....	447	exceptions .....	xxxvii
effective address .....	2, 25	abort .....	212
effective address size.....	xxxvii	benign.....	220
effective memory type.....	197	contributory.....	220
effective operand size.....	xxxvii	definition of .....	211
EFLAGS		definition of vector .....	214
See rFLAGS.		differences in long mode .....	36
eFLAGS register.....	xlili	error code, page fault .....	231
EIP		error code, selector.....	231
		fault.....	212
		floating-point priorities .....	233

imprecise ..... 212  
 maskable SSE floating point..... 213  
 maskable x87 floating point..... 213  
 masking during stack switches..... 213  
 precise ..... 211  
 priorities ..... 232  
 trap..... 212  
 while in SMM ..... 294  
 exclusive state, MOESI ..... 169  
 EXITINFO1 ..... 462  
 expand down (E)  
   data segment ..... 84  
   stack segment..... 84, 113  
 extended family field ..... 431  
 Extended Interrupts ..... 543  
 extended model field ..... 431  
 extended save area ..... 316  
 extended state management ..... 315  
 extensible state management..... 315  
 extension type (CR0.ET) ..... 44

**F**

family field ..... 431  
 far control transfer ..... 100  
 far return ..... 33, 111  
 fast FXSAVE/FXRSTOR ..... 57  
 fault ..... 212  
 FCW register ..... 307, 309, 322  
 feature identification ..... 63  
 FENCE ..... 166  
 FFXSR bit..... 57  
 fill, cache-line..... 163  
 first instruction ..... 430  
 flat segmentation ..... 6, 9, 67  
 FLDENV, FSTENV instructions ..... 313  
 floating-point exception pending (#MF) ..... 226  
   caused by 64-bit media instructions..... 306  
 floating-point exception priorities ..... 233  
 flush ..... xxxvii  
 FOP register ..... 322  
 FPR registers ..... 307, 309  
 FS and GS ..... 27, 72  
 FS register..... 72  
 FS.Base register..... 569, 571  
 FSAVE, FRSTOR instructions ..... 309  
 FSW register ..... 305, 307, 309, 322  
 FTW register ..... 306, 307, 309, 322  
 FXSAVE, FXRSTOR instructions ..... 36, 50, 313  
   32-bit memory image..... 322  
   64-bit memory image..... 321  
   x87 tag word format ..... 323

**G**

G bit ..... 81, 140  
 gate descriptors ..... 27  
   call gate ..... 86  
   DPL..... 97  
   ignored fields in long mode ..... 92  
   illegal types in long mode..... 92  
   interrupt gate ..... 86  
   long mode ..... 92, 94  
   redefined types in long mode ..... 92  
   target-segment offset ..... 87  
   target-segment selector..... 87  
   task gate..... 86  
   trap gate ..... 86  
 GDT ..... 73  
 GDTR ..... 74, 449, 459  
 general detect fault ..... 217, 359  
 general-protection exception (#GP) ..... 224  
 general-purpose registers (GPRs) ..... 28  
 GIF ..... 474  
 global descriptor table (GDT) ..... 69, 73  
   base address, 64-bit mode..... 75  
   first entry ..... 74  
   limit check, long mode ..... 75  
 global descriptor-table register (GDTR) ..... 74  
   base address ..... 75  
   limit..... 75  
   loading..... 158  
   storing ..... 158  
 global interrupt flag (GIF)..... 474  
 global page (G), page-translation tables ..... 140  
 global pages..... 50, 142  
 granularity (G), descriptor..... 81, 112  
 GS register ..... 72  
 GS.Base register ..... 569, 571  
 guest mode ..... 445  
 Guest page tables (gPT)..... 491

**H**

halt ..... 159  
 Hardware errata ..... 595  
 HLT ..... 159, 460  
 host ..... 445  
 hypervisor ..... 445

**I**

I/O interrupts ..... 532  
 I/O Permissions Map ..... 461  
 I/O privilege level field (rFLAGS.IOPL) ..... 53  
 I/O space accesses ..... 486  
 I/O, memory-mapped ..... 203  
 I/O-permission bitmap

in 32-bit TSS.....	335	INTERRUPT_SHADOW .....	449
in 64-bit TSS.....	338	interrupt-descriptor table (IDT)	
I/O-permission bitmap (IOPB).....	336	index .....	211, 238, 248
ICEBP .....	461	protected mode .....	237
ID bit .....	55	real-address mode .....	235
IDT.....	78	interrupt-redirecton bitmap .....	336
IDTR .....	79, 449, 459	interrupts	
IE exception .....	226, 229	definition of external .....	211
IF bit.....	53, 258	definition of software .....	211
IGN .....	xxxviii	definition of vector .....	214
illegal state .....	448	differences in long mode .....	36
immediate operand.....	31	external .....	230
imprecise exceptions and interrupts .....	212	external maskable .....	213
IN/OUT .....	462	external nonmaskable.....	213
INC instruction.....	34	external-interrupt priorities .....	234
indirect .....	xxxviii	imprecise .....	212
inexact-result exception.....	227, 229	long mode summary.....	247
INIT .....	480	precise .....	211
initialization .....	427	priorities .....	232
initialization (INIT)		returning from 64-bit mode.....	253
processor state.....	428	returns .....	244
In-Service Register .....	552	software .....	230
instructions (system-management) .....	149	stack alignment, long mode .....	250
INT3 instruction .....	218, 360	stack pointer push, long mode.....	249
integer bit.....	324	stack switch, long mode .....	37, 250
intercept.....	447	to higher privilege.....	240
Ferr_Freeze.....	468, 469	to same privilege .....	239
shutdown .....	469	while in SMM .....	294
task switch.....	468	interrupt-stack table (IST).....	37, 93, 251
Intercept Exit Codes.....	587	in 64-bit TSS .....	338
Interprocessor interrupt (IPI).....	502, 545	interrupt-vector table .....	235
INIT .....	502	INTn .....	460
Startup .....	502	INTn instruction .....	230, 360
Interrupt Control.....	533	INTO instruction.....	219
interrupt descriptor table (IDT) .....	78	invalid arithmetic-operand exception .....	226
limit check, long mode.....	79	invalid state, MOESI .....	169
interrupt descriptor-table register (IDTR).....	79	invalidate page.....	474
loading .....	158	invalid-opcode exception (#UD).....	34, 219
storing .....	158	invalid-operation exception (IE) .....	226, 229
interrupt flag (rFLAGS.IF) .....	53, 156	invalid-TSS exception (#TS).....	222
interrupt gate .....	86, 247	INVD.....	160, 185, 460
IST field .....	93	INVLPG .....	460
interrupt handler, definition .....	211	INVLPG instruction .....	142, 160
interrupt intercept .....	467	INVLPGA.....	460, 474
INIT .....	468	IOPB.....	335, 336
INTR.....	467	IOPL.....	462
NMI .....	467	IOPL field .....	53, 245
SMI.....	467	IOPL-sensitive instruction .....	254
virtual.....	468	IOPM.....	461
interrupt redirection .....	245, 256	IOPM_BASE_PA .....	461
Interrupt Request Register .....	551	IORRBase registers .....	206, 570, 573
interrupt shadows.....	479	IORRMask registers .....	207, 573
		IORRs, variable-range .....	206

IOSPE .....	486	LMSLE .....	57
IRET .....	460	LMSW .....	156, 459
less privilege .....	244	load ordering .....	184
long mode .....	37, 253	Local APIC .....	533
same privilege .....	244	ID .....	535
IST field .....	93	interrupt masking .....	480, 556
<b>J</b>		local descriptor table (LDT) .....	69, 75
J bit .....	325	base address, 64-bit mode .....	78
jump		limit check, long mode .....	78
See call gate and control transfer.		local descriptor-table register (LDTR) .....	76
<b>K</b>		attributes .....	78
KernelGSbase register .....	155, 569, 572	base address .....	78
<b>L</b>		hidden portion .....	76
L bit .....	89	LDT selector .....	77
L1 data cache .....	163	limit .....	78
L1 instruction cache .....	163	loading .....	158
L2 cache .....	163	storing .....	158
L2I_PerfEvtSel registers .....	368	Local Interrupts .....	538
LAR instruction .....	158	locality .....	141
last branch record virtualization .....	483	logging	
LastBranchFromIP .....	483	unauthorized access .....	490
LastBranchFromIP register .....	568, 575	logical address .....	2
LastBranchToIP .....	483	long attribute (L)	
LastBranchToIP register .....	568, 575	code segment .....	89
LASTEXCPFROM .....	484	effect on D bit .....	89
LASTEXCPTO .....	484	long mode .....	xxxviii, 12, 23
LastIntFromIP .....	483	activating .....	437
LastIntFromIP register .....	568, 575	consistency checks .....	437
LastIntToIP .....	483	differences from legacy mode .....	39
LastIntToIP register .....	568, 575	enabling .....	436
LDT .....	75	enabling versus activating .....	436
selector field .....	335	GDT requirements .....	435
LDTR .....	76, 459	IDT requirements .....	435
Legacy Interrupts .....	532	leaving .....	439
legacy mode .....	xxxviii, 14, 23	page translation-table requirements .....	436
legacy PAE mode .....	497	relocating descriptor tables .....	438
legacy x86 .....	xxxviii	relocating page tables .....	438
LFENCE .....	165	TSS requirements .....	436
LFENCE instruction .....	184	use of CS.L and CS.D .....	437
LGDT .....	158, 459	long mode active (EFER.LMA) .....	56, 436
LIDT .....	158, 459	long mode enable (EFER.LME) .....	56, 436
limit .....	75, 78, 80, 330	LSB .....	xxxix
linear address .....	3	lsb .....	xxxix
Link field .....	335	LSTAR register .....	153, 569, 571
LINT0 .....	542	LTR .....	158, 459
LINT1 .....	542	<b>M</b>	
LLDT .....	158, 459	M bit .....	325
LMA bit .....	56	machine check	
LME bit .....	56	error codes .....	274
		error-reporting address register (MCi_ADDR) .....	274
		error-reporting control register (MCi_CTL) .....	271
		error-reporting miscellaneous register (MCi_MISC) .....	274

error-reporting register banks.....	269	memory-mapped I/O	
error-reporting status register (MCi_STATUS).....	271	directing reads and writes to .....	204, 208
global-capabilities register (MCG_CAP).....	266	memory-type range register (MTRR).....	29
global-control register (MCG_CTL).....	268	combined with PAT .....	202
global-status register (MCG_STATUS) .....	267	effect of paging cache controls.....	197
initialization .....	277	effects with large page sizes.....	198
machine check registers.....	265	fixed range .....	190
machine-check enable (CR4.MCE) .....	49, 228	identifying features .....	196
machine-check exception (#MC).....	228	initial value .....	431
mask .....	xxxix	IORRBase.....	206
masking		IORRMask.....	207
definition of interrupt.....	211	MTRRcap .....	196
MBZ.....	xxxix	MTRRdefType .....	195
MCA error code field .....	272	MTRRfix16K.....	191
MCE bit.....	49	MTRRfix4K.....	191
MCG_CAP register.....	266, 567, 574	MTRRfix64K.....	191
MCG_CTL register.....	268, 567, 574	MTRRphysBase .....	192
MCG_CTL Register Present bit .....	267	MTRRphysMask .....	193
MCG_STATUS register.....	267, 567, 574	overlapping ranges.....	198
MCi Bank Count field.....	267	type field, default.....	188
MCi_ADDR registers.....	274, 569, 574	type field, extended.....	204
MCi_CTL registers .....	271, 569, 574	variable range.....	192
MCi_MISC registers .....	569, 575	variable range size and alignment.....	194
MCi_STATUS registers.....	271, 569, 574	MFENCE instruction.....	184
MCIP bit .....	267	MISCV bit.....	273
Media Extension Control and Status Register (MXCSR)...	304	MMX registers .....	305
memory .....	161	model field .....	431
memory addressing		model-specific error code field.....	272
canonical address form.....	4	model-specific registers (MSRs).....	29, 58, 156
effective address.....	2	control-transfer recording .....	355
linear address .....	3	debug extensions .....	62
logical address.....	2	debug-control MSR (DebugCtl) .....	353
near pointers .....	2	initializing .....	433
physical address .....	3	machine check.....	62, 265
real address .....	10	memory typing .....	61, 189
RIP-relative address.....	31	PAT .....	199
segment offset .....	2	performance monitoring .....	62, 363
virtual address .....	3	SYSCFG.....	59
memory consistency.....	496	system linkage.....	61, 153
memory management.....	5	time-stamp counter .....	62, 369
memory serialization.....	184	TOP_MEM .....	208
memory system .....	161	TOP_MEM2 .....	208
memory type .....	172	modes .....	11
determining effective .....	197	64-bit.....	13
uncacheable (UC).....	172	compatibility .....	xxxvi, 13
write-combining (WC).....	172	legacy .....	xxxviii, 14
write-combining plus (WC+).....	173	long .....	xxxviii, 12
write-protect (WP).....	173	protected .....	xl, 14
memory-access ordering		real .....	xl, 4, 14
description .....	164	virtual-8086.....	xlii, 14
read ordering.....	164	modified state, MOESI.....	169
write ordering.....	165	MOESI .....	169
		moffset.....	xxxix
		monitor coprocessor (CR0.MP).....	43
		MOV CRn instruction .....	155



MOV DRn instruction.....	156
MOV TO CR0.....	459
MOV TO/FROM CR0 .....	459
MOV TO/FROM CRn .....	459
MOV TO/FROM DRn .....	459
MOVSXD instruction .....	34
MP bit.....	43, 432
MSB .....	xxxix
msb .....	xxxix
MSR.....	xliv
MSR permissions map (MSRPM) .....	463
MSR_PROT.....	464
MSRs .....	58
MTRRcap register .....	196, 567, 572
MTRRdefType register.....	195, 568, 573
MTRRfix16K_n registers .....	191
MTRRfix4K_n registers .....	191
MTRRfix64K_n registers .....	191, 568, 573
MtrrFixDramEn bit .....	60, 204
MtrrFixDramModEn bit .....	60, 204
MTRRphysBasen registers .....	192, 568, 572
MTRRphysMaskn registers .....	193, 573
MTRRs.....	189, 496
MtrTom2En bit.....	60, 210
MtrVarDramEn bit.....	60, 210
multiprocessor issues .....	485
MXCSR register .....	305
field.....	323
MXCSR_MASK field.....	323
<b>N</b>	
NB_PerfEvtSel registers.....	367
NE bit.....	44, 432
near branch	
operand size, 64-bit mode .....	32
near control transfer .....	100
near pointers.....	2
near return.....	111
Nested page tables (hPT) .....	491
nested paging .....	491
nested task (rFLAGS.NT).....	53, 345
nestedtable walk .....	493
NEXT_RIP .....	448
NMI .....	218
NMI support.....	481
no-execute (NX)	
page-translation tables, bit in .....	140
nonmaskable interrupt exception (NMI) .....	218
while in SMM .....	294
non-PAE paging.....	122
CR3 format .....	123
NOP instruction.....	34
not write-through (CR0.NW) .....	45, 182
NP_ENABLE .....	493
NT bit .....	53
null selector .....	70
64-bit mode far return .....	112
interrupt return from 64-bit mode.....	253
long mode interrupts .....	250, 252
long mode stack switch .....	110
numeric error (CR0.NE) .....	44, 227
NW bit.....	45
NX bit.....	140
NXE bit.....	57
<b>O</b>	
octword.....	xxxix
OE exception.....	227, 229
offset.....	xxxix, 87
operand-size prefix.....	30
operating modes.....	11
OS FXSAVE/FXRSTOR support (CR4.OSFXSR)....	303
OS unmasked exception support (CR4.OSXMMEXCPT)	
229, 303, 304	
OSFXSR bit .....	50
OS-visible workarounds (OSVW) .....	595
OSVW ID .....	595
OSVW status.....	597
OSVW_ID_Length .....	597
OSXMMEXCPT bit.....	50
OVER bit .....	273
overflow.....	xxxix
overflow exception (#OF).....	219
overflow exception (OE) .....	227, 229
owned state, MOESI .....	169
<b>P</b>	
P bit .....	81, 138, 340
packed.....	xl
PAE .....	449
PAE bit.....	49, 121
PAE paging .....	25, 122
CR3 format .....	46, 123
CR3 format, long mode.....	130
legacy mode .....	126
long mode .....	131
page directory .....	122
page size (PS).....	122, 125, 127
page directory pointer.....	122, 127
page faults	
guest level.....	494
page size (PS), page-translation tables .....	139
page splintering .....	497
page table .....	122

page translation .....	117	PAT register .....	199, 568, 573
page-attribute table (PAT) .....	199	PAUSE .....	460
combined with MTRR .....	202	PCC bit .....	273
effect on memory access .....	201	PCD bit .....	123, 131, 139
identifying support .....	201	PCE bit .....	50
indexing .....	200	PDE .....	122
page-translation tables, bit in .....	140	PDPE .....	122, 449, 497
Paged Real Mode .....	476	PE bit .....	43
page-fault exception (#PF) .....	138, 225	PE exception .....	227, 229
page-fault virtual address .....	226	PerfCtr registers .....	362, 570, 576, 577
page-global enable (CR4.PGE) .....	50, 142	PerfEvtSel registers .....	362, 570, 576
page-level cache disable (PCD) .....	183	performance counter .....	156
CR3, bit in .....	123	performance counter enable (CR4.PCE) .....	50, 156, 363
page-translation tables, bit in .....	139	Performance Monitor Counter Interrupts .....	542
page-level write-through (PWT) .....	183	performance optimization .....	22, 362
CR3, bit in .....	123	performance-monitoring counters	
page-translation tables, bit in .....	139	L2I_PerfEvtSeln .....	368
page-map level-4 .....	130	NB_PerfEvtSeln .....	367
page-size extensions (CR4.PSE) .....	25, 26, 49, 121, 125	overflow .....	369
40-bit physical address support .....	121, 126	PerfCtrn .....	363
unsupported in long mode .....	121	PerfEvtSeln .....	364
page-translation cache .....	141	starting and stopping .....	369
page-translation tables .....	25	PG bit .....	45, 120
accessed (A) .....	139	PGE bit .....	50
available to software (AVL) .....	140	physical address .....	3, 24
dirty (D) .....	139	as index into cache .....	181
global page (G) .....	140	physical memory .....	4
hierarchy .....	119	physical-address extensions (CR4.PAE) .....	25, 49, 121, 130
no-execute .....	140	activating long mode .....	121, 437
page directory entry (PDE) .....	122	See also PAE paging.	
page size (PS) .....	139	POP instruction .....	156
page table entry (PTE) .....	122	POPF .....	460
page-attribute table (PAT) .....	140	precise exceptions and interrupts .....	211
page-directory pointer entry (PDPE) .....	25, 122, 127	precision exception (PE) .....	227, 229
page-level cache disable (PCD) .....	139	PREFETCH instruction .....	184
page-level write-through (PWT) .....	139	present (P)	
page-map level-4 entry (PML4E) .....	25, 130	descriptor .....	81, 340
physical-page base address .....	138	page-translation tables .....	138
present (P) .....	138	principle of locality .....	141
read/write (R/W) .....	139	priorities, interrupt .....	232
translation-table base address .....	138	privilege level .....	96
user/supervisor (U/S) .....	139	probe, cache .....	163, 170
paging .....	7, 25, 117	during cache disable .....	182
See also PAE paging and non-PAE paging.		processor feature identification (rFLAGS.ID) .....	55
effect of segment protection .....	148	processor halt .....	159
protection across translation hierarchy .....	147	processor modes	
protection checks .....	145	16-bit .....	xxxvi
supported translations .....	120	32-bit .....	xxxvi
paging enable (CR0.PG) .....	45, 120	64-bit .....	xxxvi
activating long mode .....	120, 437	processor state .....	428
parameter count field .....	88	processor states .....	315
PAT .....	497	protected mode .....	x1, 14, 448
See page-attribute table (PAT).			
PAT bit .....	140		

initial operating environment.....	434	read miss .....	163
protected-mode virtual interrupts (CR4.PVI).....	49	read ordering .....	184
protection checks		read/write (R/W)	
adjusting RPL .....	159	page-translation tables, bit in .....	139
call gate .....	105	readable (R), code segment .....	82
checking access rights.....	158	real address.....	10
data segment .....	97	real address mode. See real mode	
direct call, conforming .....	102	real mode .....	x1, 4, 14
direct call, nonconforming.....	100	initial operating environment .....	434
enabling .....	66	registers	
far return.....	111	See also entries for individual registers.	
interrupt return .....	244	address-breakpoint registers (DR0-DR3) .....	349
interrupt to higher privilege .....	241	control registers .....	29, 41
limit check, 64-bit mode.....	112	control-transfer recording MSRs .....	355
long mode changes .....	27	CR0.....	42
long mode interrupt .....	250	CR2.....	226
long mode interrupt return.....	253	CR3.....	25, 46, 123, 130
stack segment.....	98	CR4.....	47
type check.....	114	CSTAR .....	153
verifying read/write access .....	158	debug registers .....	29, 348
protection domains.....	484	debug-control MSR (DebugCtl) .....	353
protection enable (CR0.PE) .....	43, 66, 73	debug-control register (DR7) .....	351
PS bit.....	122, 139	debug-extension MSRs .....	62
PSE bit.....	49	descriptor-table registers.....	26, 68
PSE paging .....	25	eAX-eSP .....	xlii
P-State .....	559	EFER.....	29, 55
control .....	559	eFLAGS .....	xliii
current limit register .....	560	eIP.....	xliii
status register .....	561	FPR .....	307, 309
PTE .....	122	FS and GS.....	72
PUSH instruction.....	156	GDTR.....	74
PUSHF .....	460	GPRs.....	28
PVI bit.....	49	IDTR .....	79
PWT bit .....	123, 131, 139	IORRBase.....	206
<b>Q</b>		IORRMask.....	207
quadword .....	x1	L2I_PerfEvtSeln.....	368
<b>R</b>		last x87 data pointer.....	307, 309, 323
R bit .....	82	last x87 instruction pointer .....	307, 309, 322
R/W bit.....	139	LDTR .....	76
r8-r15.....	xliii	LSTAR .....	153
RAX.....	448, 449	machine-check MSRs .....	62
rAX-rSP .....	xliii	MCG_CAP .....	266
RAZ .....	x1	MCG_CTL.....	268
RdMem, MTRR type field.....	60, 204	MCG_STATUS .....	267
RDMSR.....	58, 156, 463	MCi_ADDR.....	274
RDP field.....	323	MCi_CTL .....	271
RDPMC.....	50, 460	MCi_MISC .....	274
RDPMC instruction .....	156	MCi_STATUS .....	271
RDTSC.....	49, 62, 157, 370, 460	memory-type range register (MTRR) .....	29, 61, 189
RDTSCP.....	49, 62, 157, 370, 461	MMX .....	305
read hit.....	163	model-specific registers (MSRs) .....	29
		MTRR, fixed range .....	190
		MTRR, variable range.....	192
		MTRRcap .....	196
		MTRRdefType .....	195

MTRRfix16K.....	191	I/O privilege level field (IOPL).....	53
MTRRfix4K.....	191	interrupt flag (IF).....	53, 156
MTRRfix64K.....	191	nested task (NT).....	53, 345
MTRRphysBase.....	192	processor feature identification (ID).....	55
MTRRphysMask.....	193	resume flag (RF).....	54, 217, 360
MXCSR.....	305	trap flag (TF).....	53
NB_PerfEvtSeln.....	367	virtual interrupt (VIF).....	54, 255
PAT.....	199	virtual interrupt pending (VIP).....	55, 255
PerfCtrn.....	363	virtual-8086 mode (VM).....	54
PerfEvtSeln.....	364	rFLAGS register.....	xliv
performance-monitoring MSRs.....	62	RIP.....	449
r8–r15.....	xliii	rIP.....	28
rAX–rSP.....	xliii	rIP register.....	xliv
rFLAGS.....	xliv, 28, 52	RIP-relative address.....	31
rIP.....	xliv	RIP-relative addressing.....	xl
rSP.....	28	RIPV bit.....	267
segment registers.....	70	RPL.....	70, 97, 330
SSE registers.....	28	adjusting.....	159
STAR.....	153	definition.....	97
SYSCFG.....	59	in call gate protection.....	106
SYSENTER_CS.....	154	in data segment protection.....	97, 278
SYSENTER_EIP.....	154	in far return.....	111
SYSENTER_ESP.....	154	in IRET instruction.....	244
system-linkage MSRs.....	61	in protecting conforming CS.....	103
task-priority register (CR8).....	38, 51, 234	in protecting nonconforming CS.....	101
time-stamp counter.....	62, 369	in stack segment protection.....	99
TOP_MEM.....	60, 208	RSM.....	283, 298, 460
TOP_MEM2.....	60, 208	RSP.....	448, 449
x87 FCW.....	307, 309, 322	rSP.....	28
x87 floating-point processor state.....	306	call gate stack switch.....	108
x87 FSW.....	305, 307, 309, 322	implicit reference.....	31
x87 FTW.....	306, 307, 309, 322	<b>S</b>	
x87 opcode.....	307, 309, 322	S bit.....	81, 340
XMM registers.....	304	SBZ.....	xli
relative.....	xl	SCE bit.....	56
replacement, cache-line.....	163	secure initialization.....	490
replicated state.....	492	secure loader (SL).....	498
reserved.....	xl	secure loader (SL) image.....	499
reset.....	427	secure loader block.....	499
processor state.....	428	secure MP initialization.....	502
RESET# signal.....	427	security exception (#SX).....	498, 503
resume flag (rFLAGS.RF).....	54, 217, 360	segment base.....	80
RET instruction.....	111	segment limit.....	80
from 64-bit mode.....	112	segment offset.....	2
long mode.....	33, 111	segment registers.....	68, 70
popping null selector, 64-bit mode.....	112	64-bit mode.....	72
stack switch.....	111	accessing.....	157
retire, instruction.....	164	hidden portion.....	71
revision history.....	xxix	initializing unused registers.....	70
REX prefix.....	29	segmentation.....	5, 26
RF bit.....	54	64-bit mode.....	67
RFLAGS.....	448, 449	combining with paging.....	8
rFLAGS.....	28, 52		
alignment check (AC).....	54, 227		

flat segmentation .....	6, 9, 67	stack exception (#SS) .....	223
multi-segmented model .....	66	stack pointers	
segment-not-present exception (#NP) .....	223	in 32-bit TSS .....	335
segment-override prefix .....	30	in 64-bit TSS .....	337
selector .....	68, 69, 70, 77, 87, 330	stack segment .....	71, 83
selector index .....	70	64-bit mode .....	72
self-modifying code .....	181	default operand size (D) .....	85
SEOI Register .....	537, 557	expand down (E) .....	84
serializing instructions .....	185	privilege checks .....	98
set .....	xli	stack switch	
SF exception .....	226	call gate .....	108
SFENCE .....	166	call gate, long mode .....	33, 109
SFENCE instruction .....	184	far return .....	111
SGDT .....	158, 459	interrupt .....	240
shadow page tables (SPTs) .....	473	interrupt return .....	244
shared state, MOESI .....	169	interrupt, long mode .....	37
shut down .....	221	stack-fault exception (SF) .....	226
SIDT .....	158, 459	STAR register .....	153, 569, 571
SIMD floating-point exception (#XF) ..	50, 229, 303, 304	state switch .....	446
single-step		status word .....	156
all instructions .....	348, 360	stepping ID field .....	431
control-transfers .....	348, 361	STGI .....	461, 474
SKINIT .....	461, 490, 498	STI instruction .....	156
SL abort .....	502	sticky bits .....	xli
SLDT .....	158, 459	store ordering .....	184
SMBASE register .....	285	STR .....	459
SMI .....	283	STR instruction .....	158
external, synchronous .....	481	SVM support .....	481
internal, synchronous .....	481	SWAPGS instruction .....	155
external, asynchronous .....	481	SYSCALL Flag Mask register .....	153
SMM .....	283	SYSCALL, SYSRET instructions .....	56, 152
SMM interrupts .....	294	SYSCFG register .....	59, 570, 573
SMM revision identifier .....	290	MtrrFixDramEn .....	60, 204
SMM state-save area .....	286	MtrrFixDramModEn .....	60, 204
SMM_CTL MSR .....	525	MtrrTom2En .....	210
SMRAM .....	284	MtrrVarDramEn .....	60, 210
SMRAM state-save area .....	286	SYSENTER_CS register .....	154, 567, 572
SMSW .....	459	SYSENTER_EIP register .....	154, 567, 572
SMSW instruction .....	156	SYSENTER_ESP register .....	154, 567, 572
specific EOI (SEOI) .....	556	SYSENTER, SYSEXIT instructions .....	154
speculative execution .....	164	illegal in long mode .....	154
SPT .....	473	system call and return .....	152
Spurious Interrupts .....	545	system data structures .....	17
SS register .....	72, 449	system management interrupt (SMI) .....	283, 293, 481
SS.SEL .....	448	while in SMM .....	294
SSE Instructions		system management mode (SMM) .....	15, 24, 481
subset support .....	301	leaving .....	298
SSE instructions		long mode differences .....	283
enabling .....	303	operating environment .....	293
saving state .....	308	revision identifier .....	290
YMM/XMM registers .....	28, 304	saving processor state .....	295
SSM Containerization .....	589	SMBASE register .....	285
		SMRAM .....	284

state-save area, AMD64 architecture .....	286	TLB flush .....	473
state-save area, legacy .....	289	TLB_CONTROL .....	474
system registers .....	15	top of memory .....	208
system segment .....	27, 80, 85	TOP_MEM register .....	60, 208, 570, 573
ignored fields in 64-bit mode .....	91	TOP_MEM2 register .....	60, 208, 570, 573
illegal types in long mode .....	90	TPM .....	500
long mode .....	90	TPR register .....	38, 51, 235
type field .....	85	TR register .....	328, 331, 459
system-call extension (EFER.SCE) .....	56	translation lookaside buffer (TLB) .....	141
system-linkage MSRs .....	61, 153	trap .....	212
<b>T</b>		trap flag (rFLAGS.TF) .....	53
T bit .....	335	trap gate .....	86, 247
table indicator, selector .....	70	Trigger Mode Register .....	552
tagged TLB .....	446	Trusted Platform Module (TPM) .....	498
task gate .....	86	trusted software .....	498
in task switching .....	343	TS bit .....	44
long mode .....	94	TSC register .....	369, 567, 576
Task Register (TR) .....	68	TSD bit .....	49
task register (TR) .....	331	TSS .....	xli, 328, 333
loading .....	158	TSS descriptor .....	328
selector .....	330	TSS selector .....	87, 328
storing .....	158	type check .....	114
task switch .....	327, 341	Type field .....	81, 331, 340
disabled in long mode .....	38	<b>U</b>	
lazy context switch .....	44, 325	U/S bit .....	139
nesting tasks .....	345	UC bit .....	273
preventing recursion .....	345	UC memory type .....	172
task switched (CR0.TS) .....	44, 156	UD2 instruction .....	219
task, execution space .....	327	UE exception .....	227, 229
task-priority register (CR8) .....	38, 51, 234	uncacheable (UC-), memory type .....	199
task-state segment (TSS)		underflow .....	xli
descriptor .....	330	underflow exception (UE) .....	227, 229
dynamic fields .....	335	user segment .....	80
I/O-permission bitmap .....	335, 338	user/supervisor (U/S)	
interrupt-redirection bitmap .....	336	page-translation tables, bit in .....	139
interrupt-stack table .....	338	<b>V</b>	
legacy 32-bit .....	333	V_IGN_TPR .....	479
link field .....	345	V_INTR_MASKING .....	477
software-defined fields .....	335	V_INTR_PRIO .....	479
stack pointers .....	335, 337	V_INTR_VECTOR .....	479
static fields .....	335	V_IRQ .....	449, 479
TF bit .....	53	V_TPR .....	449, 478, 479
Thermal Sensor .....	532	VAL bit .....	273
Thermal Sensor Interrupts .....	543	Variable-range IORRs .....	206
TI bit .....	70, 330	vector .....	xli
time-stamp counter .....	157, 369	vector, interrupt .....	214
time-stamp disable (CR4.TSD) .....	49, 157, 370	VERR instruction .....	158
TLB .....	140, 141, 448, 449	VERW instruction .....	158
explicit invalidation .....	142, 160	VIF bit .....	54
implicit invalidation .....	143		
TLB Control .....	473		
TLB entry upgrades .....	143		

- VIP bit ..... 55  
virtual #INTR ..... 478  
virtual address ..... 3, 24  
virtual interrupt (rFLAGS.VIF) ..... 54, 255  
virtual interrupt pending (rFLAGS.VIP) ..... 55, 255  
virtual interrupts ..... 53, 54, 55, 253, 255, 446  
virtual interrupts, protected mode ..... 257  
virtual machine control block (VMCB) ..... 447  
virtual machine monitor ..... 445  
virtual memory ..... 3  
virtual-8086 mode ..... xlii, 14  
    interrupt to protected mode ..... 245  
    interrupts ..... 244  
virtual-8086 mode (rFLAGS.VM) ..... 54  
virtual-8086 mode extensions (CR4.VME) ..... 48, 254  
VM bit ..... 54  
VM\_HSAVE\_AREA ..... 449  
VM\_SAVE\_PA MSR ..... 526  
VMCB ..... 448  
VME ..... 254  
VME bit ..... 48, 245  
VMLOAD ..... 448, 460, 470  
VMM ..... 445  
VMMCALL ..... 461, 475  
VMRUN ..... 445, 447, 448, 460  
VMSAVE ..... 448, 460, 470
- W**
- W bit ..... 84  
WAIT/FWAIT instruction ..... 43  
WB memory type ..... 173  
WBINVD ..... 159, 185, 461  
WC memory type ..... 172  
WC+ ..... 496  
world switch ..... 445  
WP bit ..... 44  
WP memory type ..... 173  
writable (W), data segment ..... 84  
write buffer ..... 163, 177  
    emptying ..... 177  
write hit ..... 163  
write miss ..... 163  
write ordering ..... 165, 184  
write protect (CR0.WP) ..... 44  
write-back (WB), memory type ..... 173  
writeback, cache line ..... 163  
write-combining buffer ..... 163, 178  
    emptying ..... 178  
write-combining plus memory type ..... 173  
write-though (WT)  
    memory type ..... 173  
WrMem, MTRR type field ..... 60, 204  
WRMSR ..... 58, 156, 463  
WT memory type ..... 173
- X**
- x87 control word ..... 307, 309, 322  
x87 data pointer register ..... 307, 309, 323  
x87 environment ..... 309  
x87 floating-point instructions  
    initializing ..... 431  
    processor state ..... 306  
    saving state ..... 308  
x87 floating-point state, initialization ..... 429  
x87 instruction pointer register ..... 307, 309, 322  
x87 opcode register ..... 307, 309, 322  
x87 status word ..... 305, 307, 309, 322  
x87 tag word ..... 306, 307, 309, 322  
    FXSAVE format ..... 323  
XMM registers ..... 304
- Y**
- YMM states ..... 317
- Z**
- ZE exception ..... 227, 229  
zero extension ..... 30, 31  
zero-divide exception (ZE) ..... 227, 229

