

Z8036 Z8000® Z-CIO Counter/Timer and Parallel I/O Unit

September 1988

Features

- Two independent 8-bit, double-buffered, bidirectional I/O ports plus a 4-bit special-purpose I/O port. I/O ports feature programmable polarity, programmable direction (Bit mode), "pulse catchers," and programmable open-drain outputs.
- Four handshake modes, including 3-Wire (like the IEEE-488).
- REQUEST/WAIT signal for high-speed data transfer.
- Flexible pattern-recognition logic, programmable as a 16-vector interrupt controller.
- Three independent 16-bit counter/timers with up to four external access lines per counter/timer (count input, output, gate, and trigger), and three output duty cycles (pulsed, one-shot, and square-wave), programmable as retriggerable or nonretriggerable.
- Easy to use since all registers are read/write and directly addressable.

General Description

The Z8036 Z-CIO Counter/Timer and Parallel I/O element is a general-purpose peripheral circuit, satisfying most counter/timer and parallel I/O needs encountered in system designs. This versatile device contains three I/O ports and three counter/timers. Many programmable options tailor its configuration to specific applications.

The use of the device is simplified by making all internal registers (command, status, and data) readable and (except for status bits) writable. In addition, each register is given its own unique address so that it can be accessed directly—no special sequential operations are required. The Z-CIO is directly Z-Bus compatible.

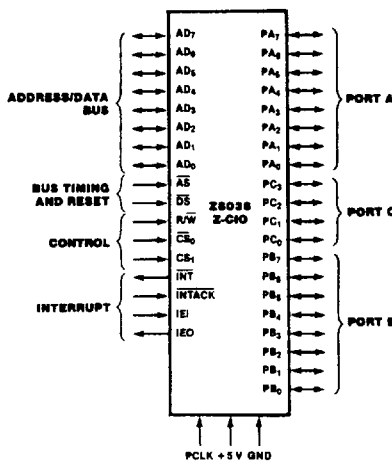

Figure 1. Pin Functions

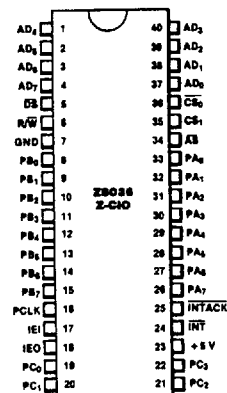

Figure 2a. 40-pin Dual-In-Line Package (DIP) Pin Assignments

Pin Description

AD₀-AD₇. *Z-Bus Address/Data lines* (bidirectional/3-state). These multiplexed Address/Data lines are used for transfers between the CPU and Z-CIO.

AS*. *Address Strobe* (input, active Low). Addresses, $\overline{\text{INTACK}}$, and $\overline{\text{CS}}_0$ are sampled while AS is Low.

CS₀ and CS₁. *Chip Select 0* (input, active Low) and *Chip Select 1* (input, active High). CS₀ and CS₁ must be Low and High, respectively, in order to select a device. CS₀ is latched by AS.

DS*. *Data Strobe* (input, active Low). DS provides timing for the transfer of data into or out of the Z-CIO.

IEI. *Interrupt Enable In* (input, active High). IEI is used with IEO to form an interrupt daisy chain when there is more than one interrupt-driven device. A High IEI indicates that no other higher priority device has an interrupt under service or is requesting an interrupt.

IEO. *Interrupt Enable Out* (output, active High). IEO is High only if IEI is High and the CPU is not servicing an interrupt from the requesting Z-CIO or is not requesting an interrupt (Interrupt Acknowledge cycle only). IEO is connected to the next lower priority device's IEI input and thus inhibits interrupts from lower priority devices.

*When AS and DS are detected Low at the same time (normally an illegal condition), the Z-CIO is reset.

INT. *Interrupt Request* (output, open-drain, active Low). This signal is pulled Low when the Z-CIO requests an interrupt.

INTACK. *Interrupt Acknowledge* (input, active Low). This signal indicates to the Z-CIO that an Interrupt Acknowledge cycle is in progress. INTACK is sampled while AS is Low.

PA₀-PA₇. *Port A I/O lines* (bidirectional, 3-state, or open-drain). These eight I/O lines transfer information between the Z-CIO's Port A and external devices.

PB₀-PB₇. *Port B I/O lines* (bidirectional, 3-state, or open-drain). These eight I/O lines transfer information between the Z-CIO's Port B and external devices. May also be used to provide external access to Counter/Timers 1 and 2.

PC₀-PC₃. *Port C I/O lines* (bidirectional, 3-state, or open-drain). These four I/O lines are used to provide handshake, WAIT, and REQUEST lines for Ports A and B or to provide external access to Counter/Timer 3 or access to the Z-CIO's Port C.

PCLK. (input, TTL-compatible). This is a peripheral clock that may be, but is not necessarily, the CPU clock. It is used with timers and REQUEST/WAIT logic.

R/W. *Read/Write* (input). R/W indicates that the CPU is reading from (High) or writing to (Low) the Z-CIO.

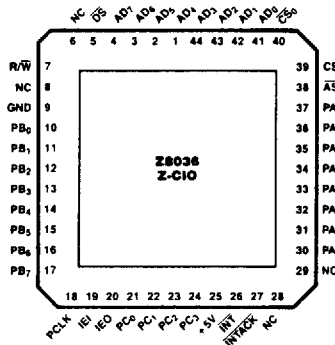

Figure 2b. 44-pin Chip Carrier.
Pin Assignments

Architecture

The Z8036 Z-CIO Counter/Timer and Parallel I/O element (Figure 3) consists of a

Z-Bus interface, three I/O ports (two general-purpose 8-bit ports and one special-purpose

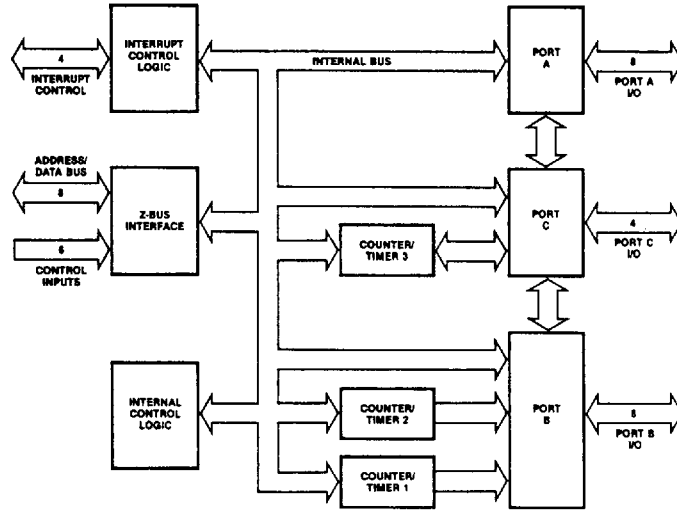

Figure 3. Z-CIO Block Diagram

1

Architecture
(Continued)

4-bit port), three 16-bit counter/timers, an interrupt control logic block, and the internal control logic block. An extensive number of programmable options allow the user to tailor the configuration to best suit the specific application.

The two general-purpose 8-bit I/O ports (Figure 4) are identical, except that Port B can be specified to provide external access to Counter/Timers 1 and 2. Either port can be programmed to be a handshake-driven, double-buffered port (input, output, or bidirectional) or a control-type port with the direction of each bit individually programmable. Each port includes pattern-recognition logic, allowing interrupt generation when a specific pattern is detected. The pattern-recognition logic can be programmed so the port functions like a priority-interrupt controller. Ports A and B can also be linked to form a 16-bit I/O port.

To control these capabilities, both ports contain 12 registers. Three of these registers, the

Input, Output, and Buffer registers, comprise the data path registers. Two registers, the Mode Specification and Handshake Specification registers, are used to define the mode of the port and to specify which handshake, if any, is to be used. The reference pattern for the pattern-recognition logic is defined via three registers: the Pattern Polarity, Pattern Transition, and Pattern Mask registers. The detailed characteristics of each bit path (for example, the direction of data flow or whether a path is inverting or noninverting) are programmed using the Data Path Polarity, Data Direction, and Special I/O Control registers.

The primary control and status bits are grouped in a single register, the Command and Status register, so that after the port is initially configured, only this register must be accessed frequently. To facilitate initialization, the port logic is designed so that registers associated with an unrequired capability are ignored and do not have to be programmed.

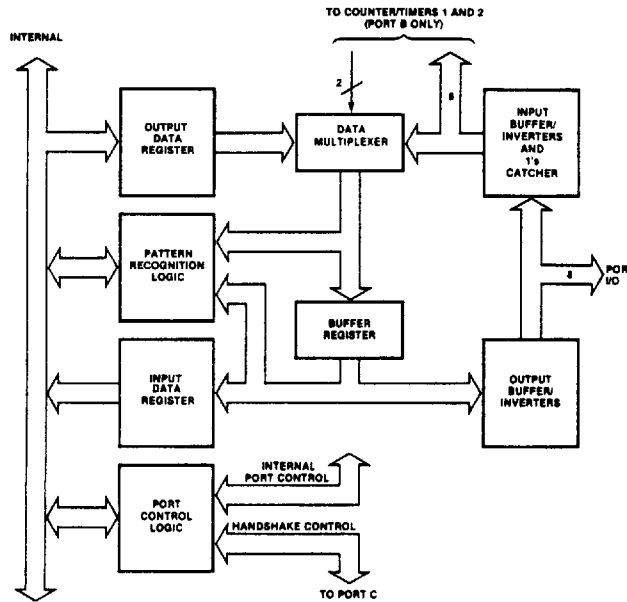

Figure 4. Ports A and B Block Diagram

Architecture
(Continued)

The function of the special-purpose 4-bit port, Port C (Figure 5), depends upon the roles of Ports A and B. Port C provides the required handshake lines. Any bits of Port C not used as handshake lines can be used as I/O lines or to provide external access for the third counter/timer.

Since Port C's function is defined primarily by Ports A and B, only three registers (besides the Data Input and Output registers) are needed. These registers specify the details of each bit path: the Data Path Polarity, Data Direction, and Special I/O Control registers.

The three counter/timers (Figure 6) are all identical. Each is comprised of a 16-bit down-counter, a 16-bit Time Constant register (which holds the value loaded into the down-counter), a 16-bit Current Counter register (used to read the contents of the down-counter), and two 8-bit registers for control and status (the Mode Specification and the Command and Status registers).

The capabilities of the counter/timer are

numerous. Up to four port I/O lines can be dedicated as external access lines for each counter/timer: counter input, gate input, trigger input, and counter/timer output. Three different counter/timer output duty cycles are available: pulse, one-shot, or square-wave. The operation of the counter/timer can be programmed as either retriggerable or nonretriggerable. With these and other options, most counter/timer applications are covered.

The interrupt control logic provides standard Z-Bus interrupt capabilities. There are five registers (Master Interrupt Control register, three Interrupt Vector registers, and the Current Vector register) associated with the interrupt logic. In addition, the ports' Command and Status registers and the counter/timers' Command and Status registers include bits associated with the interrupt logic. Each of these registers contains three bits for interrupt control and status: Interrupt Pending (IP), Interrupt Under Service (IUS), and Interrupt Enable (IE).

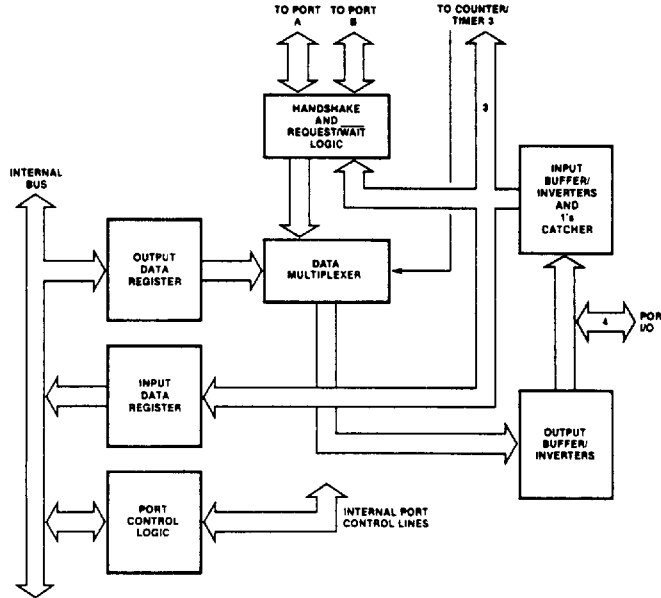

Figure 5. Port C Block Diagram

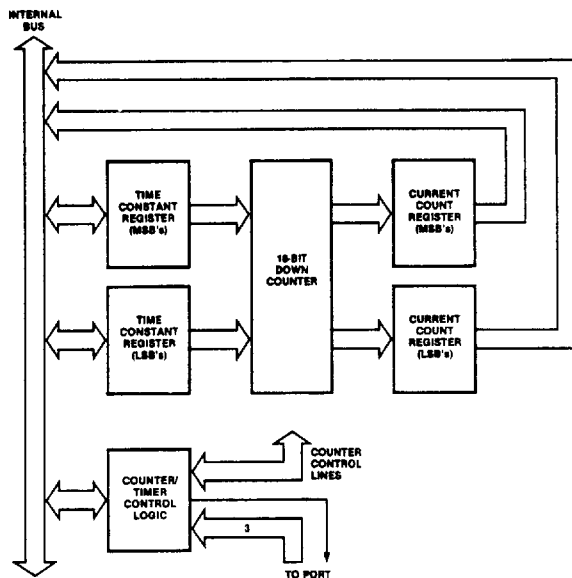

Figure 6. Counter/Timer Block Diagram

Functional Description

The following describes the functions of the ports, pattern-recognition logic, counter/timers, and interrupt logic.

I/O Port Operations. Of the Z-CIO's three I/O ports, two (Ports A and B) are general-purpose, and the third (Port C) is a special-purpose 4-bit port. Ports A and B can be configured as input, output, or bidirectional ports with handshake. (Four different handshakes are available.) They can also be linked to form a single 16-bit port. If they are not used as ports with handshake, they provide 16 input or output bits with the data direction programmable on a bit-by-bit basis. Port B also provides access for Counter/Timers 1 and 2. In all configurations, Ports A and B can be programmed to recognize specific data patterns and to generate interrupts when the pattern is encountered.

The four bits of Port C provide the handshake lines for Ports A and B when required. A REQUEST/WAIT line can also be provided so that Z-CIO transfers can be synchronized with DMAs or CPUs. Any Port C bits not used for handshake or REQUEST/WAIT can be used as input or output bits (individually data direction programmable) or external access lines for Counter/Timer 3. Port C does not contain any pattern-recognition logic. It is, however, capable of bit-addressable writes. With this feature, any combination of bits can be set and/or cleared while the other bits remain undisturbed without first reading the register.

Bit Port Operations. In bit port operations, the

port's Data Direction register specifies the direction of data flow for each bit. A 1 specifies an input bit, and a 0 specifies an output bit. If bits are used as I/O bits for a counter/timer, they should be set as input or output, as required.

The Data Path Polarity register provides the capability of inverting the data path. A 1 specifies inverting, and a 0 specifies non-inverting. All discussions of the port operations assume that the path is noninverting.

The value returned when reading an input bit reflects the state of the input just prior to the read. A 1's catcher can be inserted into the input data path by programming a 1 to the corresponding bit position of the port's Special I/O Control register. When a 1 is detected at the 1's catcher input, its output is set to a 1 until it is cleared. The 1's catcher is cleared by writing a 0 to the bit. In all other cases, attempted writes to input bits are ignored.

When Ports A and B include output bits, reading the Data register returns the value being output. Reads of Port C return the state of the pin. Outputs can be specified as open-drain by writing a 1 to the corresponding bit of the port's Special I/O Control register. Port C has the additional feature of bit-addressable writes. When writing to Port C, the four most significant bits are used as a write protect mask for the least significant bits (0-4, 1-5, 2-6, and 3-7). If the write protect bit is written with a 1, the state of the corresponding output bit is not changed.

Functional Description
(Continued)

Ports with Handshake Operation. Ports A and B can be specified as 8-bit input, output, or bidirectional ports with handshake. The Z-CIO provides four different handshakes for its ports: Interlocked, Strobed, Pulsed, and 3-Wire. When specified as a port with handshake, the transfer of data into and out of the port and interrupt generation is under control of the handshake logic. Port C provides the handshake lines as shown in Table 1. Any Port C lines not used for handshake can be used as simple I/O lines or as access lines for Counter/Timer 3.

When Ports A and B are configured as ports with handshake, they are double-buffered. This allows for more relaxed interrupt service routine response time. A second byte can be input to or output from the port before the interrupt for the first byte is serviced. Normally, the Interrupt Pending (IP) bit is set and an interrupt is generated when data is shifted into the Input register (input port) or out of the Output register (output port). For input and output ports, the IP is automatically cleared when the data is read or written. In bidirectional ports, IP is cleared only by command. When the Interrupt on Two Bytes (ITB) control bit is set to 1, interrupts are generated only when two bytes of data are available to be read or written. This allows a minimum of 16 bits of information to be transferred on each interrupt. With ITB set, the IP is not automatically cleared until the second byte of data is read or written.

When the Single Buffer (SB) bit is set to 1, the port acts as if it is only single-buffered. This is useful if the handshake line must be stopped on a byte-by-byte basis.

Ports A and B can be linked to form a 16-bit port by programming a 1 in the Port Link Control (PLC) bit. In this mode, only Port A's Handshake Specification and Command and Status registers are used. Port B must be specified as a bit port. When linked, only Port

A has pattern-match capability. Port B's pattern-match capability must be disabled. Also, when the ports are linked, Port B's Data register must be read or written before Port A's.

When a port is specified as a port with handshake, the type of port it is (input, output, or bidirectional) determines the direction of data flow. The data direction for the bidirectional port is determined by a bit in Port C (Table 1). In all cases, the contents of the Data Direction register are ignored. The contents of the Special I/O Control register apply only to output bits (3-state or open-drain). Inputs may not have 1's catchers; therefore, those bits in the Special I/O Control register are ignored. Port C lines used for handshake should be programmed as inputs. The handshake specification overrides Port C's Data Direction register for bits that must be outputs. The contents of Port C's Data Path Polarity register still apply.

Interlocked Handshake. In the Interlocked Handshake mode, the action of the Z-CIO must be acknowledged by the external device before the next action can take place. Figure 7 shows timing for Interlocked Handshake. An output port does not indicate that new data is available until the external device indicates it is ready for the data. Similarly, an input port does not indicate that it is ready for new data until the data source indicates that the previous byte of the data is no longer available, thereby acknowledging the input port's acceptance of the last byte. This allows the Z-CIO to interface directly to the port of a Z8 microcomputer, a UPC, an FIO, an FIFO, or to another Z-CIO port with no external logic.

A 4-bit deskew timer can be inserted in the Data Available (\overline{DAV}) output for output ports. As data is transferred to the Buffer register, the deskew timer is triggered. After the number of PCLK cycles specified by the deskew timer time constant plus one, \overline{DAV} is

Port A/B Configuration	PC ₃	PC ₂	PC ₁	PC ₀
Ports A and B: Bit Ports	Bit I/O	Bit I/O	Bit I/O	Bit I/O
Port A: Input or Output Port (Interlocked, Strobed, or Pulsed Handshake)*	RFD or \overline{DAV}	\overline{ACKIN}	REQUEST/ \overline{WAIT} or Bit I/O	Bit I/O
Port B: Input or Output Port (Interlocked, Strobed, or Pulsed Handshake)*	REQUEST/ \overline{WAIT} or Bit I/O	Bit I/O	RFD or \overline{DAV}	\overline{ACKIN}
Port A or B: Input Port (3-Wire Handshake)	RFD (Output)	\overline{DAV} (Input)	REQUEST/ \overline{WAIT} or Bit I/O	DAC (Output)
Port A or B: Output Port (3-Wire Handshake)	\overline{DAV} (Output)	DAC (Input)	REQUEST/ \overline{WAIT} or Bit I/O	RFD (Input)
Port A or B: Bidirectional Port (Interlocked or Strobed Handshake)	RFD or \overline{DAV}	\overline{ACKIN}	REQUEST/ \overline{WAIT} or Bit I/O	IN/ \overline{OUT}

*Both Ports A and B can be specified input or output with Interlocked, Strobed, or Pulsed Handshake at the same time if neither uses REQUEST/ \overline{WAIT} .

Table 1. Port C Bit Utilisation

Functional Description
(Continued)

allowed to go Low. The deskew timer therefore guarantees that the output data is valid for a specified minimum amount of time before \overline{DAV} goes Low. Deskew timers are available for output ports independent of the type of handshake employed.

Strobed Handshake. In the Strobed Handshake mode, data is "strobed" into or out of the port by the external logic. The falling edge of the Acknowledge Input (\overline{ACKIN}) strobes data into or out of the port. Figure 7 shows timing for the Strobed Handshake. In contrast to the Interlocked Handshake, the signal indicating the port is ready for another data transfer operates independently of the \overline{ACKIN} input. It is up to the external logic to ensure that data overflows or underflows do not occur.

3-Wire Handshake. The 3-Wire Handshake is designed for the situation in which one output port is communicating with many input ports simultaneously. It is essentially the same as the Interlocked Handshake, except that two signals are used to indicate if an input port is ready for new data or if it has accepted the present data. In the 3-Wire Handshake (Figure 8), the rising edge of one status line indicates that the port is ready for data, and the rising edge of another status line indicates that the data has been accepted. With the 3-Wire Handshake, the output lines of many input ports can be bussed together with open-drain drivers; the

output port knows when all the ports have accepted the data and are ready. This is the same handshake as is used on the IEEE-488 bus. Because this handshake requires three lines, only one port (either A or B) can be a 3-Wire Handshake port at a time. The 3-Wire Handshake is not available in the bidirectional mode. Because the port's direction can be changed under software control, however, bidirectional IEEE-488-type transfers can be performed.

Pulsed Handshake. The Pulsed Handshake (Figure 9) is designed to interface to mechanical-type devices that require data to be held for long periods of time and need relatively wide pulses to gate the data into or out of the device. The logic is the same as the Interlocked Handshake mode, except that an internal counter/timer is linked to the handshake logic. If the port is specified in the input mode, the timer is inserted in the \overline{ACKIN} path. The external \overline{ACKIN} input triggers the timer and its output is used as the Interlocked Handshake's normal acknowledge input. If the port is an output port, the timer is placed in the Data Available (\overline{DAV}) output path. The timer is triggered when the normal Interlocked Handshake \overline{DAV} output goes Low and the timer output is used as the actual \overline{DAV} output. The counter/timer maintains all of its normal capabilities. This handshake is not available to bidirectional ports.

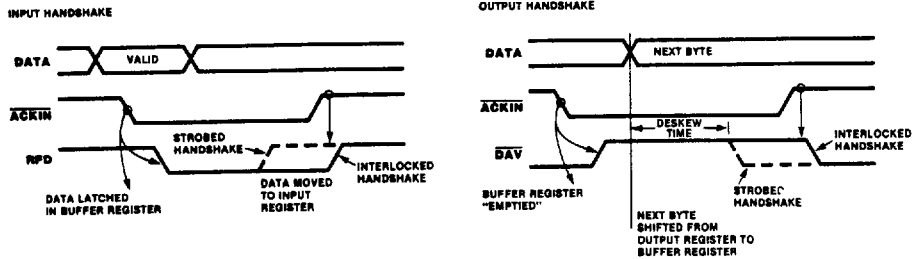

Figure 7. Interlocked and Strobed Handshakes

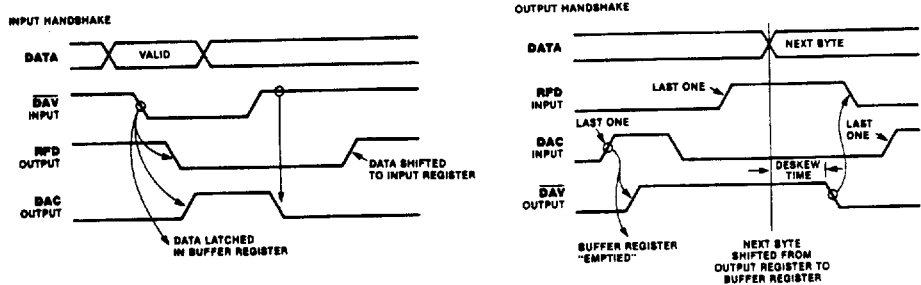

Figure 8. 3-Wire Handshake

Functional Description
(Continued)

REQUEST/WAIT Line Operation. Port C can be programmed to provide a status signal output in addition to the normal handshake lines for either Port A or B when used as a port with handshake. The additional signal is either a REQUEST or WAIT signal. The REQUEST signal indicates when a port is ready to perform a data transfer via the Z-Bus. It is intended for use with a DMA-type device. The WAIT signal provides synchronization for transfers with a CPU. Three bits in the Port Handshake Specification register provide controls for the REQUEST/WAIT logic. Because the extra Port C line is used, only one port can be specified as a port with a handshake and a REQUEST/WAIT line. The other port must be a bit port.

Operation of the REQUEST line is modified by the state of the port's Interrupt on Two Bytes (ITB) control bit. When ITB is 0, the REQUEST line goes active as soon as the Z-CIO is ready for a data transfer. If ITB is 1, REQUEST does not go active until two bytes can be transferred. REQUEST stays active as long as a byte is available to be read or written.

The SPECIAL REQUEST function is reserved for use with bidirectional ports only. In this case, the REQUEST line indicates the status of the register not being used in the data path at that time. If the IN/OUT line is High, the REQUEST line is High when the Output register is empty. If IN/OUT is Low, the REQUEST line is High when the Input register is full.

Pattern-Recognition Logic Operation. Both Ports A and B can be programmed to generate interrupts when a specific pattern is recognized at the port. The pattern-recognition logic is independent of the port application, thereby allowing the port to recognize patterns in all of its configurations. The pattern can be independently specified for each bit as 1, 0, rising edge, falling edge, or any transition. Individual bits may be masked off. A pattern-match is defined as the simultaneous satisfaction of all nonmasked bit specifications in the AND mode or the satisfaction of any non-masked bit specifications in either of the OR or OR-Priority Encoded Vector modes.

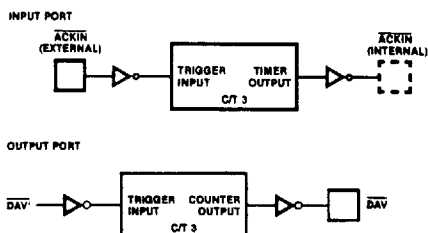

Figure 9. Pulsed Handshake

The pattern specified in the Pattern Definition register assumes that the data path is programmed to be noninverting. If an input bit in the data path is programmed to be inverting, the pattern detected is the opposite of the one specified. Output bits used in the pattern-match logic are internally sampled before the invert/noninvert logic.

Bit Port Pattern-Recognition Operations. During bit port operations, pattern-recognition may be performed on all bits, including those used as I/O for the counter/timers. The input to the pattern-recognition logic follows the value at the pins (through the invert/noninvert logic) in all cases except for simple inputs with 1's catchers. In this case, the output of the 1's catcher is used. When operating in the AND or OR mode, it is the transition from a no-match to a match state that causes the interrupt. In the "OR" mode, if a second match occurs before the first match goes away, it does not cause an interrupt. Since a match condition only lasts a short time when edges are specified, care must be taken to avoid losing a match condition. Bit ports specified in the OR-Priority Encoded Vector mode generate interrupts as long as any match state exists. A transition from a no-match to a match state is not required.

The pattern-recognition logic of bit ports operates in two basic modes: Transparent and Latched. When the Latch on Pattern Match (LPM) bit is set to 0 (Transparent mode), the interrupt indicates that a specified pattern has occurred, but a read of the Data register does not necessarily indicate the state of the port at the time the interrupt was generated. In the Latched mode (LPM = 1), the state of all the port inputs at the time the interrupt was generated is latched in the input register and held until IP is cleared. In all cases, the PMF indicates the state of the port at the time it is read.

If a match occurs while IP is already set, an error condition exists. If the Interrupt On Error bit (IOE) is 0, the match is ignored. However, if IOE is 1, after the first IP is cleared, it is automatically set to 1 along with the Interrupt Error (ERR) flag. Matches occurring while ERR is set are ignored. ERR is cleared when the corresponding IP is cleared.

When a pattern-match is present in the OR-Priority Encoded Vector mode, IP is set to 1. The IP cannot be cleared until a match is no longer present. If the interrupt vector is allowed to include status, the vector returned during Interrupt Acknowledge indicates the highest priority bit matching its specification at the time of the Acknowledge cycle. Bit 7 is the highest priority and bit 0 is the lowest. The bit initially causing the interrupt may not be the one indicated by the vector if a higher priority bit matches before the Acknowledge. Once the Acknowledge cycle is initiated, the vector is

Functional Description
(Continued)

frozen until the corresponding IP is cleared. Where inputs that cause interrupts might change before the interrupt is serviced, the 1's catcher can be used to hold the value. Because a no-match to match transition is not required, the source of the interrupt must be cleared before IP is cleared or else a second interrupt is generated. No error detection is performed in this mode and the Interrupt On Error bit should be set to 0.

Ports with Handshake Pattern-Recognition Operation. In this mode, the handshake logic normally controls the setting of IP and, therefore, the generation of interrupt requests. The pattern-match logic controls the Pattern Match Flag (PMF). The data is compared with the match pattern when it is shifted from the Buffer register to the Input register (input port) or when it is shifted from the Output register to the Buffer register (output port). The pattern-match logic can override the handshake logic in certain situations. If the port is programmed to interrupt when two bytes of data are available to be read or written, but the first byte matches the specified pattern, the pattern-recognition logic sets IP and generates an interrupt. While PMF is set, IP cannot be cleared by reading or writing the data registers. IP must be cleared by command. The input register is not emptied while IP is set, nor is the output register filled until IP is cleared.

If the Interrupt on Match Only (IMO) bit is set, IP is set only when the data matches the pattern. This is useful in DMA-type applications when interrupts are required only after a block of data is transferred.

Counter/Timer Operation. The three independent 16-bit counter/timers consist of a presetable 16-bit down counter, a 16-bit Time Constant register, a 16-bit Current Counter register, an 8-bit Mode Specification register, an 8-bit Command and Status register, and the associated control logic that links these registers.

Function	C/T ₁	C/T ₂	C/T ₃
Counter/Timer Output	PB 4	PB 0	PC 0
Counter Input	PB 5	PB 1	PC 1
Trigger Input	PB 6	PB 2	PC 2
Gate Input	PB 7	PB 3	PC 3

Table 2. Counter/Timer External Access

The flexibility of the counter/timers is enhanced by the provision of up to four lines per counter/timer (counter input, gate input, trigger input, and counter/timer output) for direct external control and status. Counter/Timer 1's external I/O lines are provided by the four most significant bits of Port B. Counter/Timer 2's are provided by the four least significant bits of Port B. Counter/Timer 3's external I/O lines are provided by the four bits of Port C. The utilization of these lines (Table 2) is programmable on a bit-by-bit basis via the Counter/Timer Mode Specification registers.

When external counter/timer I/O lines are to be used, the associated port lines must be vacant and programmed in the proper data direction. Lines used for counter/timer I/O have the same characteristics as simple input lines. They can be specified as inverting or noninverting; they can be read and used with the pattern-recognition logic. They can also include the 1's catcher input.

Counter/Timers 1 and 2 can be linked internally in three different ways. Counter/Timer 1's output (inverted) can be used as Counter/Timer 2's trigger, gate, or counter input. When linked, the counter/timers have the same capabilities as when used separately. The only restriction is that when Counter/Timer 1 drives Counter/Timer 2's count input, Counter/Timer 2 must be programmed with its external count input disabled.

There are three duty cycles available for the timer/counter output: pulse, one-shot, and square-wave. Figure 10 shows the counter/

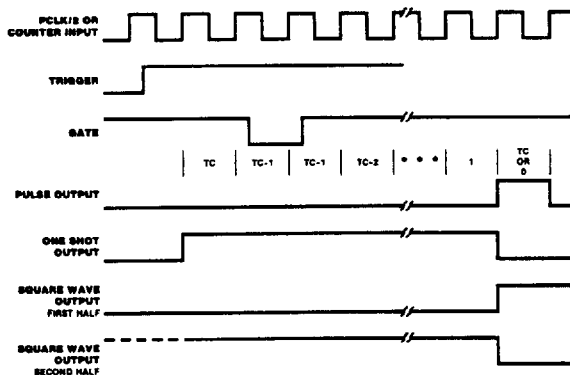

Figure 10. Counter/Timer Waveforms

Functional Description
(Continued)

timer waveforms. When the Pulse mode is specified, the output goes High for one clock cycle, beginning when the down-counter leaves the count of 1. In the One-Shot mode, the output goes High when the counter/timer is triggered and goes Low when the down-counter reaches 0. When the square-wave output duty cycle is specified, the counter/timer goes through two full sequences for each cycle. The initial trigger causes the down-counter to be loaded and the normal count-down sequence to begin. If a 1 count is detected on the down-counter's clocking edge, the output goes High and the time constant value is reloaded. On the clocking edge, when both the down-counter and the output are 1's, the output is pulled back Low.

The Continuous/Single Cycle (C/\overline{SC}) bit in the Mode Specification register controls operation of the down-counter when it reaches terminal count. If C/\overline{SC} is 0 when a terminal count is reached, the countdown sequence stops. If the C/\overline{SC} bit is 1 each time the countdown counter reaches 1, the next cycle causes the time constant value to be reloaded. The time constant value may be changed by the CPU, and on reload, the new time constant value is loaded.

Counter/timer operations require loading the time constant value in the Time Constant register and initiating the countdown sequence by loading the down-counter with the time constant value. The Time Constant register is accessed as two 8-bit registers. The registers are readable as well as writable, and the access order is irrelevant. A 0 in the Time Constant register specifies a time constant of 65,536. The down-counter is loaded in one of three ways: by writing a 1 to the Trigger Command Bit (TCB) of the Command and Status register, on the rising edge of the external trigger input, or, for Counter/Timer 2 only, on the rising edge of Counter/Timer 1's internal output if the counters are linked via the trigger input. The TCB is write-only, and read always returns 0.

Once the down-counter is loaded, the countdown sequence continues toward terminal count as long as all the counter/timers' hardware and software gate inputs are High. If any of the gate inputs goes Low (0), the countdown halts. It resumes when all gate inputs are 1 again.

The reaction to triggers occurring during a countdown sequence is determined by the state of the Retrigger Enable Bit (REB) in the Mode Specification register. If REB is 0, retriggers are ignored and the countdown continues normally. If REB is 1, each trigger causes the down-counter to be reloaded and the countdown sequence starts over again. If the output

is programmed in the Square-Wave mode, retrigger causes the sequence to start over from the initial load of the time constant.

The rate at which the down-counter counts is determined by the mode of the counter/timer. In the Timer mode (the External Count Enable [ECE] bit is 0), the down-counter is clocked internally by a signal that is half the frequency of the PCLK input to the chip. In the Counter mode (ECE is 1), the down-counter is decremented on the rising edge of the counter/timer's counter input.

Each time the counter reaches terminal count, its Interrupt Pending (IP) bit is set to 1, and if interrupts are enabled ($IE = 1$), an interrupt is generated. If a terminal count occurs while IP is already set, an internal error flag is set. As soon as IP is cleared, it is forced to a 1 along with the Interrupt Error (ERR) flag. Errors that occur after the internal flag is set are ignored.

The state of the down-counter can be determined in two ways: by reading the contents of the down-counter via the Current Count register or by testing the Count In Progress (CIP) status bit in the Command and Status register. The CIP status bit is set when the down-counter is loaded; it is reset when the down-counter reaches 0. The Current Count register is a 16-bit register, accessible as two 8-bit registers, which mirrors the contents of the down-counter. This register can be read anytime. However, reading the register is asynchronous to the counter's counting, and the value returned is valid only if the counter is stopped. The down-counter can be reliably read "on the fly" by the first writing of a 1 to the Read Counter Control (RCC) bit in the counter/timer's Command and Status register. This freezes the value in the Current Count register until a read of the least significant byte is performed.

Interrupt Logic Operation. The interrupts generated by the Z-CIO follow the Z-Bus operation as described more fully in the Zilog *Z-Bus Summary*. The Z-CIO has five potential sources of interrupts: the three counter/timers and Ports A and B. The priorities of these sources are fixed in the following order: Counter/Timer 3, Port A, Counter/Timer 2, Port B, and Counter/Timer 1. Since the counter/timers all have equal capabilities and Ports A and B have equal capabilities, there is no adverse impact from the relative priorities.

The Z-CIO interrupt priority, relative to other components within the system, is determined by an interrupt daisy chain. Two pins, Interrupt Enable In (IEI) and Interrupt Enable Out (IEO), provide the input and output necessary to implement the daisy chain. When IEI is pulled Low by a higher priority device,

Functional Description
(Continued)

the Z-CIO cannot request an interrupt of the CPU. The following discussion assumes that the IEI line is High.

Each source of interrupt in the Z-CIO contains three bits for the control and status of the interrupt logic: an Interrupt Pending (IP) status bit, an Interrupt Under Service (IUS) status bit, and an Interrupt Enable (IE) control bit. IP is set when an event requiring CPU intervention occurs. The setting of IP results in forcing the Interrupt (INT) output Low, if the associated IE is 1.

The IUS status bit is set as a result of the Interrupt Acknowledge cycle by the CPU and is set only if its IP is of highest priority at the time the Interrupt Acknowledge commences. It can also be set directly by the CPU. Its primary function is to control the interrupt daisy chain. When set, it disables lower priority sources in the daisy chain, so that lower priority interrupt sources do not request servicing while higher priority devices are being serviced.

The IE bit provides the CPU with a means of masking off individual sources of interrupts. When IE is set to 1, an interrupt is generated normally. When IE is set to 0, the IP bit is set when an event occurs that would normally require service; however, the INT output is not forced Low.

The Master Interrupt Enable (MIE) bit allows all sources of interrupts within the Z-CIO to be disabled without having to individually set each IE to 0. If MIE is set to 0, all IPs are masked off and no interrupt can be requested or acknowledged. The Disable Lower Chain

(DLC) bit is included to allow the CPU to modify the system daisy chain. When the DLC bit is set to 1, the Z-CIO's IEO is forced Low, independent of the state of the Z-CIO or its IEI input, and all lower priority devices' interrupts are disabled.

As part of the Interrupt Acknowledge cycle, the Z-CIO is capable of responding with an 8-bit interrupt vector that specifies the source of the interrupt. The Z-CIO contains three vector registers: one for Port A, one for Port B, and one shared by the three counter/timers. The vector output is inhibited by setting the No Vector (NV) control bit to 1. The vector output can be modified to include status information to pinpoint more precisely the cause of interrupt. Whether the vector includes status or not is controlled by a Vector Includes Status (VIS) control bit. Each base vector has its own VIS bit and is controlled independently. When MIE = 1, reading the base vector register always includes status, independent of the state of the VIS bit. In this way, all the information obtained by the vector, including status, can be obtained with one additional instruction when VIS is set to 0. When MIE = 0, reading the vector register returns the unmodified base vector so that it can be verified. Another register, the Current Vector register, allows use of the Z-CIO in a polled environment. When read, the data returned is the same as the interrupt vector that would be output in an acknowledge, based on the highest priority IP set. If no unmasked IPs are set, the value FFH is returned. The Current Vector register is read-only.

Programming

Programming the Z-CIO entails loading control registers with bits to implement the desired operation. Individual enable bits are provided for the various major blocks so that erroneous operations do not occur while the part is being initialized. Before the ports are enabled, IPs cannot be set, REQUEST and WAIT cannot be asserted, and all outputs remain high-impedance. The handshake lines are ignored until Port C is enabled. The counter/timers cannot be triggered until their enable bits are set.

The Z-CIO is reset by forcing \overline{AS} and \overline{DS} Low simultaneously or by writing a 1 to the Reset bit. Once reset, the only thing that can be done is to read and write the Reset bit. Writes to all other bits are ignored and all reads return 0s. In this state, all control bits are forced to 0. Only after clearing the Reset

bit (by writing to it) can the other command bits be programmed.

Register Addressing. The Z-CIO allows two schemes for register addressing. Both schemes use only six of the eight bits of the address/data bus. The scheme used is determined by the Right Justify Address (RJA) bit in the Master Interrupt Control register. When RJA equals 0, address bus bits 0 and 7 are ignored, and bits 1 through 6 are decoded for the register address (A_0 from AD_1). When RJA equals 1, bits 0 through 5 are decoded for the register address (A_0 from AD_0). In the following register descriptions, only six bits are shown for addresses and represent address/data bus bits 0 through 5 or 1 through 6, depending on the state of the RJA bit.

Registers

Master Interrupt Control Register

Address: 000000
(Read/Write)

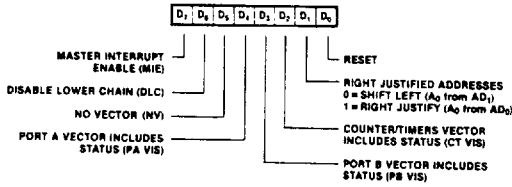

Master Configuration Control Register

Address: 000001
(Read/Write)

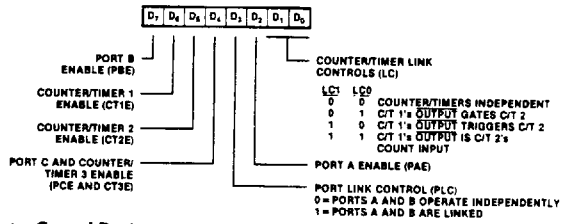
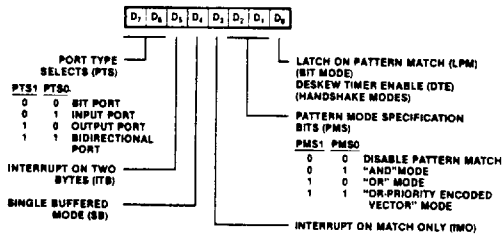

Figure 11. Master Control Registers

Port Mode Specification Registers

Addresses: 100000 Port A
101000 Port B
(Read/Write)



Port Handshake Specification Registers

Addresses: 100001 Port A
101001 Port B
(Read/Write)

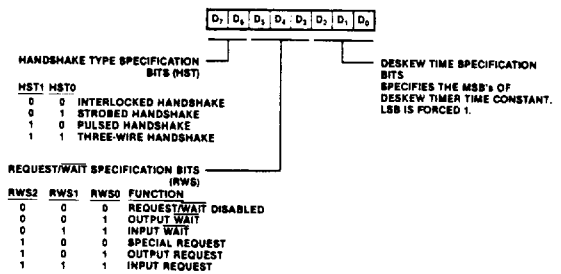

Port Command and Status Registers

Addresses: 001000 Port A
001001 Port B
(Read/Partial Write)

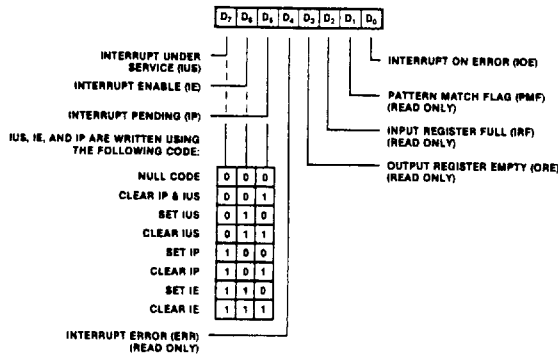

Figure 12. Port Specification Registers

1

Registers
(Continued)

Data Path Polarity Registers

Addresses: 100010 Port A
101010 Port B
000101 Port C (4 LSBs only)
(Read/Write)



DATA PATH POLARITY (DPP)
0 = NON-INVERTING
1 = INVERTING

Data Direction Registers

Addresses: 100011 Port A
101011 Port B
000110 Port C (4 LSBs only)
(Read/Write)



DATA DIRECTION (DDI)
0 = OUTPUT BIT
1 = INPUT BIT

Special I/O Control Registers

Addresses: 100100 Port A
101100 Port B
000111 Port C (4 LSBs only)
(Read/Write)

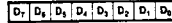

SPECIAL INPUT/OUTPUT (SIO)
0 = NORMAL INPUT OR OUTPUT
1 = OUTPUT WITH OPEN DRAIN OR
INPUT WITH 1's CATCHER

Figure 13. Bit Path Definition Registers

Port Data Registers

Addresses: 001101 Port A
001110 Port B
(Read/Write)



Port C Data Register

Address: 001111
(Read/Write)

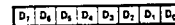

4 MSBs
0 = WRITING OF CORRESPONDING LSB ENABLED
1 = WRITING OF CORRESPONDING LSB INHIBITED
(READ RETURNS ?)

Figure 14. Port Data Registers

Pattern Polarity Registers (PP)

Addresses: 100101 Port A
101101 Port B
(Read/Write)



Pattern Transition Registers (PT)

Addresses: 100110 Port A
101110 Port B
(Read/Write)

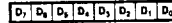

Pattern Mask Registers (PM)

Addresses: 100111 Port A
101111 Port B
(Read/Write)



PM	PT	PP	PATTERN SPECIFICATION
0	0	X	BIT MASKED OFF
0	1	X	ANY TRANSITION
1	0	0	ZERO
1	0	1	ONE
1	1	0	ONE-TO-ZERO TRANSITION (Z)
1	1	1	ZERO-TO-ONE TRANSITION (O)

Figure 15. Pattern Definition Registers

Registers
(Continued)

Counter/Timer Command and Status Registers

Addresses: 001010 Counter/Timer 1
001011 Counter/Timer 2
001100 Counter/Timer 3
(Read/Partial Write)

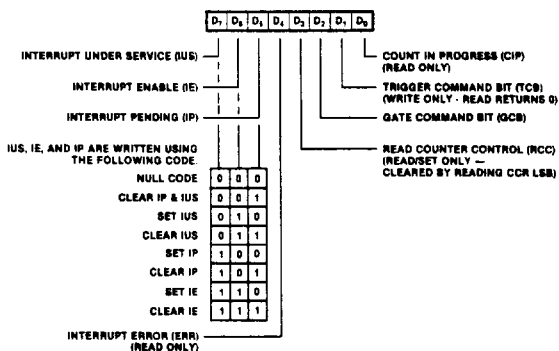

Counter/Timer Mode Specification Registers

Addresses: 011100 Counter/Timer 1
011101 Counter/Timer 2
011110 Counter/Timer 3
(Read/Write)

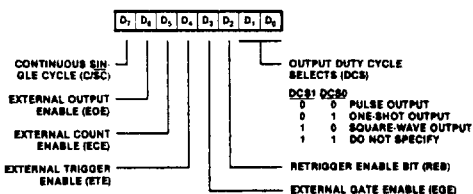

Counter/Timer Current Count Registers

Addresses: 010000 Counter/Timer 1's MSB
010001 Counter/Timer 1's LSB
010010 Counter/Timer 2's MSB
010011 Counter/Timer 2's LSB
010100 Counter/Timer 3's MSB
010101 Counter/Timer 3's LSB
(Read Only)

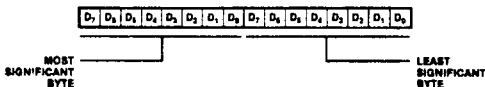

Counter/Timer Time Constant Registers

Addresses: 010110 Counter/Timer 1's MSB
010111 Counter/Timer 1's LSB
011000 Counter/Timer 2's MSB
011001 Counter/Timer 2's LSB
011010 Counter/Timer 3's MSB
011011 Counter/Timer 3's LSB
(Read/Write)

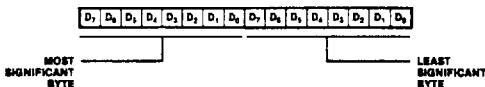

Figure 16. Counter/Timer Registers

Registers
(Continued)

Interrupt Vector Register
Addresses: 000010 Port A
000011 Port B
000100 Counter/Timers
(Read/Write)

Current Vector Register
Address: 011111
(Read Only)



INTERRUPT VECTOR BASED ON HIGHEST PRIORITY UNMASKED IP. IF NO INTERRUPT PENDING ALL 1's OUTPUT.

PORT VECTOR STATUS

PRIORITY ENCODED VECTOR MODE:



ALL OTHER MODES:

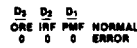

COUNTER/TIMER STATUS

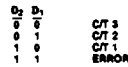

Figure 17. Interrupt Vector Registers

Register Address Summary

Main Control Registers		Port A Specification Registers	
Address*	Register Name	Address*	Register Name
000000	Master Interrupt Control	100000	Port A's Mode Specification
000001	Master Configuration Control	100001	Port A's Handshake Specification
000010	Port A's Interrupt Vector	100010	Port A's Data Path Polarity
000011	Port B's Interrupt Vector	100011	Port A's Data Direction
000100	Counter/Timer's Interrupt Vector	100100	Port A's Special I/O Control
000101	Port C's Data Path Polarity	100101	Port A's Pattern Polarity
000110	Port C's Data Direction	100110	Port A's Pattern Transition
000111	Port C's Special I/O Control	100111	Port A's Pattern Mask
Most Often Accessed Registers		Port B Specification Registers	
Address*	Register Name	Address*	Register Name
001000	Port A's Command and Status	101000	Port B's Mode Specification
001001	Port B's Command and Status	101001	Port B's Handshake Specification
001010	Counter/Timer 1's Command and Status	101010	Port B's Data Path Polarity
001011	Counter/Timer 2's Command and Status	101011	Port B's Data Direction
001100	Counter/Timer 3's Command and Status	101100	Port B's Special I/O Control
001101	Port A's Data	101101	Port B's Pattern Polarity
001110	Port B's Data	101110	Port B's Pattern Transition
001111	Port C's Data	101111	Port B's Pattern Mask
Counter/Timer Related Registers			
Address*	Register Name		
010000	Counter/Timer 1's Current Count-MSBs		
010001	Counter/Timer 1's Current Count-LSBs		
010010	Counter/Timer 2's Current Count-MSBs		
010011	Counter/Timer 2's Current Count-LSBs		
010100	Counter/Timer 3's Current Count-MSBs		
010101	Counter/Timer 3's Current Count-LSBs		
010110	Counter/Timer 1's Time Constant-MSBs		
010111	Counter/Timer 1's Time Constant-LSBs		
011000	Counter/Timer 2's Time Constant-MSBs		
011001	Counter/Timer 2's Time Constant-LSBs		
011010	Counter/Timer 3's Time Constant-MSBs		
011011	Counter/Timer 3's Time Constant-LSBs		
011100	Counter/Timer 1's Mode Specification		
011101	Counter/Timer 2's Mode Specification		
011110	Counter/Timer 3's Mode Specification		
011111	Current Vector		

*When RJA = 0, A₀ from AD₁; when RJA = 1, A₀ from AD₀

Timing

Read Cycle. The CPU places an address on the address/data bus. The more significant bits and status information are combined and decoded by external logic to provide two Chip Selects (\overline{CS}_0 and CS_1). Six bits of the least significant byte of the address are latched within the Z-CIO and used to specify a Z-CIO register. The data from the register specified is strobed onto the address/data bus when the CPU issues a Data Strobe (\overline{DS}). If the register indicated by the address does not exist, the Z-CIO remains high-impedance.

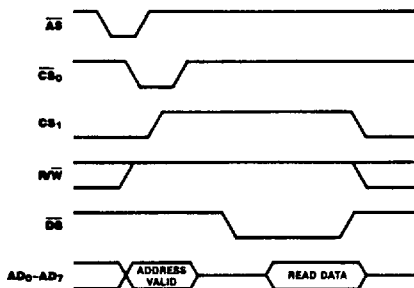

Figure 18. Read Cycle Timing

Write Cycle. The CPU places an address on the address/data bus. The more significant bits and status information are combined and decoded by external logic to provide two Chip Selects (\overline{CS}_0 and CS_1). Six bits of the least significant byte of the address are latched within the Z-CIO and used to specify a Z-CIO register. The CPU places the data on the address/data bus and strobes it into the Z-CIO register by issuing a Data Strobe (\overline{DS}).

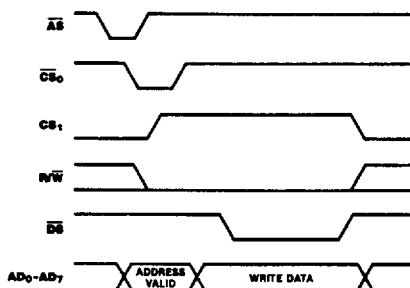
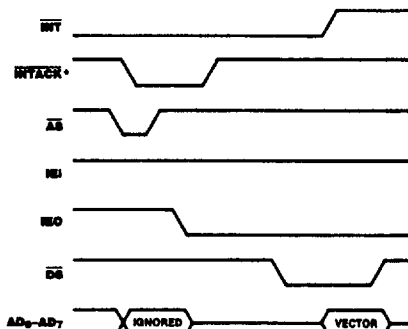

Figure 19. Write Cycle Timing

Interrupt Acknowledge Cycle. When one of the IP bits in the Z-CIO goes High and interrupts are enabled, the Z-CIO pulls its \overline{INT} output line Low, requesting an interrupt. The CPU responds with an Interrupt Acknowledge cycle. When \overline{INTACK} goes Low with IP set, the Z-CIO pulls its Interrupt Enable Out (IEO)

Low, disabling all lower priority devices on the daisy chain. The CPU reads the Z-CIO interrupt vector by issuing a Low \overline{DS} , thereby strobing the interrupt vector onto the address/data bus. The IUS that corresponds to the IP is also set, which causes IEO to remain Low.



*INTACK is decoded from Z8000 status.

Figure 20. Interrupt Acknowledge Timing

Absolute Maximum Ratings
 Voltages on all pins with respect to GND -0.3V to +7.0V
 Operating Ambient Temperature See Ordering Information
 Storage Temperature -65°C to +150°C

Stresses greater than those listed under Absolute Maximum Ratings may cause permanent damage to the device. This is a stress rating only; operation of the device at any condition above those indicated in the operational sections of these specifications is not implied. Exposure to absolute maximum rating conditions for extended periods may affect device reliability.

Standard Test Conditions
 The DC characteristics and capacitance sections below apply for the following standard test conditions, unless otherwise noted. All voltages are referenced to GND. Positive current flows into the referenced pin.

- Standard conditions are as follows:
 ■ $+4.75\text{ V} \leq V_{CC} \leq +5.25\text{ V}$

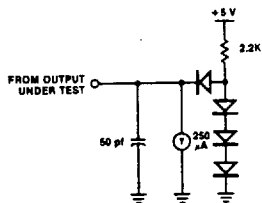

Figure 21. Standard Test Load

- $GND = 0\text{ V}$
 ■ T_A as specified in Ordering Information

All ac parameters assume a load capacitance of 50 pF max.

The Ordering Information section lists temperature ranges and product numbers. Package drawings are in the Package Information section in this book. Refer to the Literature List for additional documentation.

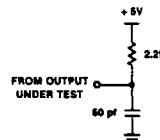

Figure 22. Open-Drain Test Load

DC Characteristics	Symbol	Parameter	Min	Max	Unit	Condition
	V_{IH}	Input High Voltage	2.0	$V_{CC} + 0.3$	V	
	V_{IL}	Input Low Voltage	-0.3	0.8	V	
	V_{OH}	Output High Voltage	2.4		V	$I_{OH} = -250\ \mu\text{A}$
	V_{OL}	Output Low Voltage		0.4	V	$I_{OL} = +2.0\ \text{mA}$
	I_{iL}	Input Leakage		± 10.0	μA	$I_{OL} = +3.2\ \text{mA}$
	I_{oL}	Output Leakage		± 10.0	μA	$0.4 \leq V_{IN} \leq +2.4\ \text{V}$
	I_{CC}	V_{CC} Supply Current		200	mA	$0.4 \leq V_{OUT} \leq +2.4\ \text{V}$

$V_{CC} = 5\text{ V} \pm 5\%$ unless otherwise specified, over specified temperature range.

Capacitance	Symbol	Parameter	Min	Max	Unit	Test Condition
	C_{IN}	Input Capacitance		10	pf	
	C_{OUT}	Output Capacitance		15	pf	
	$C_{I/O}$	Bidirectional Capacitance		20	pf	

$f = 1\ \text{MHz}$, over specified temperature range.
 Unmeasured pins returned to ground.

**CPU
Interface
Timing**

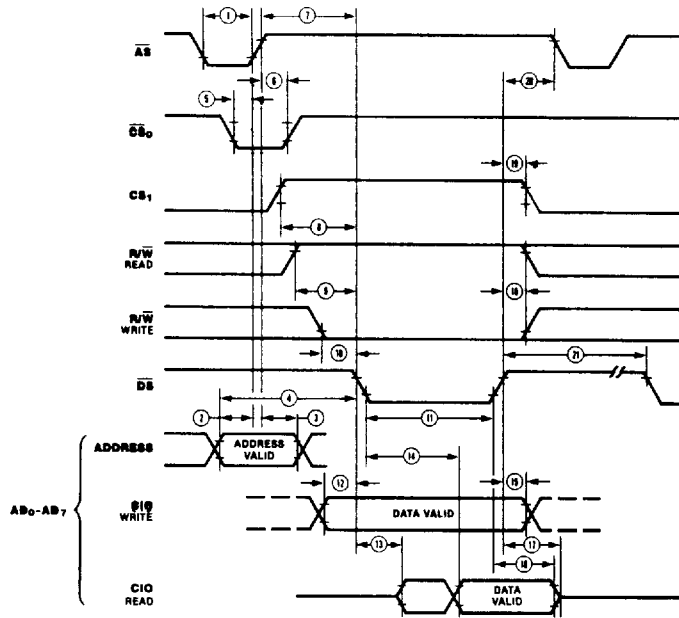

1

**Interrupt
Timing**

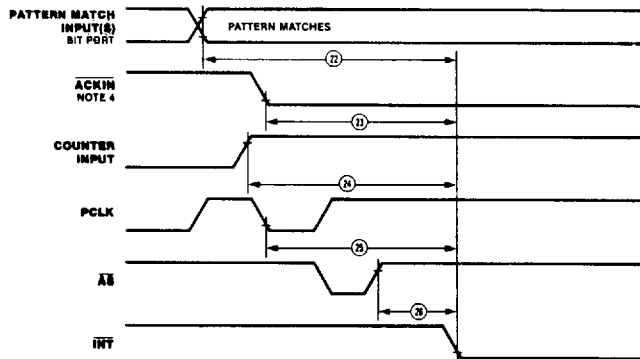

**Interrupt
Acknowledge
Timing**

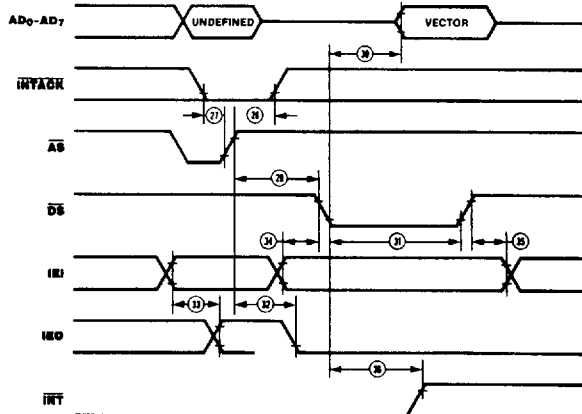

No.	Symbol	Parameter	4 MHz		6 MHz		Notes††
			Min	Max	Min	Max	
1	TwAS	\overline{AS} Low Width	70	2000	50	2000	
2	TsA(AS)	Address to \overline{AS} ↑ Setup Time	30		10		1
3	ThA(AS)	Address to \overline{AS} ↑ Hold Time	50		30		1
4	TsA(DS)	Address to \overline{DS} ↑ Setup Time	130		100		1
5	TsCSO(AS)	\overline{CS}_0 to \overline{AS} ↑ Setup Time	0		0		1
6	ThCSO(AS)	\overline{CS}_0 to \overline{AS} ↑ Hold Time	60		40		1
7	TdAS(DS)	\overline{AS} ↑ to \overline{DS} ↓ Delay	60		40		1
8	TsCS1(DS)	CS_1 to \overline{DS} ↓ Setup Time	100		80		
9	TsRWR(DS)	R/W (Read) to \overline{DS} ↓ Setup Time	100		80		
10	TsRWW(DS)	R/W (Write) to \overline{DS} ↓ Setup Time	0		0		
11	TwDS	\overline{DS} Low Width	390		250		
12	TsDW(DSf)	Write Data to \overline{DS} ↓ Setup Time	30		20		
13	TdDS(DRV)	\overline{DS} (Read) ↓ to Address Data Bus Driven	0		0		
14	TdDSI(DR)	\overline{DS} ↓ to Read Data Valid Delay		250		180	
15	ThDW(DS)	Write Data to \overline{DS} ↓ Hold Time	30		20		
16	TdDSr(DR)	\overline{DS} ↓ to Read Data Not Valid Delay	0		0		
17	TdDS(DRz)	\overline{DS} ↓ to Read Data Float Delay		70		45	2
18	ThRW(DS)	R/W to \overline{DS} ↓ Hold Time	55		40		
19	ThCS1(DS)	CS_1 to \overline{DS} ↓ Hold Time	55		40		
20	TdDS(AS)	\overline{DS} ↓ to \overline{AS} ↓ Delay	50		25		
21	Trc	Valid Access Recovery Time	1000		650		3
22	TdPM(INT)	Pattern Match to \overline{INT} Delay (Bit Port)		1 + 800		1 + 800	6
23	TdACK(INT)	\overline{ACKIN} to \overline{INT} Delay (Port with Handshake)		4 + 600		4 + 600	4,6
24	TdCI(INT)	Counter Input to \overline{INT} Delay (Counter Mode)		1 + 700		1 + 700	6
25	TdPC(INT)	PCLK to \overline{INT} Delay (Timer Mode)		1 + 700		1 + 700	6
26	TdAS(INT)	\overline{AS} to \overline{INT} Delay		300			
27	TsIA(AS)	\overline{INTACK} to \overline{AS} ↑ Setup Time	0		0		
28	ThIA(AS)	\overline{INTACK} to \overline{AS} ↑ Hold Time	250		250		
29	TsAS(DSA)	\overline{AS} ↑ to \overline{DS} (Acknowledge) ↓ Setup Time	350		250		5
30	TdDSA(DR)	\overline{DS} (Acknowledge) ↓ to Read Data Valid Delay		250		180	
31	TwDSA	\overline{DS} (Acknowledge) Low Width	390		250		
32	TdAS(IEO)	\overline{AS} ↑ to IEO ↓ Delay (\overline{INTACK} Cycle)		350		250	5
33	TdIEI(IEO)	IEI to IEO Delay		150		100	5
34	TsIEI(DSA)	IEO to \overline{DS} (Acknowledge) ↓ Setup Time	100		70		5
35	ThIEI(DSA)	IEI to \overline{DS} (Acknowledge) ↓ Hold Time	100		70		
36	TdDSA(INT)	\overline{DS} (Acknowledge) ↓ to \overline{INT} ↓ Delay		600		600	

NOTES:

- Parameter does not apply to Interrupt Acknowledge transactions.
- Float delay is measured to the time when the output has changed 0.5 V from steady state with minimum ac load and maximum dc load.
- This is the delay from \overline{DS} ↓ of one CIO access to \overline{DS} ↓ of another CIO access.
- The delay is from DAV ↑ for 3-Wire Input Handshake. The delay is from DAC ↓ for 3-Wire Output Handshake. One additional AS cycle is required for ports in the Single Buffered mode.

- The parameters for the devices in any particular daisy chain must meet the following constraint: the delay from \overline{AS} ↑ to \overline{DS} ↓ must be greater than the sum of TdAS(IEO) for the highest priority peripheral, TsIEI(DSA) for the lowest priority peripheral, and TdIEI(IEO) for each peripheral separating them in the chain.

6. Units equal to AS cycle + ns.

* Timings are preliminary and subject to change.

† Units in nanoseconds(ns), except as noted.

- The AS functions as the clock to the 8036. If AS strobe stops, then data does not get clocked through the device. AS cycle functions similar to a clock cycle, following AS timing specifications. Refer to 7-1 of the Technical Manual.

Interlocked Handshake

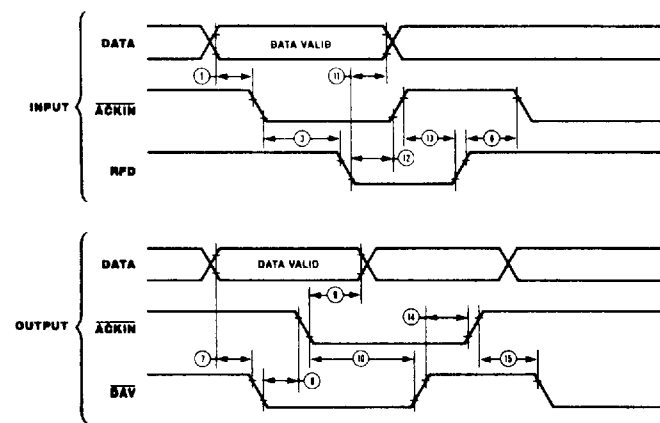
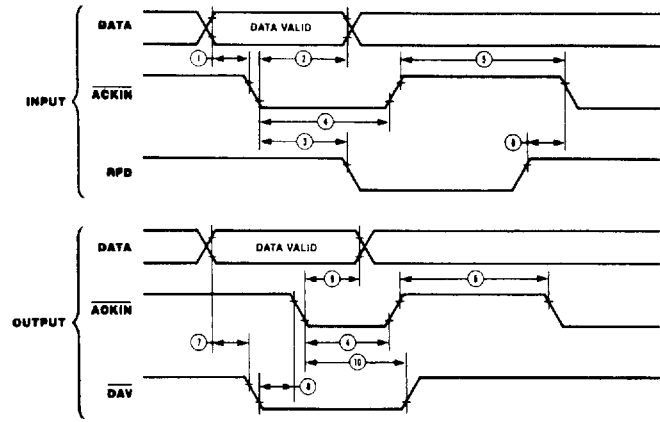

3-Wire Handshake

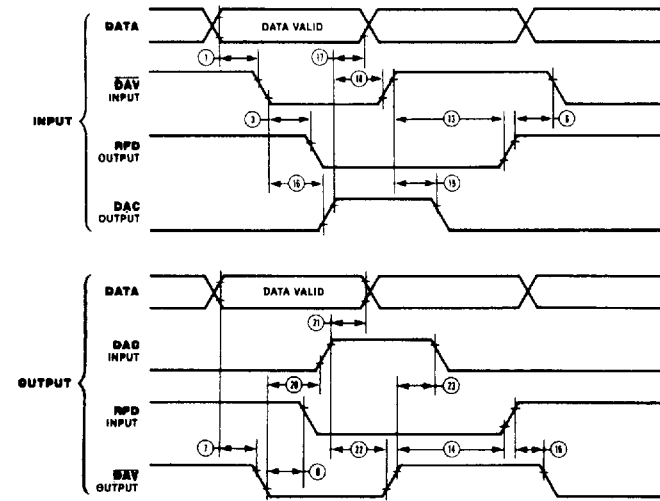

No.	Symbol	Parameter	4 MHz		6 MHz		Notes*†
			Min	Max	Min	Max	
1	TsDI(ACK)	Data Input to $\overline{\text{ACKIN}}$ ↓ Setup Time	0		0		
2	ThDI(ACK)	Data Input to $\overline{\text{ACKIN}}$ ↓ Hold Time - Strobed Handshake	500		330		
3	TdACKI(RFD)	$\overline{\text{ACKIN}}$ ↓ to RFD ↓ Delay	0		0		
4	TwACKl	$\overline{\text{ACKIN}}$ Low Width - Strobed Handshake	250		165		
5	TwACKh	$\overline{\text{ACKIN}}$ High Width - Strobed Handshake	250		165		
6	TdRFDr(ACK)	RFD ↓ to $\overline{\text{ACKIN}}$ ↓ Delay	0		0		
7	TsDO(DAV)	Data Out to $\overline{\text{DAV}}$ ↓ Setup Time	25		20		1
8	TdDAVI(ACK)	$\overline{\text{DAV}}$ ↓ to $\overline{\text{ACKIN}}$ ↓ Delay	0		0		
9	ThDO(ACK)	Data Out to $\overline{\text{ACKIN}}$ ↓ Hold Time	1		1		2
10	TdACK(DAV)	$\overline{\text{ACKIN}}$ ↓ to $\overline{\text{DAV}}$ ↓ Delay	1		1		2
11	ThDI(RFD)	Data Input to RFD ↓ Hold Time - Interlocked Handshake	0		0		
12	TdRFDI(ACK)	RFD ↓ to $\overline{\text{ACKIN}}$ ↓ Delay - Interlocked Handshake	0		0		
13	TdACKr(RFD)	$\overline{\text{ACKIN}}$ ↑ ($\overline{\text{DAV}}$ ↑) to RFD ↑ Delay - Interlocked and 3-Wire Handshake	0		0		
14	TdDAVr(ACK)	$\overline{\text{DAV}}$ ↑ to $\overline{\text{ACKIN}}$ ↑ (RFD ↑) - Interlocked and 3-Wire Handshake	0		0		
15	TdACK(DAV)	$\overline{\text{ACKIN}}$ ↑ (RFD ↑) to $\overline{\text{DAV}}$ ↓ Delay - Interlocked and 3-Wire Handshake	0		0		
16	TdDAVI(DAC)	$\overline{\text{DAV}}$ ↓ to DAC ↑ Delay - Input 3-Wire Handshake	0		0		
17	ThDI(DAC)	Data Input to DAC ↑ Hold Time - 3-Wire Handshake	0		0		
18	TdDACOr(DAV)	DAC ↑ to $\overline{\text{DAV}}$ ↓ Delay - Input 3-Wire Handshake	0		0		
19	TdDAVIr(DAC)	$\overline{\text{DAV}}$ ↑ to DAC ↓ Delay - Input 3-Wire Handshake	0		0		
20	TdDAVo(DAC)	$\overline{\text{DAV}}$ ↓ to DAC ↑ Delay - Output 3-Wire Handshake	0		0		
21	ThDO(DAC)	Data Output to DAC ↑ Hold Time - 3-Wire Handshake	1		1		2
22	TdDAVIr(DAV)	DAC ↑ to $\overline{\text{DAV}}$ ↓ Delay - Output 3-Wire Handshake	1		1		2
23	TdDAVo(DAC)	$\overline{\text{DAV}}$ ↑ to DAC ↓ Delay - Output 3-Wire Handshake	0		0		

NOTES:

1. This time can be extended through the use of the deskew timers.
2. Units equal to $\overline{\text{AS}}$ cycle.

* Timings are preliminary and subject to change. All timing references assume 2.0 V for a logic "1" and 0.8 V for a logic "0".
† Units in nanoseconds (ns), except as noted.

**Counter/
Timer
Timing**

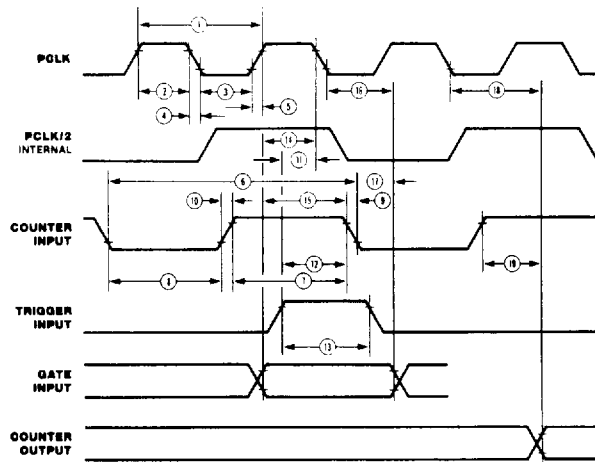

1

No.	Symbol	Parameter	4 MHz		6 MHz		Notes*†
			Min	Max	Min	Max	
1	TcPC	PCLK Cycle Time	250	4000	165	4000	1
2	TwPCh	PCLK High Width	105	2000	70	2000	
3	TwPCl	PCLK Low Width	105	2000	70	2000	
4	TfPC	PCLK Fall Time		20		10	
5	TrPC	PCLK Rise Time		20		10	
6	TcCI	Counter Input Cycle Time	500		330		
7	TCIh	Counter Input High Width	230		150		
8	TwCIl	Counter Input Low Width	230		150		
9	TfCI	Counter Input Fall Time		20		15	
10	TrCI	Counter Input Rise Time		20		15	
11	TsTI(PC)	Trigger Input to PCLK ↓ Setup Time (Timer Mode)	150		120		2
12	TsTI(CI)	Trigger Input to Counter Input ↓ Setup Time (Counter Mode)	150		100		2
13	TwTI	Trigger Input Pulse Width (High or Low)	200		130		
14	TsGI(PC)	Gate Input to PCLK ↓ Setup Time (Timer Mode)	100		100		2
15	TsGI(CI)	Gate Input to Counter Input ↓ Setup Time (Counter Mode)	100		80		2
16	ThGI(PC)	Gate Input to PCLK ↓ Hold Time (Timer Mode)	100		70		2
17	ThGI(CI)	Gate Input to Counter Input ↓ Hold Time (Counter Mode)	100		70		2
18	TdPC(CO)	PCLK to Counter Output Delay (Timer Mode)		475		320	
19	TdCI(CO)	Counter Input to Counter Output Delay (Counter Mode)		475		420	

NOTES:

- PCLK is only used with the counter/timers (in Timer mode), the deskew timers, and the REQUEST/WAIT logic. If these functions are not used, the PCLK input can be held low.
- These parameters must be met to guarantee that trigger or gate

are valid for the next counter/timer cycle.
 * Timings are preliminary and subject to change. All timing references assume 2.0 V for a logic "1" and 0.8 V for a logic "0".
 † Units in nanoseconds (ns).

**REQUEST/
WAIT
Timing**

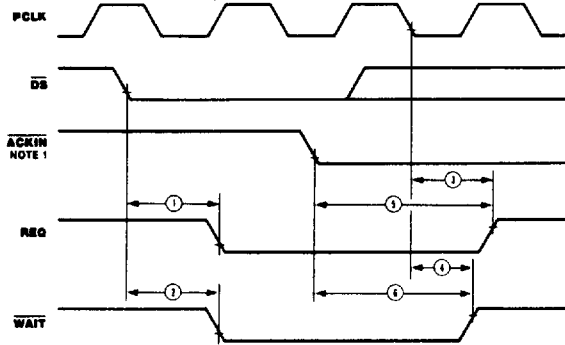

No.	Symbol	Parameter	4 MHz		6 MHz		Notes*†
			Min	Max	Min	Max	
1	TdDS(REQ)	$\overline{DS} \downarrow$ to REQ \downarrow Delay		500		450	
2	TdDS(WAIT)	$\overline{DS} \downarrow$ to WAIT \downarrow Delay		500		450	
3	TdPC(REQ)	PCLK \downarrow to REQ \downarrow Delay		300		320	
4	TdPC(WAIT)	PCLK \downarrow to WAIT \downarrow Delay		300		300	
5	TdACK(REQ)	ACKIN \downarrow to REQ \downarrow Delay		3+2 +1000		3+2 +900	1,2
6	TdACK(WAIT)	ACKIN \downarrow to WAIT \downarrow Delay		10+600		10+500	3

NOTES:

1. The Delay is from DAV \uparrow for the 3-Wire Input Handshake. The delay is from DAC \uparrow for the 3-Wire Output Handshake.
2. Units equal to AS cycles + PCLK cycles + ns.

3. Units equal to PCLK cycles + ns.

* Timings are preliminary and subject to change. All timing references assume 2.0 V for a logic "1" and 0.8 V for a logic "0".

† Units in nanoseconds (ns), except as noted.

**Reset
Timing**

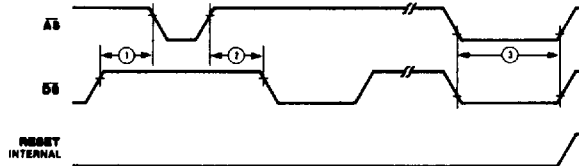

No.	Symbol	Parameter	4 MHz		6 MHz		Notes*†
			Min	Max	Min	Max	
1	TdDSQ(AS)	Delay from $\overline{DS} \downarrow$ to $\overline{AS} \downarrow$ for No Reset	40		15		
2	TdASQ(DS)	Delay from $\overline{AS} \downarrow$ to $\overline{DS} \downarrow$ for No Reset	50		30		
3	TwRES	Minimum Width of \overline{AS} and \overline{DS} both Low for Reset	250		170		1

NOTES:

1. Internal circuitry allows for the reset provided by the Z8 (\overline{DS} held Low while \overline{AS} pulses) to be sufficient.

* Timings are preliminary and subject to change. All timing references assume 2.0 V for a logic "1" and 0.8 V for a logic "0".

† Units in nanoseconds (ns).

Miscellaneous Port Timing

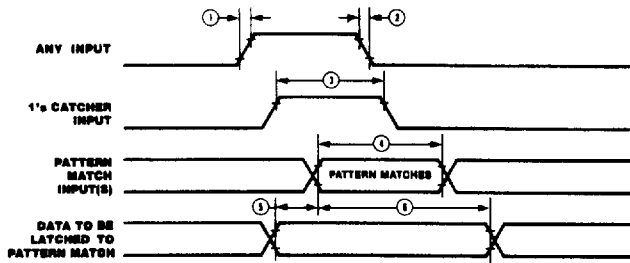

No.	Symbol	Parameter	4 MHz		6 MHz		Notes††
			Min	Max	Min	Max	
1	TrI	Any Input Rise Time		100		100	
2	TfI	Any Input Fall Time		100		100	
3	Tw1's	1's Catcher High Width	250		170		1
4	TwPM	Pattern Match Input Valid (Bit Port)	750		500		
5	TsPMD	Data Latched on Pattern Match Setup Time (Bit Port)	0		0		
6	ThPMD	Data Latched on Pattern Match Hold Time (Bit Port)	1000		650		

NOTES:

1. If the input is programmed inverting, a Low-going pulse of the same width will be detected.

* Timings are preliminary and subject to change. All timing references assume 2.0 V for a logic "1" and 0.8 V for a logic "0".
† Units in nanoseconds (ns).

Bidirectional Port Timing

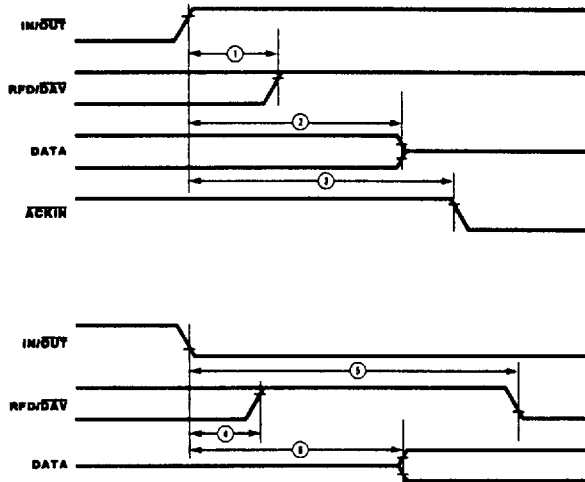

No.	Symbol	Parameter	4 MHz		6 MHz		Notes††
			Min	Max	Min	Max	
1	TdIO _r (DAV)	$\overline{V}\overline{O}$ 1 to RFD/ \overline{DAV} High Delay		500		500	
2	TdIO _r (DRZ)	$\overline{V}\overline{O}$ 1 to Data Float Delay		500		500	
3	TdIO _r (ACK)	$\overline{V}\overline{O}$ 1 to \overline{ACKIN} 1 Delay					2
4	TdIO _r (RFD)	$\overline{V}\overline{O}$ 1 to RFD/ \overline{DAV} High Delay		500		500	
5	TdIO _i (DAV)	$\overline{V}\overline{O}$ 1 to RFD/ \overline{DAV} 1 Delay	3		3		1
6	TdDO(IO)	$\overline{V}\overline{O}$ 1 to Data Bus Driven	2		2		1

NOTES:

1. Units equal to \overline{AS} cycles.
2. Minimum delay is four \overline{AS} cycles or one \overline{AS} cycle after the corresponding IP is cleared, whichever is longer.

* Timings are preliminary and subject to change. All timing references assume 2.0 V for a logic "1" and 0.8 V for a logic "0".
† Units in nanoseconds (ns).

ORDERING INFORMATION

Z8036 Z-CIO, 4.0 MHz
 40-pin DIP 44-pin LCC
 Z0803604CMB Z0803604LMB

Z8036 Z-CIO, 6.0 MHz
 40-pin DIP 44-pin LCC 44-pin PCC
 Z0803606PSC Z0803606LME Z0803606VSC
 Z0803606DSE Z0803606LMB
 Z0803606DEA
 Z0803606CME
 Z0803606CMB

Codes

PACKAGE

Preferred
 D = Cerdip
 P = Plastic
 V = Plastic Chip Carrier

Longer Lead Time

C = Ceramic
 F = Plastic Quad Flat Pack
 G = Ceramic PGA (Pin Grid Array)
 L = Ceramic LCC
 Q = Ceramic Quad-in-Line
 R = Protopack
 T = Low Profile Protopack

TEMPERATURE

Preferred
 S = 0°C to +70°C

Longer Lead Time

E = -40°C to +100°C
 M = -55°C to +125°C

ENVIRONMENTAL

Preferred
 C = Plastic Standard
 E = Hermetic Standard
 F = Protopack Standard

Longer Lead Time

A = Hermetic Stressed
 B = 833 Class B Military
 D = Plastic Stressed
 J = JAN 38510 Military

Example:

Z0803606PSC is an 8036, 6 MHz, Plastic, 0° C to +70° C, Plastic Standard Flow.

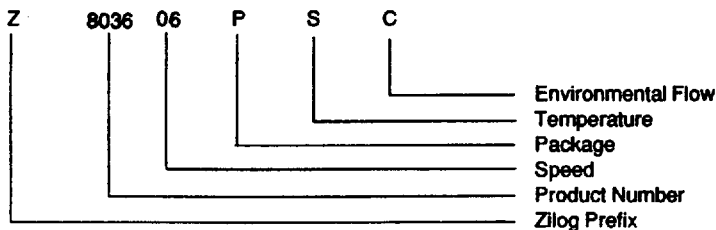

PACKAGE INFORMATION

1

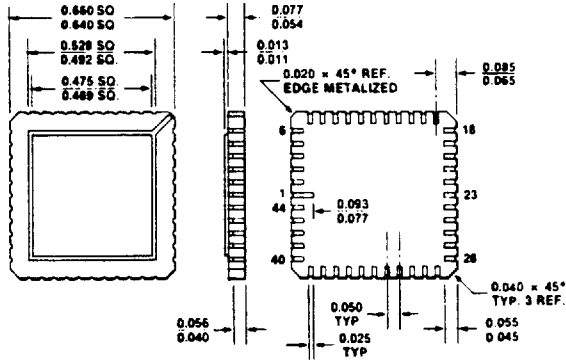

44-Pin Leadless Chip Carrier (LCC),
Ceramic, Jedec Type C

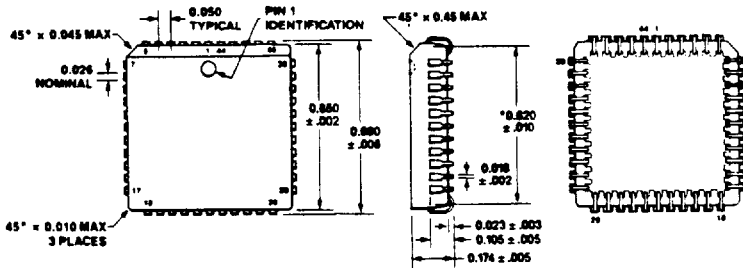

*DIMENSION FROM CENTER TO CENTER OF PINS

View Toward PC Board

Bottom View

44-Pin Plastic Chip Carrier (PCC)

Copyright © Each Manufacturing Company.

All Datasheets cannot be modified without permission.

This datasheet has been download from :

www.AllDataSheet.com

100% Free DataSheet Search Site.

Free Download.

No Register.

Fast Search System.

www.AllDataSheet.com