



# Celeron™ Processor

## Development Kit Manual

---

*July 1999*



Information in this document is provided in connection with Intel products. No license, express or implied, by estoppel or otherwise, to any intellectual property rights is granted by this document. Except as provided in Intel's Terms and Conditions of Sale for such products, Intel assumes no liability whatsoever, and Intel disclaims any express or implied warranty, relating to sale and/or use of Intel products including liability or warranties relating to fitness for a particular purpose, merchantability, or infringement of any patent, copyright or other intellectual property right. Intel products are not intended for use in medical, life saving, or life sustaining applications.

Intel may make changes to specifications and product descriptions at any time, without notice.

Designers must not rely on the absence or characteristics of any features or instructions marked "reserved" or "undefined." Intel reserves these for future definition and shall have no responsibility whatsoever for conflicts or incompatibilities arising from future changes to them.

The Celeron™ processor may contain design defects or errors known as errata which may cause the product to deviate from published specifications. Current characterized errata are available on request.

MPEG is an international standard for video compression/decompression promoted by ISO. Implementations of MPEG CODECs, or MPEG enabled platforms may require licenses from various entities, including Intel Corporation.

Contact your local Intel sales office or your distributor to obtain the latest specifications and before placing your product order.

Copies of documents which have an ordering number and are referenced in this document, or other Intel literature may be obtained by calling 1-800-548-4725 or by visiting Intel's website at <http://www.intel.com>.

Copyright © Intel Corporation, 1999. Portions of this manual Copyright © 1999 General Software, Inc. All rights reserved.

\*Third-party brands and names are the property of their respective owners.



# Contents

---

<b>1</b>	<b>About This Manual</b> .....	1-1
1.1	Content Overview.....	1-1
1.2	Text Conventions.....	1-1
1.3	Technical Support.....	1-2
1.3.1	Electronic Support Systems.....	1-2
1.3.1.1	Online Documents.....	1-2
1.3.1.2	Intel Product Forums.....	1-3
1.3.2	Telephone Technical Support.....	1-3
1.4	Product Literature.....	1-3
1.5	Related Documents.....	1-4
<b>2</b>	<b>Getting Started</b> .....	2-1
2.1	Overview.....	2-1
2.1.1	Processor Assembly Features.....	2-1
2.1.2	Baseboard Features.....	2-2
2.2	Included Hardware.....	2-2
2.3	Software Key Features.....	2-3
2.3.1	General Software, Inc.....	2-3
2.3.2	QNX Software Systems, Ltd.....	2-4
2.4	Before You Begin.....	2-4
2.5	Setting up the Evaluation Board.....	2-5
2.6	Configuring the BIOS.....	2-7
<b>3</b>	<b>Theory of Operation</b> .....	3-1
3.1	Block Diagram.....	3-1
3.2	System Operation.....	3-2
3.2.1	Celeron Processor.....	3-2
3.2.2	82443BX Host Bridge/Controller.....	3-2
3.2.2.1	System Bus Interface.....	3-3
3.2.2.2	Accelerated Graphics Port (AGP) Interface.....	3-3
3.2.2.3	System Clocking.....	3-3
3.2.3	ITP.....	3-3
3.2.4	82371EB PCI to ISA/IDE Xcelerator (PIIX4E).....	3-4
3.2.5	DRAM.....	3-4
3.2.6	Power.....	3-4
3.2.7	Boot ROM.....	3-4
3.2.8	RTC/NVRAM.....	3-4
3.2.9	Legacy I/O.....	3-4
3.2.10	IDE Support.....	3-5
3.2.11	Floppy Disk Support.....	3-5
3.2.12	Keyboard/Mouse.....	3-5
3.2.13	USB.....	3-5
3.2.14	RS232 Ports.....	3-5
3.2.15	IEEE 1284 Parallel Port.....	3-5
3.2.16	PCI Connectors.....	3-5
3.2.17	ISA Connectors.....	3-5
3.2.18	AGP Connector.....	3-5

	3.2.19	Post Code Debugger .....	3-6
	3.2.20	Clock Generation.....	3-6
	3.2.21	Interrupt Map .....	3-6
	3.2.22	Memory Map .....	3-7
<b>4</b>		<b>Hardware Reference .....</b>	<b>4-1</b>
	4.1	Processor Assembly .....	4-1
	4.1.1	Thermal Management .....	4-1
	4.1.2	ITP Debugger Port .....	4-1
	4.2	Post Code Debugger.....	4-1
	4.3	ISA and PCI Expansion Slots.....	4-2
	4.4	PCI Device Mapping .....	4-2
	4.5	Connector Pinouts.....	4-3
	4.5.1	ATX Power Connector.....	4-3
	4.5.2	ITP Debugger Connector .....	4-4
	4.5.3	Stacked USB .....	4-4
	4.5.4	Mouse and Keyboard Connectors.....	4-5
	4.5.5	Parallel Port.....	4-5
	4.5.6	Serial Ports.....	4-6
	4.5.7	IDE Connector.....	4-6
	4.5.8	Floppy Drive Connector.....	4-7
	4.5.9	PCI Slot Connector.....	4-8
	4.5.10	ISA Slot Connector.....	4-9
	4.6	AGP Connector .....	4-10
	4.7	Jumpers .....	4-11
	4.7.1	Enable Spread Spectrum Clocking (J14) .....	4-11
	4.7.2	Clock Frequency Selection (J15) .....	4-11
	4.7.3	On/Off (J20).....	4-11
	4.7.4	Flash BIOS VPP Select (J21).....	4-12
	4.7.5	Flash BIOS Boot Block Control (J22) .....	4-12
	4.7.6	SMI# Source Control (J23).....	4-12
	4.7.7	CMOS RAM Clear (J24).....	4-12
	4.7.8	Push Button Switches .....	4-12
	4.8	In-Circuit BIOS Update.....	4-13
<b>5</b>		<b>BIOS Quick Reference .....</b>	<b>5-1</b>
	5.1	BIOS and Pre-Boot Features .....	5-1
	5.2	Power-On Self-Test (POST) .....	5-1
	5.3	Setup Screen System .....	5-3
	5.3.1	Basic CMOS Configuration Screen .....	5-3
	5.3.2	Configuring Drive Assignments .....	5-4
	5.3.2.1	Configuring Floppy Drive Types .....	5-4
	5.3.3	Configuring IDE Drive Types.....	5-5
	5.4	Configuring Boot Actions.....	5-6
	5.5	Custom Configuration Setup Screen.....	5-6
	5.6	Shadow Configuration Setup Screen .....	5-7
	5.7	Standard Diagnostics Routines Setup Screen .....	5-8
	5.8	Start System BIOS Debugger Setup Screen .....	5-8
	5.9	Start RS232 Manufacturing Link Setup Screen .....	5-9
	5.10	Manufacturing Mode .....	5-9



5.10.1	Console Redirection .....	5-9
5.10.2	CE-Ready Windows CE Loader .....	5-10
5.10.3	Integrated BIOS Debugger .....	5-10
5.11	Embedded BIOS POST Codes .....	5-12
5.12	Embedded BIOS Beep Codes.....	5-15
<b>A</b>	<b>PLD Code Listing .....</b>	<b>A-1</b>
<b>B</b>	<b>Bill of Materials .....</b>	<b>B-1</b>
<b>C</b>	<b>Schematics .....</b>	<b>C-1</b>
<b>Index</b>	.....	<b>Index-1</b>

## Figures

2-1	Evaluation Board Jumpers and Connectors .....	2-5
3-1	Evaluation Board Block Diagram.....	3-1
5-1	BIOS POST Pre-Boot Environment.....	5-2
5-2	Embedded BIOS Setup Screen Menu.....	5-3
5-3	Embedded BIOS Basic Setup Screen.....	5-4
5-4	Embedded BIOS Custom Setup Screen .....	5-7
5-5	Embedded BIOS Shadow Setup Screen.....	5-7
5-6	Standard Diagnostic Routines Setup Screen .....	5-8
5-7	Start RS232 Manufacturing Link Setup Screen.....	5-9
5-8	CE-Ready Boot Feature .....	5-10
5-9	Integrated BIOS Debugger Running Over a Remote Terminal .....	5-11

## Tables

1-1	Related Documents .....	1-4
3-1	Interrupts .....	3-6
3-2	Memory Map .....	3-7
4-1	PCI Device Mapping.....	4-2
4-2	Primary Power Connector (J11) .....	4-3
4-3	ITP Connector Pin Assignment (J2 on the Processor Assembly) .....	4-4
4-4	USB Connector Pinout (J2) .....	4-4
4-5	Keyboard and Mouse Connector Pinouts (J1 on the Baseboard) .....	4-5
4-6	DB25 Parallel Port Connector Pinout (J3).....	4-5
4-7	Serial Port Connector Pinout (J4).....	4-6
4-8	PCI IDE1 (JP3) and IDE2 (JP4) Connector.....	4-6
4-9	Diskette Drive Header Connector (JP1) .....	4-7
4-10	PCI Slots (J7, J8, J9).....	4-8
4-11	ISA Slots (J5, J6).....	4-9
4-12	AGP Slot (J13) .....	4-10
4-13	Default Jumper Settings .....	4-11
5-1	IDE0-IDE3 Drive Assignments .....	5-5
B-1	Baseboard Bill of Materials.....	B-1
B-2	Celeron™ Processor Assembly Bill of Materials .....	B-5



This manual tells you how to set up and use the evaluation board and processor assembly included in your Celeron™ Processor Development Kit.

## 1.1 Content Overview

Chapter 1, “About This Manual” - This chapter contains a description of conventions used in this manual. The last few sections tell you how to obtain literature and contact customer support.

Chapter 2, “Getting Started” - Provides complete instructions on how to configure the evaluation board and processor assembly by setting jumpers, connecting peripherals, providing power, and configuring the BIOS.

Chapter 3, “Theory of Operation” - This chapter provides information on the system design.

Chapter 4, “Hardware Reference” - This chapter provides a description of jumper settings and functions, and pinout information for each connector.

Chapter 5, “BIOS Quick Reference” - This chapter describes how to configure the BIOS for your system configuration. A summary of all BIOS menu options is provided.

Appendix A, “PLD Code Listing” - This appendix includes a sample code listing for the Post Code Debugger.

Appendix B, “Bill of Materials” - This appendix contains the bill of materials for the evaluation board.

Appendix C, “Schematics” - This appendix contains schematics for selected connectors and subsystems for the evaluation board.

## 1.2 Text Conventions

The following notations may be used throughout this manual.

#	The pound symbol (#) appended to a signal name indicates that the signal is active low.
<b>Variables</b>	Variables are shown in italics. Variables must be replaced with correct values.
<b>Instructions</b>	Instruction mnemonics are shown in uppercase. When you are programming, instructions are not case-sensitive. You may use either upper- or lowercase.

<b>Numbers</b>	Hexadecimal numbers are represented by a string of hexadecimal digits followed by the character <i>H</i> . A zero prefix is added to numbers that begin with <i>A</i> through <i>F</i> . (For example, <i>FF</i> is shown as <i>0FFH</i> .) Decimal and binary numbers are represented by their customary notations. (That is, <i>255</i> is a decimal number and <i>1111 1111</i> is a binary number. In some cases, the letter <i>B</i> is added for clarity.)																																		
<b>Units of Measure</b>	The following abbreviations are used to represent units of measure: <table> <tr><td>A</td><td>amps, amperes</td></tr> <tr><td>Gbyte</td><td>gigabytes</td></tr> <tr><td>Kbyte</td><td>kilobytes</td></tr> <tr><td>K<math>\Omega</math></td><td>kilo-ohms</td></tr> <tr><td>mA</td><td>milliamps, milliamperes</td></tr> <tr><td>Mbyte</td><td>megabytes</td></tr> <tr><td>MHz</td><td>megahertz</td></tr> <tr><td>ms</td><td>milliseconds</td></tr> <tr><td>mW</td><td>milliwatts</td></tr> <tr><td>ns</td><td>nanoseconds</td></tr> <tr><td>pF</td><td>picofarads</td></tr> <tr><td>W</td><td>watts</td></tr> <tr><td>V</td><td>volts</td></tr> <tr><td><math>\mu</math>A</td><td>microamps, microamperes</td></tr> <tr><td><math>\mu</math>F</td><td>microfarads</td></tr> <tr><td><math>\mu</math>s</td><td>microseconds</td></tr> <tr><td><math>\mu</math>W</td><td>microwatts</td></tr> </table>	A	amps, amperes	Gbyte	gigabytes	Kbyte	kilobytes	K $\Omega$	kilo-ohms	mA	milliamps, milliamperes	Mbyte	megabytes	MHz	megahertz	ms	milliseconds	mW	milliwatts	ns	nanoseconds	pF	picofarads	W	watts	V	volts	$\mu$ A	microamps, microamperes	$\mu$ F	microfarads	$\mu$ s	microseconds	$\mu$ W	microwatts
A	amps, amperes																																		
Gbyte	gigabytes																																		
Kbyte	kilobytes																																		
K $\Omega$	kilo-ohms																																		
mA	milliamps, milliamperes																																		
Mbyte	megabytes																																		
MHz	megahertz																																		
ms	milliseconds																																		
mW	milliwatts																																		
ns	nanoseconds																																		
pF	picofarads																																		
W	watts																																		
V	volts																																		
$\mu$ A	microamps, microamperes																																		
$\mu$ F	microfarads																																		
$\mu$ s	microseconds																																		
$\mu$ W	microwatts																																		
<b>Signal Names</b>	Signal names are shown in uppercase. When several signals share a common name, an individual signal is represented by the signal name followed by a number, while the group is represented by the signal name followed by a variable ( <i>n</i> ). For example, the lower chip-select signals are named CS0#, CS1#, CS2#, and so on; they are collectively called CS <i>n</i> #. A pound symbol (#) appended to a signal name identifies an active-low signal. Port pins are represented by the port abbreviation, a period, and the pin number (e.g., P1.0).																																		

## 1.3 Technical Support

### 1.3.1 Electronic Support Systems

Intel's site on the World Wide Web (<http://www.intel.com/>) provides up-to-date technical information and product support. This information is available 24 hours per day, 7 days per week, providing technical information whenever you need it.

#### 1.3.1.1 Online Documents

Product documentation is provided online in a variety of web-friendly formats at:

<http://developer.intel.com/design/litcentr/index.htm>



### **1.3.1.2 Intel Product Forums**

Intel provides technical expertise through electronic messaging. With publicly accessible forums, you have all of the benefits of email technical support, with the added benefit of the option of viewing previous messages written by other participants, and providing suggestions and tips that can help others.

Each of Intel's technical support forums is based on a single product or product family. Questions and replies are limited to the topic of the particular forum. Intel also provides several non-technical support related forums.

Complete information on Intel forums is available at:

<http://support.intel.com/newsgroups/index.htm>

### **1.3.2 Telephone Technical Support**

In the U.S. and Canada, technical support representatives are available to answer your questions between 5 a.m. and 5 p.m. PST. You can also fax your questions to us. (Please include your voice telephone number and indicate whether you prefer a response by phone or by fax). Outside the U.S. and Canada, please contact your local distributor.

1-800-628-8686	U.S. and Canada
916-356-7599	U.S. and Canada
916-356-6100 (fax)	U.S. and Canada

## **1.4 Product Literature**

You can order product literature from the following Intel literature centers.

1-800-548-4725	U.S. and Canada
708-296-9333	U.S. (from overseas)
44(0)1793-431155	Europe (U.K.)
44(0)1793-421333	Germany
44(0)1793-421777	France
81(0)120-47-88-32	Japan (fax only)

## 1.5 Related Documents

**Table 1-1. Related Documents**

Document Title	Order Number
<i>Intel® Celeron™ Processor datasheet</i>	243658
<i>Intel® Celeron™ Processor Specification Update</i>	243748
<i>P6 Family of Processors Hardware Developer's Manual</i>	244001
<i>Intel Architecture Software Developer's Manual, Volume 1: Basic Architecture</i>	243190
<i>Intel Architecture Software Developer's Manual, Volume 2: Instruction Set Reference</i>	243191
<i>Intel Architecture Software Developer's Manual, Volume 3: System Programming Guide</i>	243192
<i>Intel® 440BX AGPset: 82443BX Host Bridge/Controller datasheet</i>	290633
<i>Intel® 440BX AGPset: 82443BX Host Bridge/Controller Specification Update</i>	290639
<i>Intel® 440BX AGPset: 82443BX Host Bridge/Controller Timing Specification</i>	273218
<i>82371AB (PIIX4) and 82371EB (PIIX4E) PCI-TO-ISA/IDE Xcelerator datasheet</i>	290562
<i>Intel 82371EB (PIIX4E) Specification Update</i>	290635
<i>Intel 82371AB PCI ISA IDE Xcelerator (PIIX4) Timing Specification</i>	273135

This chapter identifies the Development Kit's key components, features and specifications, and tells you how to set up the board for operation.

## 2.1 Overview

The evaluation board consists of a baseboard and a processor assembly.

- The processor assembly contains an Intel<sup>®</sup> Celeron<sup>™</sup> Processor and an 82443BX Host Bridge/Controller.
- The baseboard contains the 82371EB PCI ISA IDE Xcelerator (PIIX4E) and other system board components and peripheral connectors.

**Warning:** The processor assembly is attached to the baseboard at the factory. Do *not* remove the processor assembly from the baseboard. Intel will not support the processor assembly or the baseboard if any portion of the assembly is removed by the customer.

### 2.1.1 Processor Assembly Features

The processor assembly features are summarized below.

- Celeron Processor in a PPGA package (Socket-370) with 66-MHz system bus frequencies
- Intel 440BX AGPset: 82443BX Host Bridge/Controller
- 66 MHz memory interface: A wide range of DRAM support including:
  - 64-bit memory data interface plus 8 ECC bits and hardware scrubbing
  - 60 ns EDO DRAM and 66 MHz SDRAM support
  - 16 Mbit and 64 Mbit DRAM technologies
- Five PCI masters
  - PCI Specification Rev 2.1 Compliant
- Accelerated Graphics Port (AGP) Support:
  - AGP Interface Specification Revision 1.0 compliant
  - AGP - 66/133 MHz, 3.3-V device support
- Integrated System Power Management support

## 2.1.2 Baseboard Features

The baseboard has these features:

- Flash system BIOS ROM
  - General Software system BIOS
  - In-circuit BIOS upgradability
- Two SDRAM DIMM connectors
- 32-Mbyte SDRAM DIMM included
  - 4 Mbyte x64, 3.3 V, 66 MHz with a CAS latency of 2
- User-accessible on-board connectors include:
  - Two serial RS-232 ports; COM1, COM2
  - One EPP/ECP parallel port
  - PS/2 keyboard and PS/2 mouse (6-pin mini-DIN connectors)
  - Two USB ports
  - Two IDE bus connectors
  - One floppy connector
  - Three PCI expansion slots and two ISA expansion slots. There are no shared slots; all slots are usable.
  - One AGP connector
  - Standard ATX power supply connector
- Miscellaneous features include:
  - On board post-code debugger (Port 80)
  - Reset push button
  - Stand-off feet for table-top operation

## 2.2 Included Hardware

- Evaluation board (baseboard and processor assembly combination)
- 3.2-Gbyte hard disk drive pre-loaded with the QNX Real Time Operating System\*
- 32-Mbyte SDRAM DIMM
- Attached heatsink and fan
- PCI video graphics adapter using the CHIPS\* 69000 HiQVideo\* Accelerator
- Mounting hardware
- IDE cable for the hard disk drive

## 2.3 Software Key Features

The software in the kit was chosen to facilitate development of real-time applications based on the components used in the evaluation board. The software tools included in your kit are described in this section.

**Note:** Software in the kit is provided free by the vendor and is only licensed for evaluation purposes. Customers using the tools that work with Microsoft products must have licensed those products. Any targets created by those tools should also have appropriate licenses. Software included in the kit is subject to change.

### 2.3.1 General Software, Inc.

Embedded BIOS is a full-featured BIOS for x86-based handheld, embedded, and volume consumer electronics applications. This product offers a winning combination of superior OEM configurability and superior embedded features.

Embedded BIOS leads the industry with all the on-target embedded features that OEMs making embedded, handheld, mobile, and consumer electronics demand:

- CE Ready\*, the Windows CE\* launcher
- Integrated BIOS-aware debugger
- Resident Flash Disk disk emulator
- ROM disk and RAM disk emulators
- Manufacturing Mode for in-field diagnosis and software upgrades
- Power management that can operate in an APM or stand-alone environment
- PCI resource management
- Matrix keyboard support
- LCD panel drivers
- Console redirection over RS232 ports
- Flexibility to boot from many disk servers
- OEM-configurable setup screen system
- Embedded DOS\*-ROM (adaptation kit and license)
- Total compatibility with industry standards

## 2.3.2 QNX Software Systems, Ltd.

QNX Real Time Operating System for Intel Architecture.

- Small memory footprint of the QNX operating system with microGUI
- QNX microGUI is a full featured graphical user interface (GUI) and windowing system
- Photon Application Builder
- QNX Development kit provides the basic utilities to build and program Intel Flash
- Watcom C/C++ Development Suite: is a full featured development suite
- Includes compiler, assembler and debugger with full support for the QNX microGUI function library
- Makes development of the QNX executables fast, easy and optimized

**Caution:** Use the shutdown button to exit from QNX. Improper shutdown may result in the loss of the file system.

## 2.4 Before You Begin

Before you set up and configure your evaluation board, you may want to gather some additional hardware and software.

<b>VGA Monitor</b>	You can use any standard VGA or multi-resolution monitor. The setup instructions in this chapter assume that you are using a standard VGA monitor.
<b>Power Supply</b>	You must use an ATX-type PC power supply.
<b>Keyboard</b>	You need a keyboard with a PS/2 style connector or adapter.
<b>Mouse</b>	Optional. You can use a mouse with a PS/2 style connector or adapter.
<b>Additional Drives</b>	You can connect up to four IDE drives and a floppy drive to the evaluation board. Two devices (master and slave) can be attached to each IDE connector. You will need to provide the cables for these drives.  You may have all these storage devices attached to the board at the same time.
<b>Video Adapter</b>	You can use the Chips and Technologies video adapter supplied with your kit, or you can use a different adapter. The evaluation board supports AGP, PCI and ISA video cards. It is up to you to install the correct drivers for video adapters other than the one provided.
<b>Other Devices and Adapters</b>	The evaluation board behaves much like a standard desktop computer motherboard. Most PC compatible peripherals can be attached and configured to work with the evaluation board. For example, you may want to install a sound card or network adapter.

## 2.5 Setting up the Evaluation Board

Once you have gathered the hardware described in the last section, follow the steps below to set up your evaluation board. This manual assumes you are familiar with basic concepts involved with installing and configuring hardware for a personal computer system. Refer to Figure 2-1 for locations of connectors, jumpers, etc.

1. Make sure you are in a static-free environment before removing any components from their anti-static packaging. The evaluation board is susceptible to electro-static discharge damage; such damage may cause product failure or unpredictable operation.
2. Inspect the contents of your kit. Check for damage that may have occurred during shipment. Contact your sales representative if any items are missing or damaged.

**Caution:** Connecting the wrong cable or reversing the cable can damage the evaluation board and may damage the device being connected. Since the board is not in a protective chassis, use caution when connecting cables to this product.

**Figure 2-1. Evaluation Board Jumpers and Connectors**

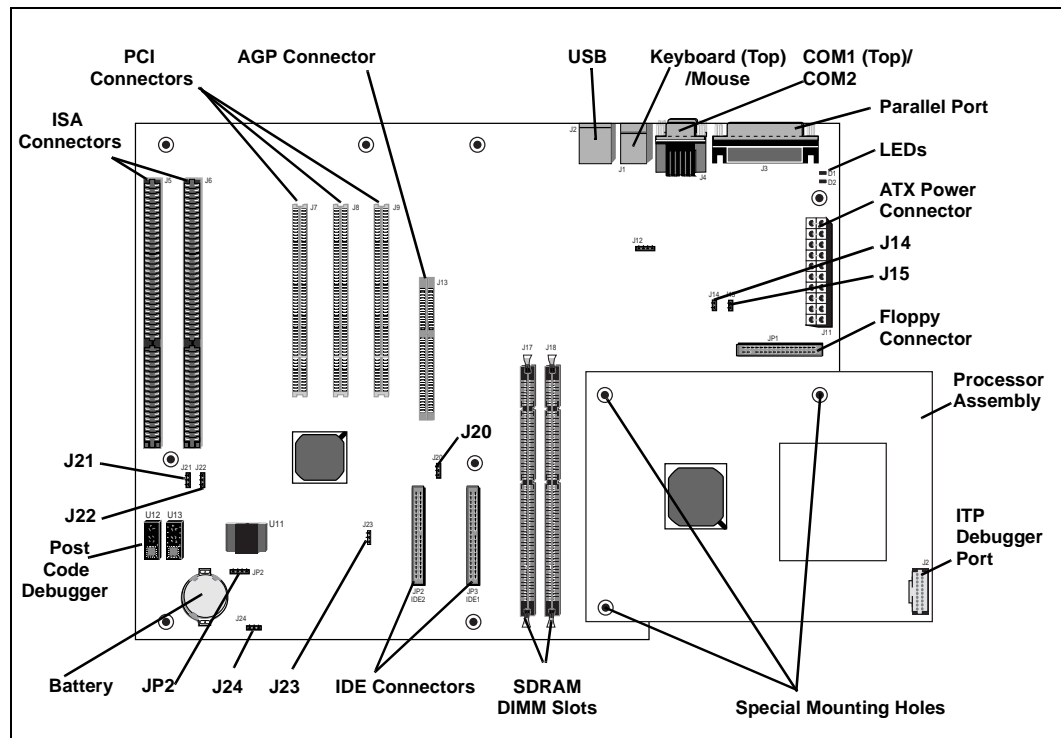

3. Make sure the board's jumpers are set to the following default locations.
  - J14 - Not installed
  - J15 - Installed
  - J20 - Jumper pins 2-3
  - J21 - Jumper pins 2-3
  - J22 - Jumper pins 2-3
  - J23 - Jumper pins 2-3
  - J24 - Jumper pins 1-2
4. Mount the hardware:
  - Table-top operation: The evaluation board is shipped with standoff "feet" for use in a table-top environment. These feet are installed on the evaluation board to raise it off the table surface. Your kit contains two bags of mounting hardware. One bag contains eight standoff feet, eight mounting screws, and eight washers. Another bag has three *shorter* feet that must be attached slightly differently.
    - To mount the eight standard feet, insert a washer onto a screw, then push the screw through the top of the board. From below the board, thread one of the longer feet onto the screw.
    - To mount the three special feet, screw the three *shorter* feet onto the existing screws. See Figure 2-1 for the location of the three special holes.

**Warning:** Do not remove the nuts from these three holes! This will detach the processor assembly from the baseboard, and Intel will no longer support the evaluation board.

- The evaluation board is not ATX compatible.

5. Connect desired storage devices to the evaluation board:

The evaluation board supports Primary and Secondary IDE interfaces that can each host one or two devices (master/slave). When you are using multiple devices, such as a hard disk and a CD-ROM drive, make sure the hard disk drive has a jumper in the master position and the CD-ROM has a jumper in the slave position. When you are using a single IDE device with the evaluation board, be sure that the jumpers set correctly for single master operation. For jumper settings for other configurations, consult the drive's documentation.

**Note:** The evaluation board BIOS only supports hard drives of 16 Gbytes or less.

- Installing the IDE hard disk drive included in your kit:
  - Connect the hard drive's IDE connector to the JP4 connector on the evaluation board. Be sure to align Pin 1 of the cable connector with pin 1 of JP4.
  - Connect the other end to the hard disk drive.

**Caution:** Make sure the tracer on the ribbon cable is aligned with pin 1 on both the hard disk and the IDE connector header. Connecting the cable backwards can damage the evaluation board or the hard disk.

- Connect the hard drive to the power supply.

**Note:** The hard disk is already formatted and is pre-loaded with the QNX Real-Time Operating System for Intel Architecture.



- You may have to make changes to the system BIOS to enable this hard disk. See Chapter 5, “BIOS Quick Reference” for more information.
  - Floppy drive: A floppy disk drive connected to the evaluation board is the most direct method for loading software.
    - Insert floppy cable into JP1 (be sure to orient Pin 1 correctly).
    - Connect the other end of the ribbon cable to the floppy drive.
    - Connect a power cable to the floppy drive.
    - You must make changes to the system BIOS to enable this floppy disk. See Chapter 5, “BIOS Quick Reference” for more information.
  - 6. Make sure the SDRAM DIMM is installed in the socket labeled J18.
  - 7. Connect a PS/2 mouse and keyboard (see Figure 2-1 for connector locations).
- Note:** J1 (on the baseboard) is a stacked PS/2 connector. The *bottom* connector is for the mouse and the *top* is for the keyboard.
- 8. Install the Chips and Technologies PCI video adapter into one of the available PCI slots. Connect the monitor cable to the VGA port on the card.
  - 9. Connect the power supply:
    - You'll need a standard ATX PC power supply. Make sure the power supply is unplugged (or turned off), then connect the power supply cable to the power header (J11).
- Note:** Some ATX power supplies do not have an on/off switch. In this case remove jumper J20 before plugging in the ATX power connector. J20 controls an internal power supply on/off switch. When you are ready to apply power, insert the jumper on pins 2-3. You may want to wire this header up to a toggle switch for convenience.

Turn on the power to the monitor and evaluation board. When the power is on you should see two power-indicator LEDs light up (located next to the ATX power connector in the upper right corner of the board; see Figure 2-1). Check to see that the fan on the processor is operating.

## 2.6 Configuring the BIOS

General Software's BIOS software is pre-loaded on the evaluation board. You will have to make changes to the BIOS to enable hard disks, floppy disks and other supported features. You can use the Setup program to modify BIOS settings and control the special features of the system. Setup options are configured through a menu-driven user interface. Chapter 5, “BIOS Quick Reference” contains a description of BIOS options.

BIOS updates may periodically be posted to Intel's Developers' web site at <http://developer.intel.com/>.



## 3.1 Block Diagram

Figure 3-1. Evaluation Board Block Diagram

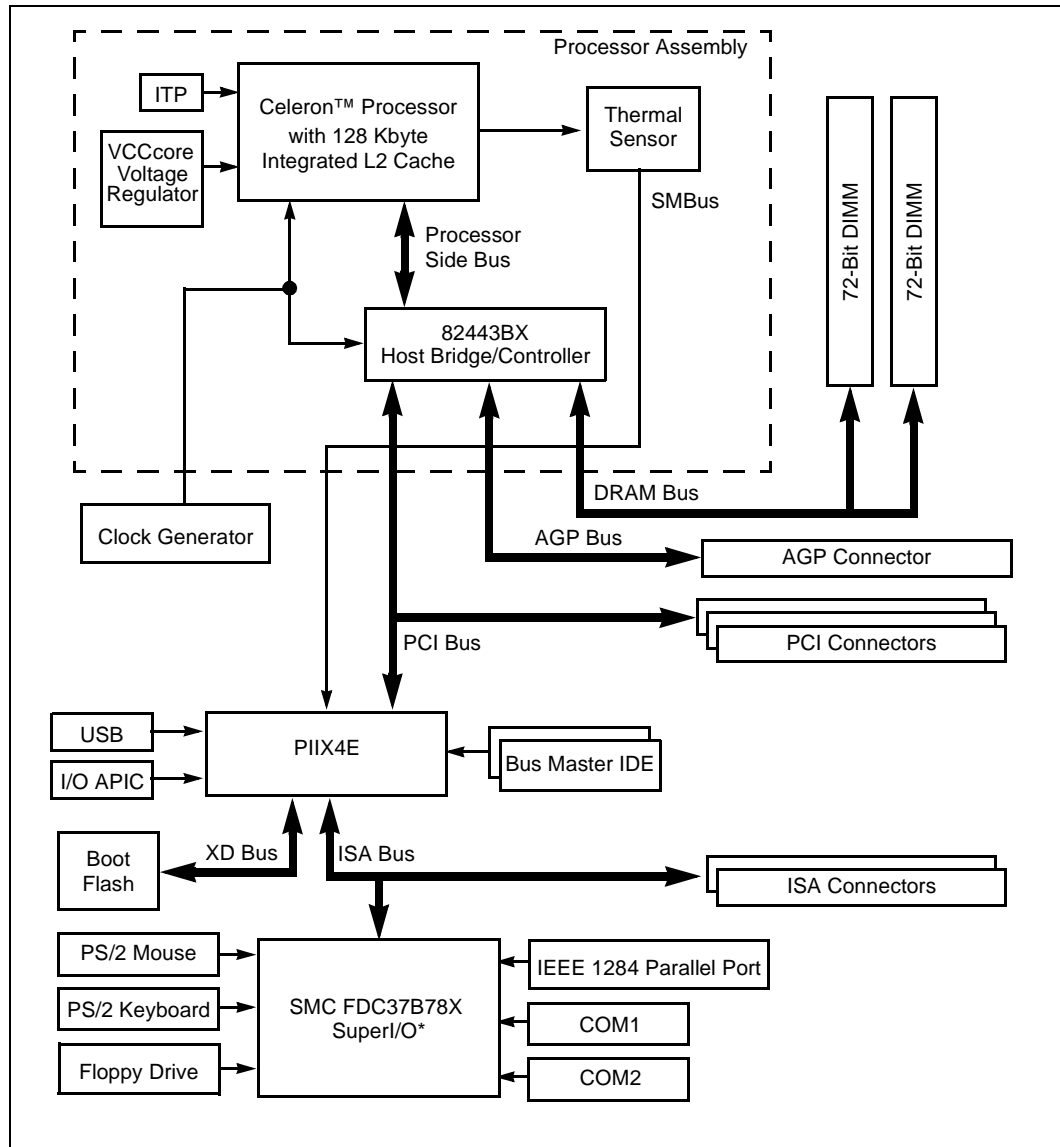

## 3.2 System Operation

The Celeron™ processor evaluation board is a full-featured system board and processor assembly. The processor assembly includes either a 366-MHz or a 433-MHz Celeron processor (based on the development kit purchased) with 128 Kbytes of integrated L2 cache and the Intel 82443 BX Host Bridge/Controller. The evaluation board contains the Intel 82371EB PCI-to-ISA/IDE Xcelerator (PIIX4E) and other system and I/O peripherals.

The evaluation board and processor assembly support 300-MHz, 366-MHz, and 433 MHz Celeron processors with 128 Kbytes of integrated L2 cache. The customer may remove the Celeron processor from the processor *socket* and replace it with another supported version. *Do not remove the processor assembly.* The evaluation board automatically detects which processor is installed in the socket.

### 3.2.1 Celeron Processor

The Celeron processor for applied computing is offered at 366 MHz and 433 MHz with a processor system bus speed of 66 MHz. The Celeron processor consists of a Pentium® II processor core with an integrated second level cache and a 64-bit high-performance host bus. The processor has a private second level cache bus that allows a high-performance 64-bit wide cache subsystem to be integrated on the same die as the processor. The processor can cache up to 4 Gbytes of memory using 128 Kbytes of L2 cache, 16 Kbytes of L1 data cache and 16 Kbytes of L2 code cache. The private first and second level cache operate at the same frequency and voltage as the processor core to improve performance and reduce total system power consumption.

### 3.2.2 82443BX Host Bridge/Controller

The Intel® 440BX AGPset supports the Pentium II processor architecture. It interfaces with the Celeron processor system bus at 66 MHz. Along with its Host-to-PCI bridge interface, the 82443BX Host Bridge/Controller has been optimized with a 66 MHz SDRAM memory controller and data path unit. The 82443BX also features the Accelerated Graphics Port (AGP) interface. The 82443BX component includes the following functions and capabilities:

- 64-bit GTL+ based system data bus interface
- 32-bit system address bus support
- 64/72-bit main memory interface with optimized support for SDRAM
- 32-bit PCI bus interface with integrated PCI arbiter
- AGP interface with up to 133 MHz data transfer capability
- Extensive data buffering between all interfaces for high throughput and concurrent operations

### 3.2.2.1 System Bus Interface

The 82443BX supports a maximum of 4 Gbytes of memory address space from the processor perspective. The largest address size is 32 bits. The 82443BX provides bus control signals and address paths for transfers between the processor bus, PCI bus, Accelerated Graphics Port and main memory. The 82443BX supports a 4-deep-in-order queue, which provides support for pipelining of up to four outstanding transaction requests on the system bus.

For system bus-to-PCI transfers, the addresses are either translated or directly forwarded on the PCI bus, depending on the PCI address space being accessed. When the access is to a PCI configuration space, the processor I/O cycle is mapped to a PCI configuration space cycle. When the access is to a PCI I/O or memory space, the processor address is passed without modification to the PCI bus. Certain memory address ranges are dedicated for a graphics memory address space. When this space or a portion of it is mapped to main DRAM, the address is translated by the AGP address remapping mechanism and the request is forwarded to the DRAM subsystem. A portion of the graphics aperture can be mapped on the AGP, and the corresponding system bus cycles accessing that range are forwarded to the AGP without any translation. The AGP address map defines other system bus cycles that are forwarded to the AGP.

### 3.2.2.2 Accelerated Graphics Port (AGP) Interface

The 82443BX supports an AGP interface. The AGP interface has a maximum theoretical transfer rate of ~532 Mbytes/s.

### 3.2.2.3 System Clocking

The 82443BX operates the system bus interface at 66 MHz, the PCI bus at 33 MHz and the AGP at a transfer rate of 66/133 MHz. The 82443BX clocking scheme uses an external clock synthesizer that produces reference clocks for the system bus and PCI interfaces. The 82443BX generates the AGP and DRAM clock signals. Please refer to the *CK97 Clock Synthesizer/Driver Specification* (order number 243867).

## 3.2.3 ITP

The evaluation board is populated with a 2.5 V ITP debugger port. The ITP port provides a path for debugger tools like emulators, in-target probes, and logic analyzers to gain access to the Celeron processor registers and signals without affecting high speed operation. This allows the system to operate at full speed with the debugger attached.

### 3.2.4 82371EB PCI to ISA/IDE Xcelerator (PIIX4E)

The 82443BX is designed to support the PIIX4E I/O bridge. The PIIX4E is a highly-integrated multifunctional component that supports the following:

- PCI Revision 2.1 compliant PCI-to-ISA bridge with support for 33 MHz PCI operations
- ACPI Power Management support
- Enhanced DMA controller, interrupt controller and timer functions
- Integrated IDE controller with Ultra DMA/33 support
- USB host interface with support for two USB ports
- System Management Bus (SMB) with support for DIMM Serial Presence Detect

### 3.2.5 DRAM

The evaluation board provides two 168-pin DIMM module connectors. The DRAM interface is a 64-bit data path that supports Synchronous DRAM (SDRAM). The DRAM interface supports 4 Mbytes to 256 Mbytes of 4-Mbit, 16-Mbit and 64-Mbit DRAM and SRAM technology (both symmetrical and asymmetrical). Parity is not supported. One 32-Mbyte SDRAM DIMM is included in the kit.

### 3.2.6 Power

The evaluation board uses an industry standard ATX-style power supply with a 20-pin connector. A 230-watt (minimum) supply is recommended. Note that the ATX power connector is keyed to prevent incorrect insertion. See “ATX Power Connector” on page 4-3 for a detailed description of the power connector.

Make sure that the ATX power supply is *not* plugged into the wall when connecting or disconnecting it from the evaluation board.

### 3.2.7 Boot ROM

The system boot ROM installed at U11 is a 2-Mbit 28F002BC flash device. The system is set up for in-circuit reprogramming of the BIOS, but the flash device is also socketed. This device is addressable on the XD bus extension of the ISA bus.

### 3.2.8 RTC/NVRAM

The RTC and NVRAM are contained within the 82371EB PIIX4E device. CMOS NVRAM backup is provided by a 3-V lithium-ion battery.

### 3.2.9 Legacy I/O

Support for legacy I/O functions is provided by the Intel 82371EB PIIX4E and the SMC FDC37B78X SuperI/O\* device.

### 3.2.10 IDE Support

The evaluation board supports both a primary and secondary IDE interface via two 40-pin IDE connectors. The connector labeled IDE1 is the primary interface. IDE2 is the secondary interface.

### 3.2.11 Floppy Disk Support

Floppy disk support is provided by the SMC FDC37B78X SuperI/O device. One 34-pin floppy connector is provided on the evaluation board.

### 3.2.12 Keyboard/Mouse

Keyboard and mouse support are provided by the SMC FDC37B8X SuperI/O device. The keyboard and mouse connectors (J1) are PS/2 style, 6-pin stacked miniature DIN connectors. The top connector is for the keyboard and the bottom connector is for the mouse.

### 3.2.13 USB

USB support is provided through the PIIX4E and can be used through connector J2.

### 3.2.14 RS232 Ports

Two serial I/O ports provided by the SMC FDC37B78X SuperI/O device. Two 9-pin RS232 connectors are provided on a single stacked connector (J4).

### 3.2.15 IEEE 1284 Parallel Port

One 25-pin IEEE 1284 parallel port connector controlled by the SMC FDC37B78X SuperI/O device is provided (J3).

### 3.2.16 PCI Connectors

Three industry standard 32-bit, 5-V PCI connectors are provided on the evaluation board. The connectors are designed to handle either a 5-V only card or a universal card. 3.3-V cards are not supported.

### 3.2.17 ISA Connectors

Two 16-bit ISA connectors are provided on the evaluation board.

### 3.2.18 AGP Connector

AGP support is provided through the 82443BX Host Bridge/Controller. One industry standard AGP connector (J13) is provided on the evaluation board.

### 3.2.19 Post Code Debugger

The evaluation board has an on-board Post Code Debugger. Data from any program that does an I/O write to 0080H is latched and displayed on the two LEDs (U12 and U13). During BIOS startup, codes are posted to these LEDs to indicate what the BIOS is doing. Application programs can post their own data to these LEDs by writing to I/O address 0080H.

### 3.2.20 Clock Generation

There are three devices on the baseboard which generate and distribute the clocks used by the entire system. These are the CY2280 clock synthesizer, CY2318NZ clock buffer and the CY23009 zero delay buffer. Not all of these devices are used on this version of the evaluation board.

The CY2280 generates the clocks for the Celeron processor, Host Bridge/Controller, cache, PCI, USB and ISA bus. The processor clock runs at 66 MHz. The PCI clocks run at 33 MHz. This device is capable of spread spectrum clocking. If spread spectrum clocking is enabled, a 0.5% down spread will be introduced in the processor and PCI clocks.

The CY2318NZ clock buffer is used to buffer the clock signals sent to the SDRAM DIMMS. The SDRAM interface operates at 66 MHz.

The CY2309 Zero Delay Buffer is not used by the evaluation board.

### 3.2.21 Interrupt Map

Table 3-1. Interrupts

IRQ	System Resources
NMI	I/O Channel Check
0	Reserved, Interval Timer
1	Reserved, Keyboard buffer full
2	Reserved, Cascade interrupt from slave PIC
3	Serial Port 2
4	Serial Port 1
5	Parallel Port (PNP0 option)
6	Floppy
7	Parallel Port 1
8	Real Time Clock
9	IRQ2 Redirect
10	Reserved. Not supported.
11	Reserved. Not supported.
12	Onboard Mouse Port if present, else user available
13	Reserved, Math coprocessor
14	Primary IDE if present, else user available
15	Reserved. Not supported.



### 3.2.22 Memory Map

Table 3-2. Memory Map

Address Range (Hex)	Size	Description
100000-8000000	127.25M	Extended Memory
E0000-FFFFFF	128K	BIOS
C8000-DFFFF		Available expansion BIOS area (Flash disk memory window)
A0000-C7FFF		Off-board video memory and BIOS
9FC00-9FFFF	1K	Extended BIOS Data (movable by QEMM, 386MAX)
80000-9FBFF	127K	Extended conventional
00000-7FFFF	512K	Conventional



This section provides reference information on the system design. Included in this section is connector pinout information, jumper settings, and other system design information.

## 4.1 Processor Assembly

The processor assembly contains the Celeron™ processor, the 82443BX Host Bridge/Controller, a voltage regulator and an ITP debugger connector. The assembly connects to the baseboard via a 400-pin connector.

**Warning:** The processor assembly is attached to the baseboard at the factory. Do *not* remove the processor assembly from the baseboard. Intel will not support the processor assembly or the baseboard if any portion of the assembly is removed by the customer.

### 4.1.1 Thermal Management

The objective of thermal management is to ensure that the temperature of each component is maintained within specified functional limits. The functional temperature limit is the range within which the electrical circuits can be expected to meet their specified performance requirements. Operation outside the functional limit can degrade system performance and cause reliability problems.

**Important:** The evaluation kit contains a heatsink and fan attached to the top of the Celeron processor. This thermal solution has been tested in an open air environment at room temperature and is sufficient for *evaluation purposes only*. It is up to the designer to provide adequate thermal management for any designs derived from the schematics provided in your kit.

### 4.1.2 ITP Debugger Port

The evaluation platform is populated with a 2.5 V ITP debugger port. The ITP port provides a path for debugger tools like emulators, in-target probes, and logic analyzers to gain access to the Celeron processor's registers and signals without affecting high speed operation. This allows the system to operate at full speed with the debugger attached.

## 4.2 Post Code Debugger

The evaluation board has an on-board Post Code Debugger. Data from any code that does an I/O write to 80H is latched on the two led displays (U12/U13). During BIOS startup, code is posted to these LEDs to indicate what the BIOS is doing. Application code can post its own data to these LEDs by doing an I/O write to address 80H. The 22V10 PLD code used to implement this function is included in Appendix A, "PLD Code Listing."

## 4.3 ISA and PCI Expansion Slots

The evaluation platform has three PCI expansion slots and two ISA slots.

## 4.4 PCI Device Mapping

On the evaluation platform the PCI devices are mapped to PCI device numbers by connecting an address line to the IDSEL signal of each PCI device. Table 4-1 shows the mapping of PCI devices.

**Table 4-1. PCI Device Mapping**

Device	Address Line	PCI Device Number
PIIX4E	AD18	7
PCI Slot 0 (J7)	AD28	17
PCI Slot 1 (J8)	AD29	18
PCI Slot 2 (J9)	AD30	19

## 4.5 Connector Pinouts

### 4.5.1 ATX Power Connector

Table 4-2 shows the signals assigned to the ATX style power connector.

**Table 4-2. Primary Power Connector (J11)**

Pin	Name	Function
1	3.3 V	3.3 V
2	3.3 V	3.3 V
3	GND	Ground
4	+5V	+5 V VCC
5	GND	Ground
6	+5V	+5 V VCC
7	GND	Ground
8	PWRGD	Power Good
9	5VSB	Standby 5 V
10	+12 V	+12 V
11	3.3 V	3.3 V
12	-12 V	-12 V
13	GND	Ground
14	PS_ON#	Soft-off control
15	GND	Ground
16	GND	Ground
17	GND	Ground
18	-5 V	-5 Volts
19	+5 V	+5 V VCC
20	+5 V	+5 V VCC

## 4.5.2 ITP Debugger Connector

**Table 4-3. ITP Connector Pin Assignment (J2 on the Processor Assembly)**

Pin	Signal	Pin	Signal
1	RESET#	16	PREQ0#
2	GND	17	GND
3	DBRESET#	18	PRDY0#
4	GND	19	GND
5	TCK	20	PREQ1#
6	GND	21	GND
7	TMS	22	PRDY1#
8	TDI	23	GND
9	POWERON	24	PREQ2#
10	TDO	25	GND
11	DBINST#	26	PRDY2#
12	TRST#	27	GND
13	GND	28	PREQ3#
14	BSEN#	29	BCLK
15	GND	30	PRDY3#

## 4.5.3 Stacked USB

P0 is the bottom connector. P1 is on top.

**Table 4-4. USB Connector Pinout (J2)**

Pin	P0 Signals	P1 Signals
1	VCC0	VCC1
2	D0-	D1-
3	D0+	D1+
4	GND0	GND1

## 4.5.4 Mouse and Keyboard Connectors

The keyboard port is on top. The mouse port is on the bottom.

**Table 4-5. Keyboard and Mouse Connector Pinouts (J1 on the Baseboard)**

Pin	Signal Name
1	Data
2	No Connect
3	Ground
4	+5 V (fused)
5	Clock
6	No Connect

## 4.5.5 Parallel Port

**Table 4-6. DB25 Parallel Port Connector Pinout (J3)**

Pin	Signal Name	Pin	Signal Name
1	Strobe#	14	Auto Feed#
2	Data Bit 0	15	Fault#
3	Data Bit 1	16	INIT#
4	Data Bit 2	17	SLCT IN#
5	Data Bit 3	18	Ground
6	Data Bit 4	19	Ground
7	Data Bit 5	20	Ground
8	Data Bit 6	21	Ground
9	Data Bit 7	22	Ground
10	ACK#	23	Ground
11	Busy	24	Ground
12	Paper end	25	Ground
13	SLCT		

## 4.5.6 Serial Ports

COM1 is the top connector. COM2 is the bottom connector.

**Table 4-7. Serial Port Connector Pinout (J4)**

Pin	Signal Name
1	DCD
2	Serial In (SIN)
3	Serial Out (SOUT)
4	DTR
5	GND
6	DSR
7	RTS
8	CTS
9	RI

## 4.5.7 IDE Connector

**Table 4-8. PCI IDE1 (JP3) and IDE2 (JP4) Connector**

Pin	Signal Name	Pin	Signal Name
1	Reset IDE	2	Ground
3	Host Data 7	4	Host Data 8
5	Host Data 6	6	Host Data 9
7	Host Data 5	8	Host Data 10
9	Host Data 4	10	Host Data 11
11	Host Data 3	12	Host Data 12
13	Host Data 2	14	Host Data 13
15	Host Data 1	16	Host Data 14
17	Host Data 0	18	Host Data 15
19	Ground	20	Key
21	DRQ3	22	Ground
23	I/O Write#	24	Ground
25	I/O Read#	26	Ground
27	IOCHRDY	28	BALE
29	DACK3#	30	Ground
31	IRQ14	32	IOCS16#
33	Addr 1	34	Ground
35	Addr 0	36	Addr 2
37	Chip Select 0#	38	Chip Select 1#
39	Activity	40	Ground



## 4.5.8 Floppy Drive Connector

**Table 4-9. Diskette Drive Header Connector (JP1)**

Pin	Signal Name	Pin	Signal Name
1	Ground	2	FDHDIN
3	Ground	4	Reserved
5	Key	6	FDEDIN
7	Ground	8	Index
9	Ground	10	Motor Enable A#
11	Ground	12	Drive Select B#
13	Ground	14	Drive Select A#
15	Ground	16	Motor Enable B#
17	Ground	18	DIR#
19	Ground	20	STEP#
21	Ground	22	Write Data#
23	Ground	24	Write Gate#
25	Ground	26	Track 00#
27	Ground	28	Write Protect#
29	Ground	30	Read Data#
31	Ground	32	Side 1 Select#
33	Ground	34	Diskette Change#

## 4.5.9 PCI Slot Connector

Table 4-10. PCI Slots (J7, J8, J9)

Pin	Signal Name	Pin	Signal Name	Pin	Signal Name	Pin	Signal Name
A1	VCC	B1	- 12V	A32	AD16	B32	AD17
A2	+ 12V	B2	GND	A33	3.3V	B33	CBE2#
A3	VCC	B3	GND	A34	FRAME#	B34	GND
A4	VCC	B4	No Connect	A35	GND	B35	IRDY#
A5	VCC	B5	VCC	A36	TRDY#	B36	3.3 V
A6	PIRQ1#	B6	VCC	A37	GND	B37	DEVSEL#
A7	PIRQ3#	B7	PIRQ2#	A38	STOP#	B38	GND
A8	VCC	B8	PIRQ0	A39	3.3 V	B39	LOCK#
A9	No Connect	B9	PRSNT1B#	A40	SDONE	B40	PERR#
A10	VCC	B10	No Connect	A41	SBO#	B41	3.3 V
A11	No Connect	B11	PRSNT2B#	A42	GND	B42	SERR#
A12	GND	B12	GND	A43	PAR	B43	3.3V
A13	GND	B13	GND	A44	AD15	B44	CBE1#
A14	No Connect	B14	No Connect	A45	3.3V	B45	AD14
A15	RST#	B15	GND	A46	AD13	B46	GND
A16	VCC	B16	PCLK3	A47	AD11	B47	AD12
A17	GNT1#	B17	GND	A48	GND	B48	AD10
A18	GND	B18	REQ#	A49	AD9	B49	GND
A19	Reserved	B19	VCC	A50	KEY	B50	KEY
A20	AD30	B20	AD31	A51	KEY	B51	KEY
A21	3.3V	B21	AD29	A52	CBEO#	B52	AD8
A22	AD28	B22	GND	A53	3.3 V	B53	AD7
A23	AD26	B23	AD27	A54	AD6	B54	3.3 V
A24	GND	B24	AD25	A55	AD4	B55	AD5
A25	AD24	B25	3.3 V	A56	GND	B56	AD3
A26	IDSEL	B26	CBE3#	A57	AD2	B57	GND
A27	3.3V	B27	AD23	A58	AD0	B58	AD1
A28	AD22	B28	GND	A59	VCC	B59	VCC
A29	AD20	B29	AD21	A60	REQ64#	B60	ACK64#
A30	GND	B30	AD19	A61	VCC	B61	VCC
A31	AD18	B31	3.3 V	A62	VCC	B62	VCC

## 4.5.10 ISA Slot Connector

Table 4-11. ISA Slots (J5, J6)

Pin	Signal Name	Pin	Signal Name	Pin	Signal Name	Pin	Signal Name
A1	IOCHK#	B1	GND	A26	SA5	B26	DACK2#
A2	SD7	B2	RSTSLOT	A27	SA4	B27	TC
A3	SD6	B3	VCC	A28	SA3	B28	BALE
A4	SD5	B4	IRQB9	A29	SA2	B29	VCC
A5	SD4	B5	-5V	A30	SA1	B30	OSC
A6	SD3	B6	DREQ2	A31	SA0	B31	GND
A7	SD2	B7	-12V	C1	SBHE#	D1	MEMCS16#
A8	SD1	B8	ZEROWS#	C2	LA23	D2	IOCS16#
A9	SD0	B9	+12V	C3	LA22	D3	IRQB10
A10	IOCHRDY	B10	GND	C4	LA21	D4	IRQB11
A11	AEN	B11	SMEMW#	C5	LA20	D5	IRQB11
A12	SA19	B12	SMEMR#	C6	LA19	D6	IRQ15
A13	SA18	B13	IOW#	C7	LA18	D7	IRQ14
A14	SA17	B14	IOR#	C8	LA17	D8	DACK0
A15	SA16	B15	DACK3#	C9	MEMR#	D9	DREQ0
A16	SA15	B16	DREQ3	C10	MEMW#	D10	DACK5
A17	SA14	B17	DACK1#	C11	SD8	D11	DREQ5
A18	SA13	B18	DREQ1	C12	SD9	D12	DACK6#
A19	SA12	B19	REFRESH#	C13	SD10	D13	DREQ6
A20	SA11	B20	SYSCLK	C14	SD11	D14	DACK7#
A21	SA10	B21	IRQA7	C15	SD12	D15	DREQ7#
A22	SA9	B22	IRQA6	C16	SD13	D16	VCC
A23	SA8	B23	IRQA5	C17	SD14	D17	MASTER#
A24	SA7	B24	IRQA4	C18	SD15	D18	GND
A25	SA6	B25	IRQA3				

## 4.6 AGP Connector

Table 4-12. AGP Slot (J13)

Pin#	B	A	Pin#	B	A
1	OVRCNT#	12V	34	Vddq3.3	Vddq3.3
2	5.0V	TYPEDET#	35	AD21	AD22
3	5.0V	Reserved	36	AD19	AD20
4	USB+	USB-	37	GND	GND
5	GND	GND	38	AD17	AD18
6	INTB#	INTA#	39	C/BE2#	AD16
7	CLK	RST#	40	Vddq3.3	Vddq3.3
8	REQ#	GNT#	41	IRDY#	FRAME#
9	VCC3.3	VCC3.3	42	3.3Vaux	Reserved
10	ST0	ST1	43	GND	GND
11	ST2	Reserved	44	Reserved	Reserved
12	RBF#	PIPE#	45	VCC3.3	VCC3.3
13	GND	GND	46	DEVSEL#	TRDY#
14	Reserved	Reserved	47	Vddq3.3	STOP#
15	SBA0	SBA1	48	PERR#	PME#
16	VCC3.3	VCC3.3	49	GND	GND
17	SBA2	SBA3	50	SERR#	PAR
18	SB_STB	Reserved	51	C/BE1#	AD15
19	GND	GND	52	Vddq3.3	Vddq3.3
20	SBA4	SBA5	53	AD14	AD13
21	SBA6	SBA7	54	AD12	AD11
22	KEY	KEY	55	GND	GND
23	KEY	KEY	56	AD10	AD9
24	KEY	KEY	57	AD8	C/BE0#
25	KEY	KEY	58	Vddq3.3	Vddq3.3
26	AD31	AD30	59	AD_STB0	Reserved
27	AD29	AD28	60	AD7	AD6
28	VCC3.3	VCC3.3	61	GND	GND
29	AD27	AD26	62	AD5	AD4
30	AD25	AD24	63	AD3	AD2
31	GND	GND	64	Vddq3.3	Vddq3.3
32	AD_STB1	Reserved	65	AD1	AD0
33	AD23	C/BE3#	66	Reserved	Reserved

**NOTES:**

1. Reserved pins are only for future use by the AGP interface specification.
2. IDSEL# is not a pin on the AGP connector. AGP graphics components should connect the AD16 signal to the 3.3 volt IDSEL# function internal to the component.
3. All 3.3 volt cards leave the TYPEDET signal open. All 1.5 volt cards tie this signal hard to ground.

## 4.7 Jumpers

Table 4-13 shows default Jumper settings.

**Table 4-13. Default Jumper Settings**

Jumper	Function	Settings
J14	Enable Spread Spectrum Clocking	In – Enable Spread Spectrum Out – Disable Spread Spectrum (Default)
J15	Clock Frequency Selection	In – 66 MHz Processor Clock (Default) Out – Reserved
J20	On/Off	1–2 Reserved 2–3 On (Default) No Jumper Installed – Off
J21	Flash BIOS VPP Select	1–2 12 V 2–3 5 V (Default)
J22	Flash BIOS boot block control	1–2 12 V 2–3 5 V (Default)
J23	SMI# Source	1–2 SMI# controlled by IOAPIC 2–3 SMI# controlled by PIIX4E (Default)
J24	CMOS RAM Clear	1–2 Normal Operation (Default) 2–3 Clear CMOS RAM

### 4.7.1 Enable Spread Spectrum Clocking (J14)

This jumper is used to enable or disable spread spectrum clocking on the clock synthesizer. When this jumper is in, a 0.5% down spread will be introduced into the PCI and processor clocks. The default setting is no jumper installed, which disables spread spectrum clocking.

### 4.7.2 Clock Frequency Selection (J15)

This jumper controls the frequency of the processor clock. When the jumper is in, 66 MHz operation is supported. This is the only setting supported by this evaluation kit.

**Caution:** Leave this jumper installed. When the jumper is out, 100 MHz processor clocks will be generated. This position is not supported and may cause damage to the processor.

### 4.7.3 On/Off (J20)

This jumper is used to control the state of the ATX power supply. When this jumper is removed, the power supply will be turned off. Placing the jumper in the 2-3 position will turn the power supply on.

The 1-2 position is reserved and should not be used.

#### 4.7.4 Flash BIOS VPP Select (J21)

This jumper controls the voltage presented to the flash BIOS VPP pin. The 2-3 position supplies 5 V and is the default for normal operation. This position inhibits programming or erasing the flash BIOS.

The 1-2 position supplies 12 V and should only be used if directed to do so by a utility that is used to reprogram the BIOS.

#### 4.7.5 Flash BIOS Boot Block Control (J22)

This jumper controls the Boot Block protection of the flash BIOS. When this jumper is in the 2-3 position, the boot block is locked and cannot be programmed. This is the default position of this jumper.

The 1-2 position unlocks the boot block so that it can be erased and reprogrammed. This position should only be used under the direction of a utility that is designed to reprogram the boot block of the flash device.

#### 4.7.6 SMI# Source Control (J23)

This jumper selects the source of the SMI# interrupt to the processor. Only the 2-3 position which selects the PIIX4E is supported. The 1-2 position is reserved for future use.

#### 4.7.7 CMOS RAM Clear (J24)

This jumper controls power to the battery backed-up CMOS RAM. This RAM is used to store information about the system configuration that is required by the BIOS. The 1-2 position is for normal operation. The 2-3 position allows for the RAM to be cleared.

To clear the RAM perform the following steps:

1. Remove power from the evaluation platform by removing jumper J20
2. Move J24 to the 2-3.
3. Disconnect the power supply (J11).
4. Install J24 in the 1-2 position.
5. Reconnect the power supply (J11).
6. Reboot the system and enter the BIOS setup screen to configure the system.

#### 4.7.8 Push Button Switches

There are two push button switches on the evaluation board labeled S1 and S2.

- S1 is non-functional and reserved for future use.
- S2 is the reset button. Press S2 to force a hardware reset of the system.

## 4.8 In-Circuit BIOS Update

The BIOS can be upgraded in-circuit. BIOS updates may periodically be posted to Intel's Developers' site at <http://www.intel.com/design/>.

To reprogram the BIOS:

1. Set Jumper J21 and Jumper J22 to the 1-2 position on the evaluation platform.
2. Download the new BIOS upgrade file from Intel's Developers' web site.
3. Extract the BIOS upgrade zip file onto a bootable floppy.
4. Insert the floppy disk into the floppy drive attached to the evaluation board.
5. Reboot the evaluation board so that it boots from the floppy.
6. Follow the on-screen instructions.
7. When the BIOS update program is finished, power down the board and reset the jumpers at J21 and J22 to the 2-3 position.





The Celeron processor evaluation board is licensed with a single copy of Embedded BIOS and Embedded DOS software from General Software, Inc.<sup>1</sup> This software is provided for demonstration purposes only and must be licensed directly from General Software, Inc. for integration with new designs. General Software may be reached at (800) 850-5755, on the web at <http://www.gensw.com>, or via email at [sales@gensw.com](mailto:sales@gensw.com).

BIOS updates may periodically be posted to the Intel Developers' web site at <http://developer.intel.com/>.

## 5.1 BIOS and Pre-Boot Features

The system's pre-boot environment is managed with an adaptation of Embedded BIOS from General Software. The pre-boot environment includes POST, Setup Screen System, Manufacturing Mode, Console Redirection, Windows CE Loader (CE Ready), and Integrated BIOS Debugger. A REFLASH tool is also available to update the BIOS image with new builds of Embedded BIOS that may be obtained from General Software.

Before using the system, please read the following to properly configure CMOS settings, and learn how to use the embedded features of the pre-boot firmware, Embedded BIOS.

The last two sections of this chapter provide the BIOS POST Codes and Beep codes.

## 5.2 Power-On Self-Test (POST)

When the system is powered on, Embedded BIOS tests and initializes the hardware and programs the chipset and other peripheral components. During this time, POST progress codes are written by the system BIOS to I/O port 80H, allowing the user to monitor the progress with a special monitor. "Embedded BIOS POST Codes" on page 5-12 lists the POST codes and their meanings.

During early POST, no video is available to display error messages should a critical error be encountered; therefore, POST uses beeps on the speaker to indicate the failure of a critical system component during this time. Consult "Embedded BIOS Beep Codes" on page 5-15 for a list of Beep codes used by the system's BIOS.

POST displays its progress on the system video device, which may be the video screen if a VGA card is used, or on a terminal emulation program's screen if output is redirected over a serial port.

---

1. General Software™, the GS Logo, Embedded BIOS™, BIOSStart™, CE-Ready™, and Embedded DOS™ are trademarks or registered trademarks of General Software, Inc.

**Figure 5-1. BIOS POST Pre-Boot Environment**

```
General Software Pentium Embedded BIOS (tm) Version 4.2
Copyright (C) 1999 General Software, Inc.
Low Power Pentium(R) Processor with MMX(tm) Technology Evaluation Platform
Demonstration Copy - Visit General Software at http://www.gensw.com.

00000640K Low Memory Passed
00013184K Ext Memory Passed
Hit <Del> if you want to run SETUP.

For BIOS licensing, call (800) 850-5755 or email sales@gensw.com.
(C) 1999 General Software, Inc.
Pentium-4.2-6E69-6A4E
```

When the system is powered on for the first time, you'll need to configure the system through the Setup Screen System (described later) before peripherals, such as disk drives, are recognized by the BIOS. The information is written to battery-backed CMOS RAM on the board's Real Time Clock. Should the board's battery fail, this information will be lost and the board will need to be reconfigured.

OEMs can modify the look-and-feel of POST with the Embedded BIOS adaptation kit. While the demonstration BIOS looks and feels like a desktop PC, it is possible to eliminate messages, sounds, delays, to make the POST effectively invisible.

## 5.3 Setup Screen System

The system is configured from within the Setup Screen System, which is a series of menus that can be invoked from POST by pressing the <DEL> key if the main keyboard is being used, or by pressing ^C if the console is being redirected to a terminal program.

Figure 5-2. Embedded BIOS Setup Screen Menu

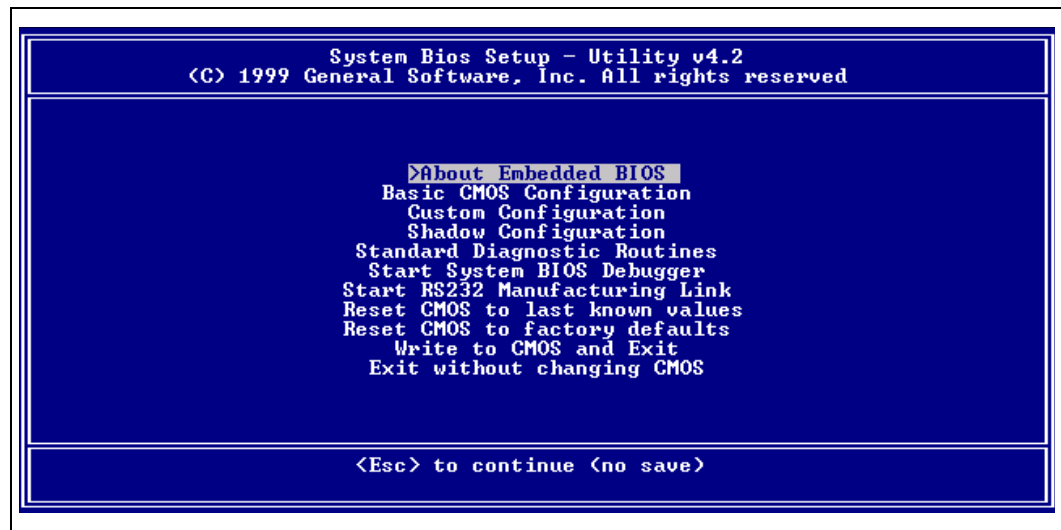

Once in the Setup Screen System (Figure 5-2), the user can navigate with the UP and DOWN arrow keys from the main console, or use the ^E and ^X keys from the remote terminal program to accomplish the same thing. TAB and ENTER are used to advance to the next field, and '+' and '-' keys cycle through values, such as those in the Basic Setup Screen, or the Diagnostics Setup Screen.

### 5.3.1 Basic CMOS Configuration Screen

The system's drive types, boot activities, and POST optimizations are configured from the Basic Setup Screen (Figure 5-3). In order to use disk drives with your system, you must select appropriate assignments of drive types in the left-hand column. Then, if you are using true floppy and IDE drives (not memory disks that emulate these drives), you need to configure the drive types themselves in the Floppy Drive Types and IDE Drive Geometry sections. Finally, you'll need to configure the boot sequence in the middle of the screen. Once these selections have been made, your system is ready to use.

Figure 5-3. Embedded BIOS Basic Setup Screen

System Bios Setup - Basic CMOS Configuration (C) 1999 General Software, Inc. All rights reserved			
<b>DRIVE ASSIGNMENT ORDER:</b>		Date: Feb 17, 2000	Typematic Delay : 250 ms
Drive A: Floppy 0		Time: 15 : 19 : 42	Typematic Rate : 30 cps
Drive B: <None>		NumLock: Disabled	Seek at Boot : Floppy
Drive C: Ide 0			Show "Hit Del" : Enabled
Drive D: <None>		<b>BOOT ORDER:</b>	Config Box : Enabled
Drive E: <None>		Boot 1st: Drive A:	F1 Error Wait : Enabled
Drive F: <None>		Boot 2nd: Drive C:	Parity Checking : <Unused>
Drive G: <None>		Boot 3rd: <None>	Memory Test Tick : Enabled
Drive H: <None>		Boot 4th: <None>	Test Above 1 MB : Enabled
Drive I: <None>		Boot 5th: <None>	Long Memory Test : <Unused>
Drive J: <None>		Boot 6th: <None>	Hexadecimal Case : Upper
Drive K: <None>			
Boot Method: Windows CE		<b>IDE DRIVE GEOMETRY:</b> Sect Hds Cyls	Memory Base:
<b>FLOPPY DRIVE TYPES:</b>		Ide 0: 3 = AUTOCONFIG. LBA	640KB
Floppy 0: 1.44 MB, 3.5"		Ide 1: Not installed	Ext:
Floppy 1: Not installed		Ide 2: Not installed	31MB
		Ide 3: Not installed	
↑/↓/←/→/⟨CR⟩/⟨Tab⟩ to select or ⟨PgUp⟩/⟨PgDn⟩/+/− to modify ⟨Esc⟩ to return to main menu			

## 5.3.2 Configuring Drive Assignments

Embedded BIOS allows the user to map a different file system to each drive letter. The BIOS allows file systems for each floppy (Floppy0 and Floppy1), each IDE drive (Ide0, Ide1, Ide2, and Ide3), and memory disks when configured (Flash0, ROM0, RAM0, etc.) Figure 5-3 shows how the first floppy drive (Floppy0) is assigned to drive A: in the system, and then how the first IDE drive (Ide0) is assigned to drive C: in the system.

To switch two floppy disks around or two hard disks around, just map Floppy0 to B: and Floppy1 to A:, and for hard disks map Ide0 to D: and Ide1 to C:.

**Caution:** Take care to not skip drive A: when making floppy disk assignments, as well as drive C: when making hard disk assignments. The first floppy should be A:, and the first hard drive should be C:. Also, do not assign the same file system to more than one drive letter. Thus, Floppy0 should not be used for both A: and B:. The BIOS permits this to allow embedded devices to alias drives, but desktop operating systems may not be able to maintain cache coherency with such a mapping in place.

A special field in this section entitled “Boot Method: (Windows CE/Boot Sector)” is used to configure the CE Ready feature of the BIOS. For normal booting (DOS, Windows NT, etc.), select “Boot Sector” or “Unused”.

### 5.3.2.1 Configuring Floppy Drive Types

If true floppy drive file systems (and not their emulators, such as ROM, RAM, or flash disks) are mapped to drive letters, then the floppy drives themselves must be configured in this section. Floppy0 refers to the first floppy disk drive on the drive ribbon cable (normally drive A:), and Floppy1 refers to the second drive (drive B:).

### 5.3.3 Configuring IDE Drive Types

If true IDE disk file systems (and not their emulators, such as ROM, RAM, or flash disks) are mapped to drive letters, then the IDE drives themselves must be configured in this section. The following table shows the drive assignments for Ide0-Ide3:

**Table 5-1. IDE0-IDE3 Drive Assignments**

File System Name	Controller	Master/Slave
Ide0	Primary (1f0h)	Master
Ide1	Primary (1f0h)	Slave
Ide2	Secondary (170h)	Master
Ide3	Secondary (170h)	Slave

To use the primary master IDE drive in your system (the typical case), just configure Ide0 in this section, and map Ide0 to drive C: in the Configuring Drive Assignments section.

The IDE Drive Types section lets you select the type for each of the four IDE drives: None, User, Physical, LBA, or CHS.

<b>User</b>	This type allows the user to select the maximum cylinders, heads, and sectors per track associated with the IDE drive. This method is now rarely used since LBA is now in common use.
<b>Physical</b>	This type instructs the BIOS to query the drive's geometry from the controller on each POST. No translation on the drive's geometry is performed, so this type is limited to drives of 512 Mbytes or less. Commonly, this is used with embedded ATA PC Cards.
<b>LBA</b>	This type instructs the BIOS to query the drive's geometry from the controller on each POST, but then translate the geometry according to the industry-standard LBA convention. This supports up to 16-Gbyte drives. <i>Use this method for all new drives.</i>
<b>CHS</b>	This type instructs the BIOS to query the drive's geometry from the controller on each POST, but then translate the geometry according to the Phoenix CHS convention. Using this type on a drive previously formatted with LBA or Physical geometry might show data as being missing or corrupted.

## 5.4 Configuring Boot Actions

Embedded BIOS supports up to six different user-defined steps in the boot sequence. When the entire system has been initialized, POST executes these steps in order until an operating system successfully loads. In addition, other pre-boot features can be run before, after, or between operating system load attempts. The following actions can be used:

<b>Drive A: - K:</b>	Boot operating system from specified drive. If “Loader” is set to “BootRecord” or “Unused”, then the standard boot record will be invoked, causing DOS, Windows95/98, Windows NT, or other industry-standard operating systems to load. If “Boot Method” is set to “Windows CE”, then the boot drive’s boot record will not be used, and instead the BIOS will attempt to load and execute the Windows CE Kernel file, NK.BIN, from the root directory of each boot device.
<b>Debugger</b>	Launch the Integrated BIOS Debugger. To return to the boot process from the debugger environment, type “G” at the debugger prompt and press ENTER.
<b>MFGMODE</b>	Initiate Manufacturing Mode, allowing the system to be configured remotely via an RS232 connect to a host computer.
<b>WindowsCE</b>	Execute a ROM-resident copy of Windows CE, if available. This feature is not applicable unless properly configured by the OEM in the BIOS adaptation.
<b>DOS in ROM</b>	Execute a ROM-resident copy of DOS, if available. This feature is not applicable unless an XIP copy of DOS, such as Embedded DOS-ROM, has been stored in the BIOS boot ROM. Copies of Embedded DOS-ROM may be obtained from General Software.
<b>None</b>	No action; POST proceeds to the next activity in the sequence.

## 5.5 Custom Configuration Setup Screen

The system’s hardware-specific features are configured with the Custom Setup Screen (Figure 5-4). All features are straightforward except for the Redirect Debugger I/O option, which is an extra embedded feature that allows the user to select whether the Integrated BIOS Debugger should use standard keyboard and video or RS232 console redirection for interaction with the user. If no video is available, the debugger is always redirected.

Figure 5-4. Embedded BIOS Custom Setup Screen

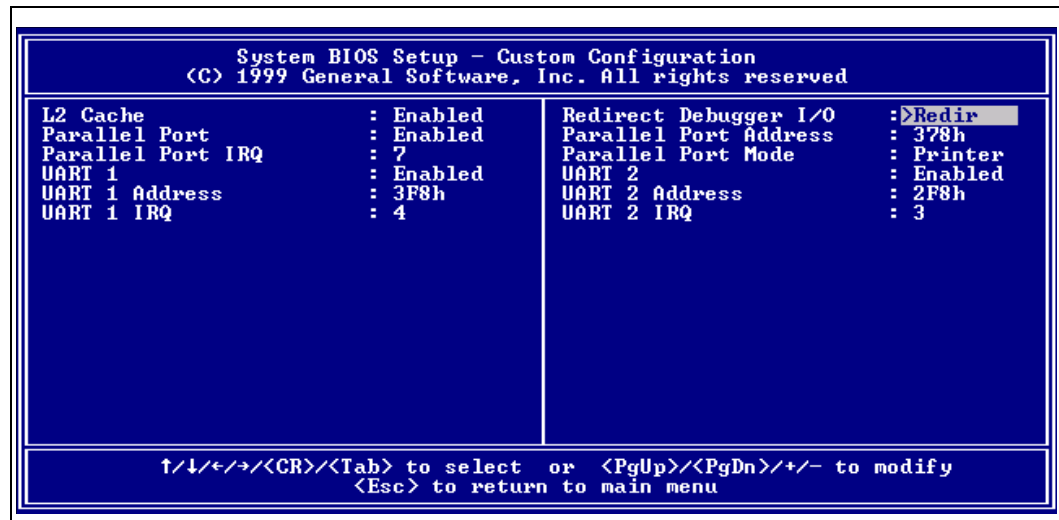

## 5.6 Shadow Configuration Setup Screen

The system's Shadow Configuration Setup Screen (Figure 5-5) allows the selective enabling and disabling of shadowing in 16 Kbyte sections, except for the top 64 Kbytes of the BIOS ROM, which is shadowed as a unit. Normally, shadowing should be enabled at C000/C400 (to enhance VGA ROM BIOS performance), and then E000-F000 should be shadowed to maximize system ROM BIOS performance.

Figure 5-5. Embedded BIOS Shadow Setup Screen

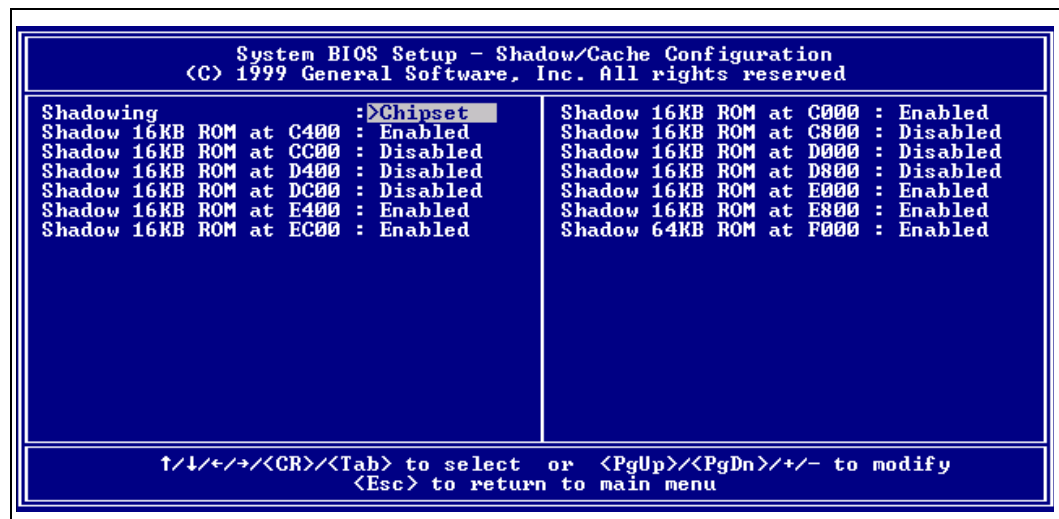

## 5.7 Standard Diagnostics Routines Setup Screen

Embedded systems may require automated burn-in testing in the development cycle. This facility is provided directly in the system’s system BIOS through the Standard Diagnostics Routines Setup Screen (Figure 5-6). To use the system, selectively enable or disable features to be tested, and then enable the “Tests Begin on ESC?” option to cause the system test suite to be invoked. To repeat the system test battery continuously, you should also enable the “Continuous Testing” option. When continuous testing is started, the system will continue until an error is encountered.

**Caution:** The disk I/O diagnostics perform write operations on those drives; therefore, only spare drives should be used which do not contain data that could be harmed by the test.

**Caution:** The keyboard test may fail when in fact the hardware is operating within reasonable limits. This is because although the device may produce occasional errors, the BIOS retries operations when failures occur during normal operation of the system.

Figure 5-6. Standard Diagnostic Routines Setup Screen

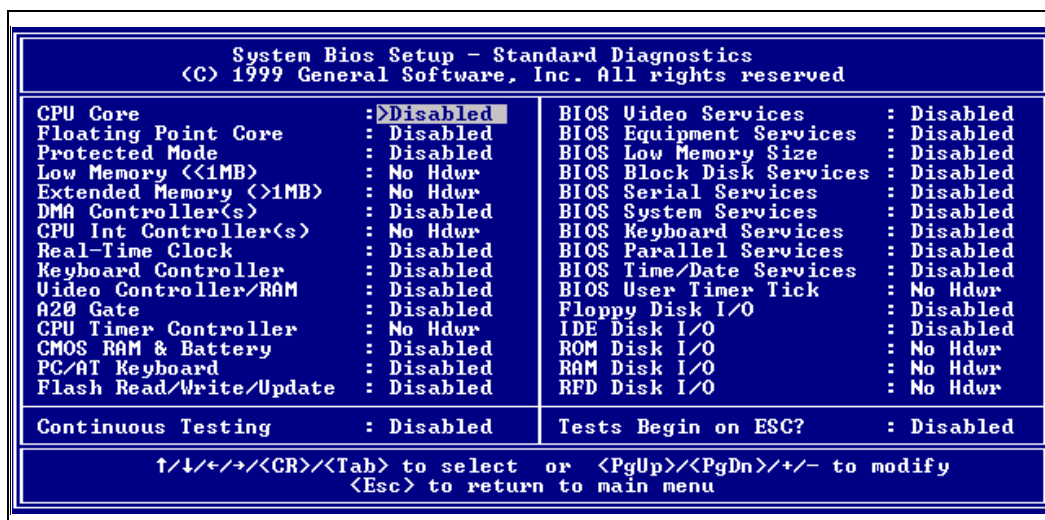

## 5.8 Start System BIOS Debugger Setup Screen

The Embedded BIOS Integrated Debugger may be invoked from the Setup Screen main menu, as well as a boot activity. Once invoked, the debugger will display the debugger prompt:

EB42DBG:

and await debugger commands. To resume back to the Setup Screen main menu, type the following command, which instructs the debugger to “go”:

EB42DBG: G<ENTER>



## 5.9 Start RS232 Manufacturing Link Setup Screen

The Embedded BIOS Manufacturing Mode may be invoked from the Setup Screen main menu, as well as a boot activity. Once invoked, Manufacturing Mode takes over the system and freezes the console of the system (Figure 5-7). The host can resume operation of the system and give control back to the system Setup Screen system with special control software.

Figure 5-7. Start RS232 Manufacturing Link Setup Screen

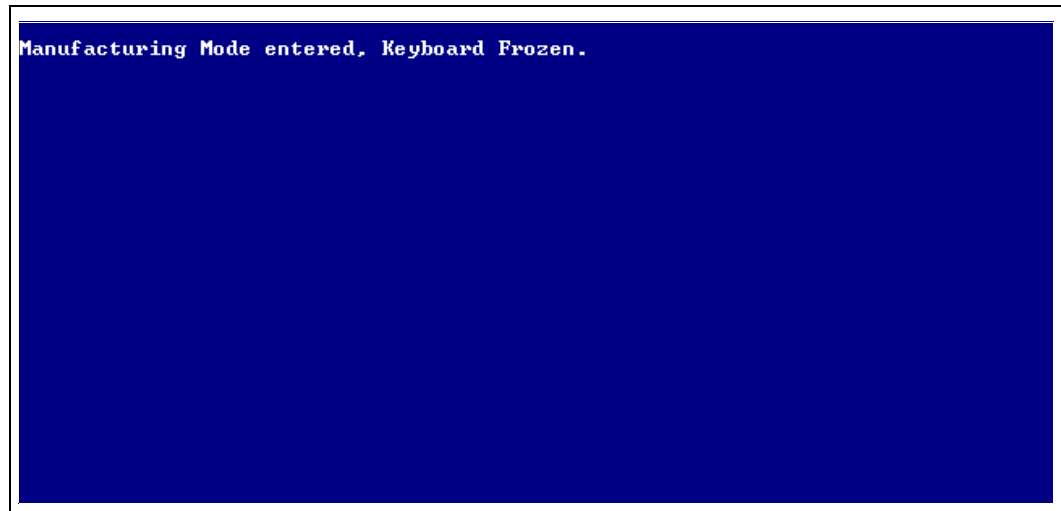

## 5.10 Manufacturing Mode

The system's BIOS provides a special mode, called Manufacturing Mode, that allows the target to be controlled by a host computer such as a laptop or desktop PC. Running special software supplied by General Software, the host can access the target's drives and manage the file systems on the target, reprogram flash memories, and test target hardware.

A full discussion of the uses of Manufacturing Mode is beyond the scope of this chapter. Complete documentation and host-side software is available directly from General Software. For more information, visit the General Software web site at <http://www.gensw.com>.

### 5.10.1 Console Redirection

The system can operate either with a standard PC/AT or PS/2 keyboard and VGA video monitor, or with a special emulation of a console over an RS232 cable connected to a host computer running a terminal program. To see an example session with HYPERTERMINAL, see the debugger section's screen display (Figure 5-9).

To use the Console Redirection feature, simply remove the video display card from the system so that no video ROM is available for the BIOS to detect. In the absence of any video support, the BIOS automatically switches its keyboard and screen functions to serial I/O over COM1 on the board. The hardware connection to the host computer requires a null modem cable.

The software on the target can be any terminal emulation program that supports ANSI terminal mode, using 9600 baud, no parity, and one stop bit (Note: This can be modified by the OEM during BIOS adaptation.) The program must be set to not use flow control, or the console may seem to stall or not accept input.

**Caution:** HYPERTERMINAL's default setting is to use flow control, which will render the console inoperative. To change this, create a new session, change the flow control setting to "none", save the session, and exit HYPERTERMINAL. Then reinvok HYPERTERMINAL with the session and it will operate with the new flow control setting.

### 5.10.2 CE-Ready Windows CE Loader

Your system's BIOS is "CE-Ready" and can directly boot Windows CE\* without loading an intermediate operating system such as DOS and LOADCEPC. Instead, the NK.BIN file can be placed on a disk drive or drive emulator, and then the BIOS can be configured through the Basic CMOS Configuration Setup Screen to boot the NK.BIN file from the boot drives instead of the boot records on those drives.

To configure your system to boot Windows CE natively from a disk drive, set the "Boot Method" field to "Windows CE" in the Basic CMOS Configuration Setup Screen. Then, place a copy of NK.BIN suitable for execution by LOADCEPC in the root directory of your normal boot drive, such as drive C:. Then, reboot the system. The configuration box should be displayed (Figure 5-8), and immediately following should be the message "Loading Windows CE..." followed by a series of dots, indicating that the loading process is continuing. Once fully loaded, Windows CE takes over the system and runs using the standard PC keyboard, screen, and PS/2 mouse.

Figure 5-8. CE-Ready Boot Feature

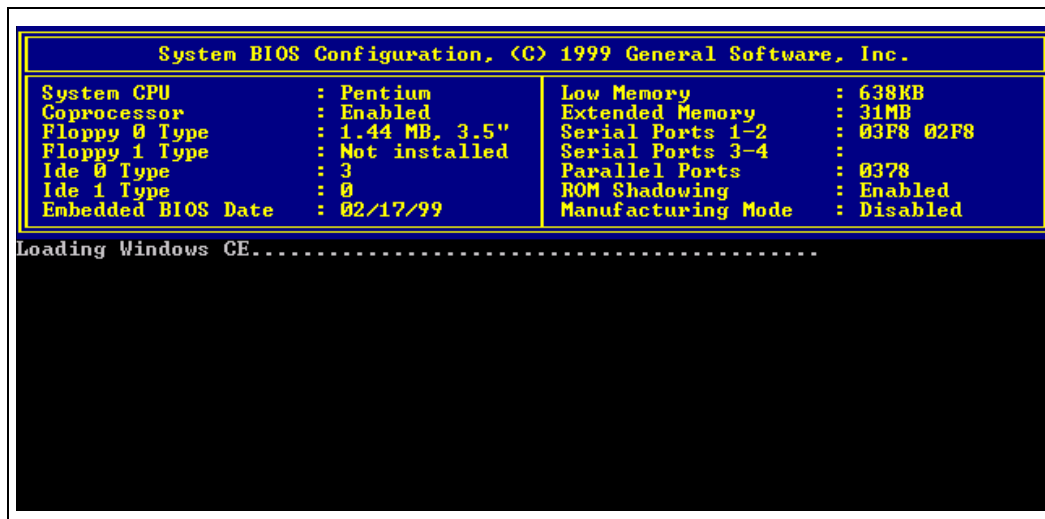

### 5.10.3 Integrated BIOS Debugger

The system's BIOS contains a built-in debugger that can be a valuable tool to aid the board bring-up process on new designs similar to the evaluation board. It supports a DOS SYMDEB-style command line interface, and can be used on the main console's keyboard and screen, or over a redirected connection to a terminal program (see "Console Redirection" on page 5-9).

To activate the debugger at any time from the main console, press the left shift and the control keys together. A display similar to the one in the HYPERTERMINAL session below (Figure 5-9) will appear, containing the title, “Embedded BIOS Debugger Breakpoint Trap” and a snapshot of the processor general registers.

Figure 5-9. Integrated BIOS Debugger Running Over a Remote Terminal

```

directcom2 - HyperTerminal
File Edit View Call Transfer Help

+-----+
|                System BIOS Configuration, (C) 1999 General Software, Inc.                |
+-----+
| System CPU      : Pentium          | Low Memory      : 638KB     |
| Coprocessor    : Enabled          | Extended Memory : 31MB     |
| Floppy 0 Type  : 1.44 MB, 3.5"    | Serial Ports 1-2 : 03F8 02F8 |
| Floppy 1 Type  : Not installed    | Serial Ports 3-4 :          |
| Ide 0 Type     : 3                | Parallel Ports  : 0378   |
| Ide 1 Type     : 0                | ROM Shadowing   : Enabled  |
| Embedded BIOS Date : 02/16/99    | Manufacturing Mode : Disabled |
+-----+
Starting MS-DOS...

A:\>echo MS-DOS 6.22 Boot and Utils Disk
MS-DOS 6.22 Boot and Utils Disk

A:\>prompt $v $p$g

MS-DOS Version 6.22 A:\>
MS-DOS Version 6.22 A:\>
MS-DOS Version 6.22 A:\>
Embedded BIOS Debugger Breakpoint Trap
EAX = 00000DEA  CS:EIP = 0DC3:00000190  EFL = 00000046  pl ZR .. na .. PE .. nc
EBX = 756E037C  SS:ESP = 0DEA:000004C6  EBP = 00000038  .. nt IOPL0 nv up di ..
ECX = 6C650001  DS:ESI = 0070:000000EE  FS = 3CF4      .. .. id vp vi al vm rf
EDX = 49654153  ES:EDI = 0DEA:000003BC  GS = 0000
0DC3:00000190  mov     bp, sp

EB42DEC:  _

Connected 1:13:13  ANSI  9600 8-N-1  SCROLL  CAPS  NUM  Capture  Print echo
    
```

To leave the debugger and resume the interrupted activity (whether POST, BIOS, DOS, Windows, or an application program), enter the “G” command (short for “go”) and press ENTER. If you were at a DOS prompt when you entered the debugger, then DOS will still be waiting for its command, and will not prompt again until you press ENTER again.

The debugger can also be entered from the Setup Screen System, and as a boot activity (see “Basic CMOS Configuration Screen” on page 5-3), as a last ditch effort during board bring-up and development if no bootable device is available.

If your version of DOS, an application, or any OEM-supplied BIOS extensions have debugging code (i.e., “INT 3” instructions) remaining, then these will invoke the debugger automatically, although this is not an error. To continue, use the “G” command. When Embedded BIOS is adapted by the OEM, the debugger can be removed from the final production BIOS, and superfluous debugging code in the application will not cause the debugger to be invoked.

A complete discussion of the debugger is beyond the scope of this chapter; however, complete documentation is available from General Software via the web at <http://www.gensw.com>.

## 5.11 Embedded BIOS POST Codes

Embedded BIOS writes progress codes, also known as POST codes, to I/O port 80H during POST, in order to provide information to OEM developers about system faults. These POST codes may be monitored on the on-board Post Code Debugger located at U12 and U13. They are not displayed on the screen. For more information about POST codes, contact General Software.

Mnemonic Code	Code	System Progress Report
POST_STATUS_START	00h	Start POST (BIOS is executing).
POST_STATUS_CPUATEST	01h	Start CPU register test.
POST_STATUS_DELAY	02h	Start power-on delay.
POST_STATUS_DELAYDONE	03h	Power-on delay finished.
POST_STATUS_KBDBATRDY	04h	Keyboard BAT finished.
POST_STATUS_DISABSHADOW	05h	Disable shadowing & cache.
POST_STATUS_CALCCKSUM	06h	Compute ROM CRC, wait for KBC.
POST_STATUS_CKSUMGOOD	07h	CRC okay, KBC ready.
POST_STATUS_BATVRFY	08h	Verifying BAT command to KB.
POST_STATUS_KBDCMD	09h	Start KBC command.
POST_STATUS_KBDDATA	0ah	Start KBC data.
POST_STATUS_BLKUNBLK	0bh	Start pin 23,24 blocking & unblocking.
POST_STATUS_KBDNOP	0ch	Start KBC NOP command.
POST_STATUS_SHUTTEST	0dh	Test CMOS RAM shutdown register.
POST_STATUS_CMOSDIAG	0eh	Check CMOS checksum.
POST_STATUS_CMOSINIT	0fh	Initialize CMOS contents.
POST_STATUS_CMOSSTATUS	10h	Initialize CMOS status for date/time.
POST_STATUS_DISABDMAINT	11h	Disable DMA, PICs.
POST_STATUS_DISABPORTB	12h	Disable Port B, video display.
POST_STATUS_BOARD	13h	Initialize board, start memory bank detection.
POST_STATUS_TESTTIMER	14h	Start timer tests.
POST_STATUS_TESTTIMER2	15h	Test 8254 T2, for speaker, port B.
POST_STATUS_TESTTIMER1	16h	Test 8254 T1, for refresh.
POST_STATUS_TESTTIMER0	17h	Test 8254 T0, for 18.2Hz.
POST_STATUS_MEMREFRESH	18h	Start memory refresh.
POST_STATUS_TESTREFRESH	19h	Test memory refresh.
POST_STATUS_TEST15US	1ah	Test 15usec refresh ON/OFF time.
POST_STATUS_TEST64KB	1bh	Test base 64KB memory.
POST_STATUS_TESTDATA	1ch	Test data lines.
POST_STATUS_TESTADDR	20h	Test address lines.
POST_STATUS_TESTPARITY	21h	Test parity (togglng).
POST_STATUS_TESTMEMRDWR	22h	Test Base 64KB memory.
POST_STATUS_SYSINIT	23h	Prepare system for IVT initialization.
POST_STATUS_INITVECTORS	24h	Initialize vector table.
POST_STATUS_8042TURBO	25h	Read 8042 for turbo switch setting.
POST_STATUS_POSTTURBO	26h	Initialize turbo data.
POST_STATUS_POSTVECTORS	27h	Modification of IVT.
POST_STATUS_MONOMODE	28h	Video in monochrome mode verified.
POST_STATUS_COLORMODE	29h	Video in color mode verified.
POST_STATUS_TOGGLEPARITY	2ah	Toggle parity before video ROM test.
POST_STATUS_INITBEFOREVIDEO	2bh	Initialize before video ROM check.

POST_STATUS_VIDEOROM	2ch	Passing control to video ROM.
POST_STATUS_POSTVIDEO	2dh	Control returned from video ROM.
POST_STATUS_CHECKEGAVGA	2eh	Check for EGA/VGA adapter.
POST_STATUS_TESTVIDEOMEMORY	2fh	No EGA/VGA found, test video memory.
POST_STATUS_RETRACE	30h	Scan for video retrace signal.
POST_STATUS_ALTDISPLAY	31h	Primary retrace failed.
POST_STATUS_ALTRETRACE	32h	Alternate found.
POST_STATUS_VRFYSWADAPTER	33h	Verify video switches.
POST_STATUS_SETDISPMODE	34h	Establish display mode.
POST_STATUS_CHECKSEG40A	35h	Initialize ROM BIOS data area.
POST_STATUS_SETCURSOR	36h	Set cursor for power-on msg.
POST_STATUS_PWRONDISPLAY	37h	Display power-on message.
POST_STATUS_SAVECURSOR	38h	Save cursor position.
POST_STATUS_BIOSIDENT	39h	Display BIOS identification string.
POST_STATUS_HITDEL	3ah	Display "Hit <DEL> to ..." message.
POST_STATUS_VIRTUAL	40h	Prepare protected mode test.
POST_STATUS_DESCR	41h	Prepare descriptor tables.
POST_STATUS_ENTERVM	42h	Enter virtual mode for memory test.
POST_STATUS_ENABINT	43h	Enable interrupts for diagnostics mode.
POST_STATUS_CHECKWRAP1	44h	Initialize data for memory wrap test.
POST_STATUS_CHECKWRAP2	45h	Test for wrap, find total memory size.
POST_STATUS_HIGHPATTERNS	46h	Write extended memory test patterns.
POST_STATUS_LOWPATTERNS	47h	Write conventional memory test patterns.
POST_STATUS_FINDLOWMEM	48h	Find low memory size from patterns.
POST_STATUS_FINDHIMEM	49h	Find high memory size from patterns.
POST_STATUS_CHECKSEG40B	4ah	Verify ROM BIOS data area again.
POST_STATUS_CHECKDEL	4bh	Check for <DEL> pressed.
POST_STATUS_CLREXTMEM	4ch	Clear extended memory for soft reset.
POST_STATUS_SAVEMEMSIZE	4dh	Save memory size.
POST_STATUS_COLD64TEST	4eh	Cold boot: Display 1st 64KB memtest.
POST_STATUS_COLDLOWTEST	4fh	Cold boot: Test all of low memory.
POST_STATUS_ADJUSTLOW	50h	Adjust memory size for EBDA usage.
POST_STATUS_COLDHITEST	51h	Cold boot: Test high memory.
POST_STATUS_REALMODETEST	52h	Prepare for shutdown to real mode.
POST_STATUS_ENTERREAL	53h	Return to real mode.
POST_STATUS_SHUTDOWN	54h	Shutdown successful.
POST_STATUS_DISABA20	55h	Disable A20 line.
POST_STATUS_CHECKSEG40C	56h	Check ROM BIOS data area again.
POST_STATUS_CHECKSEG40D	57h	Check ROM BIOS data area again.
POST_STATUS CLRHITDEL	58h	Clear "Hit <DEL>" message.
POST_STATUS_TESTDMAPAGE	59h	Test DMA page register file.
POST_STATUS_VRFYDISPMEM	60h	Verify from display memory.
POST_STATUS_TESTDMA0BASE	61h	Test DMA0 base register.
POST_STATUS_TESTDMA1BASE	62h	Test DMA1 base register.
POST_STATUS_CHECKSEG40E	63h	Checking ROM BIOS data area again.
POST_STATUS_CHECKSEG40F	64h	Checking ROM BIOS data area again.
POST_STATUS_PROGDMA	65h	Program DMA controllers.
POST_STATUS_INITINTCTRL	66h	Initialize PICs.
POST_STATUS_STARTKBDTEST	67h	Start keyboard test.
POST_STATUS_KBDRESET	80h	Issue KB reset command.
POST_STATUS_CHECKSTUCKKEYS	81h	Check for stuck keys.
POST_STATUS_INITCIRCBUFFER	82h	Initialize circular buffer.
POST_STATUS_CHECKLOCKEDKEYS	83h	Check for locked keys.
POST_STATUS_MEMSIZEMISMATCH	84h	Check for memory size mismatch.
POST_STATUS_PASSWORD	85h	Check for password or bypass setup.

POST_STATUS_BEFORESETUP	86h	Password accepted.
POST_STATUS_CALLSETUP	87h	Entering setup system.
POST_STATUS_POSTSETUP	88h	Setup system exited.
POST_STATUS_DISPPWRON	89h	Display power-on screen message.
POST_STATUS_DISPWAIT	8ah	Display "Wait..." message.
POST_STATUS_ENABSHADOW	8bh	Shadow system & video BIOS.
POST_STATUS_STDCMOSSETUP	8ch	Load standard setup values from CMOS.
POST_STATUS_MOUSE	8dh	Test and initialize mouse.
POST_STATUS_FLOPPY	8eh	Test floppy disks.
POST_STATUS_CONFIGFLOPPY	8fh	Configure floppy drives.
POST_STATUS_IDE	90h	Test hard disks.
POST_STATUS_CONFIGIDE	91h	Configure IDE drives.
POST_STATUS_CHECKSEG40G	92h	Checking ROM BIOS data area.
POST_STATUS_CHECKSEG40H	93h	Checking ROM BIOS data area.
POST_STATUS_SETMEMSIZE	94h	Set base & extended memory sizes.
POST_STATUS_SIZEADJUST	95h	Adjust low memory size for EBDA.
POST_STATUS_INITC8000	96h	Initialize before calling C800h ROM.
POST_STATUS_CALLC8000	97h	Call ROM BIOS extension at C800h.
POST_STATUS_POSTC8000	98h	ROM C800h extension returned.
POST_STATUS_TIMERPRNBASE	99h	Configure timer/printer data.
POST_STATUS_SERIALBASE	9ah	Configure serial port base addresses.
POST_STATUS_INITBEFORENPX	9bh	Prepare to initialize coprocessor.
POST_STATUS_INITNPX	9ch	Initialize numeric coprocessor.
POST_STATUS_POSTNPX	9dh	Numeric coprocessor initialized.
POST_STATUS_CHECKLOCKS	9eh	Check KB settings.
POST_STATUS_ISSUEKBDID	9fh	Issue keyboard ID command.
POST_STATUS_RESETID	0a0h	KB ID flag reset.
POST_STATUS_TESTCACHE	0a1h	Test cache memory.
POST_STATUS_DISPSTERR	0a2h	Display soft errors.
POST_STATUS_TYPERMATIC	0a3h	Set keyboard typematic rate.
POST_STATUS_MEMWAIT	0a4h	Program memory wait states.
POST_STATUS_CLRSCR	0a5h	Clear screen.
POST_STATUS_ENABPTYNMI	0a6h	Enable parity and NMIs.
POST_STATUS_INITE000	0a7h	Initialize before calling ROM at E000h.
POST_STATUS_CALLE000	0a8h	Call ROM BIOS extension at E000h.
POST_STATUS_POSTE000	0a9h	ROM extension returned.
POST_STATUS_DISPCONFIG	0b0h	Display system configuration box.
POST_STATUS_INT19BOOT	00h	Call INT 19h bootstrap loader.
POST_STATUS_LOWMEMEXH	0b1h	Test low memory exhaustively.
POST_STATUS_EXTMEMEXH	0b2h	Test extended memory exhaustively.
POST_STATUS_PCIEENUM	0b3h	Enumerate PCI busses.

## 5.12 Embedded BIOS Beep Codes

Embedded BIOS tests much of the system hardware early in POST before messages can be displayed on the screen. When system failures are encountered at these early stages, POST uses beep codes (a sequence of tones on the speaker) to identify the source of the error.

The following is a comprehensive list of POST beep codes for the system BIOS. BIOS extensions, such as VGA ROMs and SCSI adapter ROMs, may use their own beep codes, including short/long sequences, or possibly beep codes that sound like the ones below. When diagnosing a system failure, remove these adapters if possible before making a final determination of the actual POST test that failed.

Mnemonic Code	Beep Count	Description of Problem
POST_BEEP_REFRESH	1	Memory refresh is not working.
POST_BEEP_PARITY	2	Parity error found in 1st 64KB of memory.
POST_BEEP_BASE64KB	3	Memory test of 1st 64KB failed.
POST_BEEP_TIMER	4	T1 timer test failed.
POST_BEEP_CPU	5	CPU test failed.
POST_BEEP_GATEA20	6	Gate A20 test failed.
POST_BEEP_DMA	7	DMA page/base register test failed.
POST_BEEP_VIDEO	8	Video controller test failed.
POST_BEEP_KEYBOARD	9	Keyboard test failed.
POST_BEEP_SHUTDOWN	10	CMOS shutdown register test failed.
POST_BEEP_CACHE	11	External cache test failed.
POST_BEEP_BOARD	12	General board initialization failed.
POST_BEEP_LOWMEM	13	Exhaustive low memory test failed.
POST_BEEP_EXTMEM	14	Exhaustive extended memory test failed.
POST_BEEP_CMOS	15	CMOS restart byte test failed.
POST_BEEP_ADDRESS_LINE	16	Address line test failed.
POST_BEEP_DATA_LINE	17	Data line test failed.
POST_BEEP_INTERRUPT	18	Interrupt controller test failed.
POST_BEEP_PASSWORD	1	Incorrect password used to access SETUP.







# PLD Code Listing

# A

The code listing below is for the 22V10 PLD.

```
TITLE      22V10 PORT 80 ADDRESS DECODER / FLASH DECODE
PATTERN    1
REVISION   B
AUTHOR     CHRIS BANYAI
COMPANY    INTEL CORPORATION
DATE       10/1/97

OPTIONS
    SECURITY = OFF

; ( part was 22V10FN before conversion )
CHIP P80B iPLD22V10N

PIN        19      IOWR_BAR
PIN        3       AEN
PIN        [6:7]   SA[0:1]
PIN        [9:13]  SA[2:6]
PIN        16      SA7
PIN        [5:4]   SA[8:9]
PIN        [26:23] SA[19:16]
PIN        [21:20] SA[15:14]
PIN        2       SEL

PIN        18      /CS_BAR
PIN        17      /CS_DOC
PIN        27      OX

EQUATIONS
CS_BAR = /IOWR_BAR * /AEN * /SA0 * /SA1 * /SA2 * /SA3 * /SA4 * /SA5 * /SA6
        * SA7 * /SA8 * /SA9
CS_BAR.TRST = VCC

CS_DOC = /SEL * /AEN * SA19 * SA18 * /SA17 * /SA16 * SA15 * /SA14
        + SEL * /AEN * SA19 * SA18 * /SA17 * SA16 * /SA15 * /SA14
CS_DOC.TRST = VCC

OX = /IOWR_BAR
OX.TRST = VCC

SIMULATION

SETF /AEN /SA0 /SA1 /SA2 /SA3 /SA4 /SA5 /SA6 /SA7 /SA8 /SA9 IOWR_BAR
SETF SA7 IOWR_BAR
SETF /IOWR_BAR
SETF IOWR_BAR
```

```
SETF AEN /IOWR_BAR
SETF /AEN
SETF IOWR_BAR
SETF SA0 /IOWR_BAR
SETF /SA0 /IOWR_BAR
SETF IOWR_BAR
SETF /SA0 /SA1 /SA2 /SA3 /SA4 /SA5 /SA6 /SA7 /SA8 /SA9
SETF /SA19 /SA18 /SA17 /SA16 /SA15 /SA14
SETF /SEL
SETF SA19 SA18 /SA17 /SA16 SA15 /SA14
SETF /SEL
SETF /AEN
SETF /SA19
SETF SA19
SETF /SA18
SETF SA18
SETF SA17
SETF /SA17
SETF SA16
SETF /SA16
SETF /SA15
SETF SA15
SETF SA14
SETF /SA14
SETF /SEL
SETF SA19 SA18 /SA17 SA16 /SA15 /SA14
SETF /SEL
SETF /AEN
SETF SEL
SETF /SA19
SETF SA19
SETF /SA18
SETF SA18
SETF SA17
SETF /SA17
SETF /SA16
SETF SA16
SETF SA15
SETF /SA15
SETF SA14
SETF /SA14
SETF /SEL
```



# Bill of Materials

# B

Table B-1 is the bill of materials for the baseboard. Table B-2 is the bill of materials for the Processor Assembly.

**Table B-1. Baseboard Bill of Materials (Sheet 1 of 4)**

Reference	Description	Manufacturer	Manufacturer P/N	Notes
J14,J15	Conn,Jumper2,1X2 25-mil sq/ 100-mil space,HDR2	3M	929647-09-02	
J20-24	Conn,Jumper3,1X3 25-mil sq/ 100-mil space,HDR3	3M	929647-09-03	
JP2	Conn,Speaker,1X4 25-mil sq/ 100-mil space,HDR4	3M	929647-09-04	
J10	NOT POPULATED			DO NOT POPULATE
J12	Conn,Fan	AMP	173981-3	
XU9	PLCC, Socket 28	AMP	822271-1	
J19	Conn,CPU,400 Pin Array (BGA),BGA40X10-400R	Berg	74219-002	
U6	IC,Clock Generator,CK100,SSOP300- 48(PIN)	Cypress	CY2280PVC-11S	
U26	IC,Clock Buffer,Zero Delay 3.3V,16PIN,150MIL,TSSOP,PSS OP16	Cypress	CY2309ZC-1H	
U16	IC,Clock Buffer,18 Output low skew,SSOP300-48(PIN)	Cypress	CY2318ANZPVC-1	
Y2	Crystal,32.768KHz,XTAL/MC- 405	Epson	MC-405	
J17,J18	Conn,SDRAM DIMM,168 Pin Recept	FOXCONN	AT08403-K8	DO NOT POPULATE J16
J4	Conn, Serial Stack,DB9MX2	FOXCONN	DM10156-73	
J3	Conn, DB25,DB25FM1	FOXCONN	DT11323-R5T	
J7,J8,J9	Conn,PCI Edge Recept,145154- 120	FOXCONN	EH06001-PC-W	
J5,J6	Conn,ISA Edge Recept.,isa-98	FOXCONN	EQ04901-S6	
JP1	Conn,Floppy,17X2 Header	FOXCONN	HL07173-P4	
JP3,JP4	Conn, IDE,20X2 Header	FOXCONN	HL07206-D2	
J11	Conn,Power,5566DP-20/ATX	FOXCONN	HM20100-P2	
J1	Conn,PS2 Keyboard / Mouse Connector	FOXCONN	MH11067-D2	
J13	Conn,AGP Edge Recept., 120 pins,AGP-124	FOXCONN	PC1243K-10	
J2	2 USB Stack Connectors	FOXCONN	UB1112C-D3	

Table B-1. Baseboard Bill of Materials (Sheet 2 of 4)

Reference	Description	Manufacturer	Manufacturer P/N	Notes
U11	BIOS FLASH Memory,TSOP12X20/40S	INTEL	28F002BC	
U8	VLSI,PIIX4,PCI to IDE &ISA Bridge,324 mBGA,BGA20x20- 324	Intel	FW82371EB	
U14	IC,Interrupt Controller, 82093AA,QFP16x22-64	INTEL	S82093AA	DO NOT POPULATE
C99,C100,C132,C133,C2 09,C214	Chip Capacitor,10pF, 50V,CC0603	Kemet	C0603C100J5GAC	
C: 22,42-43,48-49,54,59- 65,70-71,73,75-76,85- 87,90-92,96-97, 102,106- 108,111-112,114,116-118, 126-127,129- 131,142,147,157,159-162, 174-176,181-183, 187- 200,205-206,208,226-228	Chip Capacitor,0.1uF, 16V,CC0603	Kemet	C0603C104K4RAC	DO NOT POPULATE C143, C146,C203, C210, C215
C27-C41,C44-C47,C50- C53	Chip Capacitor,470pF, 50V,CC0603	Kemet	C0603C471K5RAC	
C3-5,C8,C55-57, C94,C119-121, C134,C138,C145, C153	Cap,Tant,10uF,15V,C Case,6032	Kemet	T491C106K016AS	
C93,C103-105, C128,C152, C154-156	Cap,Tant,47uF, 20V,D Case,7343	Kemet	T491D476M020AS	
C2,C6,C58,C72, C84,C88,C89,C95, C109	Cap,Tant,100uF, 10V,D Case,7343	Kemet	T495D107M010AS	
C1,C7,C23,C66- C68,C74,C77-C82, C101,C113,C115, C141,C158,C163- 173,C177-180, C184- 186,C201- 202,C204,C207, C211- 213,C216-217,C220-C225	Chip Capacitor,0.01uF 50V,CC0603	Kemet	C0603C103J5RAC	
U9	IC,PLD,PLCC28,Socket28	LATTICE	GAL22V10B-7LJ	
U23	IC,Linear Voltage Regulator,SOT-223	Linear Tech.	LT1117-3.3cst	
U5	IC,Linear Voltage Regulator,SOT-223	Linear Tech.	LT1117CST	
XU11	40TSOP BIOS Socket,TSOP12X20/40S	Meritec	980020-40-01	
XU12,XU13	TIL311 SOCKET,DIP14	MILLMAX	110-99-314-41-001	
U25	IC,Logic,74ACT05,SO14	Motorola	MC74ACT05DR	
FB1-FB9	Ferrite Bead,SM1806,Z-Bead	Murata	BLM41A800S	
U22	IC,Logic,74ALS00,SOIC14	National	DM74ALS00M	
U7	IC,Tranceiver,8-Bit Bidirectional Buffer,SOIC20,SO20W	National	DM74ALS245AWM	
C69,C83,C98,C110	Cap,Electrolitic,220uF, 25v,6.3mmx11.2mm,PCAPR200 -300	Panasonic	ECE-A1EU221	

**Table B-1. Baseboard Bill of Materials (Sheet 3 of 4)**

Reference	Description	Manufacturer	Manufacturer P/N	Notes
R33,R35,R37,R48,R52,R98-R100, R106,R108-R116,R118-R122	Chip Resistor,0 Ohm Shunt,5%,CR0805	Panasonic	ERJ6GEY0R00V	DO NOT POPULATE R33, R35, R37
R6,R25,R42,R45,R49-R51,R63,R101,R102	Chip Resistor,1K,5%,CR0805	Panasonic	ERJ6GEYJ102V	DO NOT POPULATE R6, R51
R2,R4,R5,R11,R40,R41,R43,R53-R56,R97,R105,R117,R123-124,R127	Chip Resistor,10K,5%,CR0805	Panasonic	ERJ6GEYJ103V	
R1,R3,R88,R89.R90,R91	Chip Resistor,15K,5%,CR0805	Panasonic	ERJ6GEYJ153V	
R9	Chip Resistor,22,5%,CR0805	Panasonic	ERJ6GEYJ220V	
R10,R12,R13,R14,R39,R58,R70	Chip Resistor,220,5%,CR0805	Panasonic	ERJ6GEYJ221V	
R92-R95	Chip Resistor,27,5%,CR0805	Panasonic	ERJ6GEYJ270V	
R20,R44,R57,R71	Chip Resistor,2.7K,5%,CR0805	Panasonic	ERJ6GEYJ272V	
R17-R19,R21-R24,R26-R32,R34,R36,R38	Chip Resistor,33,5%,CR0805	Panasonic	ERJ6GEYJ330V	
R103,R104	Chip Resistor,470,5%,CR0805	Panasonic	ERJ6GEYJ471V	
R7,R64-R69, R125,R126,R128	Chip Resistor,4.7k,5%,CR0805	Panasonic	ERJ6GEYJ472V	
R72-R87,R96,R107	Chip Resistor,8.2K,5%,CR0805	Panasonic	ERJ6GEYJ822V	
S1,S2	Switch-Push Button,PBSW/PNASNC2	Panasonic	EVQ-PHP03T	
RP2,RP3,RP41-RP47,RP54-RP56, RP58,RP60,RP61	Res,Array,SMT,33,5%,EXB-V	Panasonic	EXB33V330JV	
RP10,RP18,RP23	Res,Array,SMT,1K,5%,EXB-V	Panasonic	EXB38V102JV	
RP8-9,RP11,RP13-17,RP19-RP22, RP24,RP26-33, RP35-36, RP39, RP51-52,RP59	Res,Array,SMT,10K,5%,EXB-V	Panasonic	EXB38V103JV	
RP1,RP4,RP48	Res,Array,SMT,22,5%,EXB-V	Panasonic	EXB38V220JV	
RP25,RP37,RP38,RP40,RP49,RP50,RP53	Res,Array,SMT,2.7K,5%,EXB-V	Panasonic	EXB38V272JV	
RP57	Res,Array,SMT,47,5%,EXB-V	Panasonic	EXB38V470JV	
RP5,RP6,RP7	Res,Array,SMT,4.7K,5%,EXB-V	Panasonic	EXB38V472JV	
RP12,RP34	Res,Array,SMT,5.6k,5%,EXB-V	Panasonic		
U24	IC,Logic,Inverter, Schmitt Trigger,SOIC14	Philips	74HCT14D	
U10	IC,Logic,10 Bit Bus Switch,QSOP,SO24W	Quality Semi	QS3384SO	
Y1	Crystal,14.318MHz,XTAL,FOX-HC495D	Raltron	AS-14.31818-20	
F1-F3	Fuse,Drawing,SM250	RayChem	SMD250-2	

**Table B-1. Baseboard Bill of Materials (Sheet 4 of 4)**

Reference	Description	Manufacturer	Manufacturer P/N	Notes
XBT1	Battery Holder Socket	Renata	HU-2032-1	
BT1	Battery	Renata	CR2032	
D1,D2,D5	Diode,LED,SOT23-A	Siemens	LGS260-DO	
U1	VLSI,Super I/O,QFP128	SMSC	FDC37B78X	
C122-C125,C229	Chip Capacitor,47pF,CC0603	TDK	C1608C0G1H470JT\$	DO NOT POPULATE C229
C9-C21,C24-C26	Chip Capacitor,220pF,CC0603	TDK	C1608X7R1H221KT009A	
U15	IC,Logic,3 state buffer,SOP-14	TI	74LVC125A	
U21	IC,Logic,SOP-14	TI	74LVC14A	
U3,U4	IC,RS232 Transceiver, SOIC20,SO20W	TI	GD75232DW	
U2	IC,Logic,Open Drain Buffer,SOP- 14	TI	SN7407D	
U12,U13	7 Segment LED display,DIP14	TI	TIL311	
D3-D4,D6-D7	Schottky Diode,SOT23-E	ZETEX	BAT54	
R8,R15,R16,R46,R47	Chip Resistor,124,1%,CR0805			
	32 MB SDRAM DIMMS	Micron Semiconductor Prdcts	MT4LSDT464AG-662B2	

**Table B-2. Celeron™ Processor Assembly Bill of Materials (Sheet 1 of 2)**

Reference	Descriptions				Manufacturer	Manufacturer P/N
C1	CAP	20 pF	25V	CC0603	Panasonic	ECU-V1H200JCM
C117	CAP	4700pF	50V	CC0603	Panasonic	ECJ-1VB1H472K
C84-C85, C94-C98	CAP	0.01uF	10V	CC0603	Panasonic	ECJ-1VB1C103K
C2-9, C48,C50-83,C86-93,C100-103,C106,C110,C113,C115,C116,C128-C129,C131-C132,C137-C138, C140-C142,C145-C146	CAP	0.1uF	16V	CC0603	Panasonic	ECJ-1VB1C104K
C10-C24,C30-C34,C40-C44,C112,C114,C126,C133-136	CAP	1uF	10V	CC0805	Panasonic	ECJ-2YB1A105K
C25-C29,C35-C39,C45-C47,C139	CAP	4.7uF	10V	CC1206	Panasonic	ECJ-3YF1C475Z
C122-C125	CAP	10uF	16V	CC1210	Panasonic	Do Not Populate
C49	CAP	33uF	16V	3528	Kernet	T491B226M010AS
C104-C105,C127,C130,	CAP	470uF	16V	PCAPR20 0-300	Panasonic	EEU-FC1C471L
C107-C109,C111,C118-C121	CAP	2200uF	16V	PCAPR20 0-500	Panasonic	EEU-FC1C222
D1	Diode	BAT54		SOT23	Zetex	BAT54CT-ND
L1	Inductor	22 uH		CR0805	Murata	LQG21C220N00T1
L2,L3	Inductor	4.7uH		IND1855	Bi Technologies	HM00-98637A
Q1	NPN Transistor	MMBT3904		SOT23	Fairchild	MMBT3904
RP1-RP2	Resistor Pac	1K		EXB-V	Panasonic	EXB-V8V102JV
RP33-RP62	Resistor Pac	56 ohm		EXB-V	Panasonic	EXB-V8V560JV
RP63	Resistor Pac	330		EXB-V	Panasonic	EXB-V8V331JV
R9,R12,R54,R66,R78,R79	Resistor	0		CR0805	Panasonic	ERJ-6GEY0R00V
R14	Resistor	1.1		CR0805	Panasonic	ERX-1SJ1R1
R68,R71,R72	Resistor	2.2		CR1206	Panasonic	ERJ-6RQJ2R2V
R65,R63	Resistor	10		CR0805	Panasonic	ERJ-6GEYJ100V
R19,R26-R27	Resistor	22		CR0805	Panasonic	ERJ-6GEYJ220V
R4,R41,R48,R50,R51,R77	Resistor	51		CR0805	Panasonic	ERJ-6GEYJ510V
R1,R7,R8,R31,R46,R47,R49,R52	Resistor	270		CR0805	Panasonic	ERJ-6GEYJ271V
R10	Resistor	330		CR0805	Panasonic	ERJ-6GEYJ331V
R2-R3, R15,R32-R39,R42-R43,R45,R53,R64,R67,R80	Resistor	1K		CR0805	Panasonic	ERJ-6GEYJ102V
R11,R13,R40,R44	Resistor	3.3K		CR0805	Panasonic	ERJ-6GEYJ332V
R16-R18,R20-R25,R28-R30,R70	Resistor	10K		CR0805	Panasonic	ERJ-6GEYJ102V

Table B-2. Celeron™ Processor Assembly Bill of Materials (Sheet 2 of 2)

Reference	Descriptions			Manufacturer	Manufacturer P/N	
R75,R73	Resistor	47K		CR0805	Panasonic	ERJ-6GEYJ472V
R55,R56	Resistor	75 1%		CR0805	Panasonic	ERJ-6ENF0750V
R60	Resistor	100 1%		CR0805	Panasonic	ERJ-6ENF1000V
R6,R5	Resistor	110 1%		CR0805	Panasonic	ERJ-6ENF1100V
R57-R59	Resistor	150 1%		CR0805	Panasonic	ERJ-6ENF1500V
R61	Resistor	1.00K 1%		CR0805	Panasonic	ERJ-6ENF1001V
R62	Resistor	2.32K 1%		CR0805	Panasonic	ERJ-6ENF2321V
R69,R74,R76	Resistor	3 milliOhm 5%		CR2512	Dale/Vishay	WSL-2512 0.003 5%
U2,U3	Logic	74LVC07A		SO14	Texas Instruments	SN74LVC07AD
U4	BGA Chip	443BX_10			Intel	FW82443BX
U5	BGA Connector			BGA40X1 0-400	Berg	74220-001
U6	Temp Sensor	MAX1617		QSOP16	Maxim	MAX1617MEE
U7	Logic	QS3257		SO16	Quickswitch	QS3257
U8	Logic	74LVQ00		SO14	National Semiconductor	74LVQ00
U9	Logic	SC1185		SO24W	Semtech	SC1185
U10,U11	FET	SUD50N03-07		TO252	Siliconix	SUD50N03-07-T4
U12,U13	FET	MTD3055V		TO252	Motorola	MTD3055V
U1	Processor, 370-pin, 37x37 PPGA, 366 MHz OR (depends on kit purchased) Processor, 370-pin, 37x37 PPGA, 433 MHz				Intel	FV80524RX366128 FV80524RX433128
XU1	Socket	Socket370			AMP	916783-2
	Socket	Socket370			Foxconn	PZ37047S1T-S-001
J2	Header	ITP		104068-3	AMP	104068-3
J1	Connector	Fan Connector		173981-3	AMP	173981-3
J3	Connector	4 Pin PWR		644518-4	AMP	644518-4



The most current schematics, including “flat” schematics (without the 400-pin connector), are located on Intel’s Developer Web site at: <http://www.intel.com/design/intarch/schems/>.

Schematics are provided for the following items:

**Baseboard:**

- Block Diagram
- Mini-PCI Connector (Not Populated)
- Processor Assembly Connector
- DIMM0
- DIMM1
- DIMM2 (Not Populated)
- Clocks
- ISA/PCI Pullups
- PCI Slots 0 & 1
- PCI Slot 2
- AGP Connector
- PIIX4 Part 1
- PIIX4 Part 2
- IDE Connectors
- Super I/O
- USB Connectors
- ISA Connectors
- COMx, DB25, Floppy
- BIOS/ Port 80
- ATX Power Connector
- Unused Gates

**Processor Assembly:**

- Socket 370A Host Interface
- Socket 370B Power Supply
- GTL+ Termination Resistors - Bridge System/Controller
- GTL+ Termination Resistors - Processor
- 82443BX - Bus Interface
- 82443BX - Memory Interface
- Connector Hardware
- ITP/Bus Ratio/Thermal Sensor
- Voltage Regulator

# Evaluation Platform System Electronics Board

## Revision D

THIS SCHEMATIC IS PROVIDED "AS IS" WITH NO WARRANTIES WHATSOEVER INCLUDING ANY WARRANTY OF MERCHANTABILITY, FITNESS FOR ANY PARTICULAR PURPOSE OR ANY WARRANTY OTHERWISE ARISING OUT OF PROPOSAL, SPECIFICATION OR SAMPLE.

No license, express or implied, by estoppel or otherwise, to any intellectual property rights is granted herein.

Intel disclaims all liability, including liability for infringement of any proprietary rights, relating to use of information in this specification. Intel does not warrant or represent that such use will not infringe such rights.

### History

Changes made to Revision D.

1. Added Signals PWROK(A24) +12V(A33) MB12#\_R(B33) to J19A.
2. Moved J20
3. Added C229 to -PCIRST

Changes made to Revision C.

1. Tied VBAT (pin 65) to 3.3V on Super I/O.

Changes made to Revision B.

1. Swapped AD23 and AD19 on 400 pin connector.
2. Separated CSEL on IDE0 and IDE1
3. Swapped pins 1 and 3 (V5 with TP) on CPU-Fan connector.
4. Tied VBAT (pin 65) to 5.0V on Super I/O.
5. Changed RP48 to 4.7K. (Pullups for mouse and keyboard.)
6. Inverted POWERON# signal (SUSC#) from PII4 to control software on feature.
7. Changed Bulk decoupling on +12 and -12 to 2x220uF from 2x400uF.
8. Changed Bulk decoupling cap C154 from 10uF to 47uF to reduce EMI line items.

THIS DRAWING CONTAINS INFORMATION WHICH HAS NOT BEEN VERIFIED FOR MANUFACTURING AS AN END USER PRODUCT. INTEL IS NOT RESPONSIBLE FOR THE MISUSE OF THIS INFORMATION.

File	Changes
Doc	Document Number
Rev	D
Date	Thursday, February 26, 1998

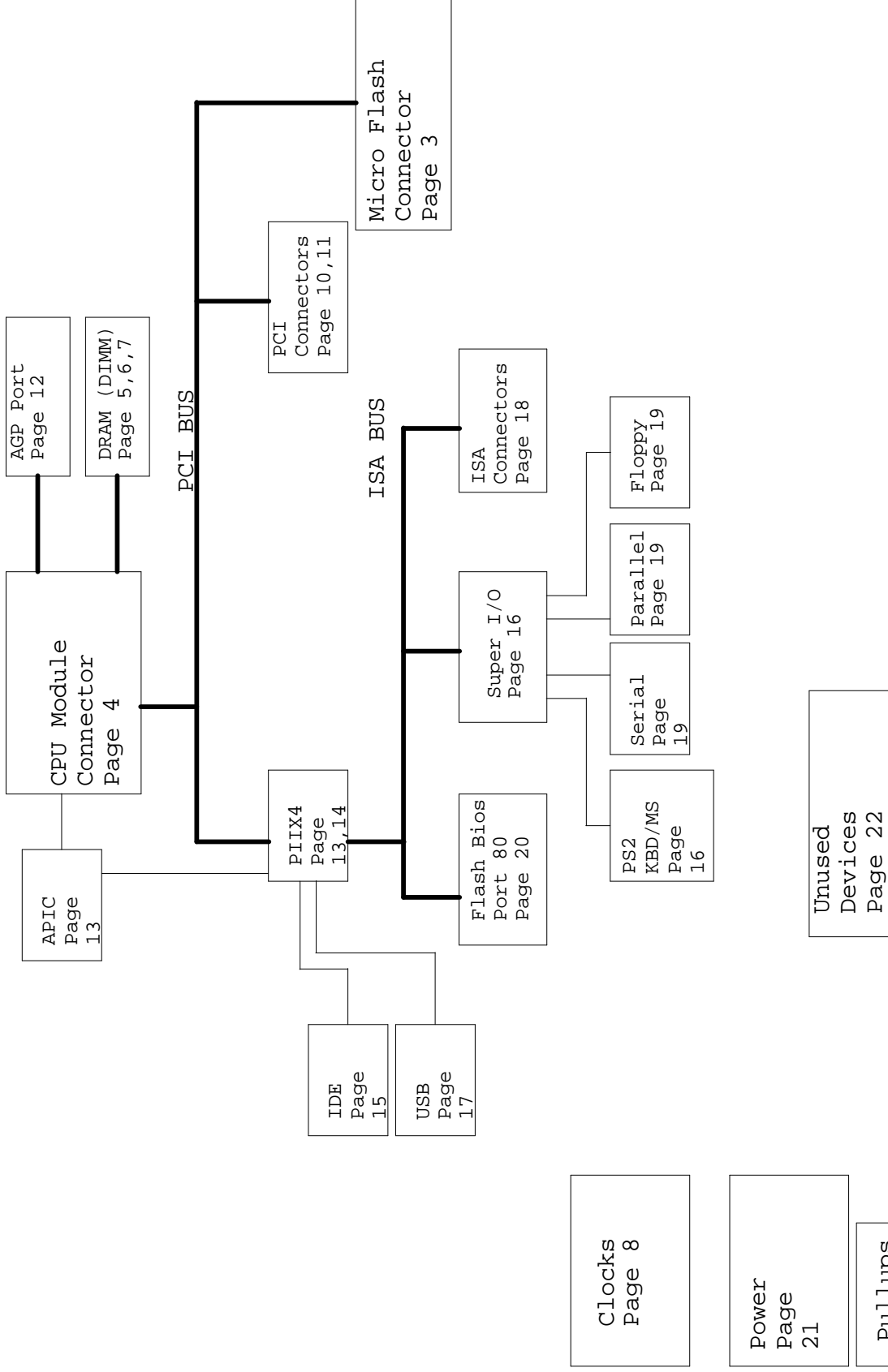

THIS DRAWING CONTAINS INFORMATION WHICH HAS NOT BEEN VERIFIED FOR MANUFACTURING AS AN END USER PRODUCT. INTEL IS NOT RESPONSIBLE FOR THE MISUSE OF THIS INFORMATION.

File	Shakopee
Doc Number	104
Rev	D
Date	Thursday, February 26, 1999
Sheet	2 of 22

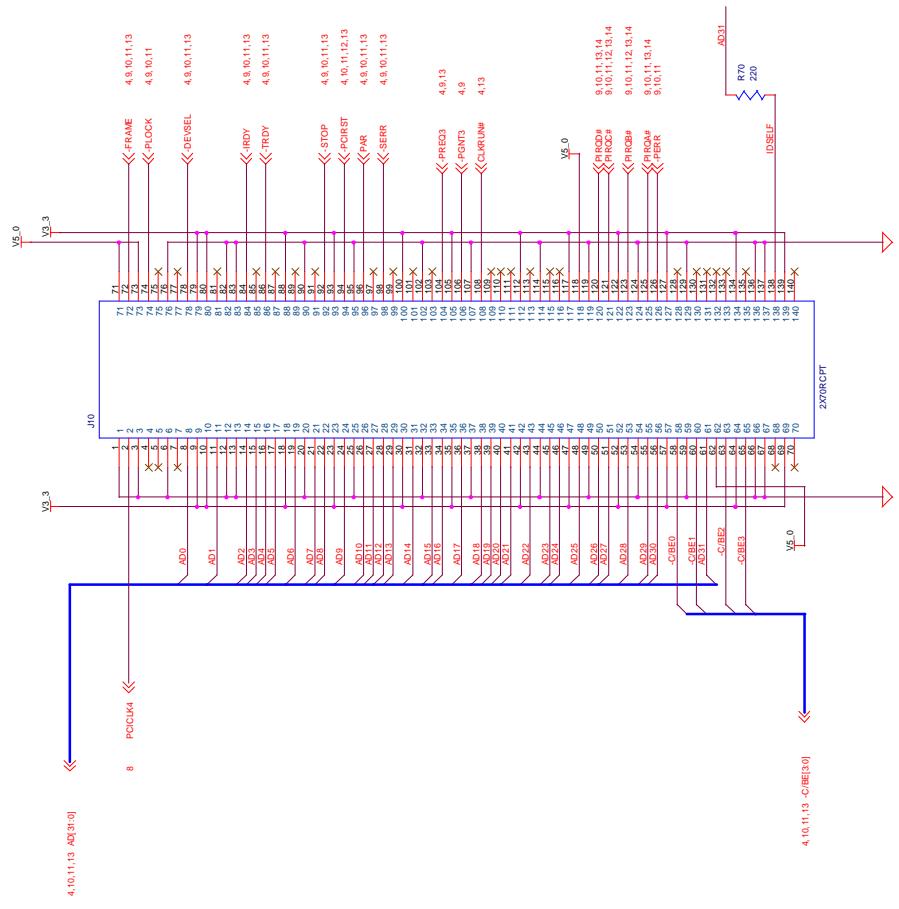

THIS DRAWING CONTAINS INFORMATION WHICH IS NOT  
 BEEN VERIFIED FOR MANUFACTURING AS AN END USER  
 PRODUCT. INTEL IS NOT RESPONSIBLE FOR THE  
 MISUSE OF THIS INFORMATION.

FILE	Mini PCI Connector
Doc Number	
Rev	D
Date	Thursday, February 26, 1999
Sheet	3 of 22

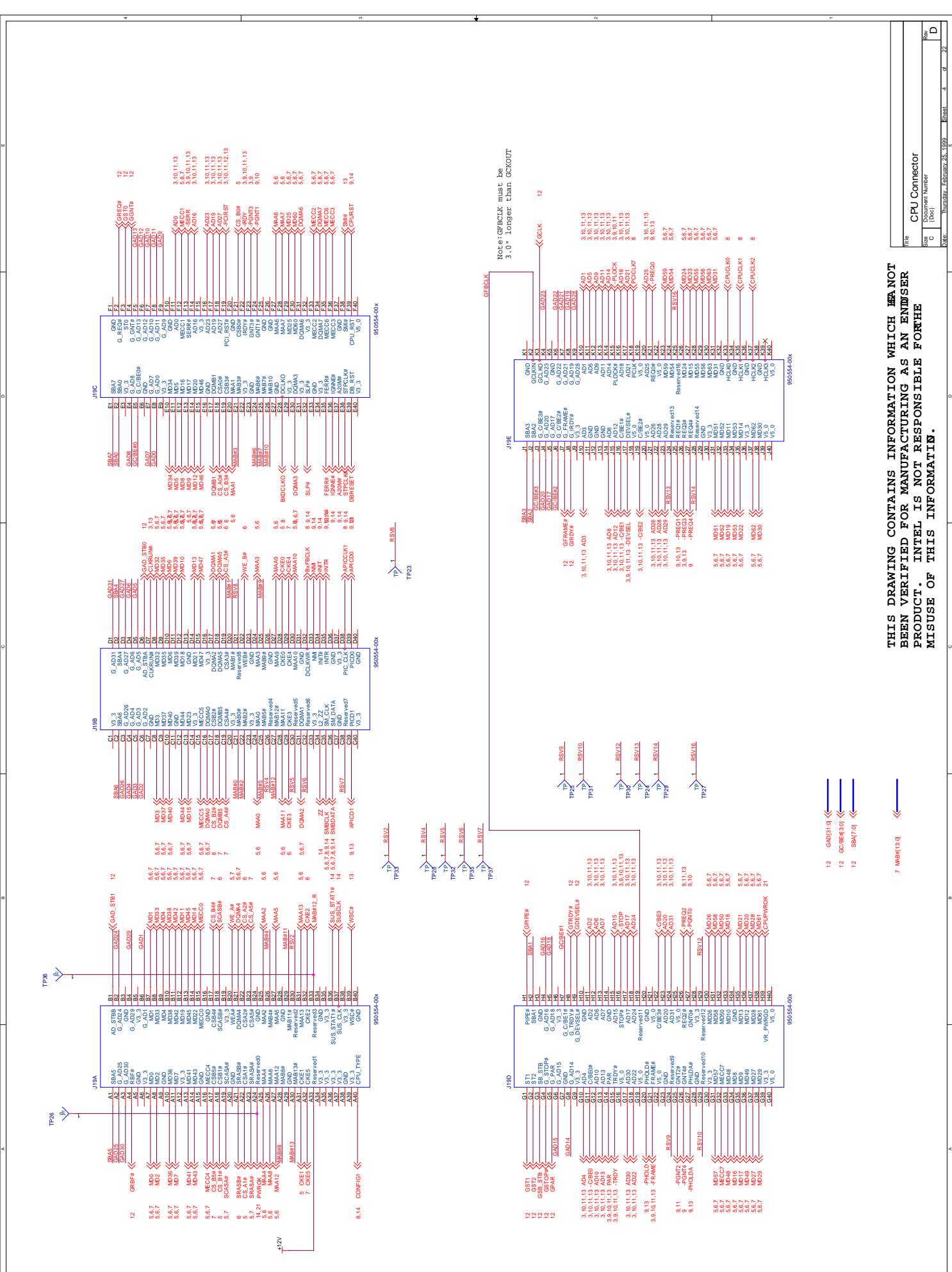

THIS DRAWING CONTAINS INFORMATION WHICH IS NOT BEEN VERIFIED FOR MANUFACTURING AS AN ENDUSER PRODUCT. INTEL IS NOT RESPONSIBLE FOR THE MISUSE OF THIS INFORMATION.

Rev	Document Number
1.0	950554-00X
2.0	
3.0	
4.0	
5.0	
6.0	
7.0	
8.0	
9.0	
10.0	
11.0	
12.0	

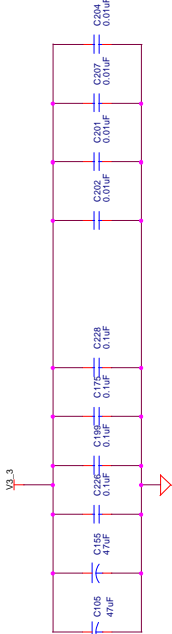

Socket 0

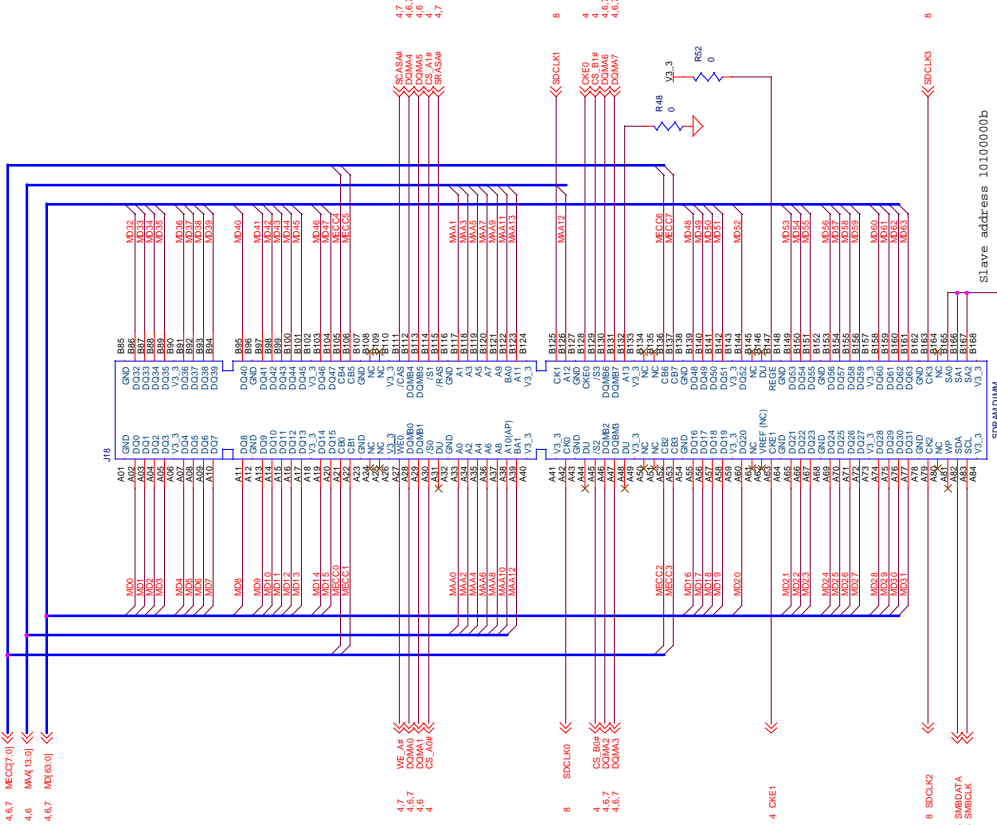

THIS DRAWING CONTAINS INFORMATION WHICH IS NOT  
 BEING VERIFIED FOR MANUFACTURING AS AN END USER  
 PRODUCT. INTEL IS NOT RESPONSIBLE FOR THE  
 MISUSE OF THIS INFORMATION.

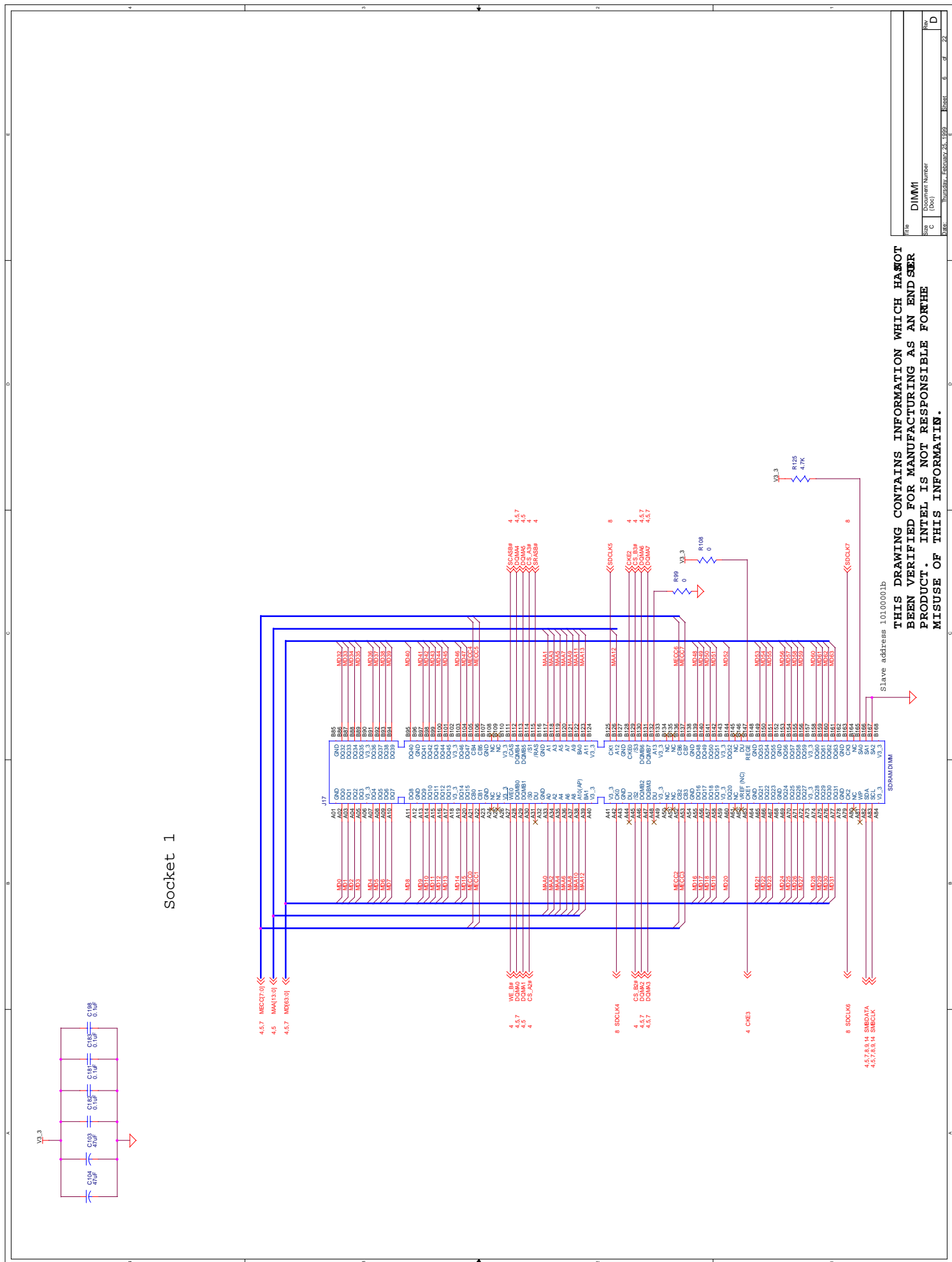

Socket 1

THIS DRAWING CONTAINS INFORMATION WHICH HAS NOT BEEN VERIFIED FOR MANUFACTURING AS AN END USER PRODUCT. INTEL IS NOT RESPONSIBLE FOR THE MISUSE OF THIS INFORMATION.

### Socket 2

Note: J16 is not populated

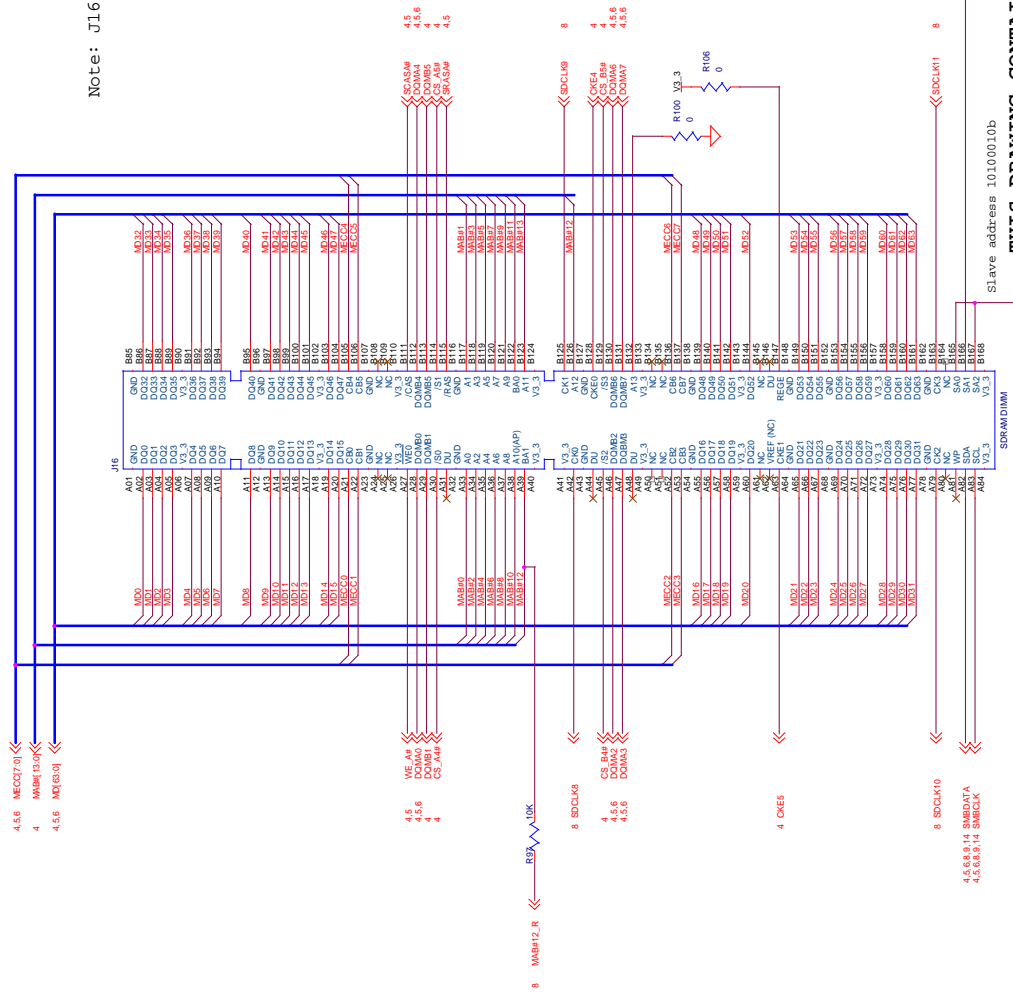
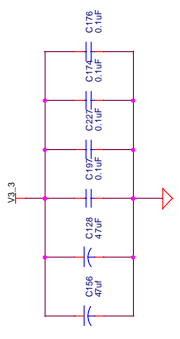

THIS DRAWING CONTAINS INFORMATION WHICH IS NOT BEEN VERIFIED FOR MANUFACTURING AS AN END USER PRODUCT. INTEL IS NOT RESPONSIBLE FOR THE MISUSE OF THIS INFORMATION.



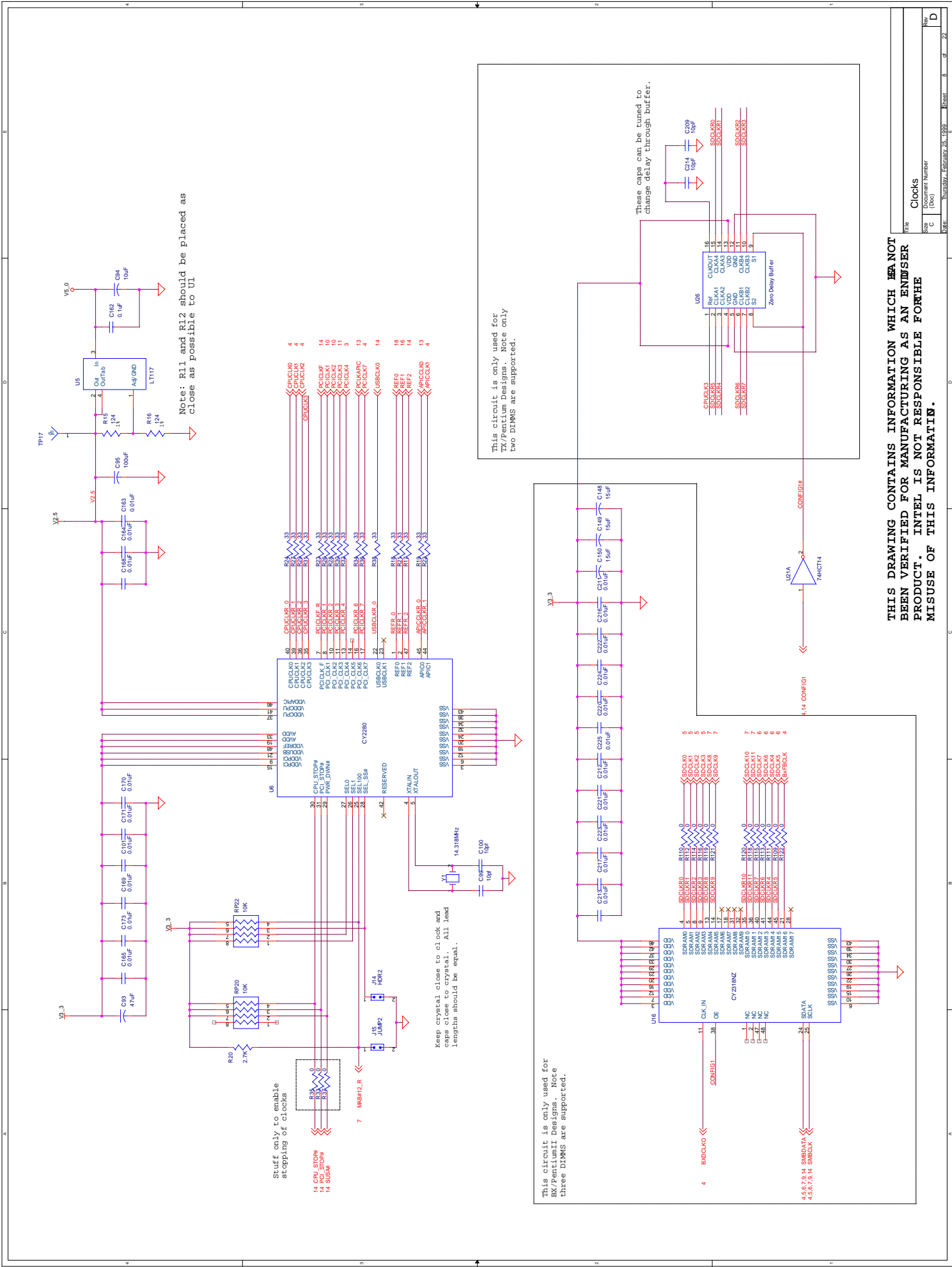

Note: R11 and R12 should be placed as close as possible to U1

Stuff only to enable stopping of clocks

Keep crystal close to clock and caps close to crystal. All lead lengths should be equal.

This circuit is only used for i7/Atom designs. Note only the three DIMMs are supported.

This circuit is only used for i7/Atom designs. Note only the two DIMMs are supported.

These caps can be tuned to change delay through buffer.

**THIS DRAWING CONTAINS INFORMATION WHICH IS NOT BEEN VERIFIED FOR MANUFACTURING AS AN END USER PRODUCT. INTEL IS NOT RESPONSIBLE FOR THE MISUSE OF THIS INFORMATION.**

ISA Pullups

PCI Pullups

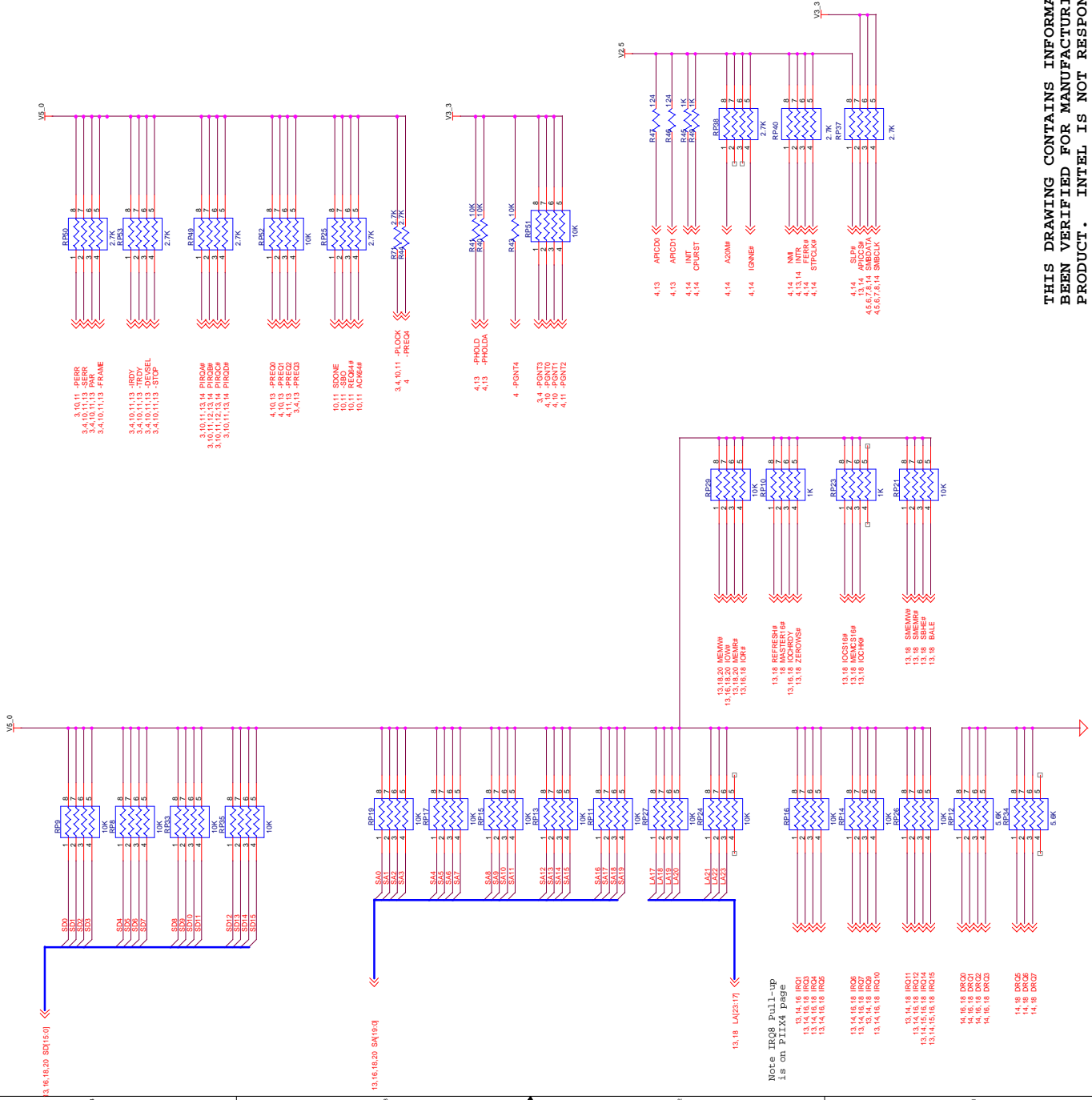

Note IR08 Pull-up  
is on PIIX4 page

THIS DRAWING CONTAINS INFORMATION WHICH HAS NOT  
BEEN VERIFIED FOR MANUFACTURING AS AN END USER  
PRODUCT. INTEL IS NOT RESPONSIBLE FOR THE  
MISUSE OF THIS INFORMATION.

J7/J8 V5\_0:  
 A5, A6, A10, A15, A59, A61, A62 | A1, A3, A4  
 B5, B6, B13, B22, B59, B61, B62

J7/J8 V3\_3:  
 A21, A27, A33, A39, A45, A53  
 B25, B31, B36, B41, B43, B54

J7/J8 NC:  
 A9, A11, A14, A19  
 B10, B14

J7/J8 GND:  
 A12, A13, A18, A24, A30, A35, A37, A42, A48, A56  
 B3, B12, B13, B15, B17, B28, B34, B38, B46, B49,  
 B57

J7/J8 +12V: A2  
 -12V: B1

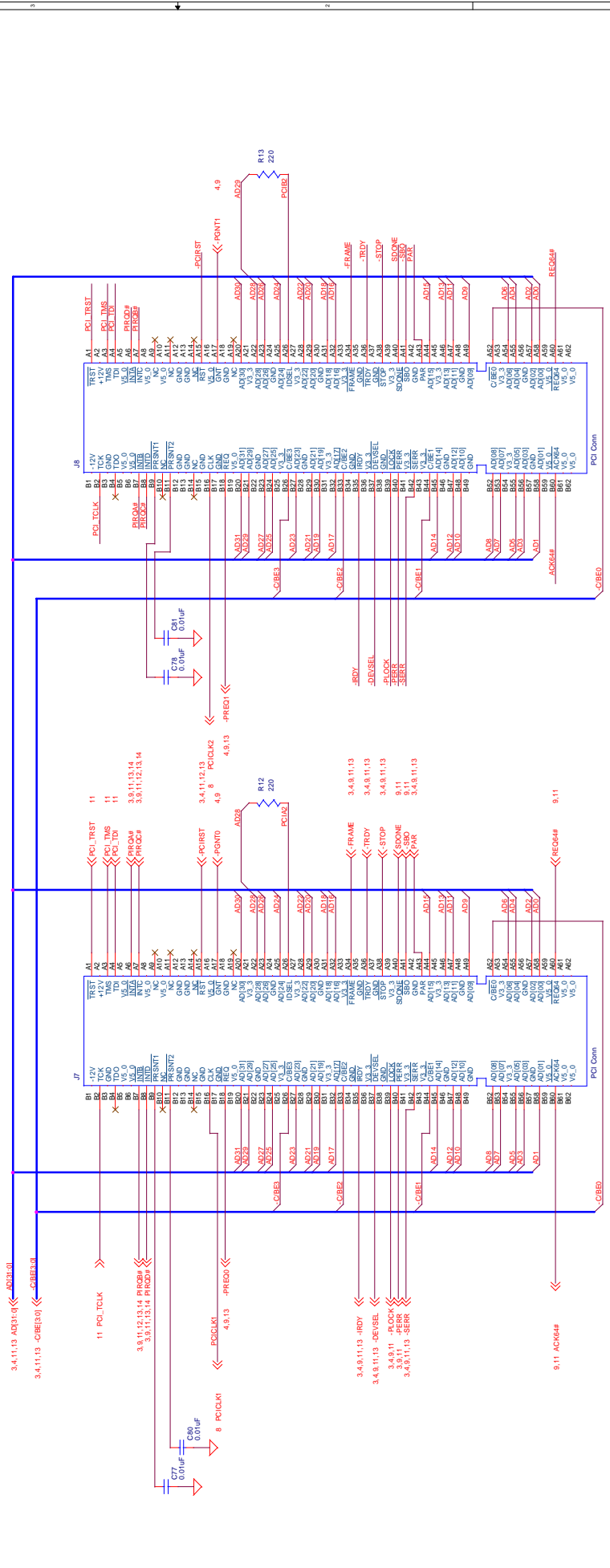
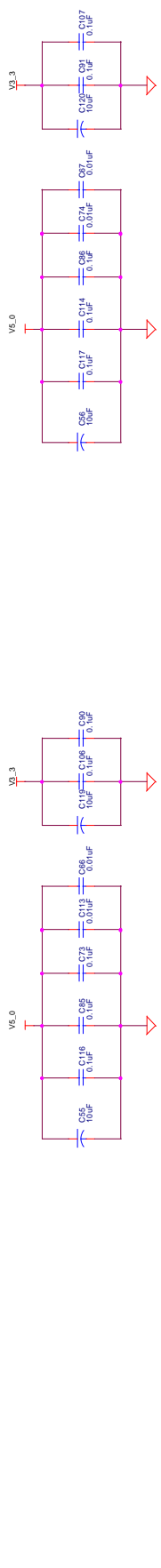

PCI SLOT 0

PCI SLOT 1

Pin	Signal	Header
1	PCIRST	J7/J8
2	PCIRST	J7/J8
3	PCIRST	J7/J8
4	PCIRST	J7/J8
5	PCIRST	J7/J8
6	PCIRST	J7/J8
7	PCIRST	J7/J8
8	PCIRST	J7/J8
9	PCIRST	J7/J8
10	PCIRST	J7/J8
11	PCIRST	J7/J8
12	PCIRST	J7/J8
13	PCIRST	J7/J8
14	PCIRST	J7/J8
15	PCIRST	J7/J8
16	PCIRST	J7/J8
17	PCIRST	J7/J8
18	PCIRST	J7/J8
19	PCIRST	J7/J8
20	PCIRST	J7/J8
21	PCIRST	J7/J8
22	PCIRST	J7/J8
23	PCIRST	J7/J8
24	PCIRST	J7/J8
25	PCIRST	J7/J8
26	PCIRST	J7/J8
27	PCIRST	J7/J8
28	PCIRST	J7/J8
29	PCIRST	J7/J8
30	PCIRST	J7/J8
31	PCIRST	J7/J8
32	PCIRST	J7/J8
33	PCIRST	J7/J8
34	PCIRST	J7/J8
35	PCIRST	J7/J8
36	PCIRST	J7/J8
37	PCIRST	J7/J8
38	PCIRST	J7/J8
39	PCIRST	J7/J8
40	PCIRST	J7/J8
41	PCIRST	J7/J8
42	PCIRST	J7/J8
43	PCIRST	J7/J8
44	PCIRST	J7/J8
45	PCIRST	J7/J8
46	PCIRST	J7/J8
47	PCIRST	J7/J8
48	PCIRST	J7/J8
49	PCIRST	J7/J8
50	PCIRST	J7/J8
51	PCIRST	J7/J8
52	PCIRST	J7/J8
53	PCIRST	J7/J8
54	PCIRST	J7/J8
55	PCIRST	J7/J8
56	PCIRST	J7/J8
57	PCIRST	J7/J8
58	PCIRST	J7/J8
59	PCIRST	J7/J8
60	PCIRST	J7/J8
61	PCIRST	J7/J8
62	PCIRST	J7/J8
63	PCIRST	J7/J8
64	PCIRST	J7/J8
65	PCIRST	J7/J8
66	PCIRST	J7/J8
67	PCIRST	J7/J8
68	PCIRST	J7/J8
69	PCIRST	J7/J8
70	PCIRST	J7/J8
71	PCIRST	J7/J8
72	PCIRST	J7/J8
73	PCIRST	J7/J8
74	PCIRST	J7/J8
75	PCIRST	J7/J8
76	PCIRST	J7/J8
77	PCIRST	J7/J8
78	PCIRST	J7/J8
79	PCIRST	J7/J8
80	PCIRST	J7/J8
81	PCIRST	J7/J8
82	PCIRST	J7/J8
83	PCIRST	J7/J8
84	PCIRST	J7/J8
85	PCIRST	J7/J8
86	PCIRST	J7/J8
87	PCIRST	J7/J8
88	PCIRST	J7/J8
89	PCIRST	J7/J8
90	PCIRST	J7/J8
91	PCIRST	J7/J8
92	PCIRST	J7/J8
93	PCIRST	J7/J8
94	PCIRST	J7/J8
95	PCIRST	J7/J8
96	PCIRST	J7/J8
97	PCIRST	J7/J8
98	PCIRST	J7/J8
99	PCIRST	J7/J8
100	PCIRST	J7/J8

THIS DRAWING CONTAINS INFORMATION WHICH IS NOT BEEN VERIFIED FOR MANUFACTURING AS AN END USER PRODUCT. INTEL IS NOT RESPONSIBLE FOR THE MISUSE OF THIS INFORMATION.

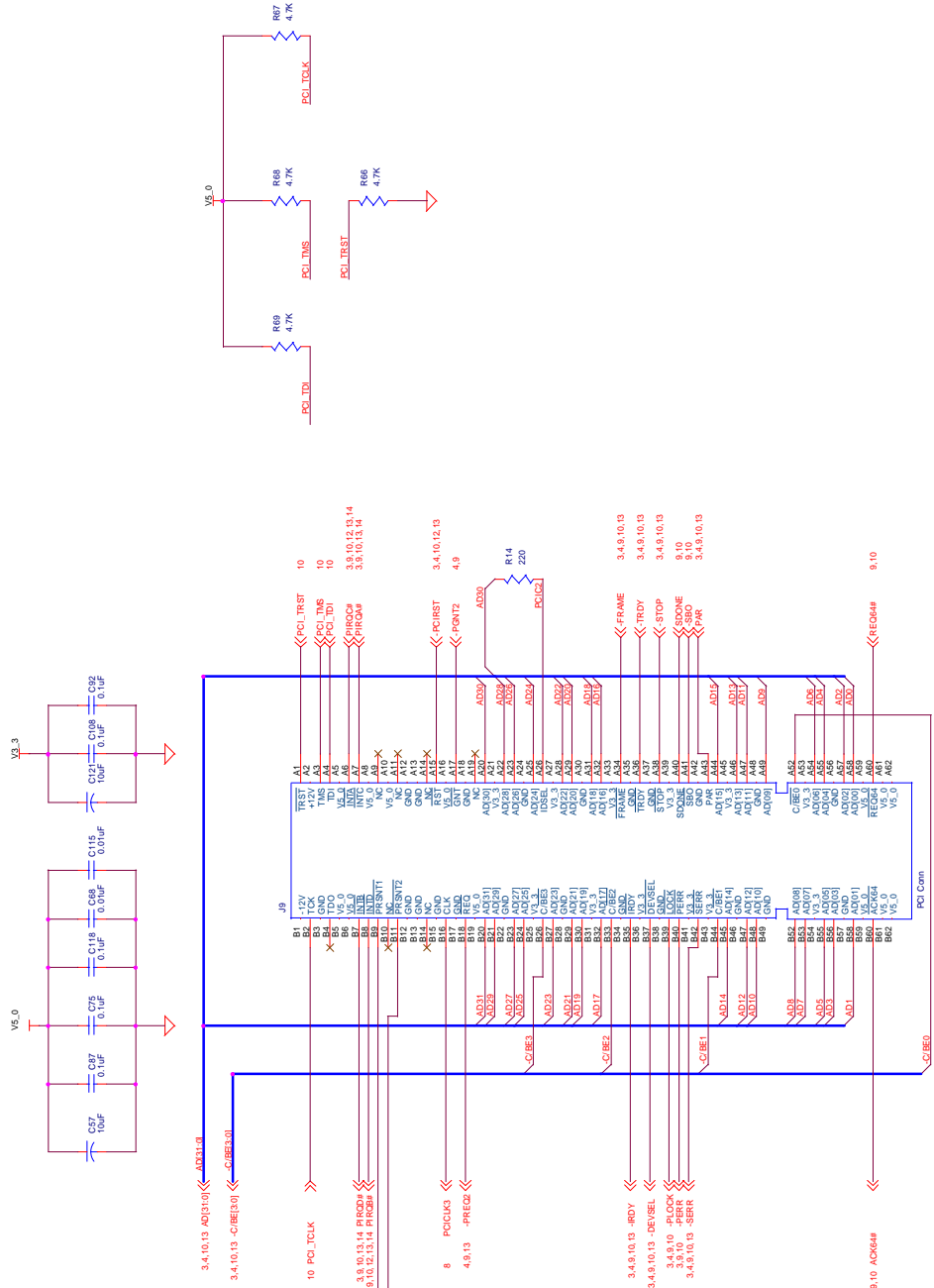

THIS DRAWING CONTAINS INFORMATION WHICH IS NOT BEEN VERIFIED FOR MANUFACTURING AS AN END USER PRODUCT. INTEL IS NOT RESPONSIBLE FOR THE MISUSE OF THIS INFORMATION.

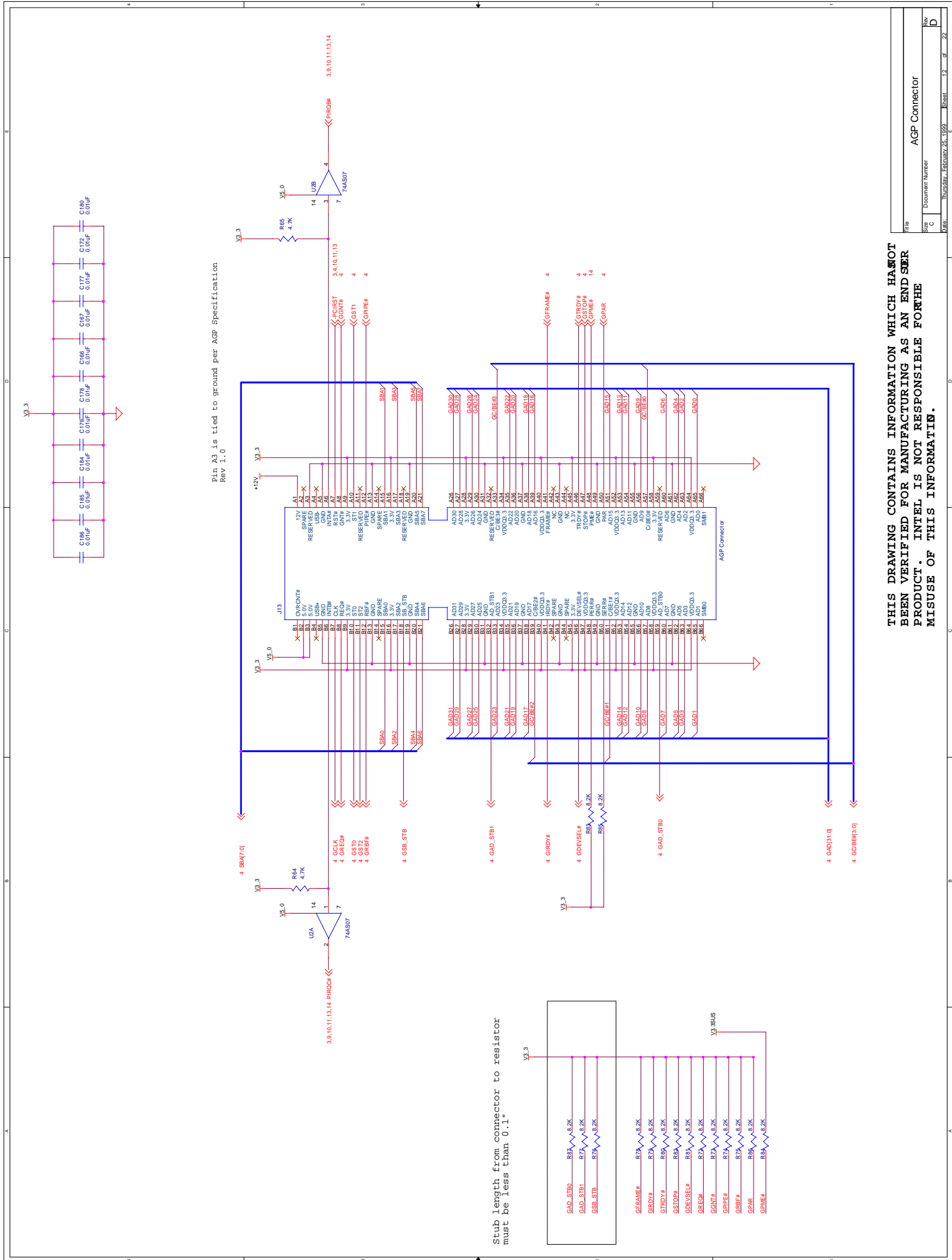

Pin A3 is tied to ground per AGP Specification  
Rev 1.0

Stub length from connector to resistor must be less than 0.1"

**THIS DRAWING CONTAINS INFORMATION WHICH HAS NOT BEEN VERIFIED FOR MANUFACTURING AS AN END USER PRODUCT. INTEL IS NOT RESPONSIBLE FOR THE MISUSE OF THIS INFORMATION.**

File	AGP Connector
Doc	Document Number
Rev	D
Date	Thursday, February 25, 1999
Sheet	12 of 22

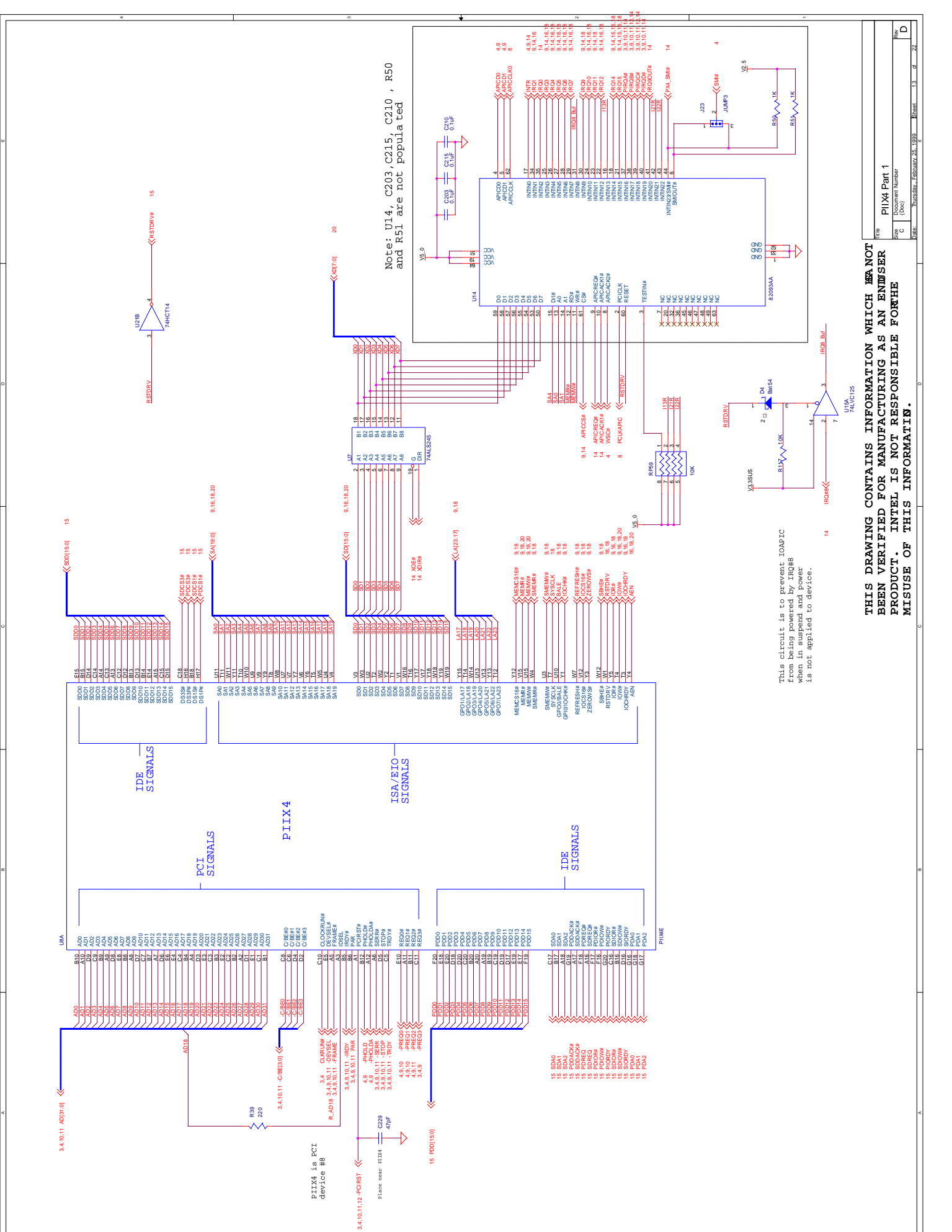

Note: U14, C203, C215, C210, R50 and R51 are not populated

This circuit is to prevent IOAPIC from being powered by IRQ#8 when in suspend and power is not applied to device.

**THIS DRAWING CONTAINS INFORMATION WHICH IS NOT BEEN VERIFIED FOR MANUFACTURING AS AN ENDUSER PRODUCT. INTEL IS NOT RESPONSIBLE FOR THE MISUSE OF THIS INFORMATION.**

File	PIIX4 Part 1
Doc Number	
Rev	D
Date	Thursday, February 26, 1999
Sheet	13 of 22



### Primary IDE Connector

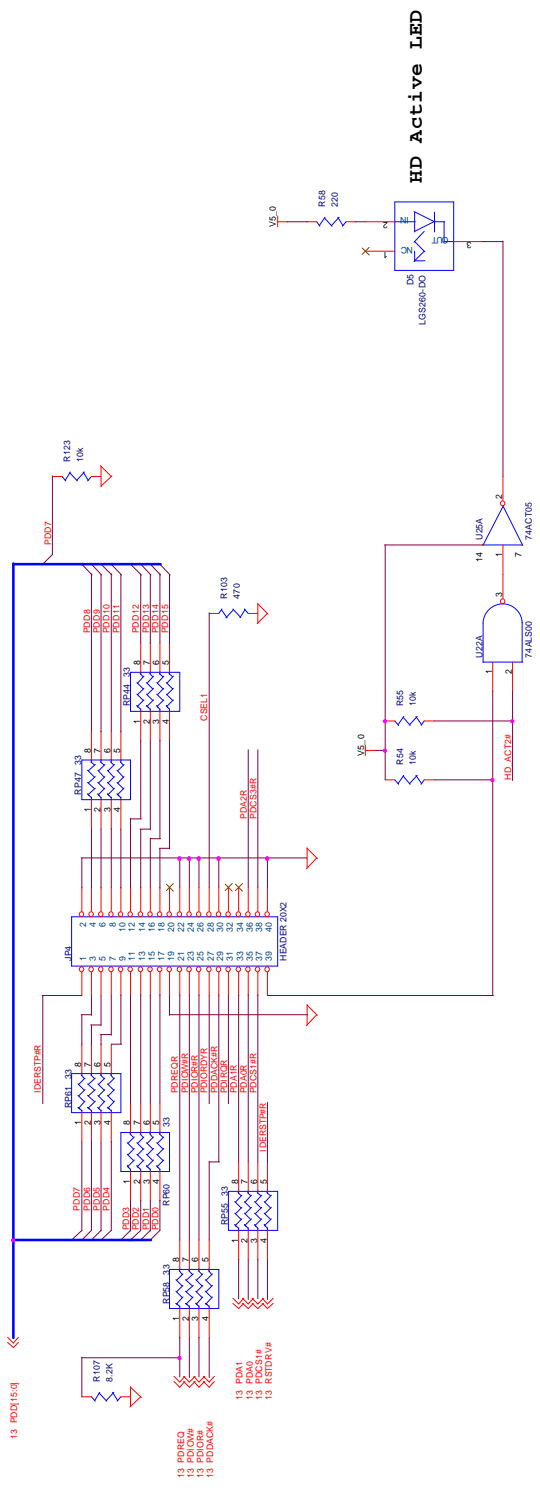

### Secondary IDE Connector

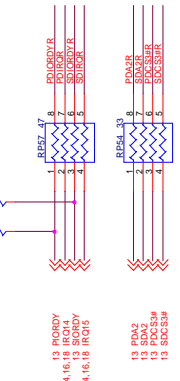
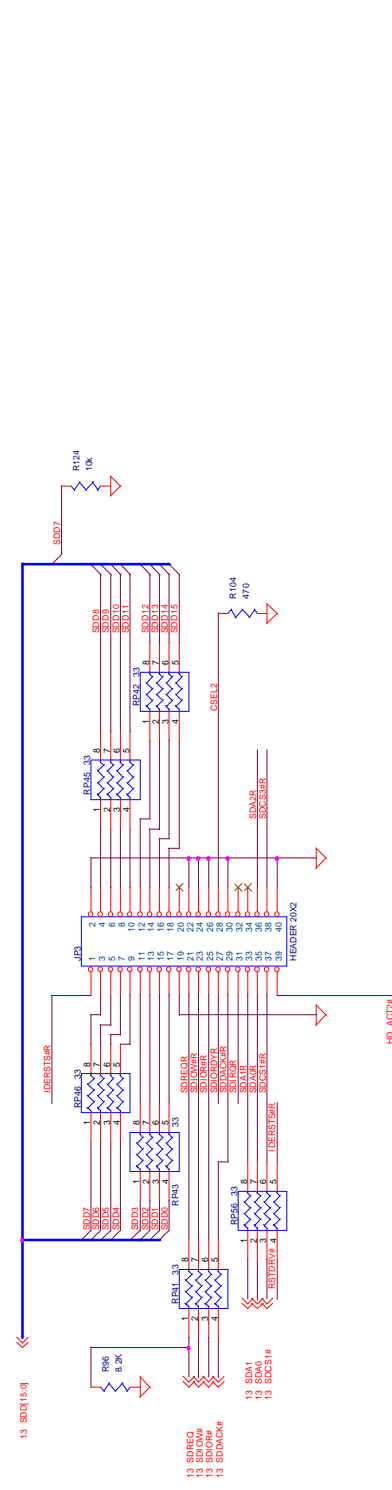

THIS DRAWING CONTAINS INFORMATION WHICH IS NOT BEEN VERIFIED FOR MANUFACTURING AS AN END USER PRODUCT. INTEL IS NOT RESPONSIBLE FOR THE MISUSE OF THIS INFORMATION.

Rev	IDE Connectors
Doc	Document Number
Rev	D
Date	Thursday, February 26, 1999
Sheet	13 of 22



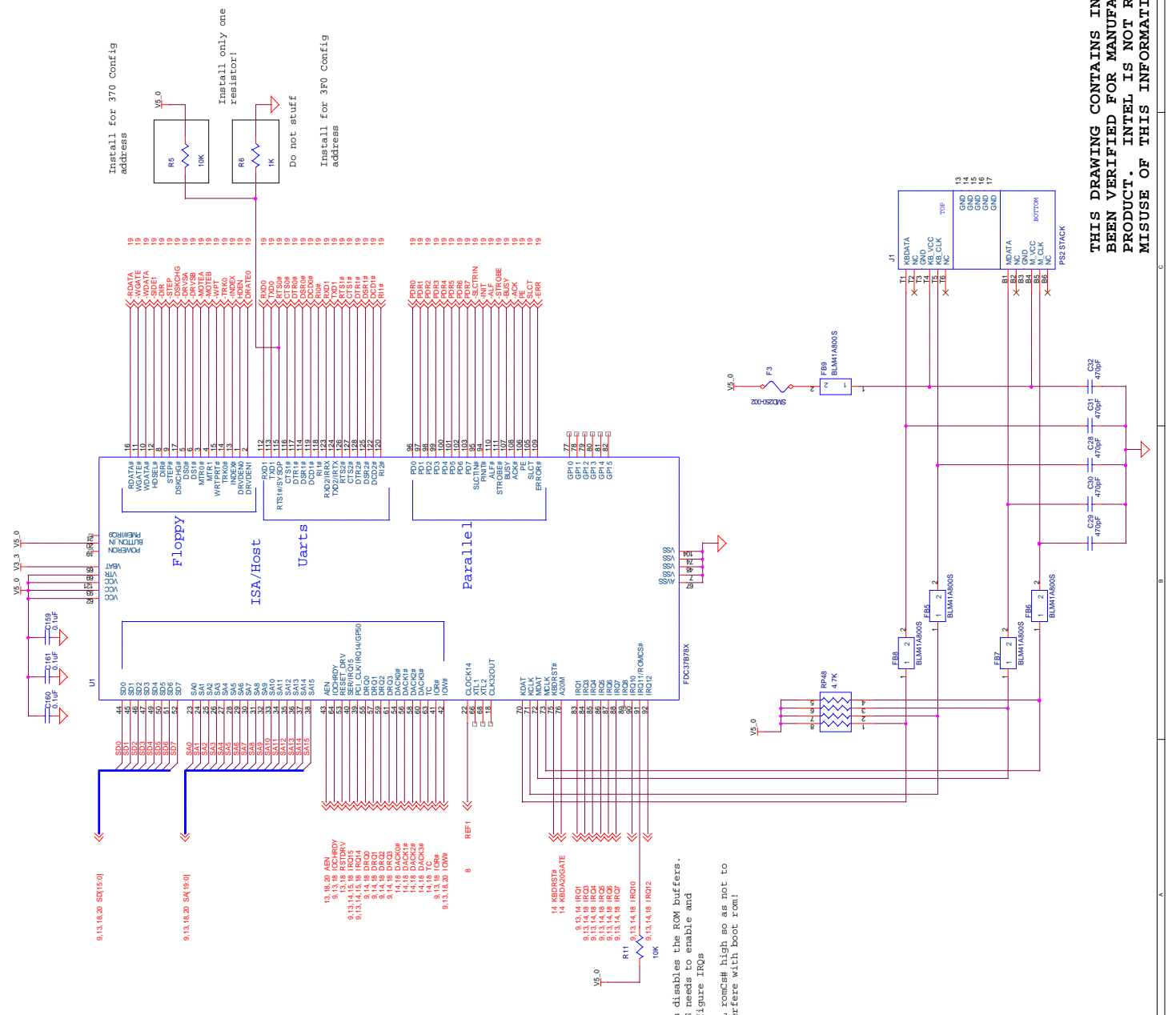

Install for 370 Config  
address

Install only one  
resistor!

Do not stuff

Install for 3F0 Config  
address

This disables the ROM buffers.  
BIOS needs to enable and  
configure IRQs

PULL romCsh high so as not to  
interfere with boot rom!

**THIS DRAWING CONTAINS INFORMATION WHICH HAS NOT  
BEEN VERIFIED FOR MANUFACTURING AS AN ENDUSER  
PRODUCT. INTEL IS NOT RESPONSIBLE FOR THE  
MISUSE OF THIS INFORMATION.**

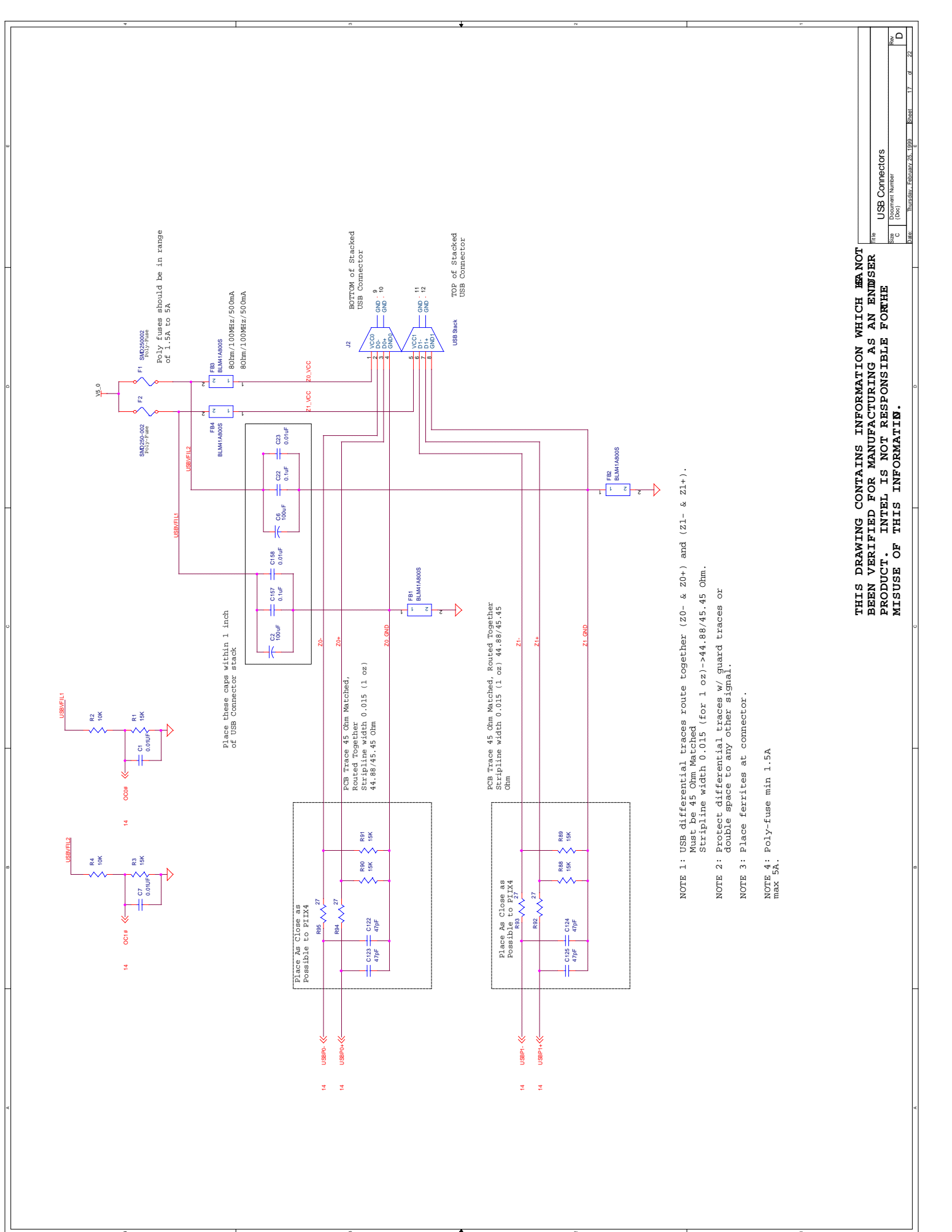

Poly fuses should be in range of 1.5A to 5A

Place these caps within 1 inch of USB Connector stack

Place As Close as Possible to PIX4

PCB Trace 45 Ohm Matched, Routed Together Stripline width 0.015 (1 oz) 44.88/45.45 Ohm

PCB Trace 45 Ohm Matched, Routed Together Stripline width 0.015 (1 oz) 44.88/45.45 Ohm

Place As Close as Possible to PIX4

NOTE 1: USB differential traces route together (Z0- & Z0+) and (Z1- & Z1+). Must be 45 Ohm Matched Stripline width 0.015 (for 1 oz)->44.88/45.45 Ohm.

NOTE 2: Protect differential traces w/ guard traces or double space to any other signal.

NOTE 3: Place ferrites at connector.

NOTE 4: Poly-fuse min 1.5A max 5A.

THIS DRAWING CONTAINS INFORMATION WHICH IS NOT BEEN VERIFIED FOR MANUFACTURING AS AN END USER PRODUCT. INTEL IS NOT RESPONSIBLE FOR THE MISUSE OF THIS INFORMATION.

File	USB Connectors
Doc Number	
Rev	D
Date	Thursday, February 26, 1999
Sheet	17 of 22

# ISA Slots

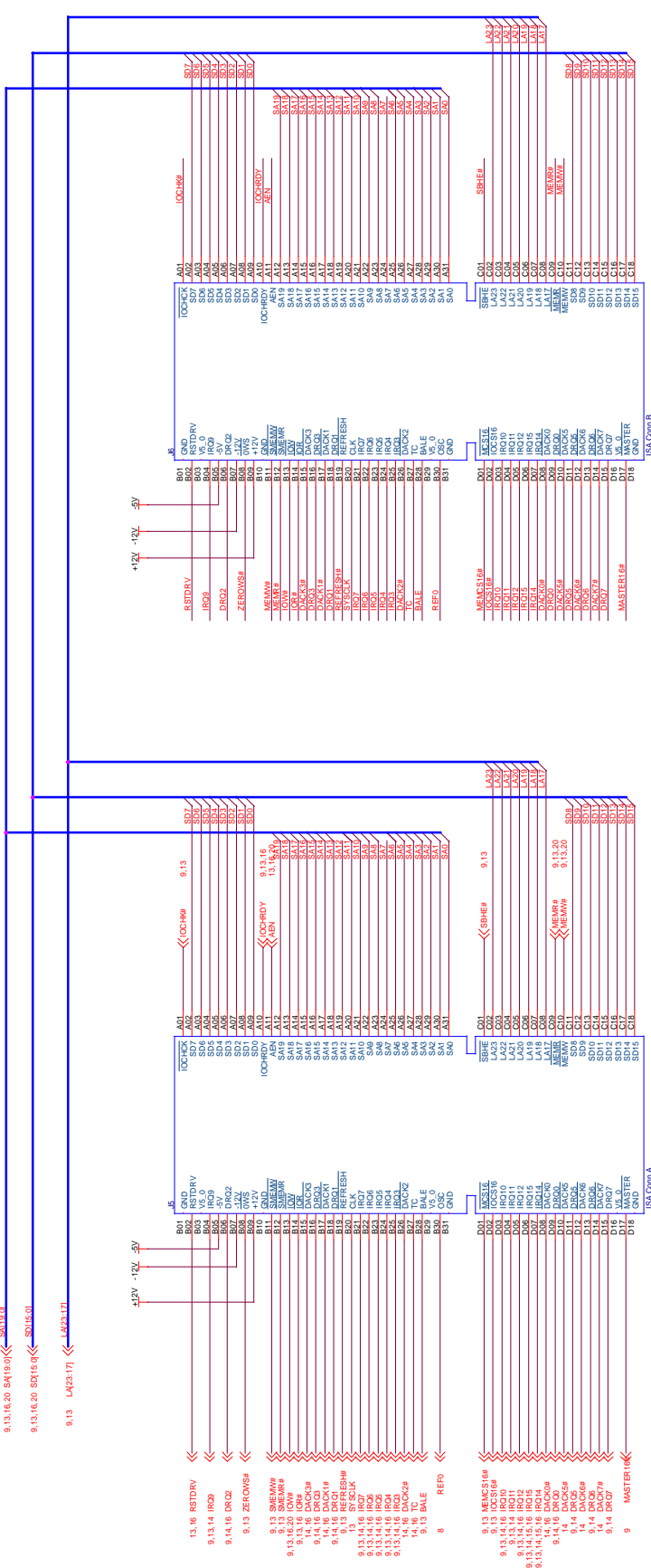
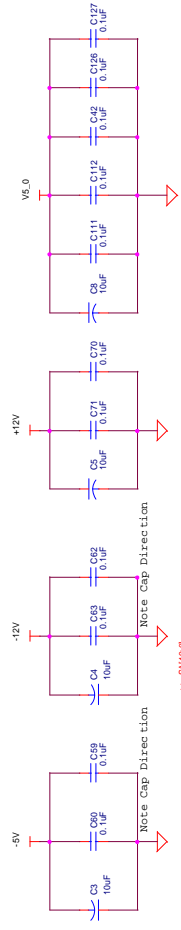

J5/J6 V5\_0:  
 B03, B29, B31, D16

J5/J6 GND:  
 B01, B10, D18

J5/J6: +12V B09  
 -12V B07  
 -5V B05

**THIS DRAWING CONTAINS INFORMATION WHICH HAS NOT BEEN VERIFIED FOR MANUFACTURING AS AN END USER PRODUCT. INTEL IS NOT RESPONSIBLE FOR THE MISUSE OF THIS INFORMATION.**

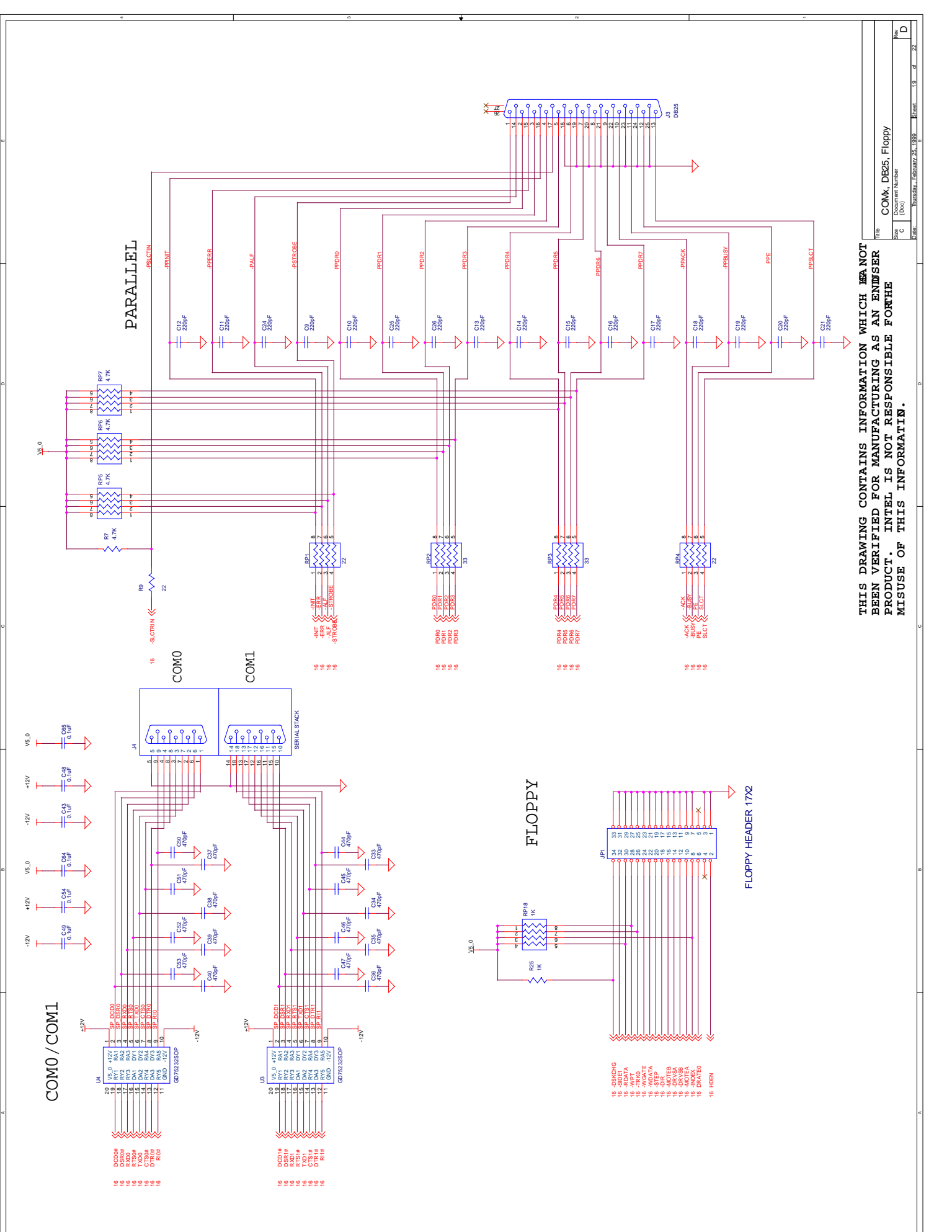

THIS DRAWING CONTAINS INFORMATION WHICH IS NOT  
 BEEN VERIFIED FOR MANUFACTURING AS AN ENDUSER  
 PRODUCT. INTEL IS NOT RESPONSIBLE FOR THE  
 MISUSE OF THIS INFORMATION.

FILE	COM1, DB25, Floppy
Docuement Number	
Rev	D
Date	Thursday, February 26, 1989
Sheet	13 of 22

Port 80

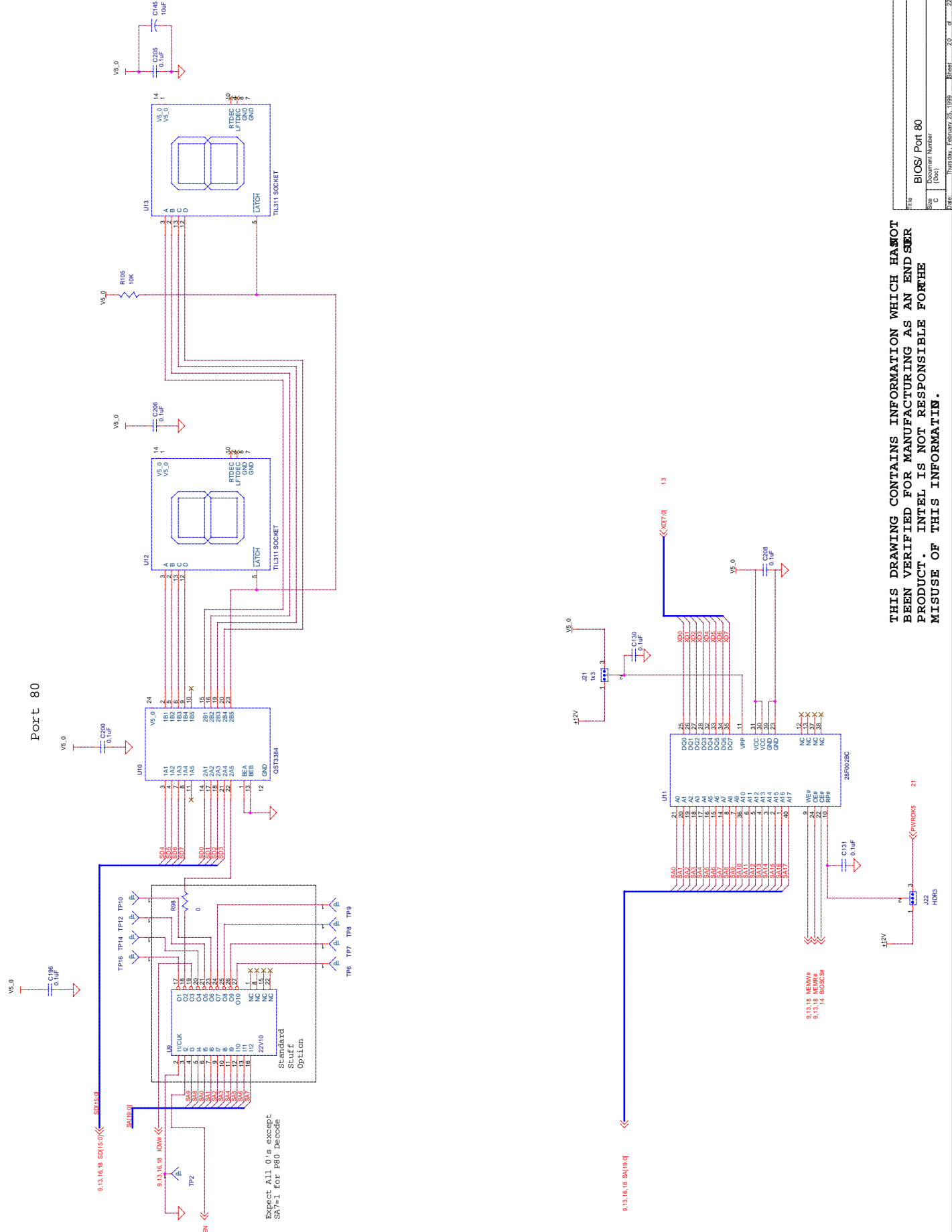

THIS DRAWING CONTAINS INFORMATION WHICH HAS NOT BEEN VERIFIED FOR MANUFACTURING AS AN END USER PRODUCT. INTEL IS NOT RESPONSIBLE FOR THE MISUSE OF THIS INFORMATION.

Power Indicators

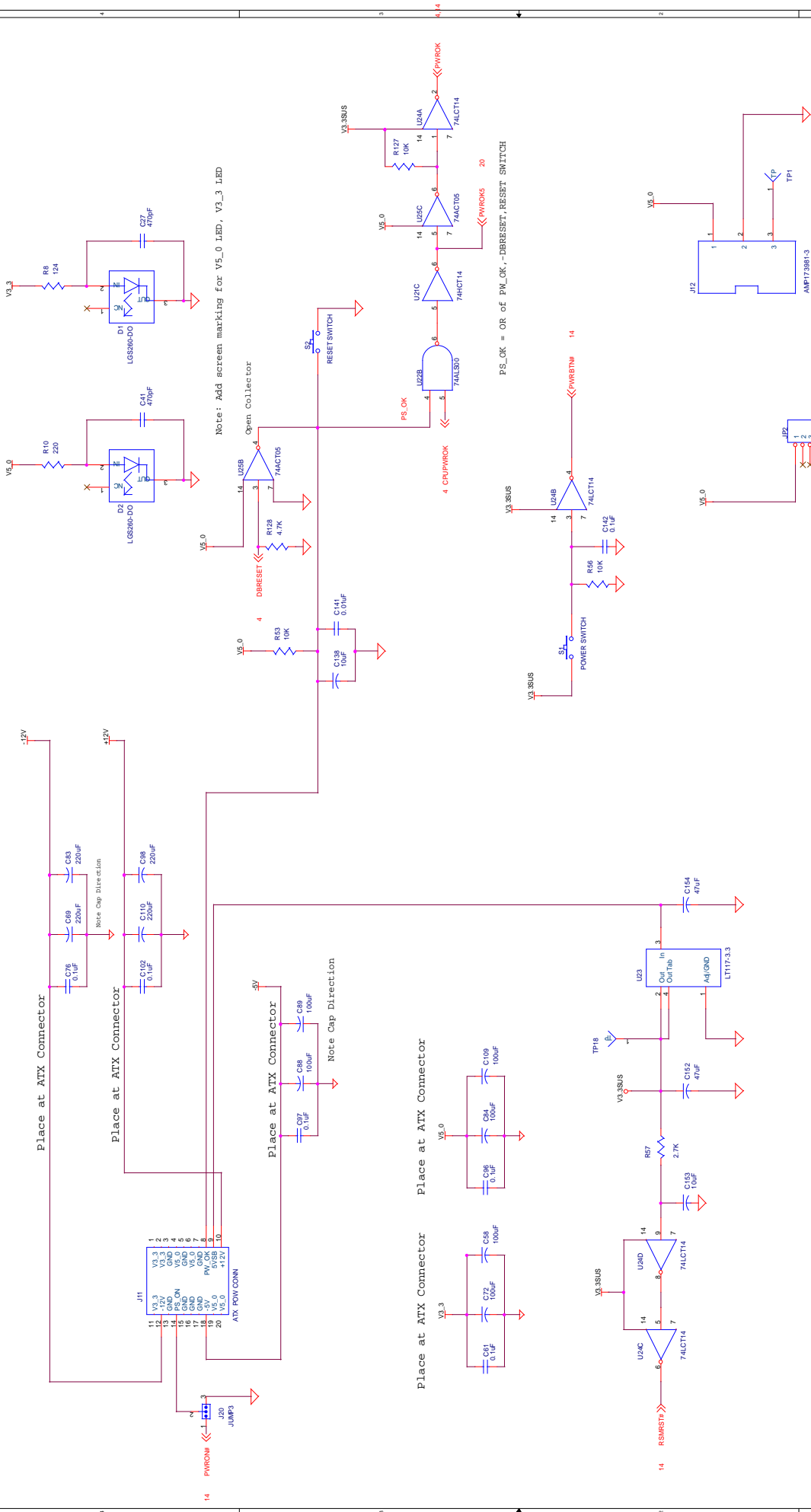

Note: Add screen marking for V5\_0 LED, V3\_3 LED

Note Cap Direction

Note Cap Direction

PS\_OK = OR of PM\_OK, DBRESET, RESET SWITCH

SPEAKER HEADER

THIS DRAWING CONTAINS INFORMATION WHICH ~~IS~~ NOT BEEN VERIFIED FOR MANUFACTURING AS AN ENDUSER PRODUCT. INTEL IS NOT RESPONSIBLE FOR THE MISUSE OF THIS INFORMATION.

File	AXT Power Connector
Doc Number	
Rev	D
Date	Thursday, February 26, 1999
Sheet	21 of 22

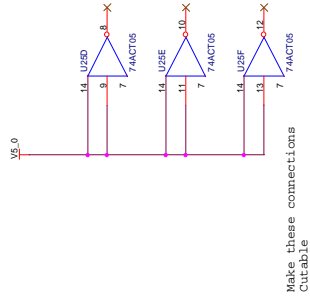
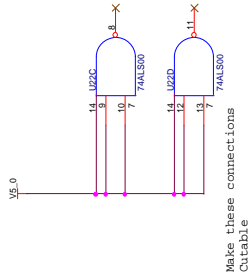
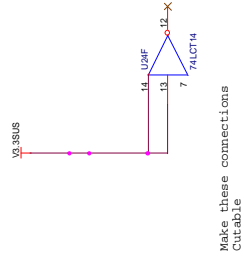
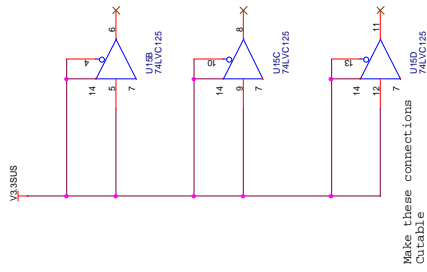
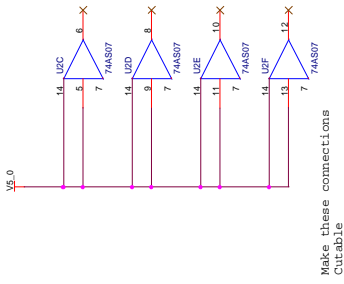
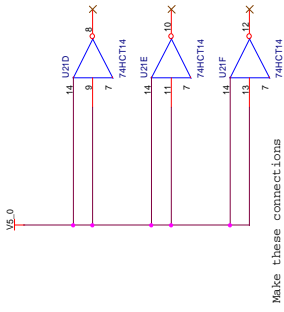

**THIS DRAWING CONTAINS INFORMATION WHICH IS NOT  
 BEEN VERIFIED FOR MANUFACTURING AS AN END USER  
 PRODUCT. INTEL IS NOT RESPONSIBLE FOR THE  
 MISUSE OF THIS INFORMATION.**

# Celeron (TM) Processor in PPGA Daughter Board

## Revision A1

### History

REV A0 to REV A1 Changes

1. Removed Translator logic for PREQ0#
2. Removed Termination Resistors on BX side for GTL+
3. Added 20pF load on HCLK for BX clock compensating

No license, express or implied, by estoppel or otherwise, to any intellectual property rights is granted herein.

Intel disclaims all liability, including liability for infringement of any proprietary rights, relating to use of information in this specification. Intel does not warrant or represent that such use will not infringe such rights.

THIS SCHEMATIC IS PROVIDED "AS IS" WITH NO WARRANTIES WHATSOEVER, INCLUDING ANY WARRANTY OF MERCHANTABILITY, FITNESS FOR ANY PARTICULAR PURPOSE, OR ANY WARRANTY OTHERWISE ARISING OUT OF PROPOSAL, SPECIFICATION OR SAMPLE.

THIS DRAWING CONTAINS INFORMATION WHICH HAS NOT BEEN VERIFIED FOR MANUFACTURING AS AN END USER PRODUCT. INTEL IS NOT RESPONSIBLE FOR THE MISUSE OF THIS INFORMATION.

Intel Corporation

3000 W. Chandler Blvd  
Chandler, AZ, 85044

Title Page / Revision

Doc  
Number  
0200000000

Rev  
A

Date: 10/28/94

Sheet 1 of 1



ITP  
Bus Ratio  
Logic  
Thermal Sensor  
Page 10

Socket 370  
Page 3&4

GTL+  
Termination  
Page 5 & 6

GTL+

CPU  
Connector  
Page 9

440BX  
Page 7&8

PCI Bus  
AGP Bus  
SDRAM  
Interface

SMBus

Voltage  
Regulator  
Page 11

THIS SCHEMATIC IS PROVIDED "AS IS" WITH NO WARRANTIES WHATSOEVER, INCLUDING ANY WARRANTY OF MERCHANTABILITY, FITNESS FOR ANY PARTICULAR PURPOSE, OR ANY WARRANTY OTHERWISE ARISING OUT OF PROPOSAL, SPECIFICATION OR SAMPLE.

Freescale Microcontroller Division (EMD)

Intel Corporation  
4000 W. Chanhale Blvd  
Chandler, AZ, 85044

Title

Diagram

Docuement Number

00000000000000000000

Rev

1

Sheet

2

of 2

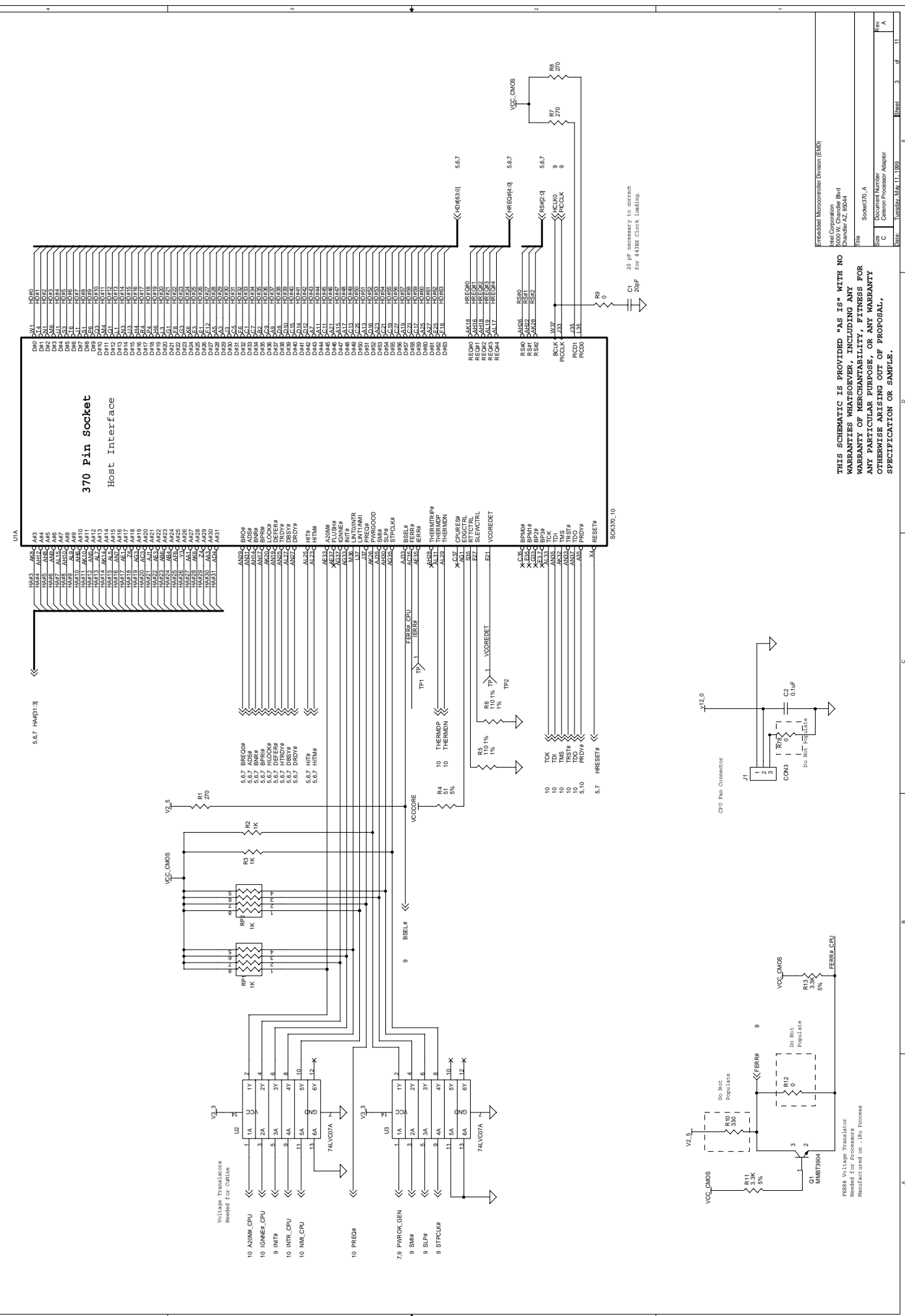

### 370 Pin Socket Power Supply

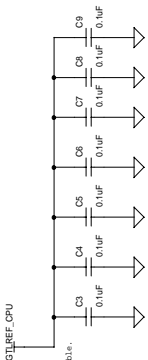
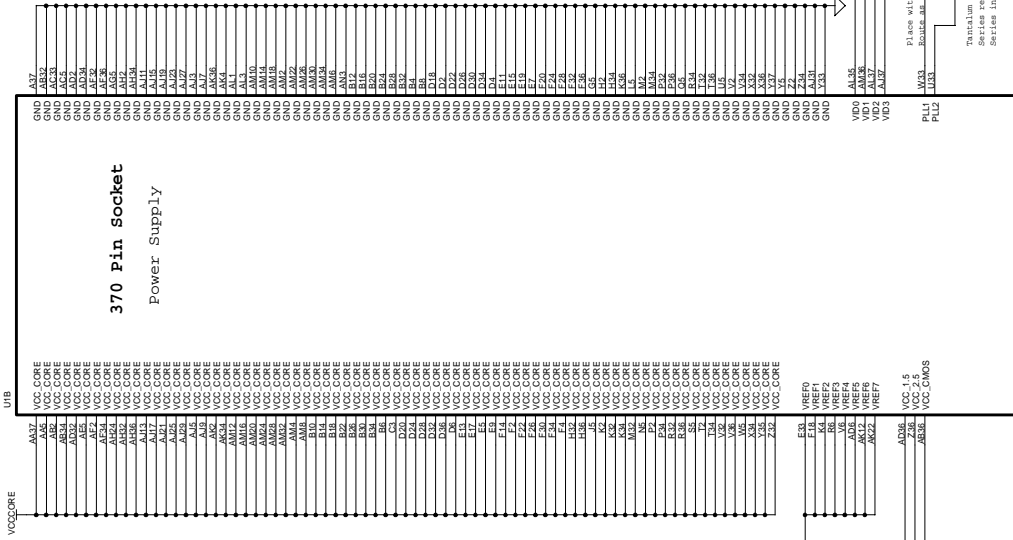

\*\*REFERENCE VOLTAGE FOR PROCESSOR, THERE  
MAY BE DIFFERENT VALUE FOR CONNECTION  
MAY BE DIFFERENT VALUE FOR PIN.

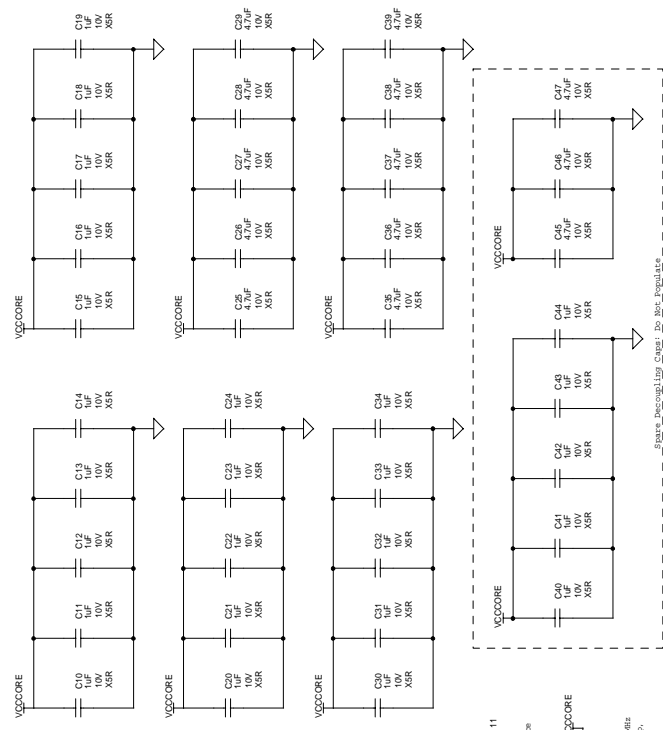

Share Decoupling Cap. Do Not Regulate

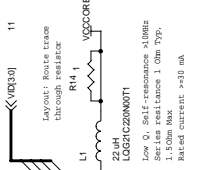

Low Q, self-resonance >10MHz  
Series resistance 1 Ohm Typ.  
1.500m Max.  
Rated current >=30 mA

SDC076.10

**THIS DRAWING CONTAINS INFORMATION WHICH HAS NOT  
BEEN VERIFIED FOR MANUFACTURING AS AN END USER  
PRODUCT. INTEL IS NOT RESPONSIBLE FOR THE  
MISUSE OF THIS INFORMATION.**

Freescale Microcontroller Division (EMD)

Intel Corporation  
8000 W. Chandler Blvd  
Chandler, AZ, 85044

File	Socket370_B
Doc Number	370
Doc Title	370 Pin Socket Power Supply
Rev	1
Sheet	1 of 1

**GTL+ TERMINATION  
RESISTORS-BX**

Resistor Packs placed for Dual End Termination.  
Not used on Celeron Processor in PPGA package with  
Single End Termination.

**THIS DRAWING CONTAINS INFORMATION WHICH HAS NOT  
BEEN VERIFIED FOR MANUFACTURING AS AN END USER  
PRODUCT. INTEL IS NOT RESPONSIBLE FOR THE  
MISUSE OF THIS INFORMATION.**

Intel Corporation  
8000 W. Chandler Blvd  
Chandler, AZ, 85244

Title: GTL+ Termination

Documnt Number: 280001-0000  
Change Order: 0000000000

Rev: 1

Sheet: 1 of 1

Date: 09/08/1999

**GTL+ TERMINATION  
RESISTORS-CPU**

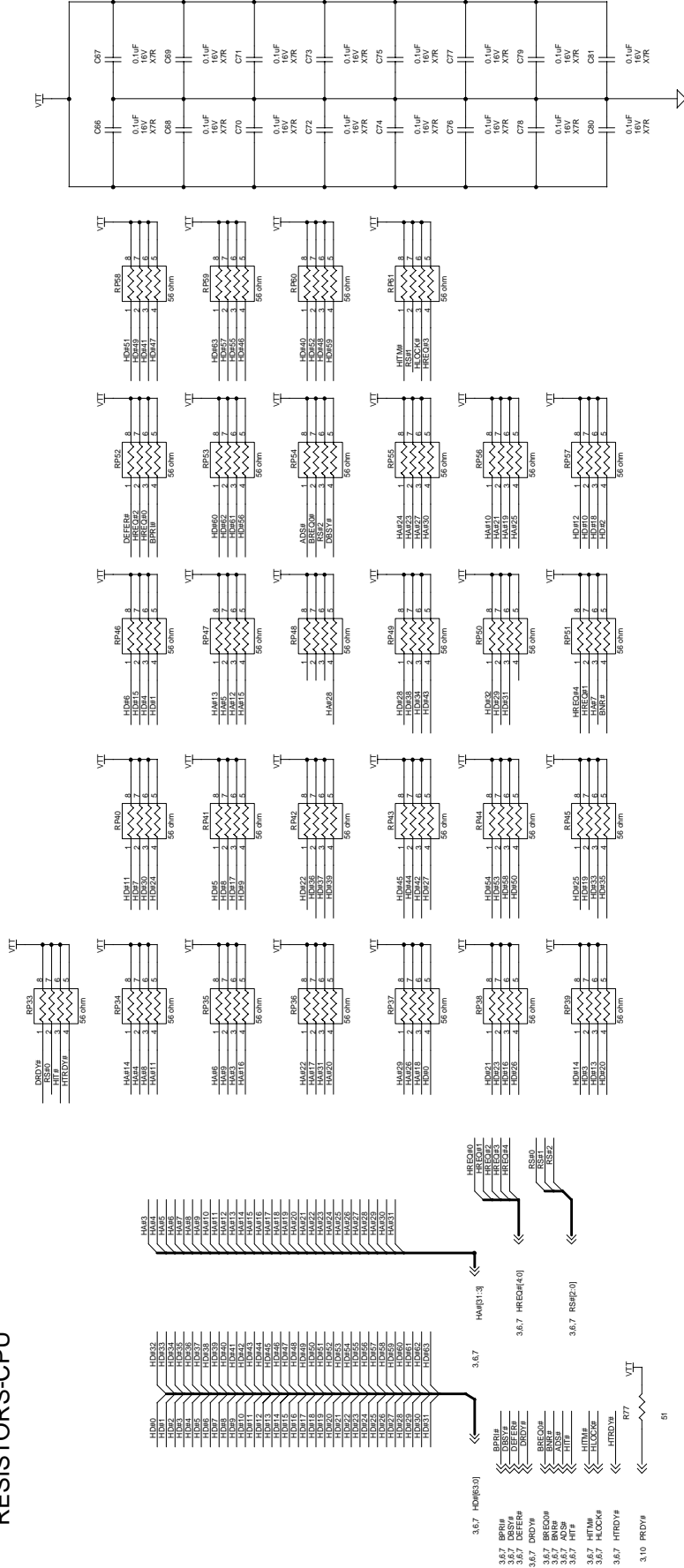

**NOTE : VTT = TERMINATION  
VOLTAGE**

**THIS DRAWING CONTAINS INFORMATION WHICH HAS NOT  
BEEN VERIFIED FOR MANUFACTURING AS AN END USER  
PRODUCT. INTEL IS NOT RESPONSIBLE FOR THE  
MISUSE OF THIS INFORMATION.**

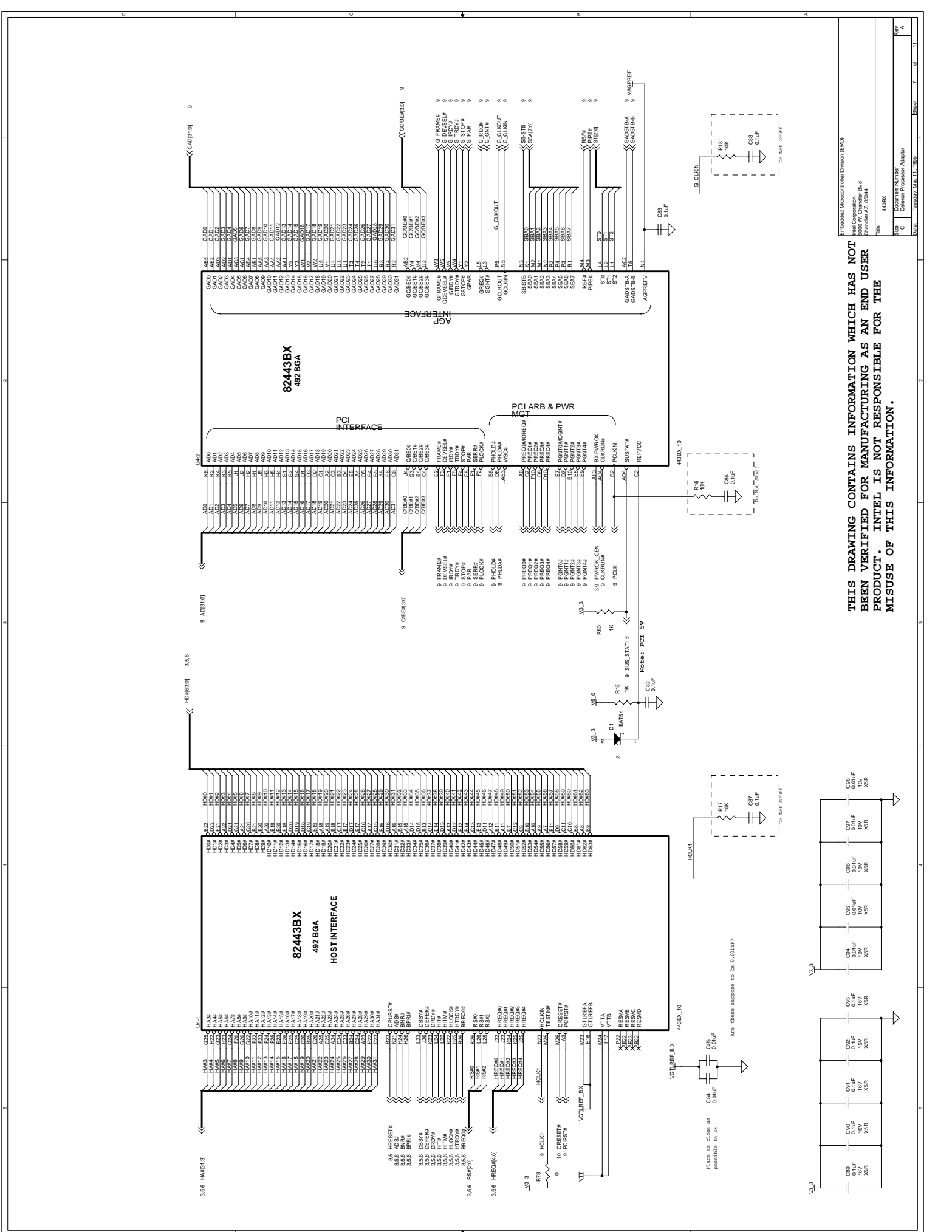

**THIS DRAWING CONTAINS INFORMATION WHICH HAS NOT BEEN VERIFIED FOR MANUFACTURING AS AN END USER PRODUCT. INTEL IS NOT RESPONSIBLE FOR THE MISUSE OF THIS INFORMATION.**

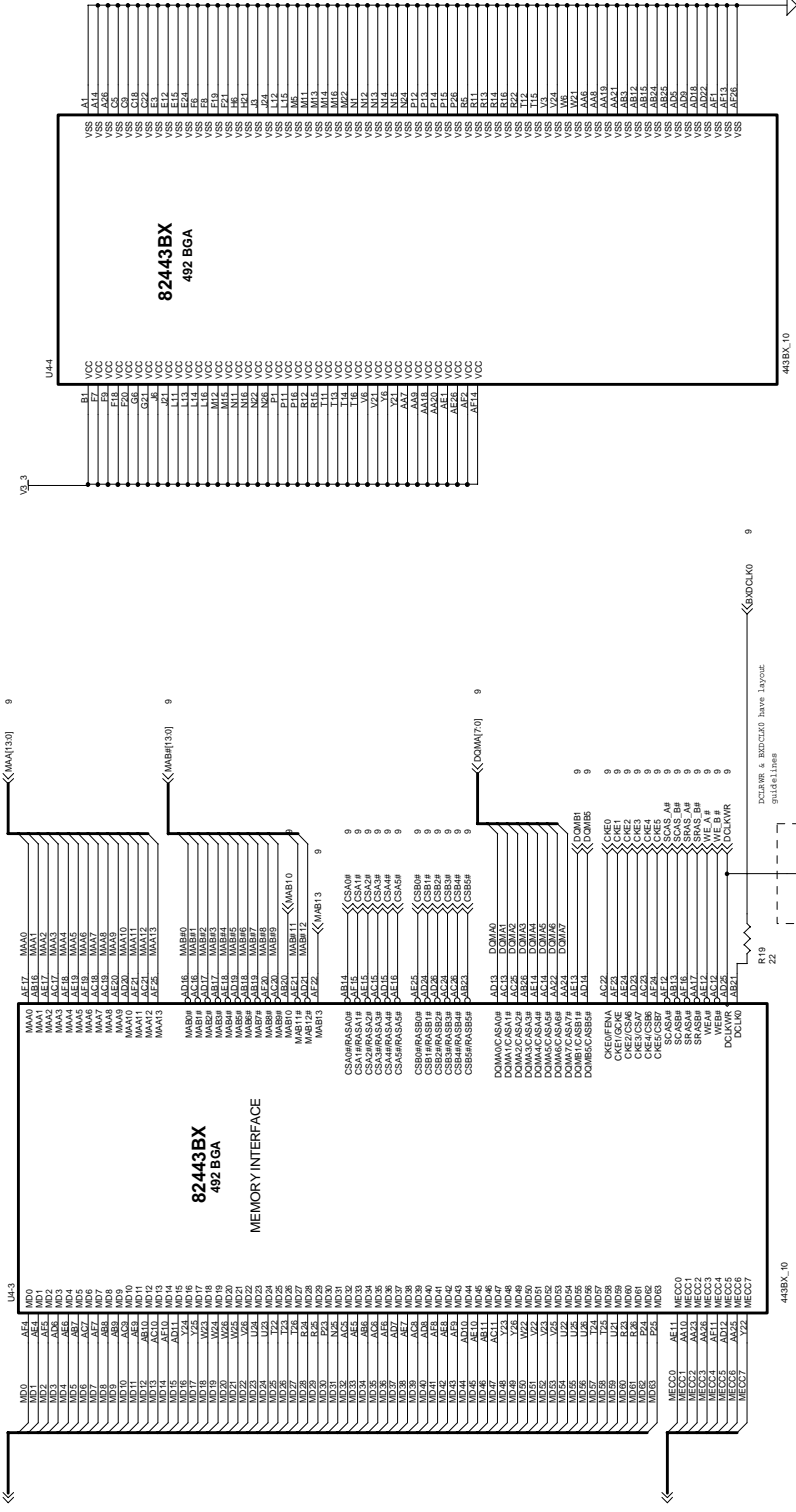

### BX Strapping Options

Reference	Function	Reset Default Setting	Signal
R21	Quick Start Select	Do Not Stuff	MAB10
R22	AMP Disable	Do Not Stuff	MAB9
R23	Memory Roamle	Do Not Stuff	MAB7
R24	Short Bus Buffer B0B3	Do Not Stuff	MAB6
R25	Enable Queue Impl3	Do Not Stuff	MAB11

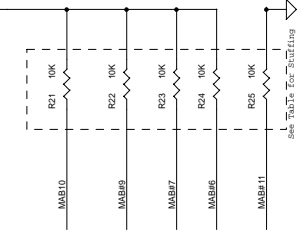

**THIS DRAWING CONTAINS INFORMATION WHICH HAS NOT BEEN VERIFIED FOR MANUFACTURING AS AN END USER PRODUCT. INTEL IS NOT RESPONSIBLE FOR THE MISUSE OF THIS INFORMATION.**

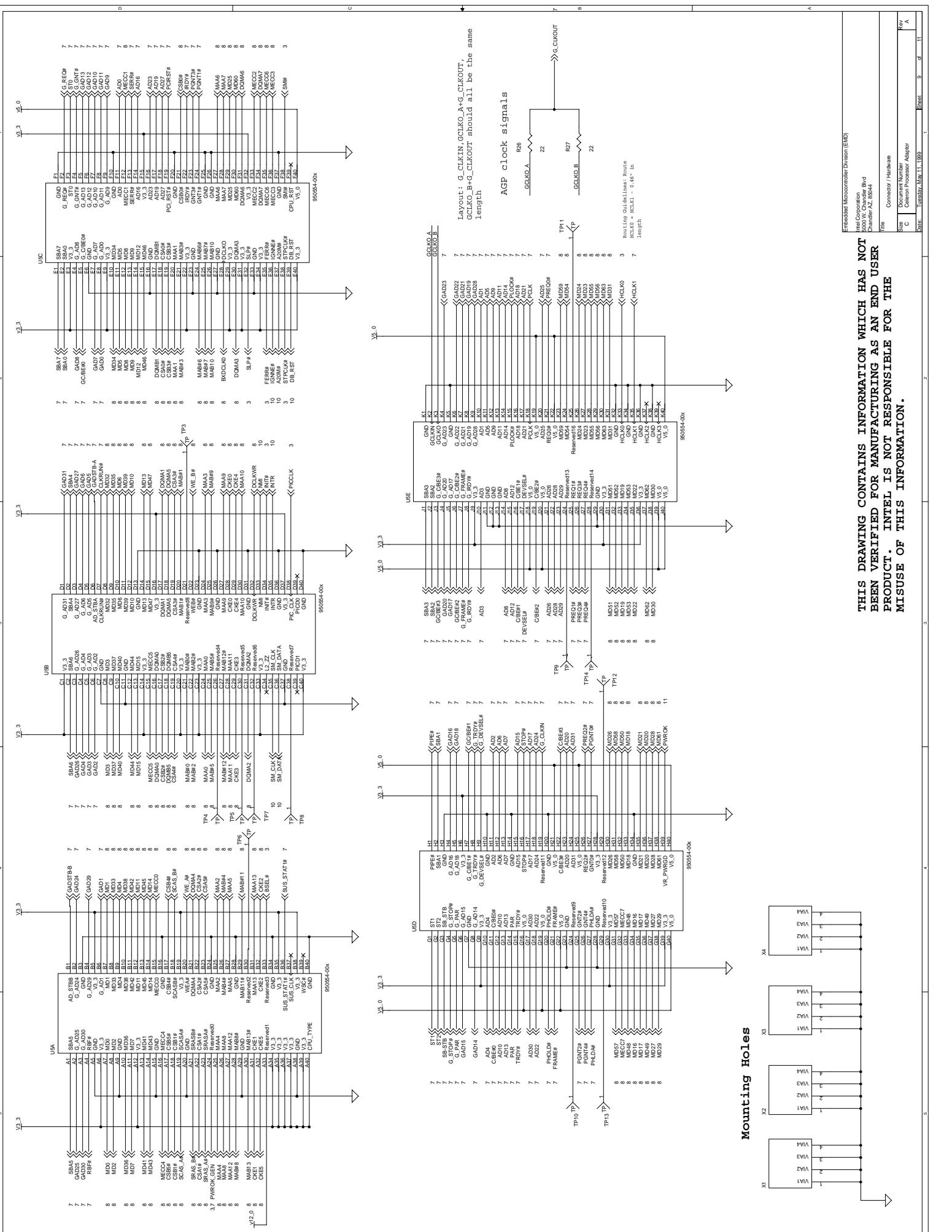

**THIS DRAWING CONTAINS INFORMATION WHICH HAS NOT BEEN VERIFIED FOR MANUFACTURING AS AN END USER PRODUCT. INTEL IS NOT RESPONSIBLE FOR THE MISUSE OF THIS INFORMATION.**

Freescale Microcontroller Division (EMD)	
Intel Corporation	
8000 W. Chandler Blvd	
Chandler, AZ, 85041	
File	Connector / Header
Doc	Doc Number
Rev	Rev
Date	Date

**Mounting Holes**

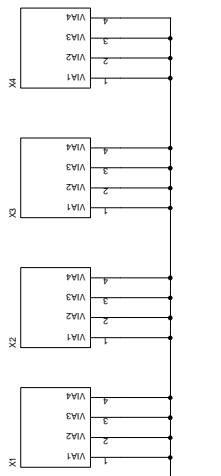





GTU Reference Voltage Generator

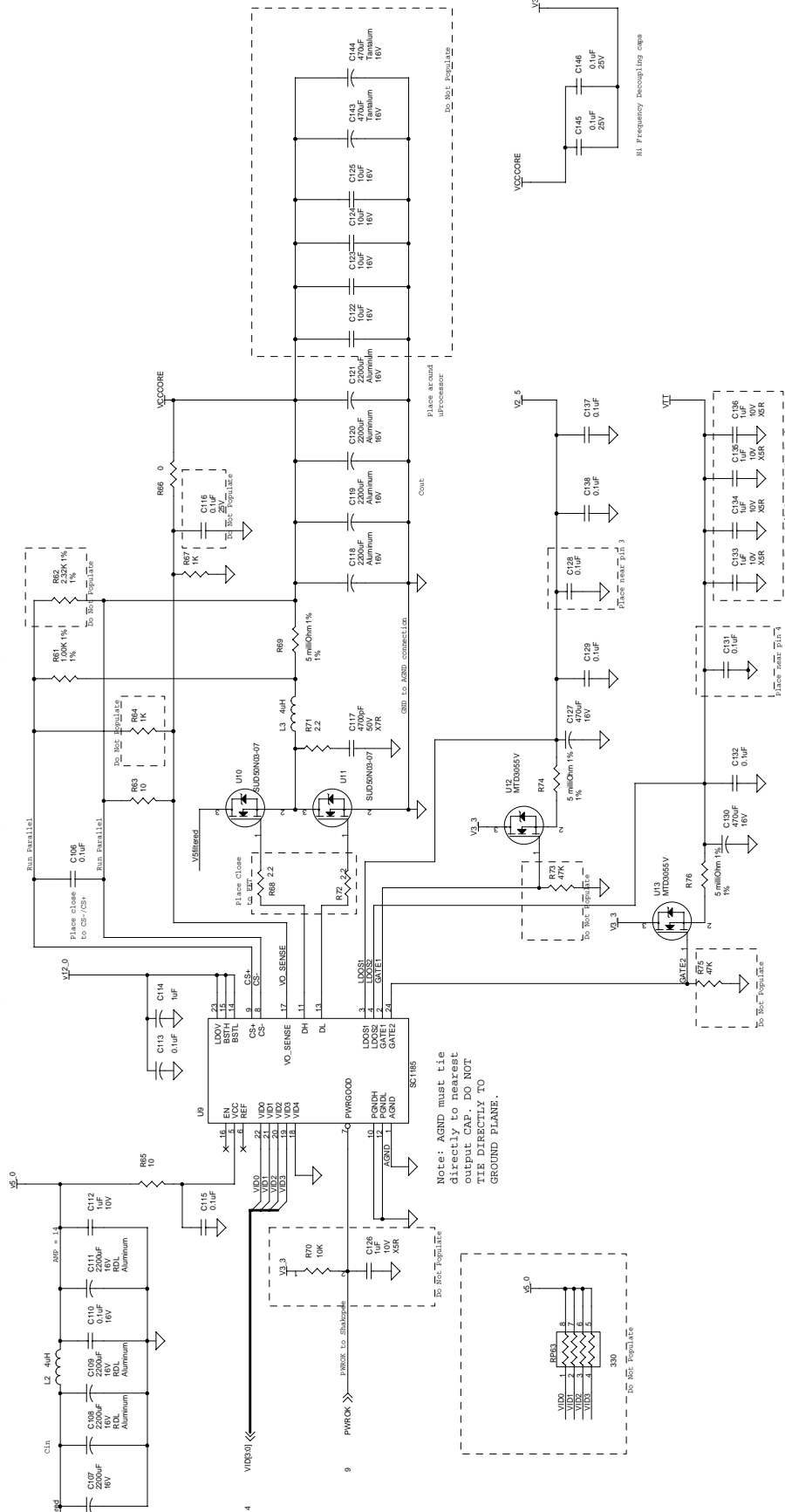
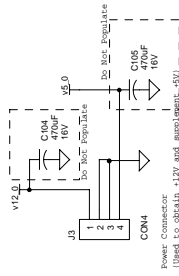
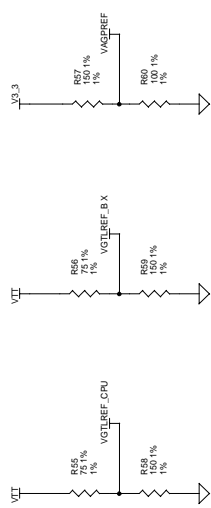

Note: AGND must tie directly to nearest output CAP. DO NOT TIE DIRECTLY TO GROUND PLANE.

**THIS DRAWING CONTAINS INFORMATION WHICH HAS NOT BEEN VERIFIED FOR MANUFACTURING AS AN END USER PRODUCT. INTEL IS NOT RESPONSIBLE FOR THE MISUSE OF THIS INFORMATION.**

Freescale Microcontroller Division (EMD)  
 Intel Corporation  
 3000 W. Chandler Blvd  
 Chandler, AZ, 85044

File: Voltage\_Regulator  
 Document Number: 300001  
 Original File Name: 300001\_Voltage\_Regulator

Rev: 4  
 Sheet: 11 of 11

#, defined 1-1  
 440BX AGPset 3-2  
 82371EB PCI ISA IDE Xcelerator (PIIX4E) 2-1, 3-4  
 82443BX Host Bridge/Controller 2-1

## A

Address size 3-3  
 AGP connector 3-5, 4-10  
 AGP support 2-1, 3-2, 3-3  
 ATX power connector 4-3

## B

Baseboard 2-1  
 Beep codes 5-1, 5-15  
 BIOS 2-7  
   Basic Setup Screen 5-3  
   configuring 2-7  
   Configuring floppy drives 5-4  
   Configuring IDE drives 5-5  
   console redirection 5-9  
   Custom Setup Screen 5-6  
   Drive assignments 5-4  
   Integrated BIOS debugger 5-10  
   Setup Screen System 5-2  
   Shadow Configuration Setup Screen 5-7  
   Standard Diagnostics Routines Setup Screen 5-8  
 BIOS updates 4-13  
 Block diagram 3-1  
 Boot ROM 3-4

## C

CD-ROM drive 2-4  
 Celeron™ Processor 2-1  
 Clock synthesizer 3-6  
 Clocking 3-3  
 Connectors  
   J1, keyboard and mouse 4-5  
   J11, power connector 4-3  
   J13, AGP connector 4-10  
   J2, ITP connector 4-4  
   J2, USB connector 4-4  
   J3, parallel port 4-5  
   J4, serial ports 4-6  
   JP1, floppy connector 4-7  
   JP4/JP3, IDE connector 4-6

## D

DIMM  
   installing 2-7  
 Documents online 1-2  
 DRAM 3-4  
 Drive assignments 5-4

## E

Embedded BIOS 2-3, 5-1  
 Embedded BIOS Integrated Debugger 5-8  
 Embedded BIOS Manufacturing Mode 5-9  
 Evaluation board 2-1  
 Expansion slots 4-2

## F

Floppy connector 4-7  
 Floppy drive 2-4, 3-5  
   installing 2-7

## G

General Software, Inc. 2-3

## H

Hard disk  
   installing 2-6

## I

I/O, legacy support 3-4  
 IDE connectors (JP3, JP4) 4-6  
 IDE interface 3-5  
 Installation 2-5  
 Instructions, notational conventions 1-1  
 Intel® Celeron™ Processor 2-1  
 ISA connectors 3-5  
 ITP Debugger connector 4-4  
 ITP debugger port 3-3

## J

Jumpers  
   default settings 4-11  
   J14, enable spread spectrum clocking 4-11

- J15, clock frequency selection 4-11
- J20, on/off 4-11
- J21, flash BIOS VPP select 4-12
- J22, flash BIOS boot block control 4-12
- J23, SMI# source control 4-12
- J24, CMOS RAM clear 4-12

## **K**

- Keyboard 2-4, 3-5, 4-5
- Kit contents 2-2

## **M**

- Measurements, defined 1-2
- Memory address space 3-3
- Memory interface 2-1
- Memory Map 3-7
- Mouse 2-4, 3-5, 4-5

## **N**

- Notational conventions 1-1
- NVRAM 3-4

## **O**

- Online help 1-2

## **P**

- Parallel port 3-5, 4-5
- PCI connectors 3-5
- PLD A-1
- Post Code Debugger 3-6, 4-1
- POST codes 5-1, 5-12
- Power connector 4-3
- Power LEDs 2-7
- Power supply 2-4, 3-4
  - connecting 2-7
- Power-on Self Test (POST) 5-1
- Processor assembly 2-1
- Product literature, ordering 1-3

## **Q**

- QNX Real-Time Operating System 2-6
- QNX Software Systems, Ltd. 2-4

## **R**

- RTC 3-4

## **S**

- Serial ports 3-5, 4-6
- Setup instructions 2-5
- Signals, notational conventions 1-2
- Software Key Features 2-3

## **T**

- Technical support 1-2

## **U**

- Units of measure, defined 1-2
- USB connector 4-4
- USB support 3-5

## **V**

- Video Adapter 2-4

## **W**

- Windows CE 5-10
- World Wide Web 1-2
- [www.intel.com](http://www.intel.com) 1-2