

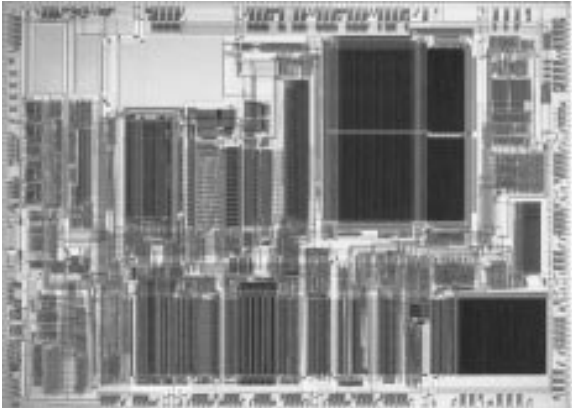

SPECIAL ENVIRONMENT 80960CF-30, -25, -16 32-BIT HIGH-PERFORMANCE SUPERSCALAR PROCESSOR

- Socket and Object Code Compatible with 80960CA
 - Two Instructions/Clock Sustained Execution
 - Four 59 Mbytes/s DMA Channels with Data Chaining
 - Demultiplexed 32-bit Burst Bus with Pipelining
-
- 32-bit Parallel Architecture
 - Two Instructions/clock Execution
 - Load/Store Architecture
 - Sixteen 32-bit Global Registers
 - Sixteen 32-bit Local Registers
 - Manipulate 64-bit Bit Fields
 - 11 Addressing Modes
 - Full Parallel Fault Model
 - Supervisor Protection Model
 - Fast Procedure Call/Return Model
 - Full Procedure Call in 4 clocks
 - On-Chip Register Cache
 - Caches Registers on Call/Ret
 - Minimum of 6 Frames provided
 - Up to 15 Programmable Frames
 - On-Chip Instruction Cache
 - 4 Kbyte Two-Way Set Associative
 - 128-bit Path to Instruction Sequencer
 - Cache-Lock Modes
 - Cache-Off Mode
 - On-Chip Data Cache
 - 1 Kbyte Direct-Mapped, Write Through
 - 128 bits per Clock Access on Cache Hit
 - Product Grades Available
 - SE3: -40°C to +110°C
 - High Bandwidth On-Chip Data RAM
 - 1 Kbytes On-Chip RAM for Data
 - Sustain 128 bits per clock access
 - Four On-Chip DMA Channels
 - 59 Mbytes/s Fly-by Transfers
 - 32 Mbytes/s Two-Cycle Transfers
 - Data Chaining
 - Data Packing/Unpacking
 - Programmable Priority Method
 - 32-Bit Demultiplexed Burst Bus
 - 128-bit Internal Data Paths to *and* from Registers
 - Burst Bus for DRAM Interfacing
 - Address Pipelining Option
 - Fully Programmable Wait States
 - Supports 8, 16 or 32-bit Bus Widths
 - Supports Unaligned Accesses
 - Supervisor Protection Pin
 - Selectable Big or Little Endian Byte Ordering
 - High-Speed Interrupt Controller
 - Up to 248 External Interrupts
 - 32 Fully Programmable Priorities
 - Multi-mode 8-bit Interrupt Port
 - Four Internal DMA Interrupts
 - Separate, Non-maskable Interrupt Pin
 - Context Switch in 750 ns Typical
-



271328-1

Figure 1. 80960CF Die Photo



Special Environment 80960CF-30, -25, -16 32-Bit High Performance Superscalar Processor

CONTENTS	PAGE	CONTENTS	PAGE
1.0 PURPOSE	5	FIGURES	
2.0 i960 CF PROCESSOR OVERVIEW	5	Figure 1 80960CF Die Photo	2
2.1 The C-Series Core	6	Figure 2 80960CF Block Diagram	5
2.2 Pipelined, Burst Bus	6	Figure 3 Example Pin Description Entry	8
2.3 Flexible DMA Controller	6	Figure 4a 80960CF PGA Pinout (View from Top Side)	16
2.4 Priority Interrupt Controller	6	Figure 4b 80960CF PGA Pinout (View from Bottom Side)	17
2.5 Instruction Set Summary	7	Figure 5 168-Lead Ceramic PGA Package Dimensions	18
3.0 PACKAGE INFORMATION	8	Figure 6 80960CF PGA Package Thermal Characteristics	20
3.1 Package Introduction	8	Figure 7 Measuring 80960CF PGA Case Temperature	21
3.2 Pin Descriptions	8	Figure 8 Register G0	21
3.3 80960CF Pinout	14	Figure 9 AC Test Load	30
3.4 Mechanical Data	18	Figure 10a Input and Output Clocks Waveform	30
3.5 Package Thermal Specifications	20	Figure 10b CLKIN Waveform	30
3.6 Stepping Register Information	21	Figure 11 Output Delay and Float Waveform	31
3.7 Suggested Sources for 80960CF Accessories	21	Figure 12a Input Setup and Hold Waveform	31
4.0 ELECTRICAL SPECIFICATIONS	22	Figure 12b $\overline{\text{NMI}}$, $\overline{\text{XINT7:0}}$ Input Setup and Hold Waveform	31
4.1 Absolute Maximum Ratings	22	Figure 13 Hold Acknowledge Timings	32
4.2 Operating Conditions	22	Figure 14 Bus Back-Off (BOFF) Timings	32
4.3 Recommended Connections	22		
4.4 DC Specifications	23		
4.5 AC Specifications	24		
5.0 RESET, BACKOFF AND HOLD ACKNOWLEDGE	35		
6.0 BUS WAVEFORMS	36		



CONTENTS	PAGE
Figure 15 Relative Timings Waveforms	33
Figure 16 Output Delay or Hold vs Load Capacitance	33
Figure 17 Rise and Fall Time Derating at Highest Operating Temperature and Minimum V _{CC}	34
Figure 18 I _{CC} vs Frequency and Temperature	34
Figure 19 Cold Reset Waveform	36
Figure 20 Warm Reset Waveform	37
Figure 21 Entering the ONCE State	38
Figure 22a Clock Synchronization in the 2x Clock Mode	39
Figure 22b Clock Synchronization in the 1x Clock Mode	39
Figure 23 Non-Burst, Non-Pipelined Requests without Wait States	40
Figure 24 Non-Burst, Non-Pipelined Read Request with Wait States	41
Figure 25 Non-Burst, Non-Pipelined Write Request with Wait States	42
Figure 26 Burst, Non-Pipelined Read Request without Wait States, 32-Bit Bus	43
Figure 27 Burst, Non-Pipelined Read Request with Wait States, 32-Bit Bus	44
Figure 28 Burst, Non-Pipelined Write Request without Wait States, 32-Bit Bus	45
Figure 29 Burst, Non-Pipelined Write Request with Wait States, 32-Bit Bus	46
Figure 30 Burst, Non-Pipelined Read Request with Wait States, 16-Bit Bus	47

CONTENTS	PAGE
Figure 31 Burst, Non-Pipelined Read Request with Wait States, 8-Bit Bus	48
Figure 32 Non-Burst, Pipelined Read Request without Wait States, 32-Bit Bus	49
Figure 33 Non-Burst, Pipelined Read Request with Wait States, 32-Bit Bus	50
Figure 34 Burst, Pipelined Read Request without Wait States, 32-Bit Bus	51
Figure 35 Burst, Pipelined Read Requests with Wait States, 32-Bit Bus	52
Figure 36 Burst, Pipelined Read Requests with Wait States, 16-Bit Bus	53
Figure 37 Burst, Pipelined Read Requests with Wait States, 8-Bit Bus	54
Figure 38 Using External $\overline{\text{READY}}$	55
Figure 39 Terminating a Burst with $\overline{\text{BTERM}}$	56
Figure 40 $\overline{\text{BOFF}}$ Functional Timing	57
Figure 41 $\overline{\text{HOLD}}$ Functional Timing	57
Figure 42 $\overline{\text{DREQ}}$ and $\overline{\text{DACK}}$ Functional Timing	58
Figure 43 $\overline{\text{EOP}}$ Functional Timing	58
Figure 44 Terminal Count Functional Timing	59
Figure 45 $\overline{\text{FAIL}}$ Functional Timing	59
Figure 46 A Summary of Aligned and Unaligned Transfers for Little Endian Regions	60
Figure 47 A Summary of Aligned and Unaligned Transfers for Little Endian Regions (Continued)	61
Figure 48 Idle Bus Operation	62





1.0 PURPOSE

This document previews electrical characterizations of Intel's i960 CF embedded microprocessor (available in 33, 25 and 16 MHz). For a detailed description of any i960 CF processor functional topic—other than parametric performance—refer to the latest i960 CA Microprocessor Reference Manual (Order No. 270710) and the *i960 CF Reference Manual Addendum* (Order No. 272188).

2.0 i960 CF PROCESSOR OVERVIEW

Intel's i960 CF microprocessor is the performance follow-on product to the i960 CA processor. The i960 CF product is socket- and object code-compatible with the CA; this makes CA-to-CF design upgrades straightforward. The i960 CF processor's instruction cache is 4 Kbytes (CA device has 1 Kbyte); CF data cache is 1 Kbyte (CA device has no data cache). This extra cache on the CF product adds a significant performance boost over the CA. The 80960CF is object code compatible with the 32-bit 80960 Core Architecture while including Special Function Register extensions to control on-chip peripherals, and instruction set extensions to shift 64-bit operands and configure on-chip hardware. Multiple 128-bit internal busses, on-chip instruction caching and a sophisticated instruction scheduler allow the processor to sustain execution of two instruc-

tions every clock, and peak at execution of three instructions per clock.

A 32-bit demultiplexed and pipelined burst bus provides a 132 Mbyte/s bandwidth to a system's high-speed external memory sub-system. In addition, the 80960CF's on-chip caching of instructions, procedure context and critical program data substantially decouples system performance from the wait states associated with accesses to the system's slower, cost sensitive, main memory sub-system.

The 80960CF bus controller also integrates full wait state and bus width control for highest system performance with minimal system design complexity. Unaligned access and Big Endian byte order support reduces the cost of porting existing applications to the 80960CF.

The processor also integrates four complete data-chaining DMA channels and a high-speed interrupt controller on-chip. The DMA channels perform: single-cycle or two-cycle transfers, data packing and unpacking, and data chaining. Block transfers, in addition to source or destination synchronized transfers, are provided.

The interrupt controller provides full programmability of 248 interrupt sources into 32 priority levels with a typical interrupt task switch ("latency") time of 750 ns.

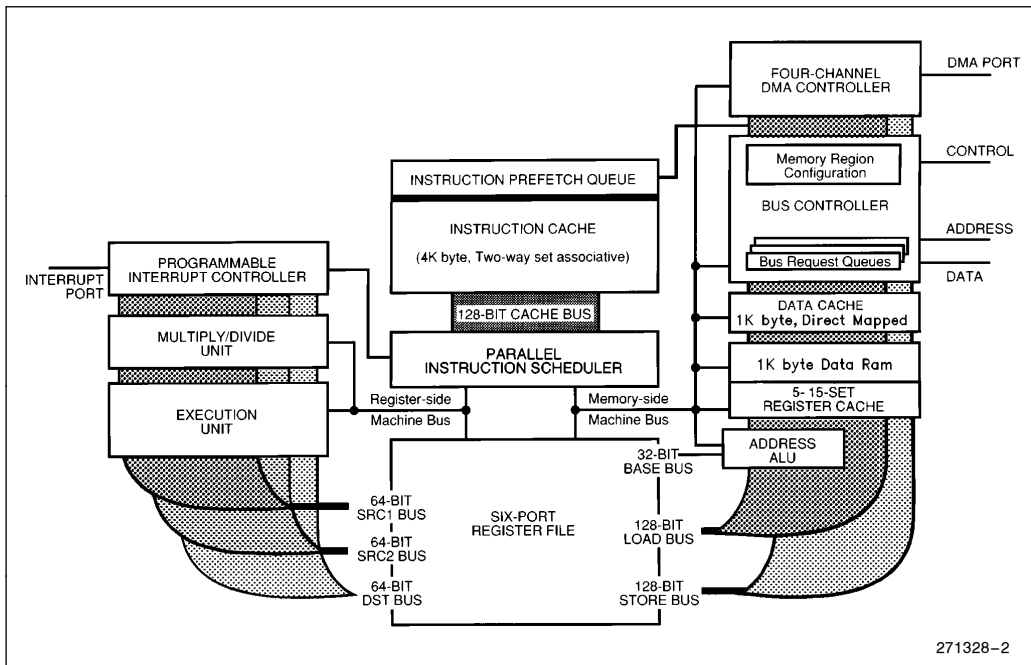

Figure 2. 80960CF Block Diagram



2.1. The C-Series Core

The C-Series core is a very high performance micro-architectural implementation of the 80960 Core Architecture. The C-Series core can sustain execution of two instructions per clock (66 MIPs at 33 MHz). To achieve this level of performance, Intel has incorporated state-of-the-art silicon technology and innovative microarchitectural constructs into the implementation of the C-Series core. Factors that contribute to the core's performance include:

- Parallel instruction decoding allows issue of up to three instructions per clock.
- Most instructions execute in a single clock.
- Parallel instruction decode allows sustained, simultaneous execution of two single-clock instructions every clock cycle.
- Efficient instruction pipeline minimizes pipeline break losses.
- Register and resource scoreboarding allow simultaneous multi-clock instruction execution.
- Branch look-ahead and prediction allows many branches to execute with no pipeline break.
- Local Register Cache integrated on-chip caches Call/Return context.
- Two-way set associative, 4 Kbyte integrated instruction cache.
- Direct mapped, 1 Kbyte data cache, write through, write allocate.
- 1 Kbyte integrated Data RAM sustains a four-word (128-bit) access every clock cycle.

2.2. Pipelined, Burst Bus

A 32-bit high performance bus controller interfaces the 80960CF to external memory and peripherals. The Bus Control Unit features a maximum transfer rate of 132 Mbytes per second (at 33 MHz). Internally programmable wait states and 16 separately configurable memory regions allow the processor to interface with a variety of memory subsystems with a minimum of system complexity and a maximum of performance. The Bus Controller's main features include:

- Demultiplexed, Burst Bus to exploit most efficient DRAM access modes.
- Address Pipelining to reduce memory cost while maintaining performance.
- 32-, 16- and 8-bit modes for I/O interfacing ease.
- Full internal wait state generation to reduce system cost.
- Little and Big Endian support to ease application development.
- Unaligned access support for code portability.
- Three-deep request queue to decouple the bus from the core.

2.3. Flexible DMA Controller

A four channel DMA controller provides high speed DMA control for data transfers involving peripherals and memory. The DMA provides advanced features such as data chaining, byte assembly and disassembly, and a high performance fly-by mode capable of transfer speed of up to 59 Mbytes per second at 33 MHz. The DMA controller features a performance and flexibility which is only possible by integrating the DMA controller and the 80960CF core.

2.4. Priority Interrupt Controller

A programmable-priority interrupt controller manages up to 248 external sources through the 8-bit external interrupt port. The Interrupt Unit also handles the four internal sources from the DMA controller, and a single non-maskable interrupt input. The 8-bit interrupt port can also be configured to provide individual interrupt sources that are level or edge triggered.

Interrupts in the 80960CF are prioritized and signaled within 270 ns of the request. If the interrupt is of higher priority than the processor priority, the context switch to the interrupt routine typically is complete in another 480 ns. The interrupt unit provides the mechanism for the low latency and high throughput interrupt service which is essential for embedded applications.

2.5. Instruction Set Summary

The following table summarizes the 80960CF instruction set by logical groupings. See the *i960 CA Microprocessor Reference Manual* for a complete description of the instruction set.

Data Movement	Arithmetic	Logical	Bit, Bit Field and Byte
Load Store Move Load Address	Add Subtract Multiply Divide Remainder Modulo Shift *Extended Shift Extended Multiply Extended Divide Add with Carry Subtract with Carry Rotate	And Not And And Not Or Exclusive Or Not Or Or Not Nor Exclusive Nor Not Nand	Set Bit Clear Bit Not Bit Alter Bit Scan for Bit Span over Bit Extract Modify Scan Byte for Equal
Comparison	Branch	Call and Return	Fault
Compare Conditional Compare Compare and Increment Compare and Decrement Test Condition Code Check Bit	Unconditional Branch Conditional Branch Compare and Branch	Call Call Extended Call System Return Branch and Link	Conditional Fault Synchronize Faults
Debug	Processor Management	Atomic	
Modify Trace Controls Mark Force Mark	Modify Process Controls Modify Arithmetic Controls *System Control *DMA Control Flush Local Registers	Atomic Add Atomic Modify	

NOTE:
Instructions marked by (*) are 80960CF extensions to the 80960 instruction set.

3.0 PACKAGE INFORMATION

3.1. Package Introduction

This section describes the pins, pinouts and thermal characteristics for the 80960CF in the 168-pin Ceramic Pin Grid Array (PGA) package. For complete package specifications and information, see the Intel *Packaging Outlines and Dimensions Guide* (Order No. 231369).

3.2. Pin Descriptions

The 80960CF pins are described in this section. Table 1 presents the legend for interpreting the pin descriptions in the following tables.

Pins associated with the 32-bit demultiplexed processor bus are described in Table 2. Pins associated with basic processor configuration and control are described in Table 3. Pins associated with the 80960CF DMA Controller and Interrupt Unit are described in Table 4.

Figure 3 provides an example pin description table entry. "I/O" signifies that data pins are input-output. "S" indicates pins are synchronous to PCLK2:1. "H(Z)" indicates that these pins float while the processor bus is in a Hold Acknowledge state. "R(Z)" indicates that the pins also float while $\overline{\text{RESET}}$ is low.

All pins float while the processor is in the ONCE mode.

Table 1. Pin Description Nomenclature

Symbol	Description
I	Input only pin
O	Output only pin
I/O	Pin can be either an input or output
-	Pins "must be" connected as described
S(. . .)	Synchronous. Inputs must meet setup and hold times relative to PCLK2:1 for proper operation. All outputs are synchronous to PCLK2:1. S(E) Edge sensitive input S(L) Level sensitive input
A(. . .)	Asynchronous. Inputs may be asynchronous to PCLK2:1. A(E) Edge sensitive input A(L) Level sensitive input
H(. . .)	While the processor's bus is in the Hold Acknowledge or Bus Backoff state, the pin: H(1) is driven to V_{CC} H(0) is driven to V_{SS} H(Z) floats H(Q) continues to be a valid output
R(. . .)	While the processor's $\overline{\text{RESET}}$ pin is low, the pin R(1) is driven to V_{CC} R(0) is driven to V_{SS} R(Z) floats R(Q) continues to be a valid output

Name	Type	Description
D31:0	I/O S(L) H(Z) R(Z)	DATA BUS carries 32-, 16- or 8-bit data quantities depending on bus width configuration. The least significant bit of the data is carried on D0 and the most significant on D31. When the bus is configured for 8-bit data, the lower 8 data lines, D7:0 are used. For 16-bit bus widths, D15:0 are used. For 32-bit bus widths the full data bus is used.

Figure 3. Example Pin Description Entry

Table 2. 80960CF Pin Description—External Bus Signals

Name	Type	Description																																				
A31:2	O S H(Z) R(Z)	ADDRESS BUS carries the physical address upper 30 bits. A31 is the most significant address bit and A2 is the least significant. During a bus access, A31:2 identify all external addresses to word (4-byte) boundaries. The byte enable signals indicate the selected byte in each word. During burst accesses, A3 and A2 increment to indicate successive data cycles.																																				
D31:0	I / O S(L) H(Z) R(Z)	DATA BUS carries 32-, 16- or 8-bit data quantities depending on bus width configuration. The least significant bit of the data is carried on D0 and the most significant on D31. When the bus is configured for 8-bit data, the lower 8 data lines, D7:0 are used. For 16-bit bus widths, D15:0 are used. For 32-bit bus widths the full data bus is used.																																				
$\overline{BE3}$ $\overline{BE2}$ $\overline{BE1}$ $\overline{BE0}$	O S H(Z) R(1)	<p>BYTE ENABLES select which of the four bytes addressed by A31:2 are active during an access to a memory region configured for a 32-bit data-bus width. $\overline{BE3}$ applies to D31:24; $\overline{BE2}$ applies to D23:16; $\overline{BE1}$ applies to D15:8; and $\overline{BE0}$ applies to D7:0.</p> <p>32-bit bus:</p> <table> <tr> <td>$\overline{BE3}$</td> <td>–Byte Enable 3</td> <td>–enable D31:24</td> </tr> <tr> <td>$\overline{BE2}$</td> <td>–Byte Enable 2</td> <td>–enable D23:16</td> </tr> <tr> <td>$\overline{BE1}$</td> <td>–Byte Enable 1</td> <td>–enable D15:8</td> </tr> <tr> <td>$\overline{BE0}$</td> <td>–Byte Enable 0</td> <td>–enable D7:0</td> </tr> </table> <p>For accesses to a memory region configured for a 16-bit data-bus width, the processor directly encodes $\overline{BE3}$, $\overline{BE1}$ and $\overline{BE0}$ to provide \overline{BHE}, A1 and \overline{BLE} respectively.</p> <p>16-bit bus:</p> <table> <tr> <td>$\overline{BE3}$</td> <td>–Byte High Enable (\overline{BHE})</td> <td>–enable D15:8</td> </tr> <tr> <td>$\overline{BE2}$</td> <td>–Not used (is driven high or low)</td> <td></td> </tr> <tr> <td>$\overline{BE1}$</td> <td>–Address Bit 1 (A1)</td> <td></td> </tr> <tr> <td>$\overline{BE0}$</td> <td>–Byte Low Enable (\overline{BLE})</td> <td>–enable D7:0</td> </tr> </table> <p>For accesses to a memory region configured for an 8-bit data bus width, the processor directly encodes $\overline{BE1}$ and $\overline{BE0}$ to provide A1 and A0 respectively.</p> <p>8-bit bus:</p> <table> <tr> <td>$\overline{BE3}$</td> <td>–Not used (is driven high or low)</td> <td></td> </tr> <tr> <td>$\overline{BE2}$</td> <td>–Not used (is driven high or low)</td> <td></td> </tr> <tr> <td>$\overline{BE1}$</td> <td>–Address Bit 1 (A1)</td> <td></td> </tr> <tr> <td>$\overline{BE0}$</td> <td>–Address Bit 0 (A0)</td> <td></td> </tr> </table>	$\overline{BE3}$	–Byte Enable 3	–enable D31:24	$\overline{BE2}$	–Byte Enable 2	–enable D23:16	$\overline{BE1}$	–Byte Enable 1	–enable D15:8	$\overline{BE0}$	–Byte Enable 0	–enable D7:0	$\overline{BE3}$	–Byte High Enable (\overline{BHE})	–enable D15:8	$\overline{BE2}$	–Not used (is driven high or low)		$\overline{BE1}$	–Address Bit 1 (A1)		$\overline{BE0}$	–Byte Low Enable (\overline{BLE})	–enable D7:0	$\overline{BE3}$	–Not used (is driven high or low)		$\overline{BE2}$	–Not used (is driven high or low)		$\overline{BE1}$	–Address Bit 1 (A1)		$\overline{BE0}$	–Address Bit 0 (A0)	
$\overline{BE3}$	–Byte Enable 3	–enable D31:24																																				
$\overline{BE2}$	–Byte Enable 2	–enable D23:16																																				
$\overline{BE1}$	–Byte Enable 1	–enable D15:8																																				
$\overline{BE0}$	–Byte Enable 0	–enable D7:0																																				
$\overline{BE3}$	–Byte High Enable (\overline{BHE})	–enable D15:8																																				
$\overline{BE2}$	–Not used (is driven high or low)																																					
$\overline{BE1}$	–Address Bit 1 (A1)																																					
$\overline{BE0}$	–Byte Low Enable (\overline{BLE})	–enable D7:0																																				
$\overline{BE3}$	–Not used (is driven high or low)																																					
$\overline{BE2}$	–Not used (is driven high or low)																																					
$\overline{BE1}$	–Address Bit 1 (A1)																																					
$\overline{BE0}$	–Address Bit 0 (A0)																																					
W/\overline{R}	O S H(Z) R(0)	WRITE/READ is asserted for read requests and deasserted for write requests. The W/ \overline{R} signal changes in the same clock cycle as \overline{ADS} . It remains valid for the entire access in non-pipelined regions. In pipelined regions, W/ \overline{R} is not guaranteed valid in the last cycle of a read access.																																				
\overline{ADS}	O S H(Z) R(1)	ADDRESS STROBE indicates valid address and the start of a new bus access. \overline{ADS} is asserted for the first clock of a bus access.																																				
READY	I S(L) H(Z) R(Z)	READY is an input which signals the termination of a data transfer. \overline{READY} is used to indicate that read data on the bus is valid, or that a write-data transfer has completed. The \overline{READY} signal works in conjunction with the internally programmed wait-state generator. If \overline{READY} is enabled in a region, the pin is sampled after the programmed number of wait-states has expired. If the \overline{READY} pin is deasserted, wait states continue to be inserted until \overline{READY} becomes asserted. This is true for the N_{RAD} , N_{RDD} , N_{WAD} , and N_{WDD} wait states. The N_{XDA} wait states cannot be extended.																																				

Table 2. 80960CF Pin Description—External Bus Signals (Continued)

Name	Type	Description
BTERM	I S(L) H(Z) R(Z)	BURST TERMINATE —The burst terminate signal breaks up a burst access and causes another address cycle to occur. The BTERM signal works in conjunction with the internally programmed wait-state generator. If READY and BTERM are enabled in a region, the BTERM pin is sampled after the programmed number of wait states has expired. When BTERM is asserted, a new ADS signal is generated and the access is completed. The READY input is ignored when BTERM is asserted. BTERM must be externally synchronized to satisfy the BTERM setup and hold times.
WAIT	O S H(Z) R(1)	WAIT indicates internal wait state generator status. WAIT is asserted when wait states are being caused by the internal wait state generator and not by the READY or BTERM inputs. WAIT can be used to derive a write-data strobe. WAIT can also be thought of as a READY output that the processor provides when it is inserting wait states.
BLAST	O S H(Z) R(0)	BURST LAST indicates the last transfer in a bus access. BLAST is asserted in the last data transfer of burst and non-burst accesses after the wait state counter reaches zero. BLAST remains asserted until the clock following the last cycle of the last data transfer of a bus access. If the READY or BTERM input is used to extend wait states, the BLAST signal remains asserted until READY or BTERM terminates the access.
DT/\bar{R}	O S H(Z) R(0)	DATA TRANSMIT/RECEIVE indicates direction for data transceivers. DT/ \bar{R} is used in conjunction with DEN to provide control for data transceivers attached to the external bus. When DT/ \bar{R} is asserted, the signal indicates that the processor receives data. Conversely, when deasserted, the processor sends data. DT/ \bar{R} changes only while DEN is high.
DEN	O S H(Z) R(1)	DATA ENABLE indicates data cycles in a bus request. DEN is asserted at the start of the bus request first data cycle and is deasserted at the end of the last data cycle. DEN is used in conjunction with DT/ \bar{R} to provide control for data transceivers attached to the external bus. DEN remains asserted for sequential reads from pipelined memory regions. DEN is deasserted when DT/ \bar{R} changes.
LOCK	O S H(Z) R(1)	BUS LOCK indicates that an atomic read-modify-write operation is in progress. LOCK may be used to prevent external agents from accessing memory which is currently involved in an atomic operation. LOCK is asserted in the first clock of an atomic operation, and deasserted in the clock cycle following the last bus access for the atomic operation. To allow the most flexibility for a memory system enforcement of locked accesses, the processor acknowledges a bus hold request when LOCK is asserted. The processor performs DMA transfers while LOCK is active.
HOLD	I S(L) H(Z) R(Z)	HOLD REQUEST signals that an external agent requests access to the external bus. The processor asserts HOLDA after completing the current bus request. HOLD, HOLDA and BREQ are used together to arbitrate access to the processor's external bus by external bus agents.
BOFF	I S(L) H(Z) R(Z)	BUS BACKOFF —The backoff pin, when asserted, suspends the current access and causes the bus pins to float. When deasserted, the ADS signal is asserted on the next clock cycle and the access is resumed.

Table 2. 80960CF Pin Description—External Bus Signals (Continued)

Name	Type	Description
HOLDA	O S H(1) R(Q)	HOLD ACKNOWLEDGE indicates to a bus requestor that the processor has relinquished control of the external bus. When HOLDA is asserted, the external address bus, data bus and bus control signals are floated. HOLD, $\overline{\text{BOFF}}$, HOLDA and BREQ are used together to arbitrate access to the processor's external bus by external bus agents. Since the processor grants HOLD requests and enters the Hold Acknowledge state even while $\overline{\text{RESET}}$ is asserted, HOLDA pin state is independent of the RESET pin.
BREQ	O S H(Q) R(O)	BUS REQUEST is asserted when the bus controller has a request pending. BREQ can be used by external bus arbitration logic in conjunction with HOLD and HOLDA to determine when to return mastership of the external bus to the processor.
D/$\overline{\text{C}}$	O S H(Z) R(Z)	DATA OR CODE is asserted for a data request and deasserted for instruction requests. D/ $\overline{\text{C}}$ has the same timing as W/ $\overline{\text{R}}$.
$\overline{\text{DMA}}$	O S H(Z) R(Z)	DMA ACCESS indicates whether the bus request was initiated by the DMA controller. $\overline{\text{DMA}}$ is asserted for any DMA request. $\overline{\text{DMA}}$ is deasserted for all other requests.
$\overline{\text{SUP}}$	O S H(Z) R(Z)	SUPERVISOR ACCESS indicates whether the bus request is issued while in supervisor mode. $\overline{\text{SUP}}$ is asserted when the request has supervisor privileges, and is deasserted otherwise. $\overline{\text{SUP}}$ can be used to isolate supervisor code and data structures from non-supervisor requests.

Table 3. 80960CF Pin Description—Processor Control Signals

Name	Type	Description
$\overline{\text{RESET}}$	I A(L) H(Z) R(Z) N(Z)	RESET causes the chip to reset. When $\overline{\text{RESET}}$ is asserted, all external signals return to the reset state. When $\overline{\text{RESET}}$ is deasserted, initialization begins. When the 2-x clock mode is selected, $\overline{\text{RESET}}$ must remain asserted for 16 PCLK2:1 cycles before being deasserted in order to guarantee correct processor initialization. When the 1-x clock mode is selected, $\overline{\text{RESET}}$ must remain asserted for 10,000 PCLK2:1 cycles before being deasserted in order to guarantee correct initialization. The CLKMODE pin selects 1-x or 2-x input clock division of the CLKIN pin. The processor's Hold Acknowledge bus state functions while the chip is reset. If the processor's bus is in the Hold Acknowledge state when $\overline{\text{RESET}}$ is asserted, the processor will internally reset, but maintains the Hold Acknowledge state on external pins until the Hold request is removed. If a hold request is made while the processor is in the reset state, the processor bus grants HOLDA and enters the Hold Acknowledge state.
$\overline{\text{FAIL}}$	O S H(Q) R(O)	FAIL indicates failure of the processor's self-test performed at initialization. When $\overline{\text{RESET}}$ is deasserted and the processor begins initialization, the $\overline{\text{FAIL}}$ pin is asserted. An internal self-test is performed as part of the initialization process. If this self-test passes, the $\overline{\text{FAIL}}$ pin is deasserted otherwise it remains asserted. The $\overline{\text{FAIL}}$ pin is reasserted while the processor performs an external bus self-confidence test. If this self-test passes, the processor deasserts the $\overline{\text{FAIL}}$ pin and branches to the user's initialization routine; otherwise the $\overline{\text{FAIL}}$ pin remains asserted. Internal self-test and the use of the $\overline{\text{FAIL}}$ pin can be disabled with the STEST pin.

Table 3. 80960CF Pin Description—Processor Control Signals (Continued)

Name	Type	Description
STEST	I S(L) H(Z) R(Z)	SELF TEST causes the processor's internal self-test feature to be enabled or disabled at initialization. STEST is read on the rising edge of $\overline{\text{RESET}}$. When asserted, the processor's internal self-test and external bus confidence tests are performed during processor initialization. When deasserted, only the external bus confidence tests are performed during initialization.
$\overline{\text{ONCE}}$	I A(L) H(Z) R(Z)	<p>ON CIRCUIT EMULATION causes all outputs to be floated when asserted. $\overline{\text{ONCE}}$ is continuously sampled while $\overline{\text{RESET}}$ is low, and is latched on the rising edge of $\overline{\text{RESET}}$. To place the processor in the ONCE state:</p> <ol style="list-style-type: none"> (1) assert $\overline{\text{RESET}}$ and $\overline{\text{ONCE}}$ (order does not matter) (2) wait for at least 16 CLKIN periods in 2-x mode, or 10,000 CLKIN periods in 1-x mode, after V_{CC} and CLKIN are within operating specifications (3) deassert $\overline{\text{RESET}}$ (4) wait at least 32 CLKIN periods <p>(The processor is now latched in the ONCE state as long as $\overline{\text{RESET}}$ is high.)</p> <p>To exit the ONCE state, bring V_{CC} and CLKIN to operating conditions, then assert $\overline{\text{RESET}}$ and bring ONCE high prior to deasserting $\overline{\text{RESET}}$.</p> <p>CLKIN must operate within the specified operating conditions of the processor until step 4 above is completed. The CLKIN may then be changed to DC to achieve the lowest possible ONCE mode leakage current.</p> <p>$\overline{\text{ONCE}}$ can be used by emulator products or for board testers to effectively make an installed processor transparent in the board.</p>
CLKIN	I A(E) H(Z) R(Z)	CLOCK INPUT is an input for the external clock needed to run the processor. The external clock is internally divided as prescribed by the CLKMODE pin to produce PCLK2:1.
CLKMODE	I A(L) H(Z) R(Z)	CLOCK MODE selects the division factor applied to the external clock input (CLKIN). When CLKMODE is high, CLKIN is divided by one to create PCLK2:1 and the processor's internal clock. When CLKMODE is low, CLKIN is divided by two to create PCLK2:1 and the processor's internal clock. CLKMODE should be tied high or low in a system, as the clock mode is not latched by the processor. If left unconnected, the processor internally pulls the CLKMODE pin low, enabling the 2-x clock mode.
PCLK2 PCLK1	O S H(Q) R(Q)	PROCESSOR OUTPUT CLOCKS provide a timing reference for all inputs and outputs of the processor. All inputs and output timings are specified in relation to PCLK2 and PCLK1. PCLK2 and PCLK1 are identical signals. Two output pins are provided to allow flexibility in the system's allocation of capacitive loading on the clock. PCLK2:1 may also be connected at the processor to form a single clock signal.
V_{SS}	—	GROUND connections consist of 24 pins which must be connected externally to a V _{SS} board plane.
V_{CC}	—	POWER connections consist of 24 pins which must be connected externally to a V _{CC} board plane.
V_{CCPLL}	—	V_{CCPLL} is a separate V _{CC} supply pin for the phase lock loop used in 1x clock mode. Connecting a simple low pass filter to V _{CCPLL} may help reduce clock jitter (T _{CP}) in noisy environments. Otherwise, V _{CCPLL} should be connected to V _{CC} .
N/C	—	NO CONNECT pins must not be connected in a system.

Table 4. 80960CF Pin Description—DMA and Interrupt Unit Control Signals

Name	Type	Description
DREQ3 DREQ2 DREQ1 DREQ0	I A(L) H(Z) R(Z)	DMA REQUEST causes a DMA transfer to be requested. Each of the four signals request a transfer on a single channel. $\overline{\text{DREQ0}}$ requests channel 0, $\overline{\text{DREQ1}}$ requests channel 1, etc. When two or more channels are requested simultaneously, the channel with the highest priority is serviced first. Channel priority mode is programmable.
DACK3 DACK2 DACK1 DACK0	O S H(1) R(1)	DMA ACKNOWLEDGE indicates that a DMA transfer is being executed. Each of the four signals acknowledge a transfer for a single channel. $\overline{\text{DACK0}}$ acknowledges channel 0, $\overline{\text{DACK1}}$ acknowledges channel 1, etc. $\overline{\text{DACK3:0}}$ are asserted when the requesting device of a DMA is accessed.
EOP3/TC3 EOP2/TC2 EOP1/TC1 EOP0/TC0	I / O A(L) H(Z/Q) R(Z)	END OF PROCESS/TERMINAL COUNT can be programmed as either an input ($\overline{\text{EOP3:0}}$) or as an output ($\overline{\text{TC3:0}}$), but not both. Each pin is individually programmable. When programmed as an input, $\overline{\text{EOPx}}$ causes the termination of a current DMA transfer for the channel corresponding to the $\overline{\text{EOPx}}$ pin. $\overline{\text{EOP0}}$ corresponds to channel 0, $\overline{\text{EOP1}}$ corresponds to channel 1, etc. When a channel is configured for source <i>and</i> destination chaining, the EOP pin for that channel causes termination of <i>only</i> the current buffer transferred and causes the next buffer to be transferred. $\overline{\text{EOP3:0}}$ are asynchronous inputs. When programmed as an output, the channel's $\overline{\text{TCx}}$ pin indicates that the channel byte count has reached 0 and a DMA has terminated. $\overline{\text{TCx}}$ is driven with the same timing as $\overline{\text{DACKx}}$ during the last DMA transfer for a buffer. If the last bus request is executed as multiple bus accesses, $\overline{\text{TCx}}$ remains asserted for the entire bus request.
XINT7 XINT6 XINT5 XINT4 XINT3 XINT2 XINT1 XINT0	I A(E/L) H(Z) R(Z)	EXTERNAL INTERRUPT PINS cause interrupts to be requested. These pins can be configured in three modes. In Dedicated Mode, each pin is a dedicated external interrupt source. Dedicated inputs can be individually programmed to be level (low) or edge (falling) activated. In Expanded Mode, the 8 pins act together as an 8-bit vectored interrupt source. The interrupt pins in this mode are level activated. Since the interrupt pins are active low, the vector number requested is the one's complement of the positive logic value place on the port. This eliminates glue logic to interface to combinational priority encoders which output negative logic. In Mixed Mode, $\overline{\text{XINT7:5}}$ are dedicated sources and $\overline{\text{XINT4:0}}$ act as the 5 most significant bits of an expanded mode vector. The least significant bits are set to 010 internally.
NMI	I A(E) H(Z) R(Z)	NON-MASKABLE INTERRUPT causes a non-maskable interrupt event to occur. $\overline{\text{NMI}}$ is the highest priority interrupt recognized. $\overline{\text{NMI}}$ is an edge (falling) activated source.



3.3. 80960CF Pinout

80960CF pinout as viewed from the top side of the component (i.e., pins facing down). Figure 4b shows the complete 80960CF pinout as viewed from the pin-side of the package (i.e., pins facing up). See **Section 4.0, Electrical Specifications** for specifications and recommended connections.

3.3.1 80960CF PGA PINOUT

Tables 5 and 6 list the 80960CF pin names with package location. Figure 4-a depicts the complete

Table 5. PGA Pin Name with Package Location (Signal Order)

Address Bus	Data Bus	Bus Control	Processor Control	I/O	
Name ..Location	Name ..Location	Name ..Location	NameLocation	Name ..Location	
A31S15	D31R03	$\overline{BE3}$S05	\overline{RESET}A16	$\overline{DREQ3}$A07	
A30Q13	D30Q05	$\overline{BE2}$S06		$\overline{DREQ2}$B06	
A29R14	D29S02	$\overline{BE1}$S07	FAILA02	$\overline{DREQ1}$A06	
A28Q14	D28Q04	$\overline{BE0}$R09		$\overline{DREQ0}$B05	
A27S16	D27R02		STESTB02		
A26R15	D26Q03	W/RS10		$\overline{DACK3}$A10	
A25S17	D25S01		\overline{ONCE}C03	$\overline{DACK2}$A09	
A24Q15	D24R01	\overline{ADS}R06		$\overline{DACK1}$A08	
A23R16	D23Q02		CKLINC13	$\overline{DACK0}$B08	
A22R17	D22P03	READYS03	CLKMODE ...C14		
A21Q16	D21Q01	\overline{BTERM}R04	PCLK1B14	$\overline{EOP/TC0}$...A11	
A20P15	D20P02		PCLK2B13	$\overline{EOP/TC1}$...A12	
A19P16	D19P01	\overline{WAIT}S12		$\overline{EOP/TC2}$...A13	
A18Q17	D18N02	\overline{BLAST}S08	V_{SS}	$\overline{EOP/TC3}$...A14	
A17P17	D17N01		<i>Location</i>		
A16N16	D16M01	$\overline{DT/R}$S11	C07, C08, C09, C10, C11, C12, F15, G03, G15, H03, H15, J03, J15, K03, K15, L03, L15, M03, M15, Q07, Q08, Q09, Q10, Q11	$\overline{XINT7}$C17	
A15N17	D15L01	\overline{DEN}S09		$\overline{XINT6}$C16	
A14M17	D14L02			$\overline{XINT5}$B17	
A13L16	D13K01	\overline{LOCK}S14		$\overline{XINT4}$C15	
A12L17	D12J01			$\overline{XINT3}$B16	
A11K17	D11H01	HOLDR05	V_{CC}	$\overline{XINT2}$A17	
A10J17	D10H02	HOLDAS04	<i>Location</i>	$\overline{XINT1}$A15	
A9H17	D9G01	BREQR13		$\overline{XINT0}$B15	
A8G17	D8F01		B07, B09, B11, B12, C06, E15, F03, F16, G02, H16, J02, J16, K02, K16, M02, M16, N03, N15, Q06, R07, R08, R10, R11 V _{CCPLL}B10		
A7G16	D7E01	$\overline{D/C}$S13			\overline{NMI}D15
A6F17	D6F02	\overline{DMA}R12			
A5E17	D5D01	\overline{SUP}Q12			
A4E16	D4E02				
A3D17	D3C01	\overline{BOFF}B01	No Connect		
A2D16	D2D02		<i>Location</i>		
	D1C02		A01, A03, A04, A05, B03, B04, C04, C05, D03		
	D0E03				

Table 6. PGA Pin Name with Package Location (Pin Order)

Address Bus	Data Bus	Bus Control	Processor Control	I/O
<i>Location ..Name</i>	<i>Location ..Name</i>	<i>Location ..Name</i>	<i>LocationName</i>	<i>Location ..Name</i>
A01NC	C01D3	G01D9	M01D16	R01D24
A02FAIL	C02D1	G02V _{CC}	M02V _{CC}	R02D27
A03NC	C03ONCE	G03V _{SS}	M03V _{SS}	R03D31
A04NC	C04NC	G15V _{SS}	M15V _{SS}	R04BTERM
A05NC	C05NC	G16A7	M16V _{CC}	R05HOLD
A06DREQ1	C06V _{CC}	G17A8	M17A14	R06ADS
A07DREQ3	C07V _{SS}			R07V _{CC}
A08DACK1	C08V _{SS}	H01D11	N01D17	R08V _{CC}
A09DACK2	C09V _{SS}	H02D10	N02D18	R09BE0
A10DACK3	C10V _{SS}	H03V _{SS}	N03V _{CC}	R10V _{CC}
A11EOP/TC0	C11V _{SS}	H15V _{SS}	N15V _{CC}	R11V _{CC}
A12EOP/TC1	C12V _{SS}	H16V _{CC}	N16A16	R12DMA
A13EOP/TC2	C13CLKIN	H17A9	N17A15	R13BREQ
A14EOP/TC3	C14CLKMODE			R14A29
A15XINT1	C15XINT4	J01D12	P01D19	R15A26
A16RESET	C16XINT6	J02V _{CC}	P02D20	R16A23
A17XINT2	C17XINT7	J03V _{SS}	P03D22	R17A22
		J15V _{SS}	P15A20	
B01BOFF	D01D5	J16V _{CC}	P16A19	S01D25
B02STEST	D02D2	J17A10	P17A17	S02D29
B03NC	D03NC			S03READY
B04NC	D15NMI	K01D13	Q01D21	S04HOLDA
B05DREQ0	D16A2	K02V _{CC}	Q02D23	S05BE3
B06DREQ2	D17A3	K03V _{SS}	Q03D26	S06BE2
B07V _{CC}		K15V _{SS}	Q04D28	S07BE1
B08DACK0	E01D7	K16V _{CC}	Q05D30	S08BLAST
B09V _{CC}	E02D4	K17A11	Q06V _{CC}	S09DEN
B10V _{CC} PLL	E03D0		Q07V _{SS}	S10W/R
B11V _{CC}	E15V _{CC}	L01D15	Q08V _{SS}	S11DT/R
B12V _{CC}	E16A4	L02D14	Q09V _{SS}	S12WAIT
B13PCLK2	E17A5	L03V _{SS}	Q10V _{SS}	S13D/C
B14PCLK1		L15V _{SS}	Q11V _{SS}	S14LOCK
B15XINT0	F01D8	L16A13	Q12SUP	S15A31
B16XINT3	F02D6	L17A12	Q13A30	S16A27
B17XINT5	F03V _{CC}		Q14A28	S17A25
	F15V _{SS}		Q15A24	
	F16V _{CC}		Q16A21	
	F17A6		Q17A18	

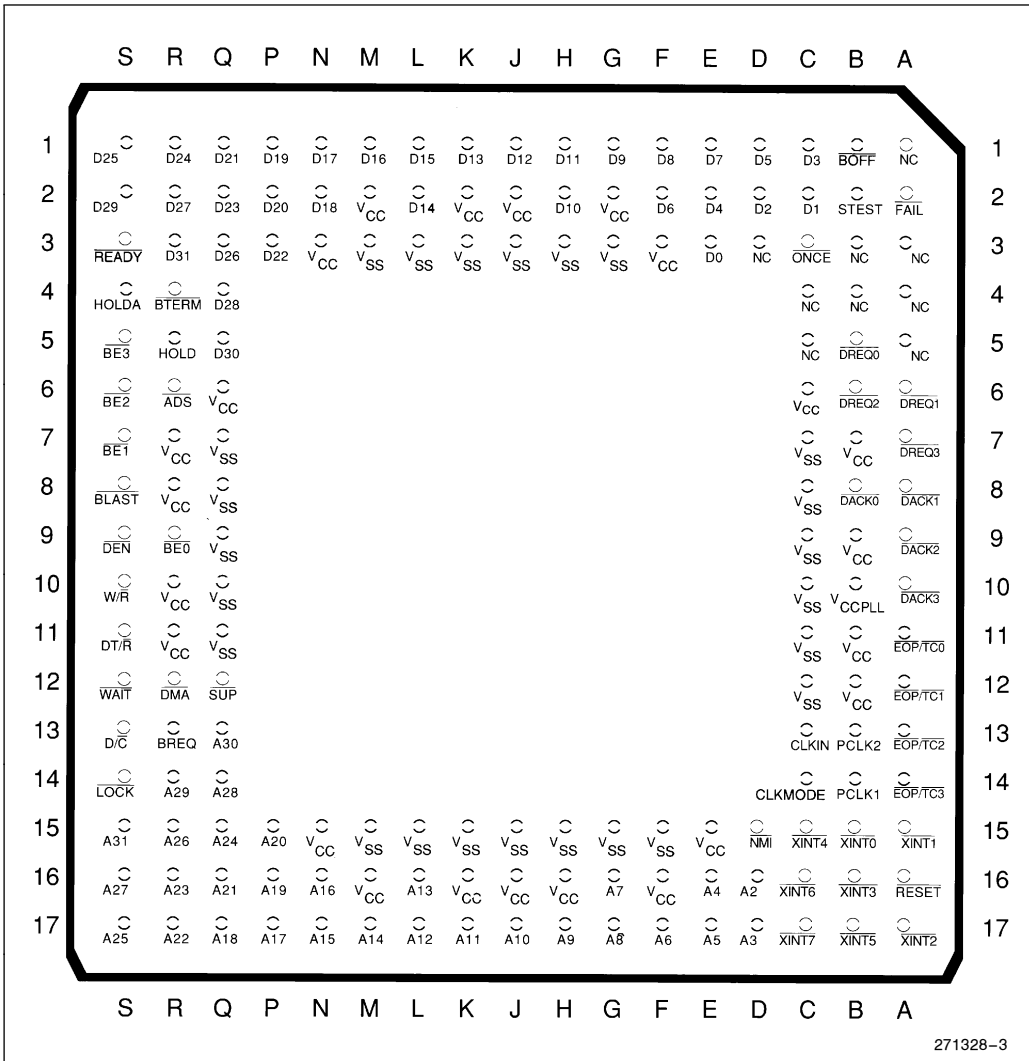

Figure 4a. 80960CF PGA Pinout (View from Top Side)

271328-3

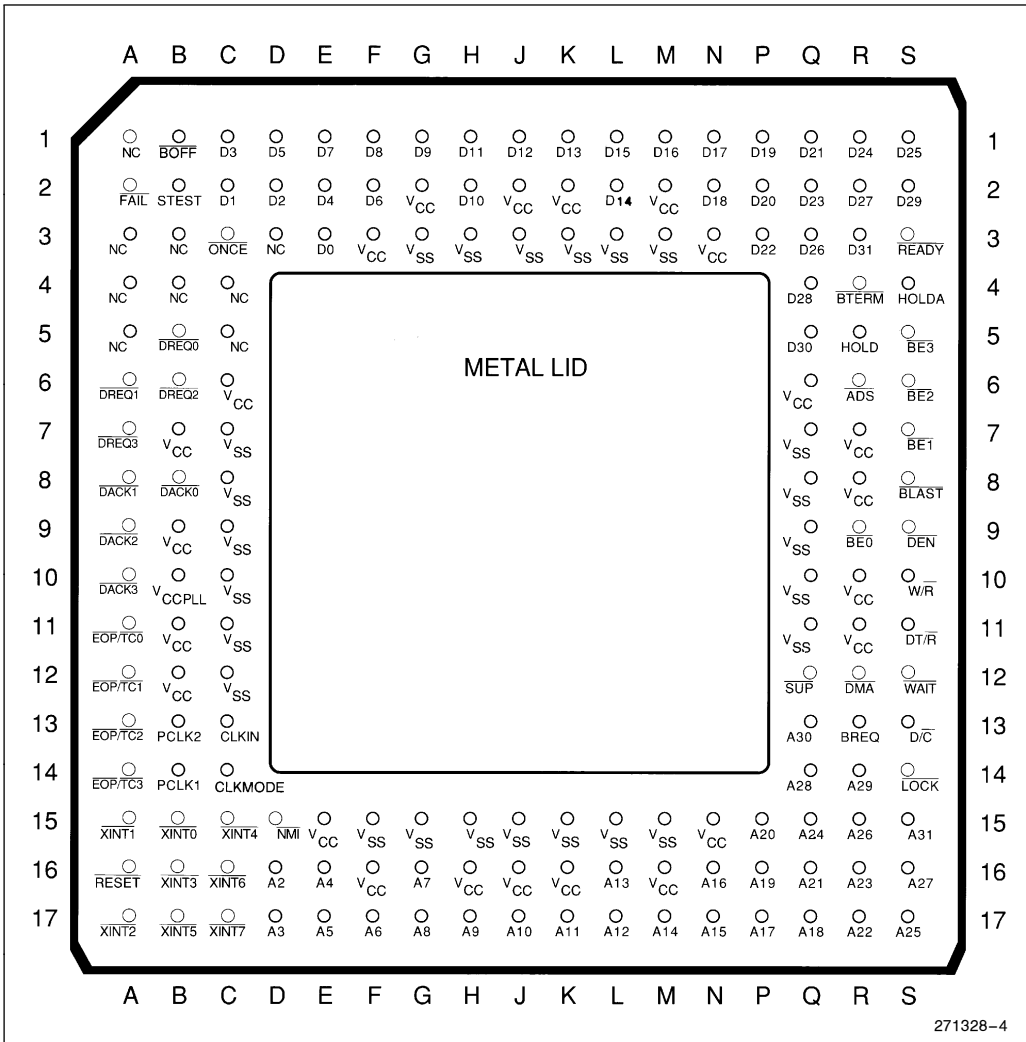
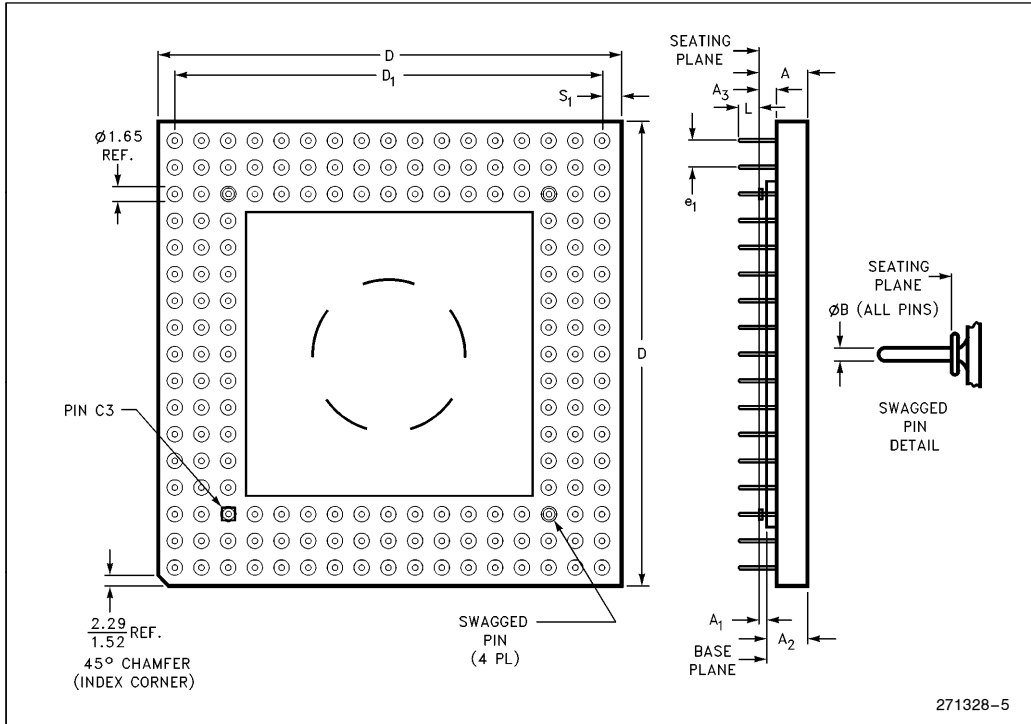

Figure 4b. 80960CF PGA Pinout (View from Bottom Side)

271328-4

3.4. Mechanical Data

3.4.1 CERAMIC PGA PACKAGE



Family: Ceramic Pin Grid Array Package						
Symbol	Millimeters			Inches		
	Min	Max	Notes	Min	Max	Notes
A	3.56	4.57		0.140	0.180	
A ₁	0.64	1.14	SOLID LID	0.025	0.045	SOLID LID
A ₂	23	0.30	SOLID LID	0.110	0.140	SOLID LID
A ₃	1.14	1.40		0.045	0.055	
B	0.43	0.51		0.017	0.020	
D	44.07	44.83		1.735	1.765	
D ₁	40.51	40.77		1.595	1.605	
e ₁	2.29	2.79		0.090	0.110	
L	2.54	3.30		0.100	0.130	
N	168			168		
S ₁	1.52	2.54		0.060	0.100	
ISSUE	IWS REV X 7/15/88					

Figure 5. 168-Lead Ceramic PGA Package Dimensions

Table 7. Ceramic PGA Package Dimension Symbols

Letter or Symbol	Description of Dimensions
A	Distance from seating plane to highest point of body
A ₁	Distance between seating plane and base plane (lid)
A ₂	Distance from base plane to highest point of body
A ₃	Distance from seating plane to bottom of body
B	Diameter of terminal lead pin
D	Largest overall package dimension of length
D ₁	A body length dimension, outer lead center to outer lead center
e ₁	Linear spacing between true lead position centerlines
L	Distance from seating plane to end of lead
S ₁	Other body dimension, outer lead center to edge of body

NOTES:

1. Controlling dimension: millimeter.
2. Dimension "e₁" ("e") is non-cumulative.
3. Seating plane (standoff) is defined by P.C. board hole size: 0.0415–0.0430 inch.
4. Dimensions "B", "B₁" and "C" are nominal.
5. Details of Pin 1 identifier are optional.

3.5. Package Thermal Specifications

The 80960CF is specified for operation when T_C (the case temperature) is within the range of -40°C – $+110^{\circ}\text{C}$. T_C may be measured in any environment to determine whether the 80960CF is within specified operating range. The case temperature is measured at the center of the top surface, opposite the pins. Refer to Figure 7.

T_A (the ambient temperature) can be calculated from θ_{CA} (thermal resistance from case to ambient) with the following equation:

$$T_A = T_C - P \cdot \theta_{CA}$$

Table 8 shows the maximum T_A allowable (without exceeding T_C) at various airflows and operating frequencies (f_{PCLK}).

Note that T_A is greatly improved by attaching fins or a heat sink to the package. P (the maximum power consumption) is calculated by using the typical I_{CC} as tabulated in Section 4.4, **DC Specifications**, and V_{CC} of 5V.

Table 8. Maximum T_A at Various Airflows In $^{\circ}\text{C}$ (PGA Package Only)

	f_{PCLK} (MHz)	Airflow-ft/min (m/sec)					
		0 (0)	200 (1.01)	400 (2.03)	600 (3.04)	800 (4.06)	1000 (5.07)
T_A with Heat Sink*	33 25 16	38 50 63	57 65 74	74 79 84	76 81 86	81 85 89	84 87 90
T_A without Heat Sink	33 25 16	18 34 51	33 46 60	47 57 68	57 65 74	66 72 80	67 74 81

*0.285" high unidirectional heat sink (Al alloy 6061, 50 mil fin width, 150 mil center-to-center fin spacing).

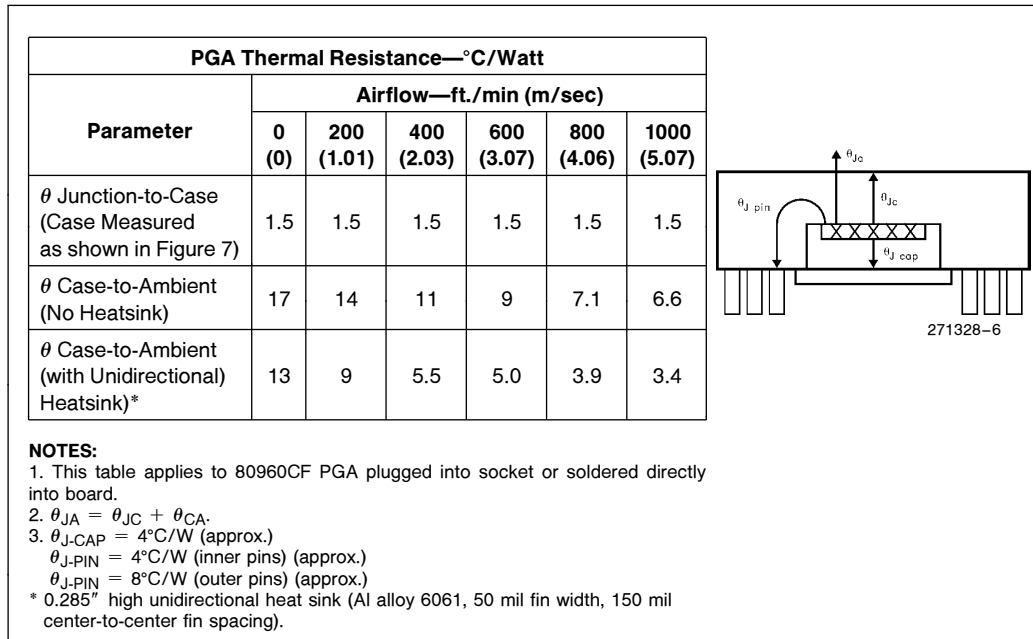

Figure 6. 80960CF PGA Package Thermal Characteristics

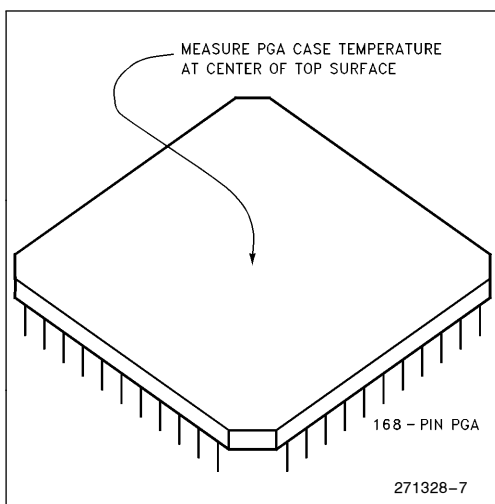

Figure 7. Measuring 80960CF PGA Case Temperature

3.6 Stepping Register Information

Upon Reset, Register G0 contains die stepping information. The following figure shows how G0 is configured. The most significant byte contains an ASCII 0. The upper middle byte contains an ASCII C. The lower middle byte contains an ASCII F. The least significant byte contains the stepping number in ASCII. G0 retains this information until it is written over by the user program.

Table 9 contains a cross reference of the number in the least significant byte of register G0 to the die stepping number.

ASCII	00	43	46	Stepping Number
DECIMAL	0	C	F	Stepping Number
	MSB		LSB	

Figure 8. Register G0

Table 9. Die Stepping Cross Reference

G0 Least Significant Byte	Die Stepping
01	A
02	B
03	C
04	D
05	E

3.7 Suggested Sources for 80960CF Accessories

The following are some suggested sources of accessories for the 80960CF. They are neither an endorsement of any kind, nor a warranty of the performance of any of the listed products and/or companies.

Sockets

- 3M Textool Test and Interconnection Products Department
P.O. Box 2963
Austin, TX 78769-2963
- Augat, Inc.
Interconnection Products Group
33 Perry Avenue
P.O. Box 779
Attleboro, MA 02703
(508) 222-2202
- Concept Manufacturing Inc.
(Decoupling Sockets)
43024 Christy Street
Fremont, CA 94538
(415) 651-3804

Heat Sinks/Fins

- Thermalloy, Inc.
2021 West Valley View Lane
Dallas, TX 75381-0839
(214) 243-4321
- E G & G Division
60 Audubon Road
Wakefield, MA 01880
(617) 245-5900

4.0 ELECTRICAL SPECIFICATIONS

4.1 Absolute Maximum Ratings

Parameter	Maximum Rating
Storage Temperature	-65 °C to +150 °C
Case Temperature Under Bias ⁽²⁾	-40 °C to +125 °C
Supply Voltage wrt. V _{SS}	-0.5V to +6.5V
Voltage on Other pins wrt V _{SS}	-0.5V to V _{CC} + 0.5V

NOTICE: This data sheet contains information on products in the sampling and initial production phases of development. It is valid for the devices indicated in the revision history. The specifications are subject to change without notice.

**WARNING: Stressing the device beyond the "Absolute Maximum Ratings" may cause permanent damage. These are stress ratings only. Operation beyond the "Operating Conditions" is not recommended and extended exposure beyond the "Operating Conditions" may affect device reliability.*

4.2. Operating Conditions

Operating Conditions (80960CF-33, -25, -16)

Symbol	Parameter		Min	Max	Units	Notes
V _{CC}	Supply Voltage	80960CF-30	4.75	5.25	V	
		80960CF-25	4.50	5.50		
		80960CF-16	4.50	5.50		
f _{CLK2x}	Input Clock Frequency (2-x Mode)	80960CF-30	0	60.6	MHz	
		80960CF-25	0	50	MHz	
		80960CF-16	0	32	MHz	
f _{CLK1x}	Input Clock Frequency (1-x Mode)	80960CF-30	8	30.3	MHz	(1)
		80960CF-25	8	25	MHz	
		80960CF-16	8	16	MHz	
T _C	Case Temperature Under Bias 80960CF-30, -25, -16	PGA Package	-40	+110	°C	

NOTES:

(1) When in the 1-x input clock mode, CLKIN is an input to an internal phase-locked loop and must maintain a minimum frequency of 8 MHz for proper processor operation. However, in the 1-x Mode, CLKIN may still be stopped when the processor either is in a reset condition or is reset. If CLKIN is stopped, the specified RESET low time must be provided once CLKIN restarts and has stabilized.

(2) Case temperatures are "Instant On".

4.3 Recommended Connections

Power and ground connections must be made to multiple V_{CC} and V_{SS} (GND) pins. Every 80960CF-based circuit board should include power (V_{CC}) and ground (V_{SS}) planes for power distribution. Every V_{CC} pin must be connected to the power plane, and every V_{SS} pin must be connected to the ground plane. Pins identified as "N.C." **must not** be connected in the system.

Liberal decoupling capacitance should be placed near the 80960CF. The processor can cause transient power surges when its numerous output buffers transition, particularly when connected to large capacitive loads.

Low inductance capacitors and interconnects are recommended for best high frequency electrical performance. Inductance can be reduced by shortening board traces between the processor and decoupling capacitors as much as possible. Capacitors specifically designed for PGA packages will offer the lowest possible inductance.

For reliable operation, always connect unused inputs to an appropriate signal level. In particular, any unused interrupt (XINT, NMI) or DMA (DREQ) input should be connected to V_{CC} through a pull-up resistor, as should BTERM if not used. Pull-up resistors should be in the range of 20 KΩ for each pin tied high. If READY or HOLD are not used, the unused input should be connected to ground. **N.C. pins must always remain unconnected.** Refer to the *i960 CA Microprocessor Reference Manual* for more information.

4.4. DC Specifications

DC Characteristics

 (80960CF-30, -25, -16 under the conditions described in **Section 4.2, Operating Conditions.**)

Symbol	Parameter	Min	Max	Units	Notes
V _{IL}	Input Low Voltage for all pins except $\overline{\text{RESET}}$	-0.3	0.8	V	
V _{IH}	Input High Voltage for all pins except $\overline{\text{RESET}}$	2.0	V _{CC} + 0.3	V	
V _{OL}	Output Low Voltage		0.45	V	I _{OL} = 5 mA
V _{OH}	Output High Voltage	2.4		V	
	I _{OH} = -1 mA	V _{CC} - 0.5		V	
	I _{OH} = -200 μA			V	
V _{ILR}	Input Low Voltage for $\overline{\text{RESET}}$	-0.3	1.5	V	
V _{IHR}	Input High Voltage for $\overline{\text{RESET}}$	3.5	V _{CC} + 0.3	V	
I _{LI1}	Input Leakage Current for each pin <i>except</i> : BTERM, $\overline{\text{ONCE}}$, DREQ3:0, STEST, EOP3:0/TC3:0, NMI, XINT7:0, READY, HOLD, BOFF, CLKMODE		± 15	μA	0V ≤ V _{IN} ≤ V _{CC} (1)
I _{LI2}	Input Leakage Current for: BTERM, $\overline{\text{ONCE}}$, DREQ3:0, STEST, EOP3:0/TC3:0, NMI, XINT7:0, BOFF	0	-325	μA	V _{IN} = 0.45V (2)
I _{LI3}	Input Leakage Current for: READY, HOLD, CLKMODE	0	500	μA	V _{IN} = 2.4V (3)
I _{LO}	Output Leakage Current		± 15	μA	0.45V ≤ V _{OUT} ≤ V _{CC}
I _{CC}	Supply Current (80960CF-30)				
	I _{CC} Max		1150	mA	(4)
	I _{CC} Typ		960	mA	(5)
I _{CC}	Supply Current (80960CF-25)				
	I _{CC} Max		950	mA	(4)
	I _{CC} Typ		775	mA	(5)
I _{CC}	Supply Current (80960CF-16)				
	I _{CC} Max		750	mA	(4)
	I _{CC} Typ		575	mA	(5)
I _{ONCE}	ONCE-mode Supply Current		150	mA	
C _{IN}	Input Capacitance for: CLKIN, $\overline{\text{RESET}}$, $\overline{\text{ONCE}}$, READY, HOLD, DREQ3:0, BOFF XINT7:0, NMI, BTERM, CLKMODE	0	12	pF	F _C = 1 MHz
C _{OUT}	Output Capacitance of each output pin		12	pF	F _C = 1 MHz, (6)
C _{I/O}	I/O Pin Capacitance		12	pF	F _C = 1 MHz

NOTES:

(1) No Pull-up or pull-down.

(2) These pins have internal pullup resistors.

(3) These pins have internal pulldown resistors.

 (4) Measured at worst case frequency, V_{CC} and temperature, with device operating and outputs loaded to the test conditions described in **Section 4.5.1, AC Test Conditions.**

 (5) I_{CC} Typical is not tested.

(6) Output Capacitance is the capacitive load of a floating output.

 (7) CLKMODE pin has a pulldown resistor only when $\overline{\text{ONCE}}$ pin is deasserted.

4.5 AC Specifications

AC Characteristics — 80960CF-30

(80960CF-30 only, under the conditions described in Section 4.2, Operating Conditions and Section 4.5.1, AC Test Conditions.) See notes which follow this table.

Symbol	Parameter	Min	Max	Units	Notes	
INPUT CLOCK(10)						
T_F	CLKIN Frequency	0	60.6	MHz	(1)	
T_C	CLKIN Period	In 1-x Mode (f_{CLK1x})	33	125	ns	(1,12)
		In 2-x Mode (f_{CLK2x})	16.5	∞	ns	(1)
T_{CS}	CLKIN Period Stability	In 1-x Mode (f_{CLK1x})		$\pm 0.1\%$	Δ	(1,13)
T_{CH}	CLKIN High Time	In 1-x Mode (f_{CLK1x})	6	62.5	ns	(1,12)
		In 2-x Mode (f_{CLK2x})	6	∞	ns	(1)
T_{CL}	CLKIN Low Time	In 1-x Mode (f_{CLK1x})	6	62.5	ns	(1,12)
		In 2-x Mode (f_{CLK2x})	6	∞	ns	(1)
T_{CR}	CLKIN Rise Time	0	6	ns	(1)	
T_{CF}	CLKIN Fall Time	0	6	ns	(1)	
OUTPUT CLOCKS(9)						
T_{CP}	CLKIN to PCLK2:1 Delay	In 1-x Mode (f_{CLK1x})	-2	2	ns	(1,3,13,14)
		In 2-x Mode (f_{CLK2x})	2	25	ns	(1,3)
T	PCLK2:1 Period	In 1-x Mode (f_{CLK1x})	T_C		ns	(1,13)
		In 2-x Mode (f_{CLK2x})	$2T_C$		ns	(1,3)
T_{PH}	PCLK2:1 High Time	$(T/2) - 2$	$T/2$	ns	(1,13)	
T_{PL}	PCLK2:1 Low Time	$(T/2) - 2$	$T/2$	ns	(1,13)	
T_{PR}	PCLK2:1 Rise Time	1	4	ns	(1,3)	
T_{PF}	PCLK2:1 Fall Time	1	4	ns	(1,3)	
SYNCHRONOUS OUTPUTS(10)						
T_{OV} T_{OH}	Output Valid Delay, Output Hold				(6, 11)	
	T_{OV1}, T_{OH1}	A31:2	3	14	ns	
	T_{OV2}, T_{OH2}	BE3:0	3	16	ns	
	T_{OV3}, T_{OH3}	ADS	6	18	ns	
	T_{OV4}, T_{OH4}	$\overline{W/R}$	3	18	ns	
	T_{OV5}, T_{OH5}	$\overline{D/C}, \overline{SUP}, \overline{DMA}$	4	16	ns	
	T_{OV6}, T_{OH6}	BLAST, WAIT	5	16	ns	
	T_{OV7}, T_{OH7}	DEN	3	16	ns	
	T_{OV8}, T_{OH8}	HOLDA, BREQ	4	16	ns	
	T_{OV9}, T_{OH9}	LOCK	4	16	ns	
	T_{OV10}, T_{OH10}	DACK3:0	4	18	ns	
	T_{OV11}, T_{OH11}	D31:0	3	16	ns	
	T_{OV12}, T_{OH12}	$\overline{DT/R}$	$T/2 + 3$	$T/2 + 14$	ns	
	T_{OV13}, T_{OH13}	FAIL	2	14	ns	
	T_{OV14}, T_{OH14}	$\overline{EOP/TC3:0}$	3	18	ns	
T_{OF}	Output Float for all outputs		3	22	ns	(6)
SYNCHRONOUS INPUTS(10)						
T_{IS}	Input Setup	D31:0	3		ns	(1,11)
		\overline{BOFF}	17		ns	(1,11)
		$\overline{BTERM/READY}$	7		ns	(1,11)
		HOLD	7		ns	(1,11)
T_{IH}	Input Hold	D31:0	5		ns	(1,11)
		\overline{BOFF}	5		ns	(1,11)
		$\overline{BTERM/READY}$	2		ns	(1,11)
		HOLD	3		ns	(1,11)

AC Characteristics — 80960CF-30

(80960CF-30 only, under the conditions described in **Section 4.2, Operating Conditions** and **Section 4.5.1, AC Test Conditions**.) See notes which follow this table. (Continued)

Symbol	Parameter	Min	Max	Units	Notes
RELATIVE OUTPUT TIMINGS^(9,7)					
T _{AVSH1}	A31:2 Valid to $\overline{\text{ADS}}$ Rising	T - 4	T + 4	ns	
T _{AVSH2}	$\overline{\text{BE}}3:0$, $\overline{\text{W}}/\overline{\text{R}}$, $\overline{\text{SUP}}$, $\overline{\text{D}}/\overline{\text{C}}$, $\overline{\text{DMA}}$, $\overline{\text{DACK}}3:0$ Valid to $\overline{\text{ADS}}$ Rising	T - 6	T + 6	ns	
T _{AVEL1}	A31:2 Valid to $\overline{\text{DEN}}$ Falling	T - 4	T + 4	ns	
T _{AVEL2}	$\overline{\text{BE}}3:0$, $\overline{\text{W}}/\overline{\text{R}}$, $\overline{\text{SUP}}$, $\overline{\text{INST}}$, $\overline{\text{DMA}}$, $\overline{\text{DACK}}3:0$ Valid to $\overline{\text{DEN}}$ Falling	T - 6	T + 6	ns	
T _{NLQV}	$\overline{\text{WAIT}}$ Falling to Output Data Valid	± 6		ns	
T _{DVNH}	Output Data Valid to $\overline{\text{WAIT}}$ Rising	N*T - 6	N*T + 6	ns	(4)
T _{NLNH}	$\overline{\text{WAIT}}$ Falling to $\overline{\text{WAIT}}$ Rising	N*T \pm 4		ns	(4)
T _{NHQX}	Output Data Hold after $\overline{\text{WAIT}}$ Rising	(N + 1) * T - 6	(N + 1) * T + 6	ns	(5)
T _{EHTV}	DT/ $\overline{\text{R}}$ Hold after $\overline{\text{DEN}}$ High	T/2 - 6	∞	ns	(6)
T _{TVEL}	DT/ $\overline{\text{R}}$ Valid to $\overline{\text{DEN}}$ Falling	T/2 - 4	T/2 + 4	ns	(7)
RELATIVE INPUT TIMINGS⁽⁷⁾					
T _{IS5}	$\overline{\text{RESET}}$ Input Setup (2x Clock Mode)	6		ns	(14)
T _{IH5}	$\overline{\text{RESET}}$ Input Hold (2x Clock Mode)	5		ns	(14)
T _{IS6}	$\overline{\text{DREQ}}3:0$ Input Setup	12		ns	(8)
T _{IH6}	$\overline{\text{DREQ}}3:0$ Input Hold	7		ns	(8)
T _{IS7}	$\overline{\text{XINT}}7:0$, $\overline{\text{NMI}}$ Input Setup	7		ns	(8)
T _{IH7}	$\overline{\text{XINT}}7:0$, $\overline{\text{NMI}}$ Input Hold	3		ns	(8)
T _{IS8}	$\overline{\text{RESET}}$ Input Setup (1x Clock Mode)	3		ns	(15)
T _{IH8}	$\overline{\text{RESET}}$ Input Hold (1x Clock Mode)	T/4 + 1		ns	(15)

NOTES:

- See **Section 4.5.2, AC Timing Waveforms** for waveforms and definitions.
- See Figure 22 for capacitive derating information for output delays and hold times.
- See Figure 23 for capacitive derating information for rise and fall times.
- Where N is the number of $\overline{\text{N}}\overline{\text{RAD}}$, $\overline{\text{N}}\overline{\text{RDD}}$, $\overline{\text{N}}\overline{\text{WAD}}$, or $\overline{\text{N}}\overline{\text{WDD}}$ wait states that are programmed in the Bus Controller Region Table. When there are no wait states in an access, $\overline{\text{WAIT}}$ never goes active.
- N = Number of wait states inserted with $\overline{\text{READY}}$.
- Output Data and/or DT/ $\overline{\text{R}}$ may be driven indefinitely following a cycle if there is no subsequent bus activity.
- See Notes 1, 2 and 3.
- Since asynchronous inputs are synchronized internally by the 80960CF they have no required setup or hold times in order to be recognized and for proper operation. However, to guarantee recognition of the input at a particular edge of PCLK2:1 the setup times shown must be met. Asynchronous inputs must be active for at least two consecutive PCLK2:1 rising edges to be seen by the processor.
- These specifications are guaranteed by the processor.
- These specifications must be met by the system for proper operation of the processor.
- This timing is dependent upon the loading of PCLK2:1. Use the derating curves of **Section 4.5.3** to adjust the timing for PCLK2:1 loading.
- In the 1-x input clock mode, the maximum input clock period is limited to 125 ns while the processor is operating. When the processor is in reset, the input clock may stop even in 1-x mode.
- When in the 1-x input clock mode, these specifications assume a stable input clock with a period variation of less than $\pm 0.1\%$ between adjacent cycles.
- In 2x clock mode, $\overline{\text{RESET}}$ is an asynchronous input which has no required setup and hold time for proper operation. However, to guarantee the device exits reset synchronized to a particular clock edge, the $\overline{\text{RESET}}$ pin must meet setup and hold times to the falling edge of the CLKIN. (See Figure 28a.)
- In 1x clock mode, $\overline{\text{RESET}}$ is an asynchronous input which has no required setup and hold time for proper operation. However, to guarantee the device exits reset synchronized to a particular clock edge, the $\overline{\text{RESET}}$ pin must be deasserted while CLKIN is high and meet setup and hold times to the rising edge of the CLKIN. (See Figure 28b.)

AC Characteristics — 80960CF-25

(80960CF-25 only, under the conditions described in Section 4.2, Operating Conditions and Section 4.5.1, AC Test Conditions.)

Symbol	Parameter	Min	Max	Units	Notes	
INPUT CLOCK⁽¹⁰⁾						
T _F	CLKIN Frequency	0	50	MHz	(1)	
T _C	CLKIN Period	In 1-x Mode (f _{CLK1x})	40	125	ns	(1,12)
		In 2-x Mode (f _{CLK2x})	20	∞	ns	(1)
T _{CS}	CLKIN Period Stability	In 1-x Mode (f _{CLK1x})		±0.1%	Δ	(1,13)
T _{CH}	CLKIN High Time	In 1-x Mode (f _{CLK1x})	8	62.5	ns	(1,12)
		In 2-x Mode (f _{CLK2x})	8	∞	ns	(1)
T _{CL}	CLKIN Low Time	In 1-x Mode (f _{CLK1x})	8	62.5	ns	(1,12)
		In 2-x Mode (f _{CLK2x})	8	∞	ns	(1)
T _{CR}	CLKIN Rise Time		0	6	ns	(1)
T _{CF}	CLKIN Fall Time		0	6	ns	(1)
OUTPUT CLOCKS⁽⁹⁾						
T _{CP}	CLKIN to PCLK2:1 Delay	In 1-x Mode (f _{CLK1x})	-2	2	ns	(1,3,13,14)
		In 2-x Mode (f _{CLK2x})	2	25	ns	(1,3)
T	PCLK2:1 Period	In 1-x Mode (f _{CLK1x})	T _C		ns	(1,13)
		In 2-x Mode (f _{CLK2x})	2T _C		ns	(1,3)
T _{PH}	PCLK2:1 High Time	(T/2) - 3	T/2	ns	(1,13)	
T _{PL}	PCLK2:1 Low Time	(T/2) - 3	T/2	ns	(1,13)	
T _{PR}	PCLK2:1 Rise Time	1	4	ns	(1,3)	
T _{PF}	PCLK2:1 Fall Time	1	4	ns	(1,3)	
SYNCHRONOUS OUTPUTS⁽¹⁰⁾						
T _{OV} T _{OH}	Output Valid Delay, Output Hold				(6, 11)	
	T _{OV1} , T _{OH1}	A31:2	3	16	ns	
	T _{OV2} , T _{OH2}	BE3:0	3	18	ns	
	T _{OV3} , T _{OH3}	ADS	6	20	ns	
	T _{OV4} , T _{OH4}	W/R	3	20	ns	
	T _{OV5} , T _{OH5}	D/C, SUP, DMA	4	18	ns	
	T _{OV6} , T _{OH6}	BLAST, WAIT	5	18	ns	
	T _{OV7} , T _{OH7}	DEN	3	18	ns	
	T _{OV8} , T _{OH8}	HOLDA, BREQ	4	18	ns	
	T _{OV9} , T _{OH9}	LOCK	4	18	ns	
	T _{OV10} , T _{OH10}	DACK3:0	4	20	ns	
	T _{OV11} , T _{OH11}	D31:0	3	18	ns	
	T _{OV12} , T _{OH12}	DT/R	T/2 + 3	T/2 + 16	ns	
	T _{OV13} , T _{OH13}	FAIL	2	16	ns	
	T _{OV14} , T _{OH14}	EOP3:0/TC3:0	3	20	ns	(6, 11)
T _{OF}	Output Float for all outputs		3	22	ns	(6)
SYNCHRONOUS INPUTS⁽¹⁰⁾						
T _{IS}	Input Setup	D31:0	5		ns	(1,11)
		BOFF	19		ns	(1,11)
		BTERM/READY	9		ns	(1,11)
		HOLD	9		ns	(1,11)
T _{IH}	Input Hold	D31:0	5		ns	(1,11)
		BOFF	7		ns	(1,11)
		BTERM/READY	2		ns	(1,11)
		HOLD	5		ns	(1,11)

AC Characteristics — 80960CF-25

(80960CF-25 only, under the conditions described in **Section 4.2, Operating Conditions** and **Section 4.5.1, AC Test Conditions.**) (Continued)

Symbol	Parameter	Min	Max	Units	Notes
RELATIVE OUTPUT TIMINGS^(9,7)					
T _{AVSH1}	A31:2 Valid to \overline{ADS} Rising	T - 4	T + 4	ns	
T _{AVSH2}	$\overline{BE3:0}$, $\overline{W/R}$, \overline{SUP} , $\overline{D/C}$, \overline{DMA} , $\overline{DACK3:0}$ Valid to \overline{ADS} Rising	T - 6	T + 6	ns	
T _{AVEL1}	A31:2 Valid to \overline{DEN} Falling	T - 4	T + 4	ns	
T _{AVEL2}	$\overline{BE3:0}$, $\overline{W/R}$, \overline{SUP} , \overline{INST} , \overline{DMA} , $\overline{DACK3:0}$ Valid to \overline{DEN} Falling	T - 6	T + 6	ns	
T _{NLQV}	\overline{WAIT} Falling to Output Data Valid	± 6		ns	
T _{DVNH}	Output Data Valid to \overline{WAIT} Rising	N*T - 6	N*T + 6	ns	(4)
T _{NLNH}	\overline{WAIT} Falling to \overline{WAIT} Rising	N*T \pm 4		ns	(4)
T _{NHQX}	Output Data Hold after \overline{WAIT} Rising	(N + 1) * T - 6	(N + 1) * T + 6	ns	(5)
T _{EHTV}	DT/ \overline{R} Hold after \overline{DEN} High	T/2 - 6	∞	ns	(6)
T _{TVEL}	DT/ \overline{R} Valid to \overline{DEN} Falling	T/2 - 4	T/2 + 4	ns	(7)
RELATIVE INPUT TIMINGS⁽⁷⁾					
T _{IS5}	\overline{RESET} Input Setup (2x Clock Mode)	8		ns	(14)
T _{IH5}	\overline{RESET} Input Hold (2x Clock Mode)	7		ns	(14)
T _{IS6}	$\overline{DREQ3:0}$ Input Setup	14		ns	(8)
T _{IH6}	$\overline{DREQ3:0}$ Input Hold	9		ns	(8)
T _{IS7}	$\overline{XINT7:0}$, \overline{NMI} Input Setup	9		ns	(8)
T _{IH7}	$\overline{XINT7:0}$, \overline{NMI} Input Hold	5		ns	(8)
T _{IS8}	\overline{RESET} Input Setup (1x Clock Mode)	3		ns	(15)
T _{IH8}	\overline{RESET} Input Hold (1x Clock Mode)	T/4 + 1		ns	(15)

NOTES:

- (1) See **Section 4.5.2, AC Timing Waveforms** for waveforms and definitions.
- (2) See Figure 22 for capacitive derating information for output delays and hold times.
- (3) See Figure 23 for capacitive derating information for rise and fall times.
- (4) Where N is the number of $\overline{N_{RAD}}$, $\overline{N_{RDD}}$, $\overline{N_{WAD}}$, or $\overline{N_{WDD}}$ wait states that are programmed in the Bus Controller Region Table. When there are no wait states in an access, \overline{WAIT} never goes active.
- (5) N = Number of wait states inserted with \overline{READY} .
- (6) Output Data and/or DT/ \overline{R} may be driven indefinitely following a cycle if there is no subsequent bus activity.
- (7) See Notes 1, 2 and 3.
- (8) Since asynchronous inputs are synchronized internally by the 80960CF they have no required setup or hold times in order to be recognized and for proper operation. However, to guarantee recognition of the input at a particular edge of PCLK2:1 the setup times shown must be met. Asynchronous inputs must be active for at least two consecutive PCLK2:1 rising edges to be seen by the processor.
- (9) These specifications are guaranteed by the processor.
- (10) These specifications must be met by the system for proper operation of the processor.
- (11) This timing is dependent upon the loading of PCLK2:1. Use the derating curves of **Section 4.5.3** to adjust the timing for PCLK2:1 loading.
- (12) In the 1-x input clock mode, the maximum input clock period is limited to 125 ns while the processor is operating. When the processor is in reset, the input clock may stop even in 1-x mode.
- (13) When in the 1-x input clock mode, these specifications assume a stable input clock with a period variation of less than $\pm 0.1\%$ between adjacent cycles.
- (14) In 2x clock mode, \overline{RESET} is an asynchronous input which has no required setup and hold time for proper operation. However, to guarantee the device exits reset synchronized to a particular clock edge, the \overline{RESET} pin must meet setup and hold times to the falling edge of the CLKIN. (See Figure 28a.)
- (15) In 1x clock mode, \overline{RESET} is an asynchronous input which has no required setup and hold time for proper operation. However, to guarantee the device exits reset synchronized to a particular clock edge, the \overline{RESET} pin must be deasserted while CLKIN is high and meet setup and hold times to the rising edge of the CLKIN. (See Figure 28b.)



AC Characteristics — 80960CF-16

(80960CF-16 only, under the conditions described in **Section 4.2, Operating Conditions** and **Section 4.5.1, AC Test Conditions.**) (Continued)

Symbol	Parameter	Min	Max	Units	Notes	
INPUT CLOCK⁽¹⁰⁾						
T _F	CLKIN Frequency	0	32	MHz	(1)	
T _C	CLKIN Period	In 1-x Mode (f _{CLK1x})	62.5	125	ns	(1,12)
		In 2-x Mode (f _{CLK2x})	31.25	∞	ns	(1)
T _{CS}	CLKIN Period Stability	In 1-x Mode (f _{CLK1x})		±0.1%	Δ	(1,13)
T _{CH}	CLKIN High Time	In 1-x Mode (f _{CLK1x})	10	62.5	ns	(1,12)
		In 2-x Mode (f _{CLK2x})	10	∞	ns	(1)
T _{CL}	CLKIN Low Time	In 1-x Mode (f _{CLK1x})	10	62.5	ns	(1,12)
		In 2-x Mode (f _{CLK2x})	10	∞	ns	(1)
T _{CR}	CLKIN Rise Time	0	6	ns	(1)	
T _{CF}	CLKIN Fall Time	0	6	ns	(1)	
OUTPUT CLOCKS⁽⁹⁾						
T _{CP}	CLKIN to PCLK2:1 Delay	In 1-x Mode (f _{CLK1x})	-2	2	ns	(1,3,13,14)
		In 2-x Mode (f _{CLK2x})	2	25	ns	(1,3)
T	PCLK2:1 Period	In 1-x Mode (f _{CLK1x})	T _C		ns	(1,13)
		In 2-x Mode (f _{CLK2x})	2T _C		ns	(1,3)
T _{PH}	PCLK2:1 High Time	(T/2) - 4	T/2	ns	(1,13)	
T _{PL}	PCLK2:1 Low Time	(T/2) - 4	T/2	ns	(1,13)	
T _{PR}	PCLK2:1 Rise Time	1	4	ns	(1,3)	
T _{PF}	PCLK2:1 Fall Time	1	4	ns	(1,3)	
SYNCHRONOUS OUTPUTS⁽¹⁰⁾						
T _{OV} T _{OH}	Output Valid Delay, Output Hold					(6, 11)
	T _{OV1} , T _{OH1}	A31:2	3	18	ns	
	T _{OV2} , T _{OH2}	BE3:0	3	20	ns	
	T _{OV3} , T _{OH3}	ADS	6	22	ns	
	T _{OV4} , T _{OH4}	W/R	3	22	ns	
	T _{OV5} , T _{OH5}	D/C, SUP, DMA	4	20	ns	
	T _{OV6} , T _{OH6}	BLAST, WAIT	5	20	ns	
	T _{OV7} , T _{OH7}	DEN	3	20	ns	
	T _{OV8} , T _{OH8}	HOLDA, BREQ	4	20	ns	
	T _{OV9} , T _{OH9}	LOCK	4	20	ns	
	T _{OV10} , T _{OH10}	DACK3:0	4	22	ns	
	T _{OV11} , T _{OH11}	D31:0	3	20	ns	
	T _{OV12} , T _{OH12}	DT/R	T/2 + 3	T/2 + 18	ns	
	T _{OV13} , T _{OH13}	FAIL	2	18	ns	
	T _{OV14} , T _{OH14}	EOP3:0/TC3:0	3	22	ns	(6, 11)
T _{OF}	Output Float for all outputs	3	22	ns	(6)	
SYNCHRONOUS INPUTS⁽¹⁰⁾						
T _{IS}	Input Setup					
	T _{IS1}	D31:0	5		ns	(1,11)
	T _{IS2}	BOFF	21		ns	(1,11)
	T _{IS3}	BTERM/READY	9		ns	(1,11)
	T _{IS4}	HOLD	9		ns	(1,11)
T _{IH}	Input Hold					
	T _{IH1}	D31:0	5		ns	(1,11)
	T _{IH2}	BOFF	7		ns	(1,11)
	T _{IH3}	BTERM/READY	2		ns	(1,11)
	T _{IH4}	HOLD	5		ns	(1,11)

AC Characteristics — 80960CF-16

(80960CF-16 only, under the conditions described in **Section 4.2, Operating Conditions** and **Section 4.5.1, AC Test Conditions.**) (Continued)

Symbol	Parameter	Min	Max	Units	Notes
RELATIVE OUTPUT TIMINGS(9,7)					
T _{AVSH1}	A31:2 Valid to $\overline{\text{ADS}}$ Rising	T - 4	T + 4	ns	
T _{AVSH2}	$\overline{\text{BE3:0}}$, W/R, $\overline{\text{SUP}}$, D/ $\overline{\text{C}}$, DMA, $\overline{\text{DACK3:0}}$ Valid to $\overline{\text{ADS}}$ Rising	T - 6	T + 6	ns	
T _{AVEL1}	A31:2 Valid to $\overline{\text{DEN}}$ Falling	T - 6	T + 6	ns	
T _{AVEL2}	$\overline{\text{BE3:0}}$, W/R, $\overline{\text{SUP}}$, $\overline{\text{INST}}$, DMA, $\overline{\text{DACK3:0}}$ Valid to $\overline{\text{DEN}}$ Falling	T - 6	T + 6	ns	
T _{NLQV}	$\overline{\text{WAIT}}$ Falling to Output Data Valid	± 6		ns	
T _{DVNH}	Output Data Valid to $\overline{\text{WAIT}}$ Rising	N*T - 6	N*T + 6	ns	(4)
T _{NLNH}	$\overline{\text{WAIT}}$ Falling to $\overline{\text{WAIT}}$ Rising	N*T \pm 4		ns	(4)
T _{NHQX}	Output Data Hold after $\overline{\text{WAIT}}$ Rising	(N + 1) * T - 6	(N + 1) * T + 6	ns	(5)
T _{EHTV}	DT/ $\overline{\text{R}}$ Hold after $\overline{\text{DEN}}$ High	T/2 - 6	∞	ns	(6)
T _{TVEL}	DT/ $\overline{\text{R}}$ Valid to $\overline{\text{DEN}}$ Falling	T/2 - 4	T/2 + 4	ns	(7)
RELATIVE INPUT TIMINGS(7)					
T _{IS5}	$\overline{\text{RESET}}$ Input Setup (2x Clock Mode)	10		ns	(14)
T _{IH5}	$\overline{\text{RESET}}$ Input Hold (2x Clock Mode)	9		ns	(14)
T _{IS6}	$\overline{\text{DREQ3:0}}$ Input Setup	16		ns	(8)
T _{IH6}	$\overline{\text{DREQ3:0}}$ Input Hold	11		ns	(8)
T _{IS7}	XINT7:0, $\overline{\text{NMI}}$ Input Setup	9		ns	(8)
T _{IH7}	XINT7:0, $\overline{\text{NMI}}$ Input Hold	5		ns	(8)
T _{IS8}	$\overline{\text{RESET}}$ Input Setup (1x Clock Mode)	3		ns	(15)
T _{IH8}	$\overline{\text{RESET}}$ Input Hold (1x Clock Mode)	T/4 + 1		ns	(15)

NOTES:

- (1) See **Section 4.5.2, AC Timing Waveforms** for waveforms and definitions.
- (2) See Figure 22 for capacitive derating information for output delays and hold times.
- (3) See Figure 23 for capacitive derating information for rise and fall times.
- (4) Where N is the number of N_{RAD}, N_{RDD}, N_{WAD}, or N_{WDD} wait states that are programmed in the Bus Controller Region Table. When there are no wait states in an access, $\overline{\text{WAIT}}$ never goes active.
- (5) N = Number of wait state inserted with $\overline{\text{READY}}$.
- (6) Output Data and/or DT/ $\overline{\text{R}}$ may be driven indefinitely following a cycle if there is no subsequent bus activity.
- (7) See Notes 1, 2 and 3.
- (8) Since asynchronous inputs are synchronized internally by the 80960CF they have no required setup or hold times in order to be recognized and for proper operation. However, to guarantee recognition of the input at a particular edge of PCLK2:1 the setup times shown must be met. Asynchronous inputs must be active for at least two consecutive PCLK2:1 rising edges to be seen by the processor.
- (9) These specifications are guaranteed by the processor.
- (10) These specifications must be met by the system for proper operation of the processor.
- (11) This timing is dependent upon the loading of PCLK2:1. Use the derating curves of Figure 22 to adjust the timing for PCLK2:1 loading.
- (12) In the 1-x input clock mode, the maximum input clock period is limited to 125 ns while the processor is operating. When the processor is in reset, the input clock may stop even in 1-x mode.
- (13) When in the 1-x input clock mode, these specifications assume a stable input clock with a period variation of less than $\pm 0.1\%$ between adjacent cycles.
- (14) In 2x clock mode, $\overline{\text{RESET}}$ is an asynchronous input which has no required setup and hold time for proper operation. However, to guarantee the device exits reset synchronized to a particular clock edge, the $\overline{\text{RESET}}$ pin must meet setup and hold times to the falling edge of the CLKIN. (See Figure 28a.)
- (15) In 1x clock mode, $\overline{\text{RESET}}$ is an asynchronous input which has no required setup and hold time for proper operation. However, to guarantee the device exits reset synchronized to a particular clock edge, the $\overline{\text{RESET}}$ pin must be deasserted while CLKIN is high and meet setup and hold times to the rising edge of the CLKIN. (See Figure 28b.)

4.5.1. AC TEST CONDITIONS

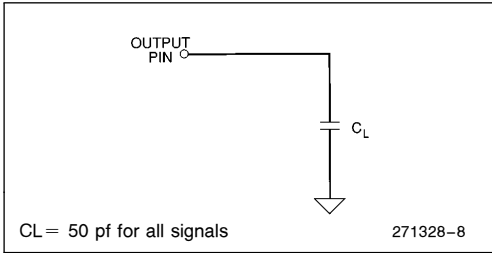

Figure 9. AC Test Load

The AC Specifications in Section 4.5 are tested with the 50 pf load shown in Figure 9. See Figure 16 to see how timings vary with load capacitance.

Specifications are measured at the 1.5V crossing point, unless otherwise indicated. Input waveforms are assumed to have a rise-and-fall time of ≤ 2 ns from 0.8V to 2.0V. See **Section 4.5.2, AC Timing Waveforms** for AC spec definitions, test points and illustrations.

4.5.2. AC TIMING WAVEFORMS

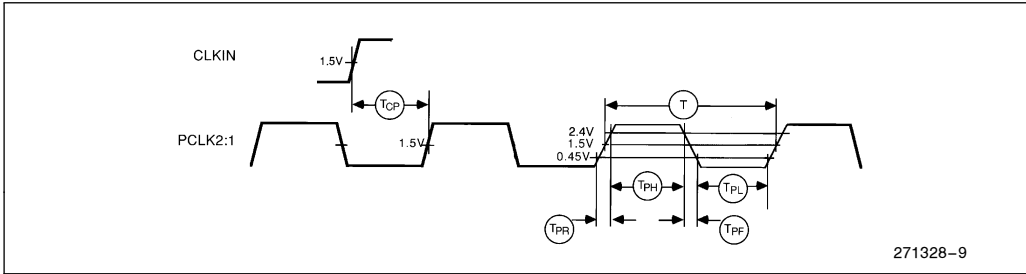

Figure 10a. Input and Output Clocks Waveform

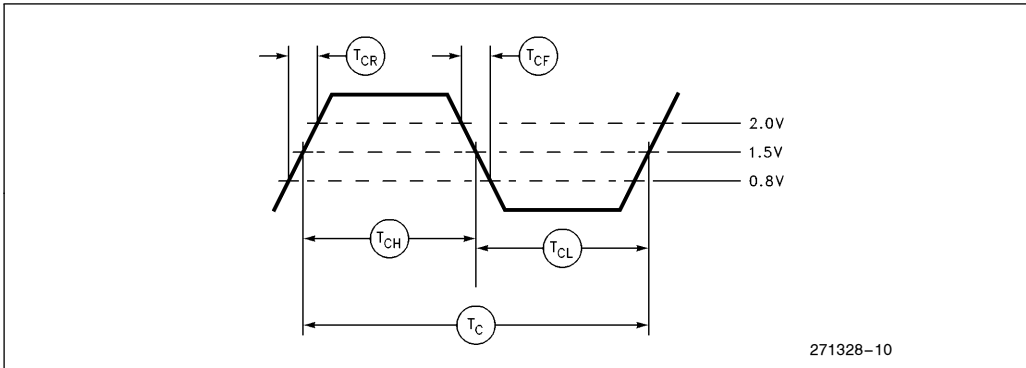

Figure 10b. CLKIN Waveform

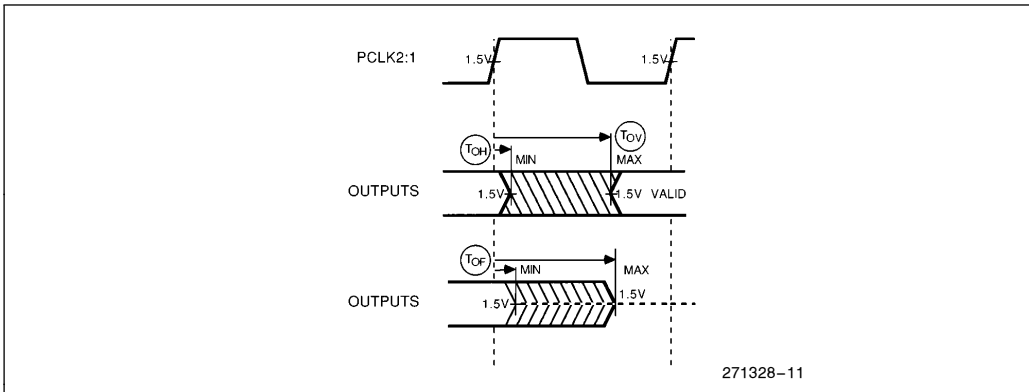

Figure 11. Output Delay and Float Waveform

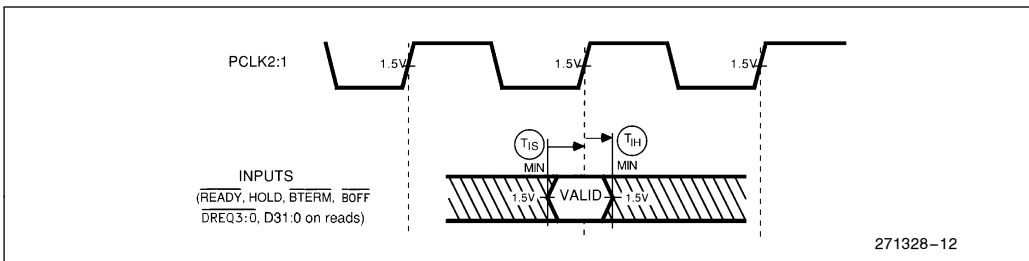

Figure 12a. Input Setup and Hold Waveform

- T_{OV} T_{OH} — OUTPUT DELAY — The maximum output delay is referred to as the Output Valid Delay (T_{OV}). The minimum output delay is referred to as the Output Hold (T_{OH}).
- T_{OF} — OUTPUT FLOAT DELAY — The output float condition occurs when the maximum output current becomes less than I_{LO} in magnitude.
- T_{IS} T_{IH} — INPUT SETUP AND HOLD — The input setup and hold requirements specify the sampling window during which synchronous inputs must be stable for correct processor operation.

271328-13

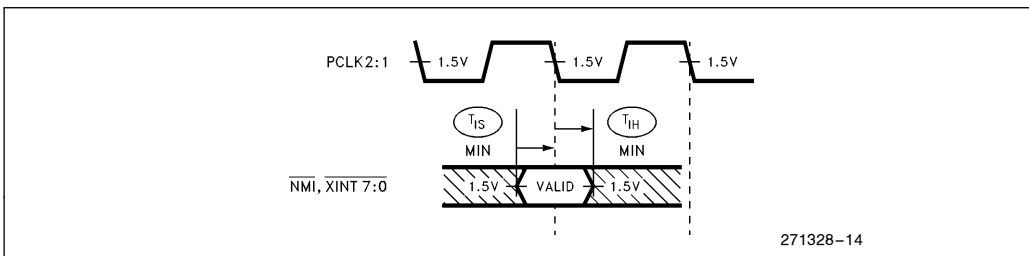

Figure 12b. NMI, XINT7:0 Input Setup and Hold Waveform

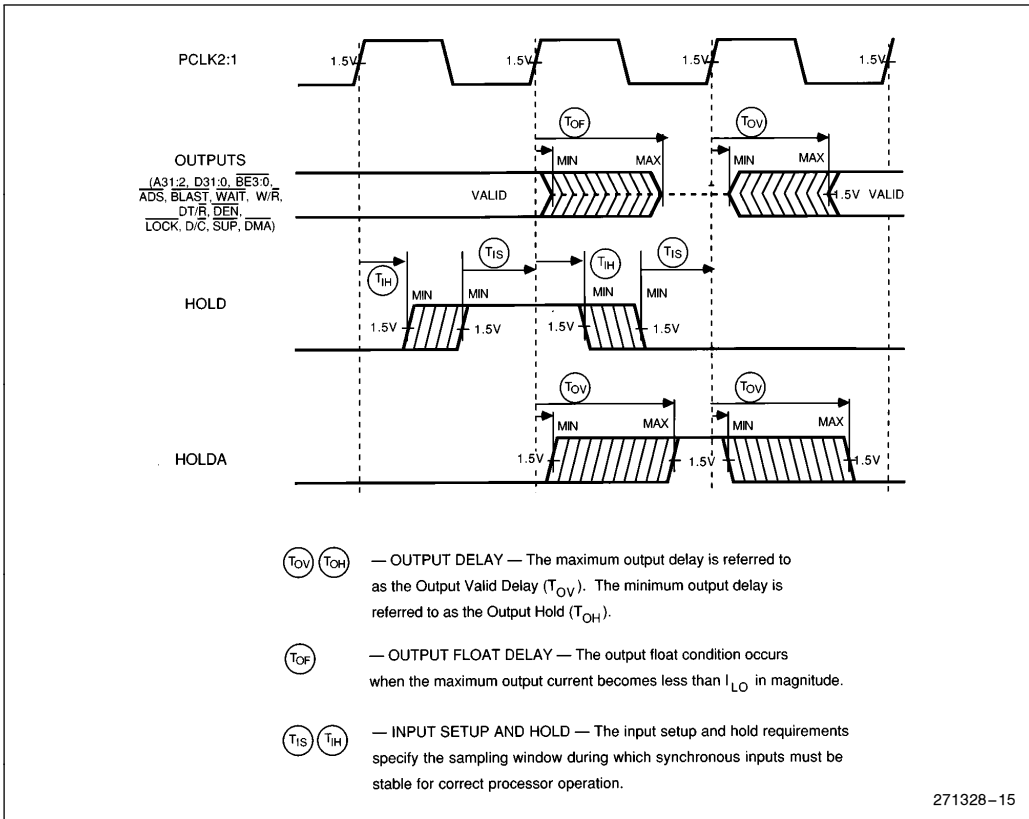

Figure 13. Hold Acknowledge Timings

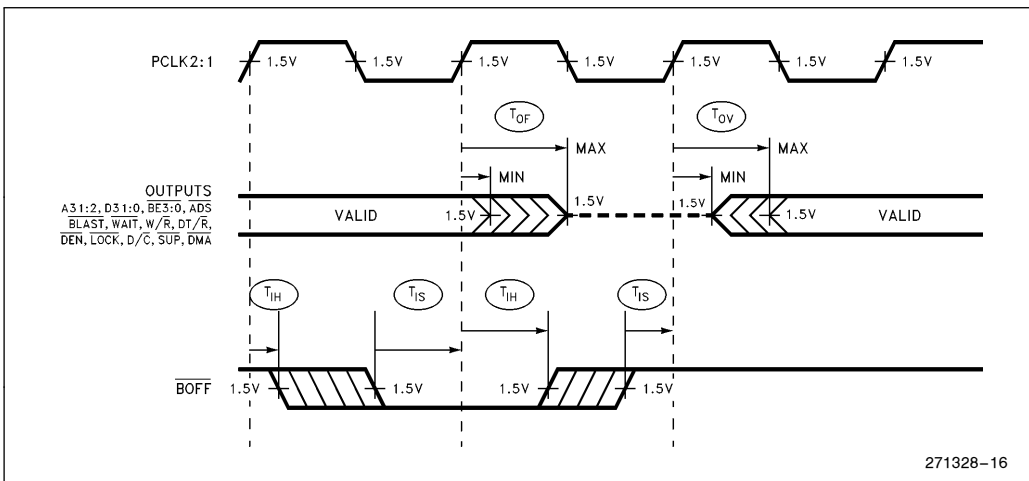

Figure 14. Bus Back-Off (BOFF) Timings

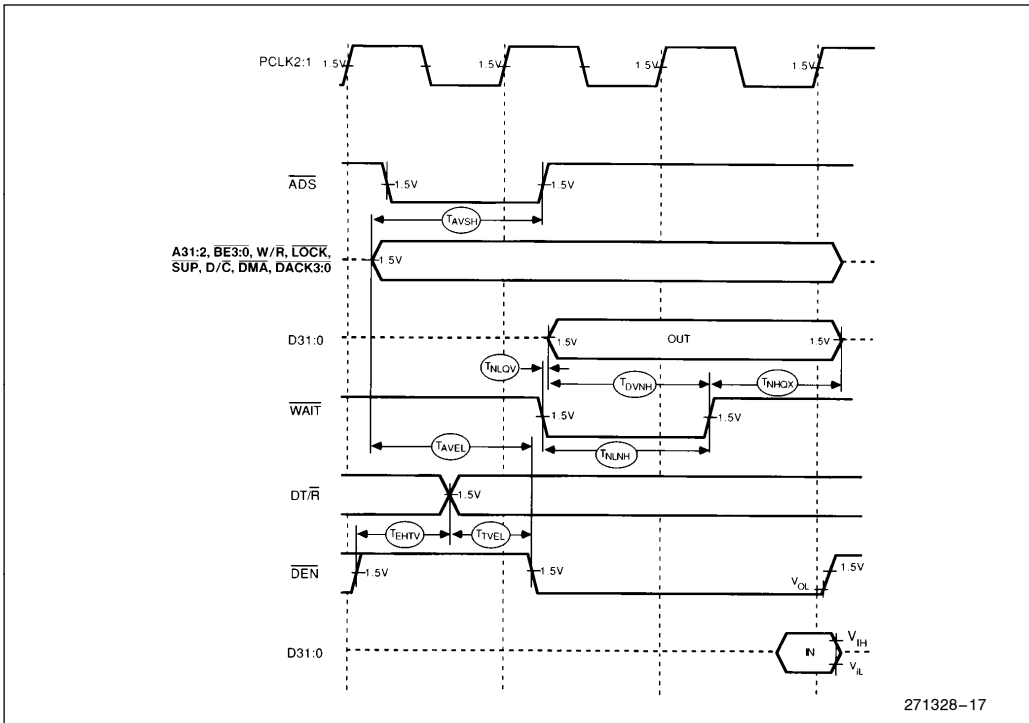

Figure 15. Relative Timings Waveforms

4.5.3 DERATING CURVES

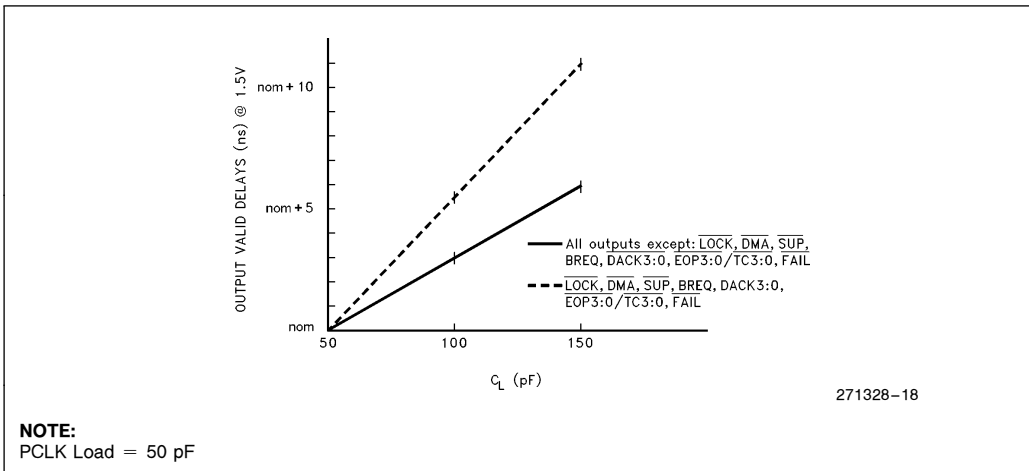

Figure 16. Output Delay or Hold vs Load Capacitance

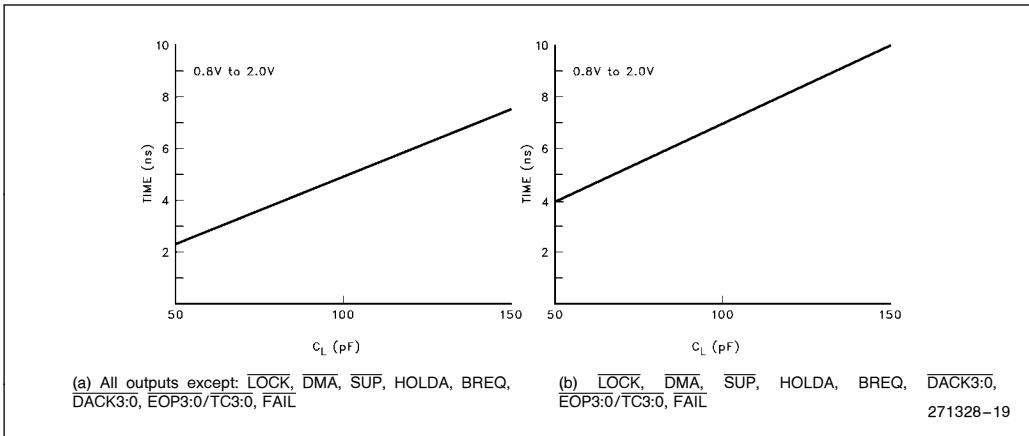

Figure 17. Rise and Fall Time Derating at Highest Operating Temperature and Minimum V_{CC}

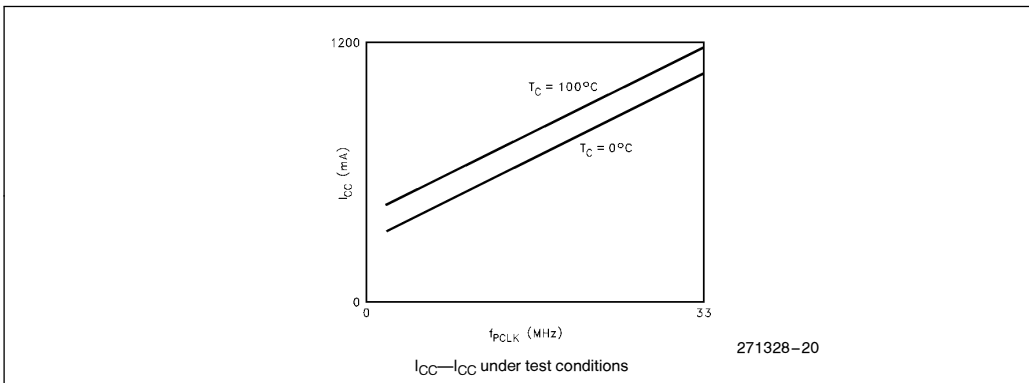

Figure 18. I_{CC} vs Frequency and Temperature

5.0 RESET, BACKOFF AND HOLD ACKNOWLEDGE

The following table lists the condition of each processor output pin while $\overline{\text{RESET}}$ is asserted (low).

Table 10. Reset Conditions

Pins	State During Reset (HOLDA inactive) ¹
A31:A2	Floating
D31:D0	Floating
$\overline{\text{BE}}3:0$	Driven high (Inactive)
$\text{W}/\overline{\text{R}}$	Driven low (Read)
$\overline{\text{ADS}}$	Driven high (Inactive)
$\overline{\text{WAIT}}$	Driven high (Inactive)
$\overline{\text{BLAST}}$	Driven low (Active)
$\text{DT}/\overline{\text{R}}$	Driven low (Receive)
$\overline{\text{DEN}}$	Driven high (Inactive)
$\overline{\text{LOCK}}$	Driven high (Inactive)
BREQ	Driven low (Inactive)
$\text{D}/\overline{\text{C}}$	Floating
$\overline{\text{DMA}}$	Floating
$\overline{\text{SUP}}$	Floating
$\overline{\text{FAIL}}$	Driven low (Active)
$\overline{\text{DACK}}3$	Driven high (Inactive)
$\overline{\text{DACK}}2$	Driven high (Inactive)
$\overline{\text{DACK}}1$	Driven high (Inactive)
$\overline{\text{DACK}}0$	Driven high (Inactive)
$\overline{\text{EOP}}/\overline{\text{TC}}3$	Floating (set to input mode)
$\overline{\text{EOP}}/\overline{\text{TC}}2$	Floating (set to input mode)
$\overline{\text{EOP}}/\overline{\text{TC}}1$	Floating (set to input mode)
$\overline{\text{EOP}}/\overline{\text{TC}}0$	Floating (set to input mode)

NOTE:

(1) With regard to bus output pin state only, the Hold Acknowledge state takes precedence over the reset state. Although asserting the $\overline{\text{RESET}}$ pin will internally reset the processor, the processor's bus output pins will not enter the reset state if it has granted Hold Acknowledge to a previous HOLD request (HOLDA is active). Furthermore, the processor will grant new HOLD requests and enter the Hold Acknowledge state even while in reset. For example, if HOLDA is not active and the processor is in the reset state, then HOLD is asserted, the processor's bus pins will enter the Hold Acknowledge state and HOLDA will be granted. The processor will not be able to perform memory accesses until the HOLD request is removed, even if the $\overline{\text{RESET}}$ pin is brought high. This operation is provided to simplify boot-up synchronization among multiple processors sharing the same bus.

The following table lists the condition of each processor output pin while HOLDA is asserted (low).

Table 11. Hold Acknowledge and Backoff Conditions

Pins	State During HOLDA
A31:A2	Floating
D31:D0	Floating
$\overline{\text{BE}}3:0$	Floating
$\text{W}/\overline{\text{R}}$	Floating
$\overline{\text{ADS}}$	Floating
$\overline{\text{WAIT}}$	Floating
$\overline{\text{BLAST}}$	Floating
$\text{DT}/\overline{\text{R}}$	Floating
$\overline{\text{DEN}}$	Floating
$\overline{\text{LOCK}}$	Floating
BREQ	Driven (high or low)
$\text{D}/\overline{\text{C}}$	Floating
$\overline{\text{DMA}}$	Floating
$\overline{\text{SUP}}$	Floating
$\overline{\text{FAIL}}$	Driven high (Inactive)
$\overline{\text{DACK}}3$	Driven high (Inactive)
$\overline{\text{DACK}}2$	Driven high (Inactive)
$\overline{\text{DACK}}1$	Driven high (Inactive)
$\overline{\text{DACK}}0$	Driven high (Inactive)
$\overline{\text{EOP}}/\overline{\text{TC}}3$	Driven if output
$\overline{\text{EOP}}/\overline{\text{TC}}2$	Driven if output
$\overline{\text{EOP}}/\overline{\text{TC}}1$	Driven if output
$\overline{\text{EOP}}/\overline{\text{TC}}0$	Driven if output

6.0 BUS WAVEFORMS

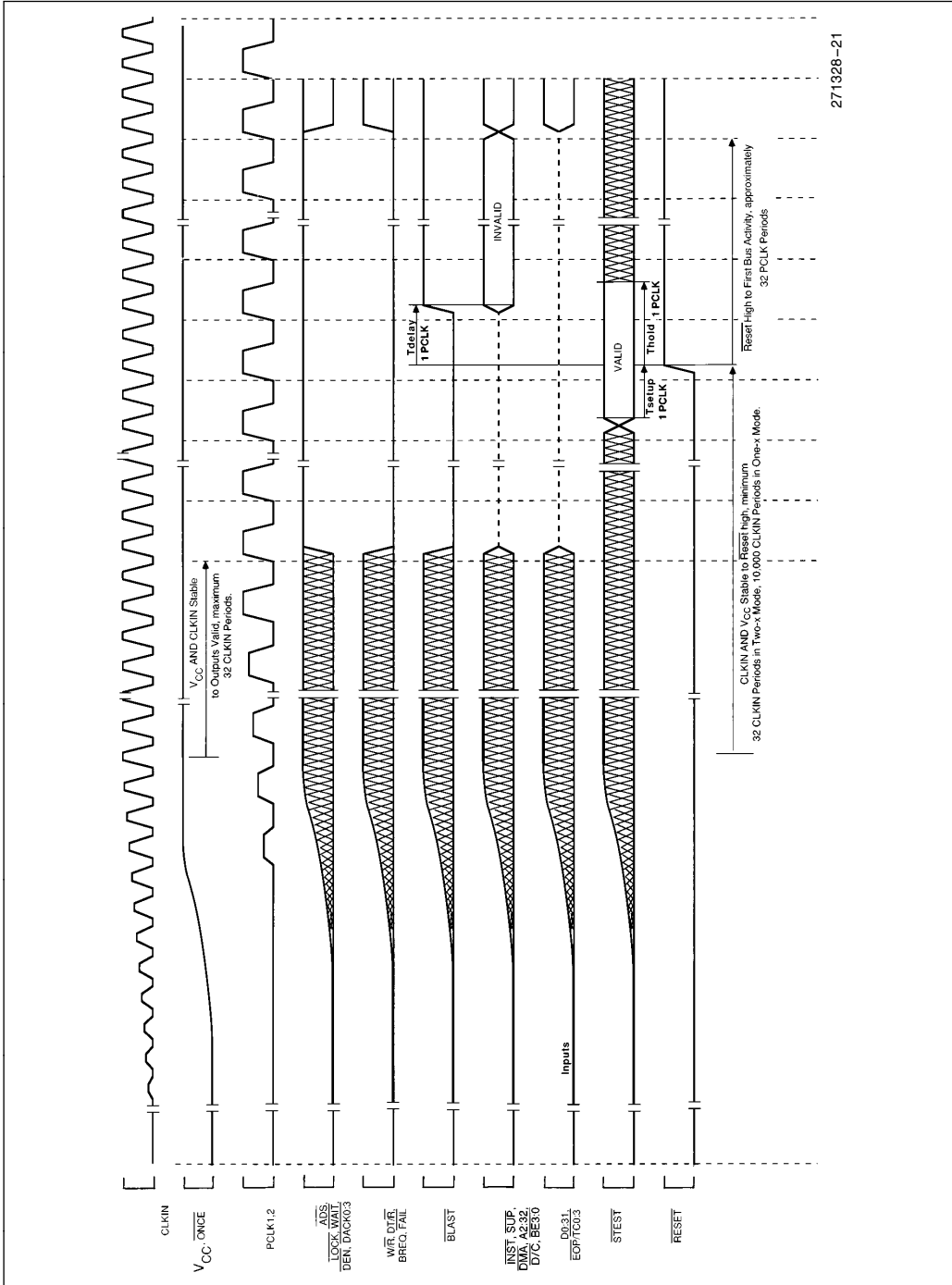

271328-21

Figure 19. Cold Reset Waveform

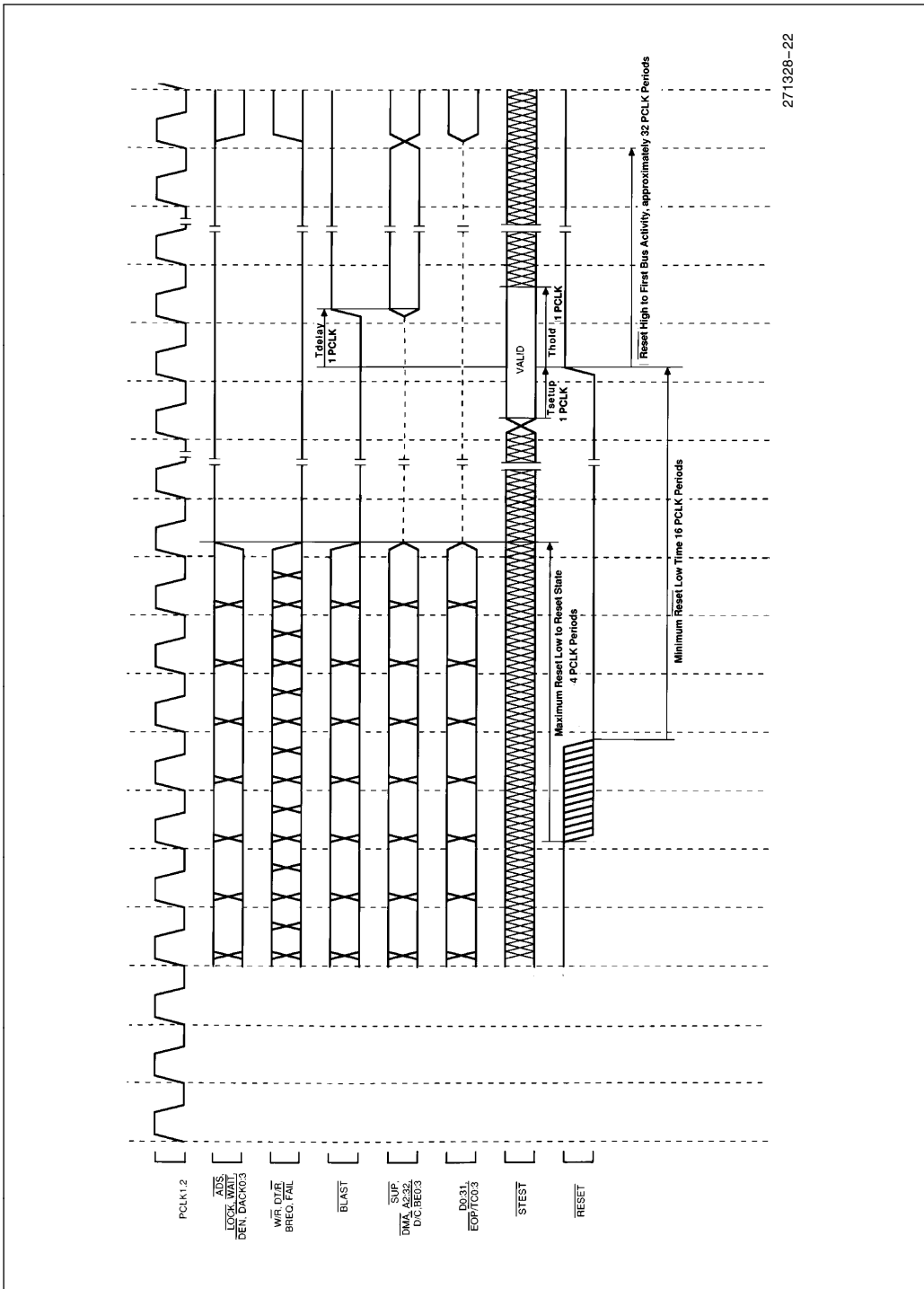

271328-22

Figure 20. Warm Reset Waveform

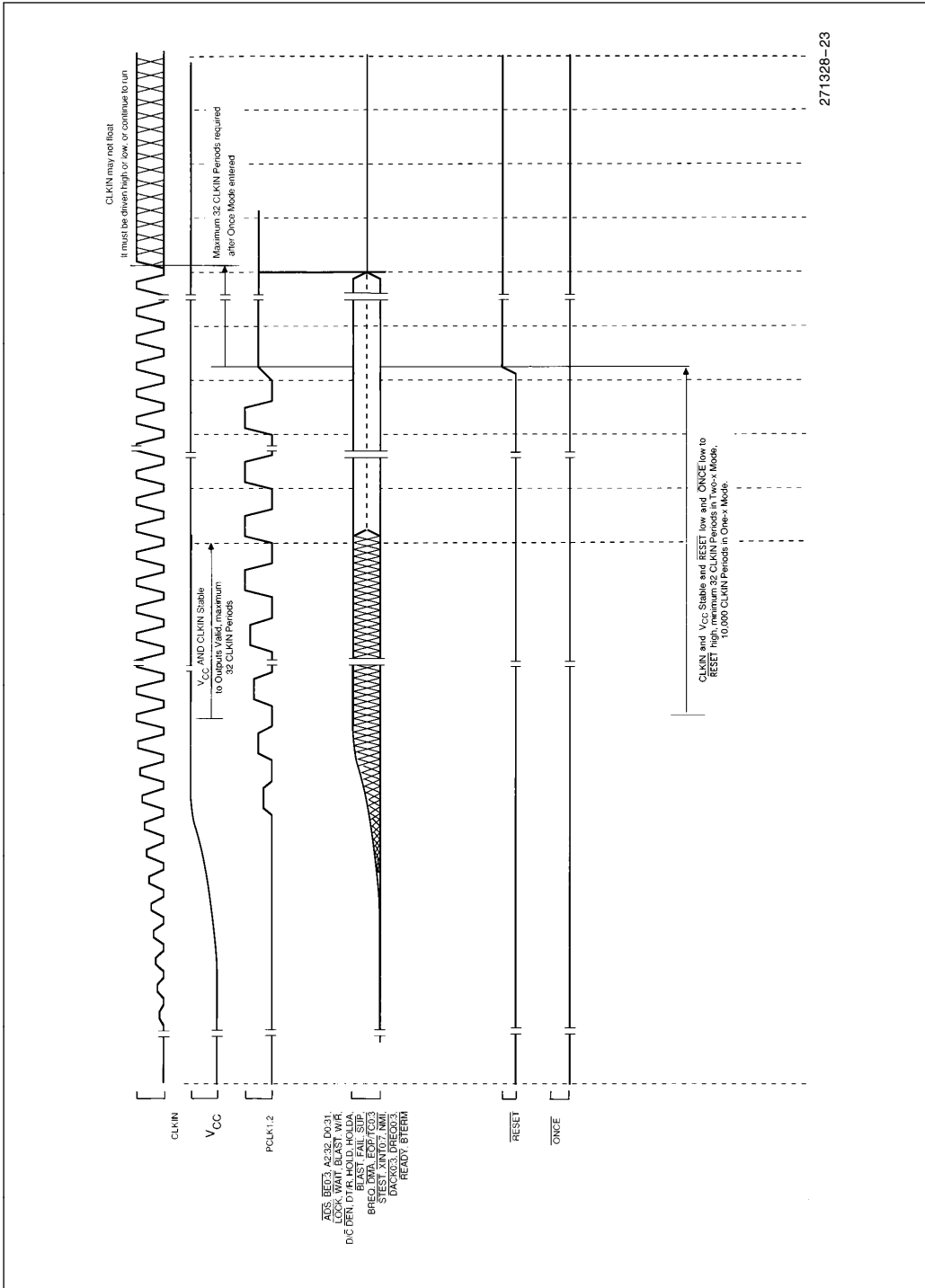

Figure 21. Entering the ONCE State

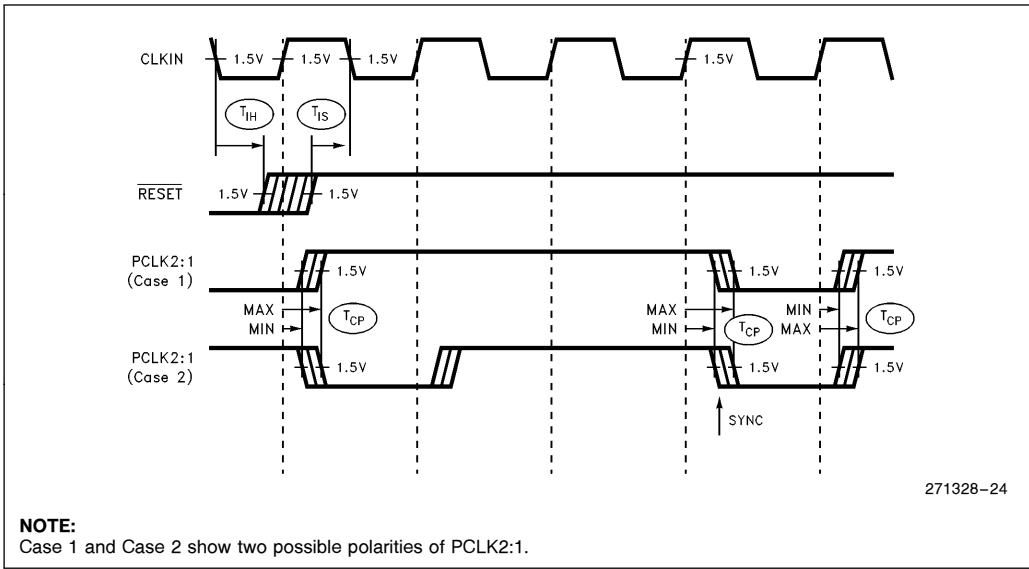

Figure 22a. Clock Synchronization in the 2x Clock Mode

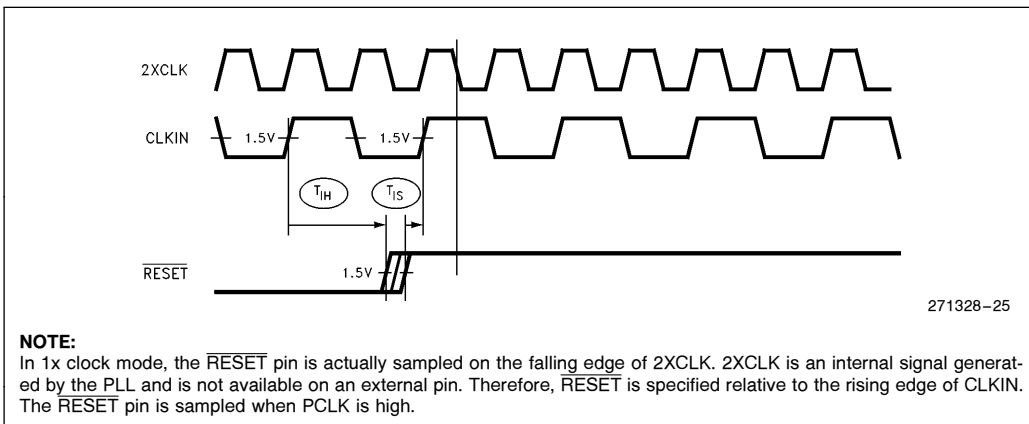

Figure 22b. Clock Synchronization in the 1x Clock Mode

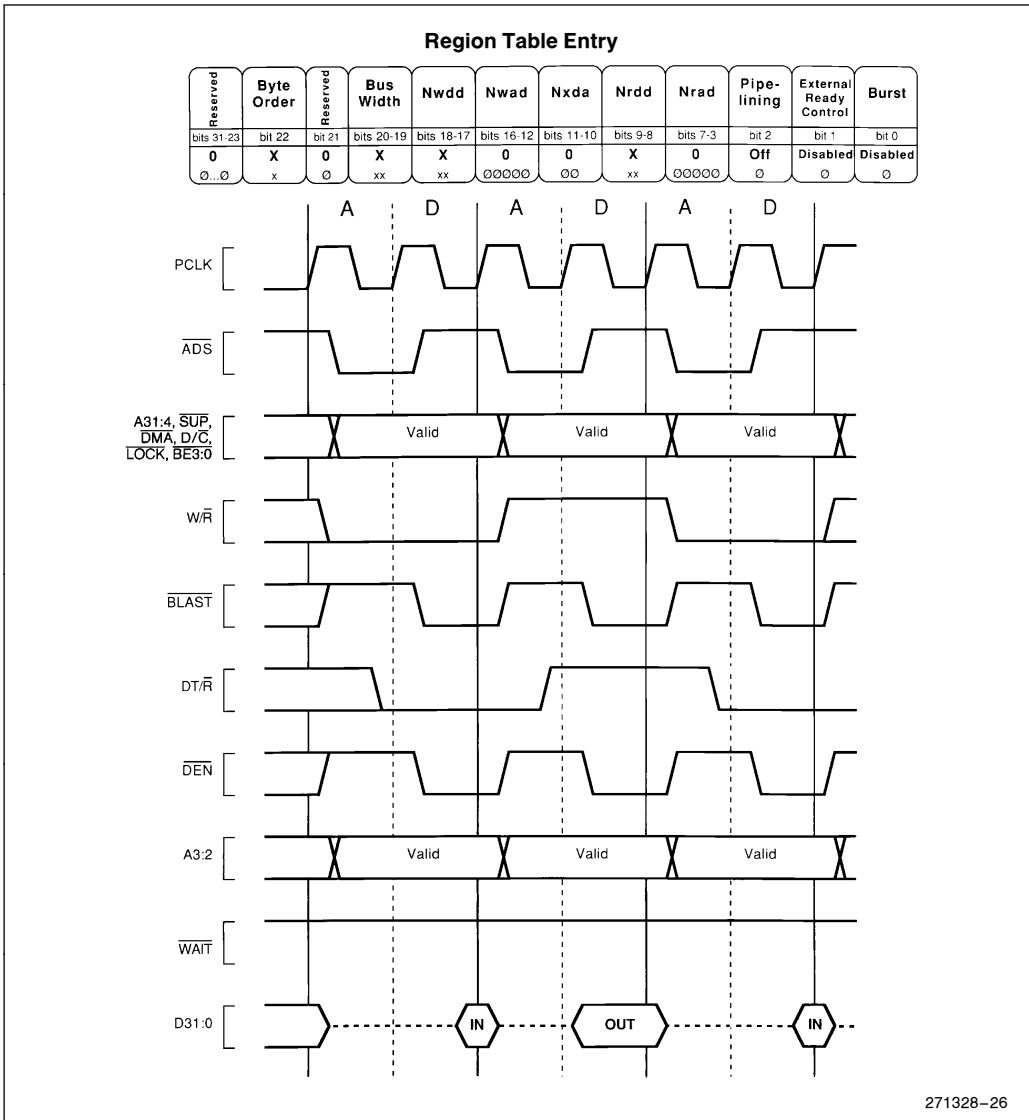

Figure 23. Non-Burst, Non-Pipelined Requests without Wait States

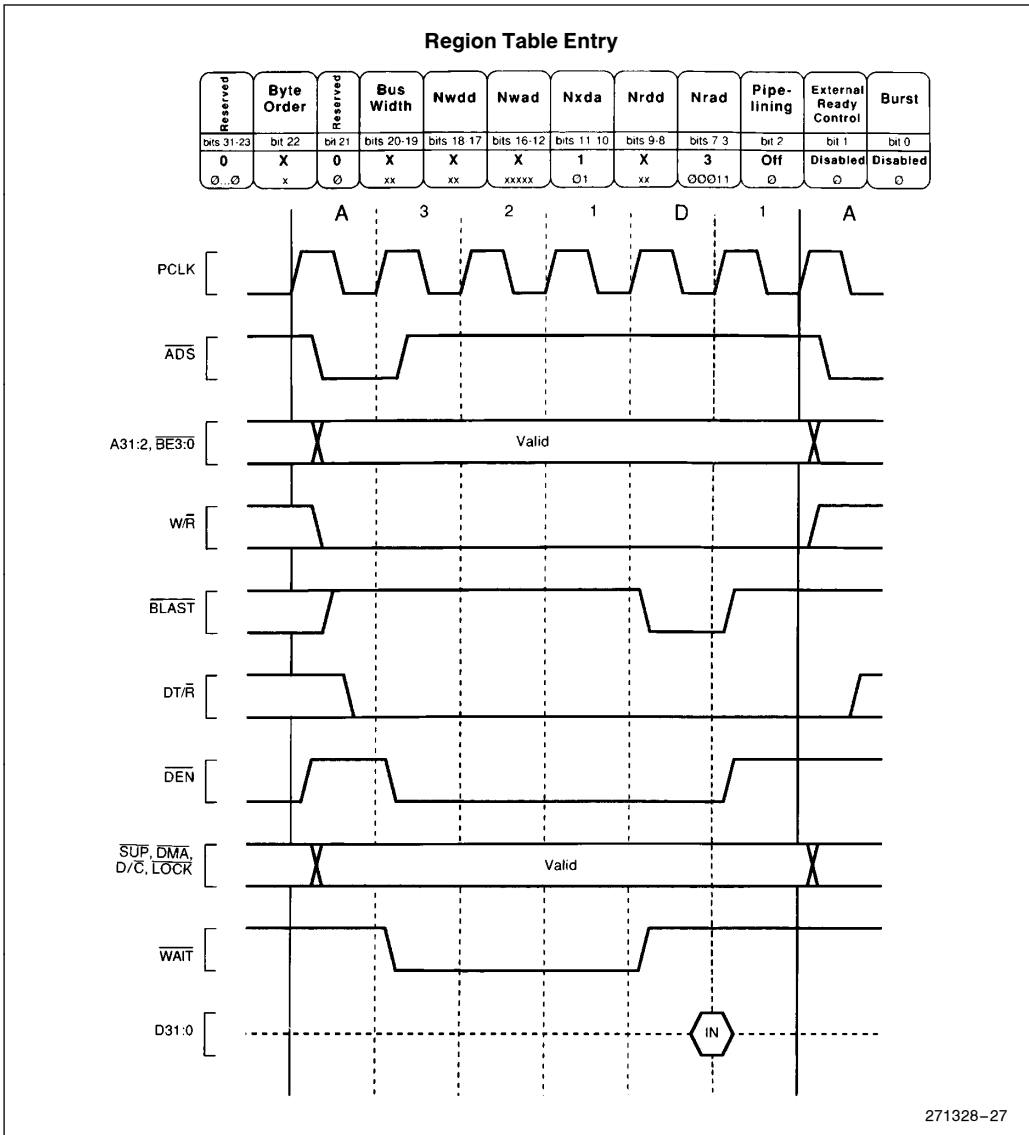

Figure 24. Non-Burst, Non-Pipelined Read Request with Wait States

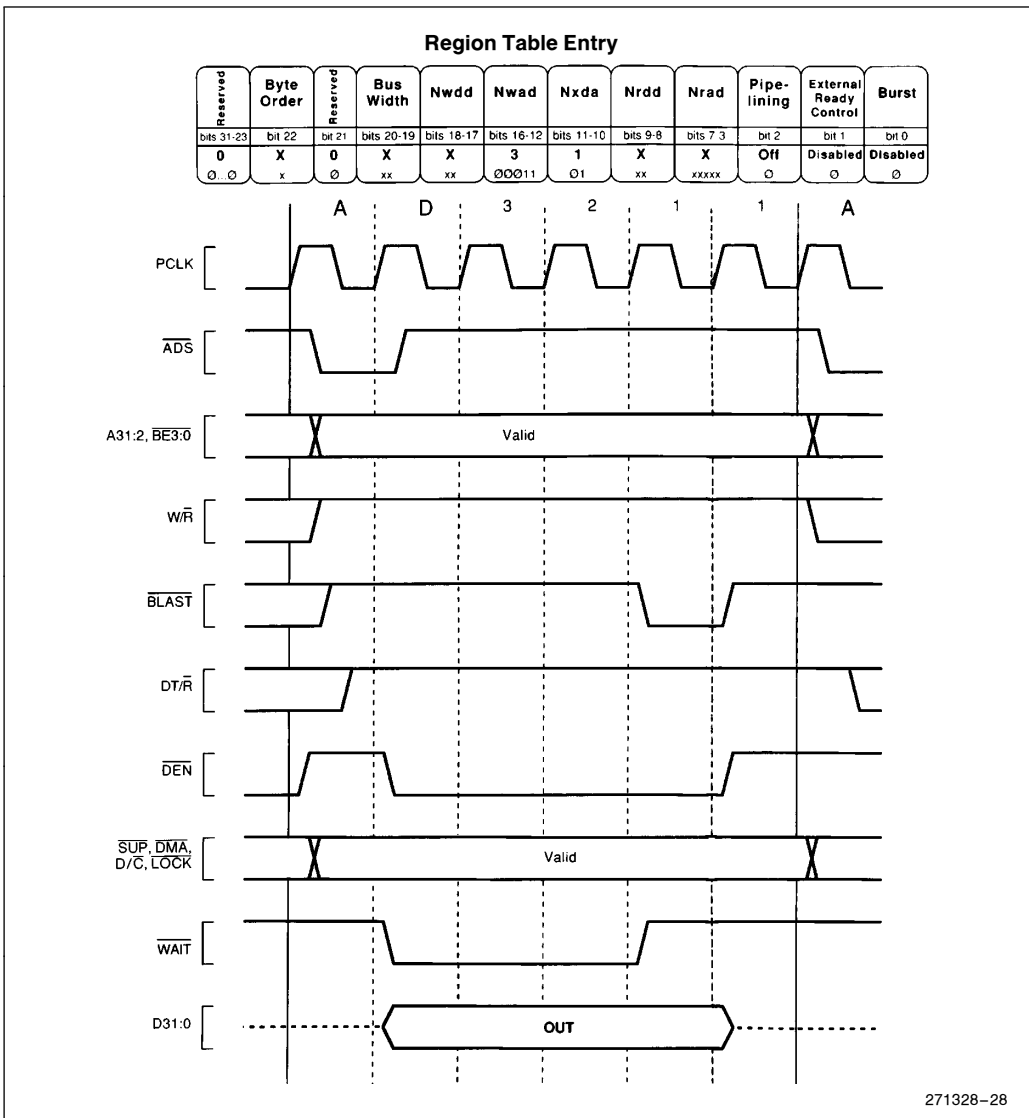

Figure 25. Non-Burst, Non-Pipelined Write Request with Wait States

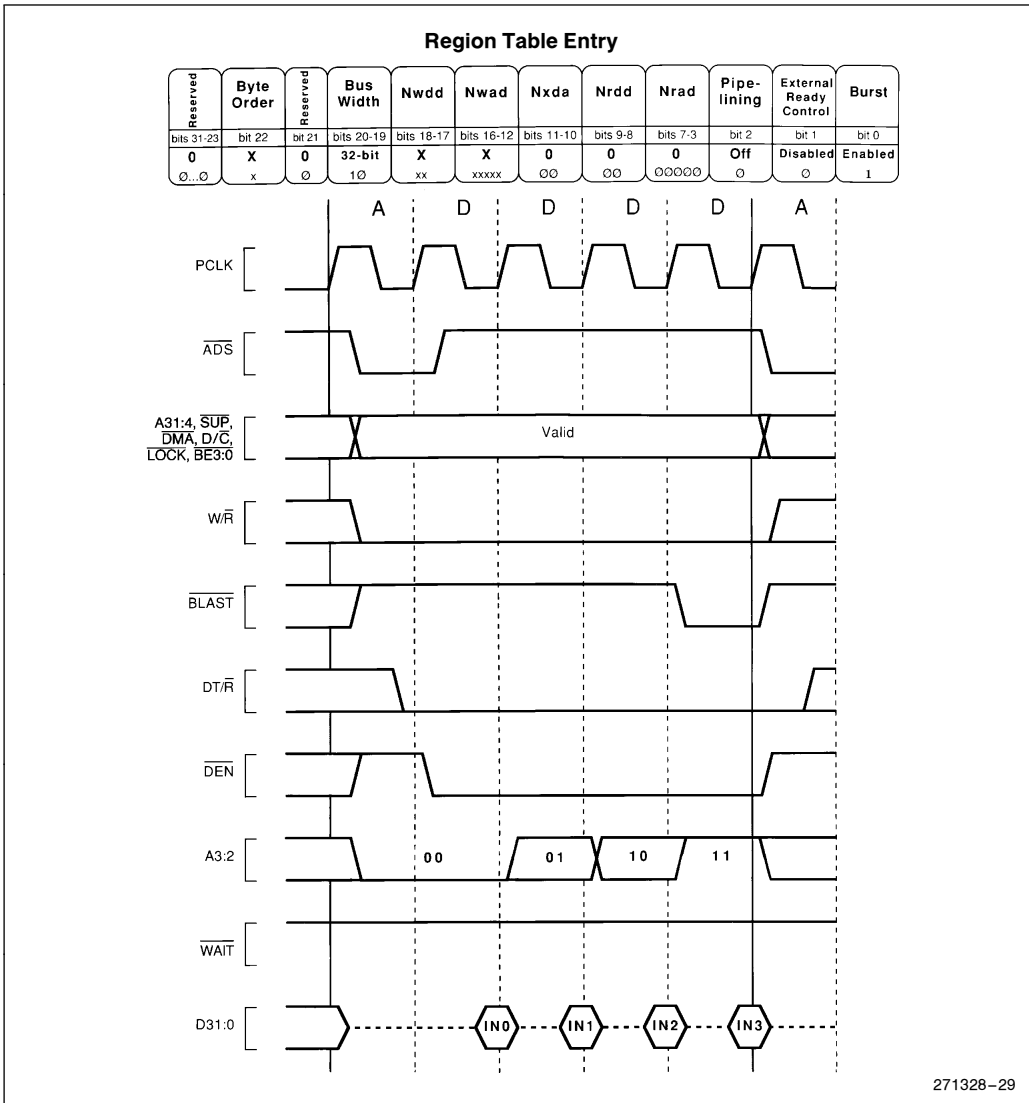

Figure 26. Burst, Non-Pipelined Read Request without Wait States, 32-Bit Bus

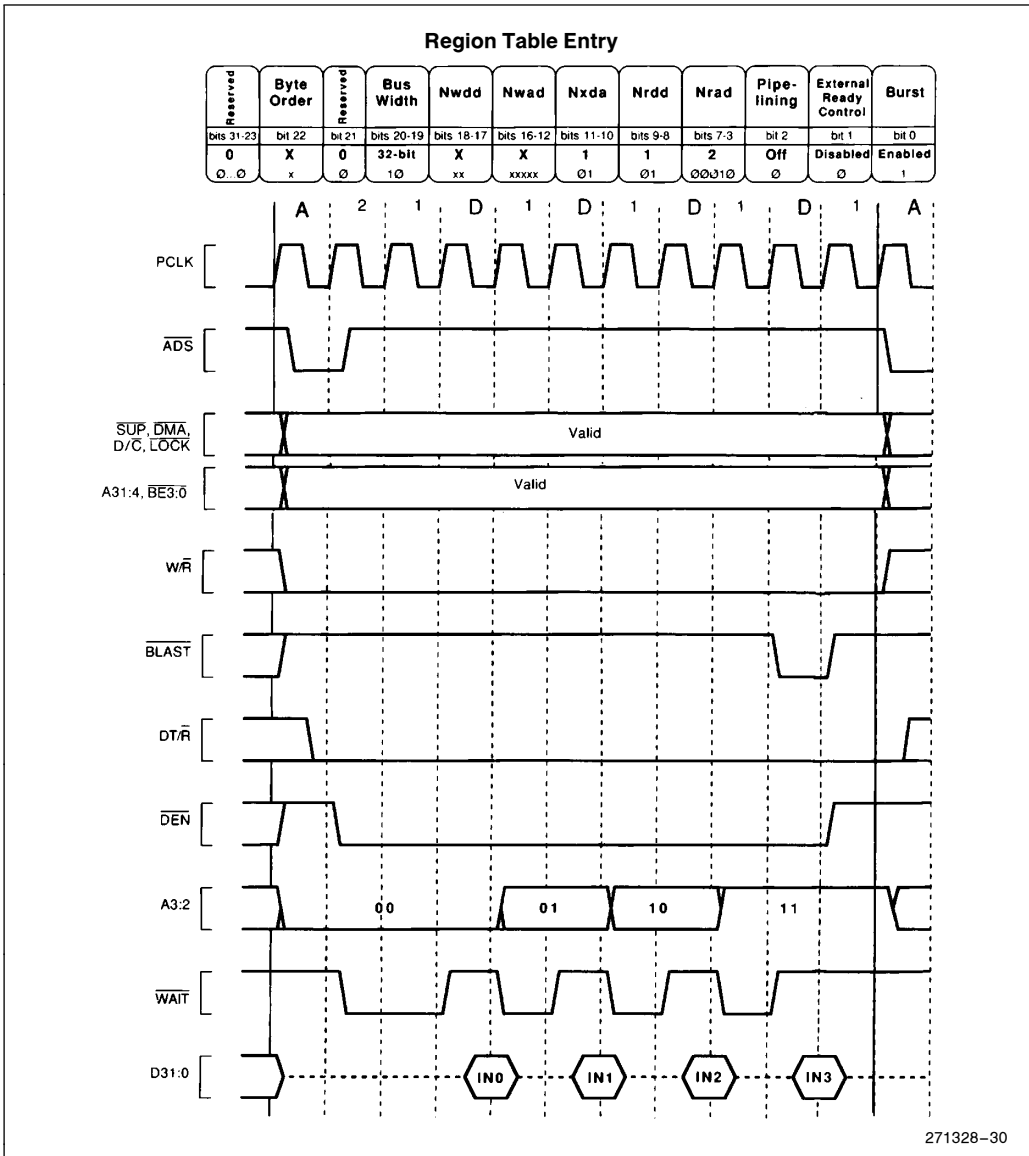

Figure 27. Burst, Non-Pipelined Read Request with Wait States, 32-Bit Bus

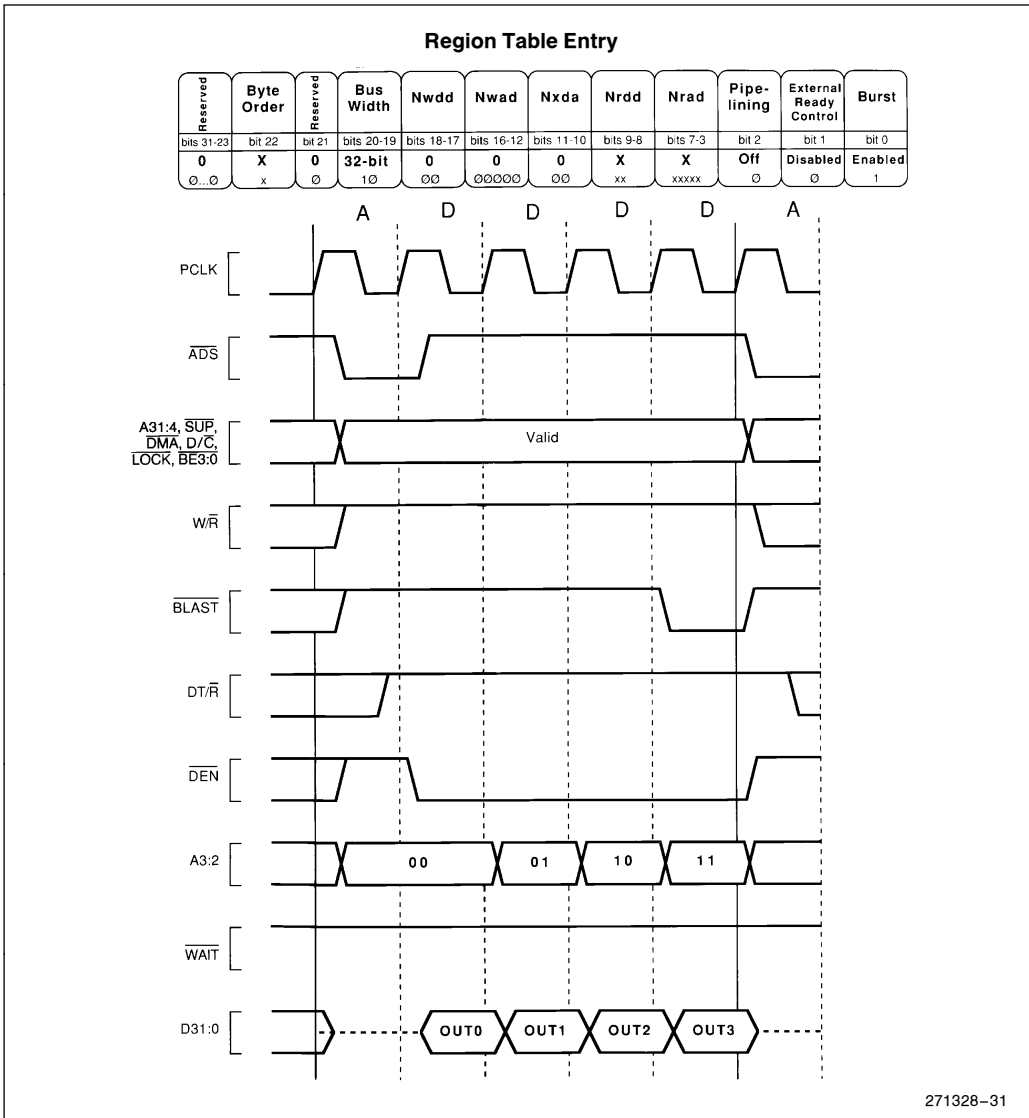

Figure 28. Burst, Non-Pipelined Write Request without Wait States, 32-Bit Bus

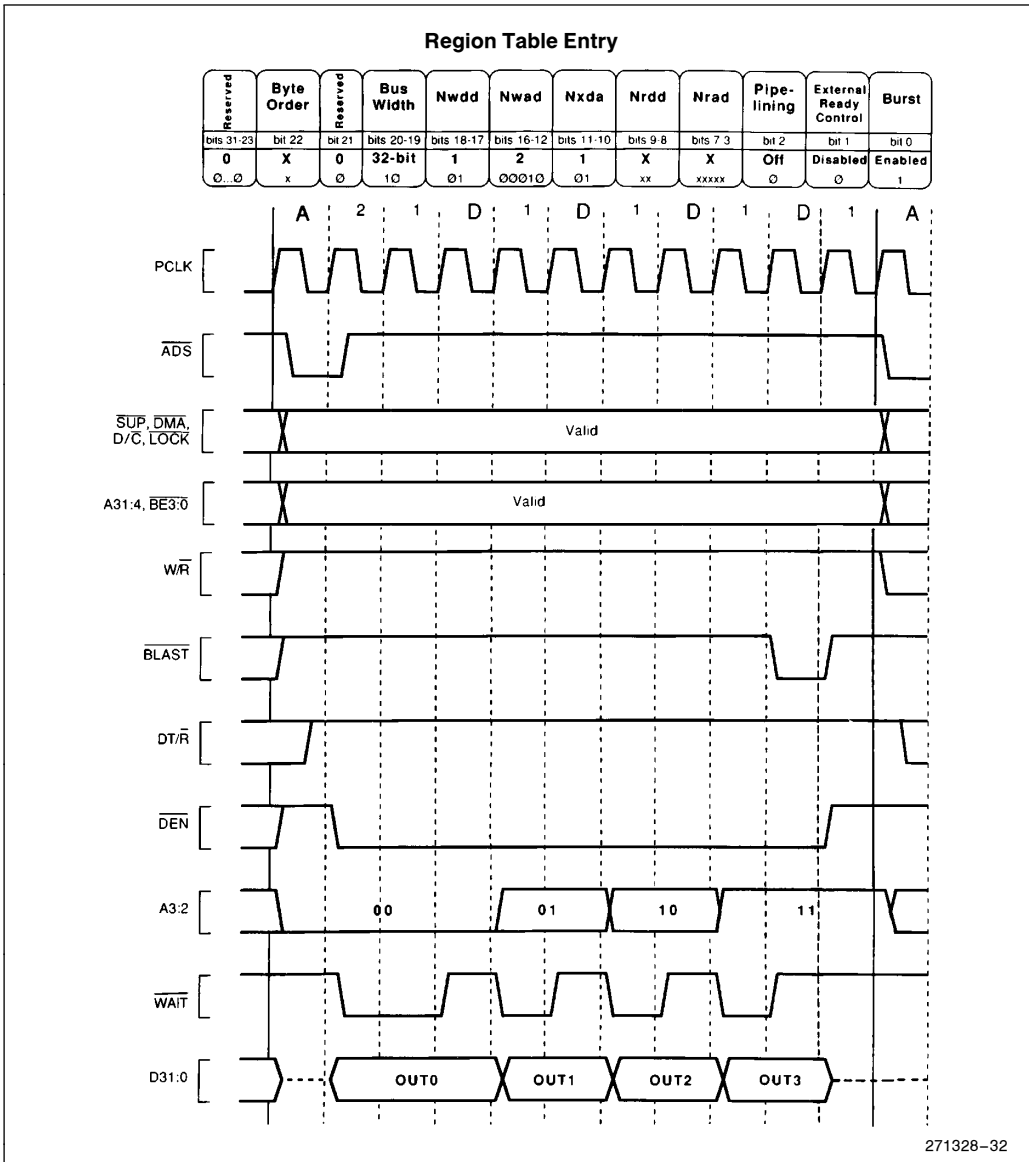

Figure 29. Burst, Non-Pipelined Write Request with Wait States, 32-Bit Bus

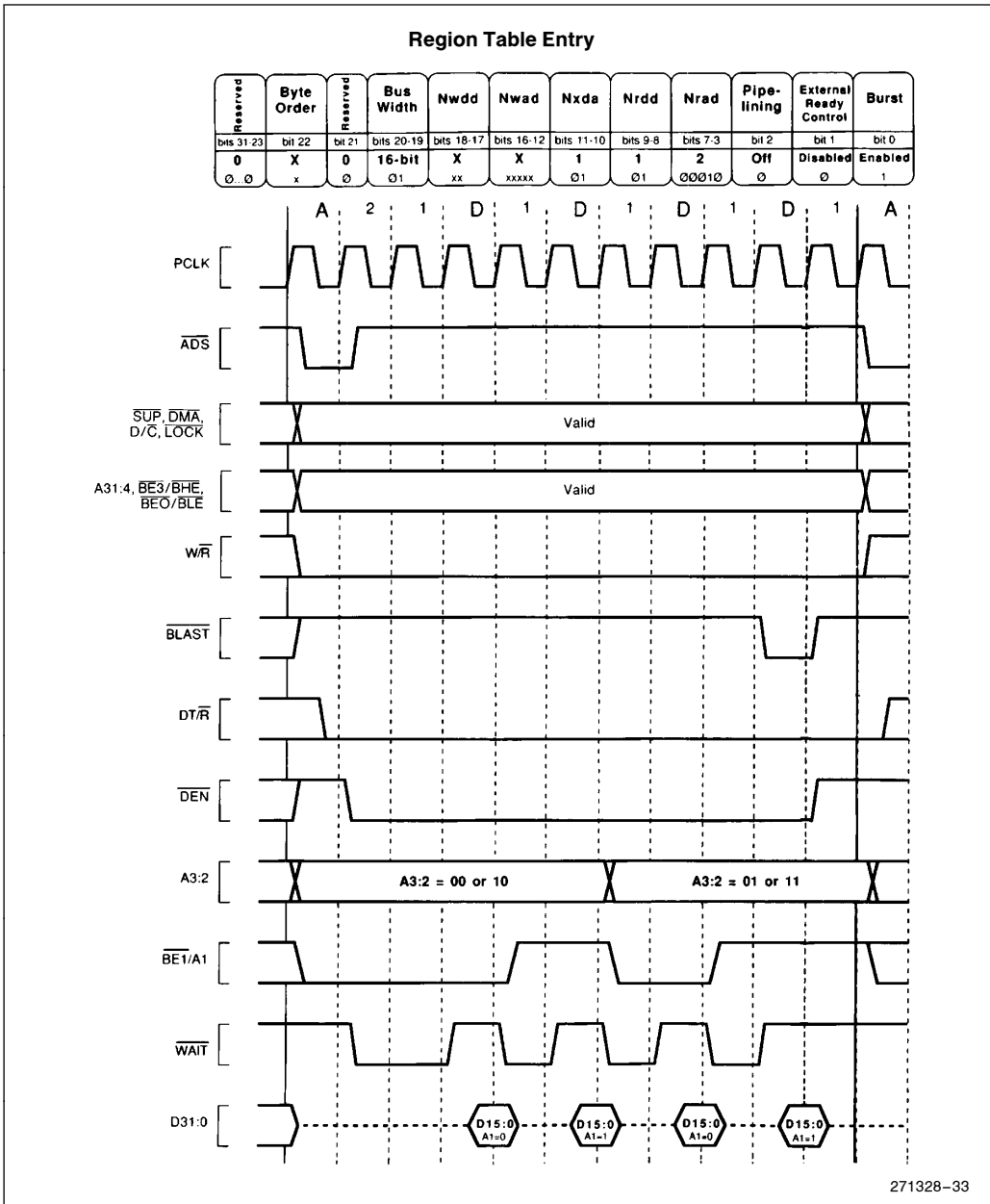

Figure 30. Burst, Non-Pipelined Read Request with Wait States, 16-Bit Bus

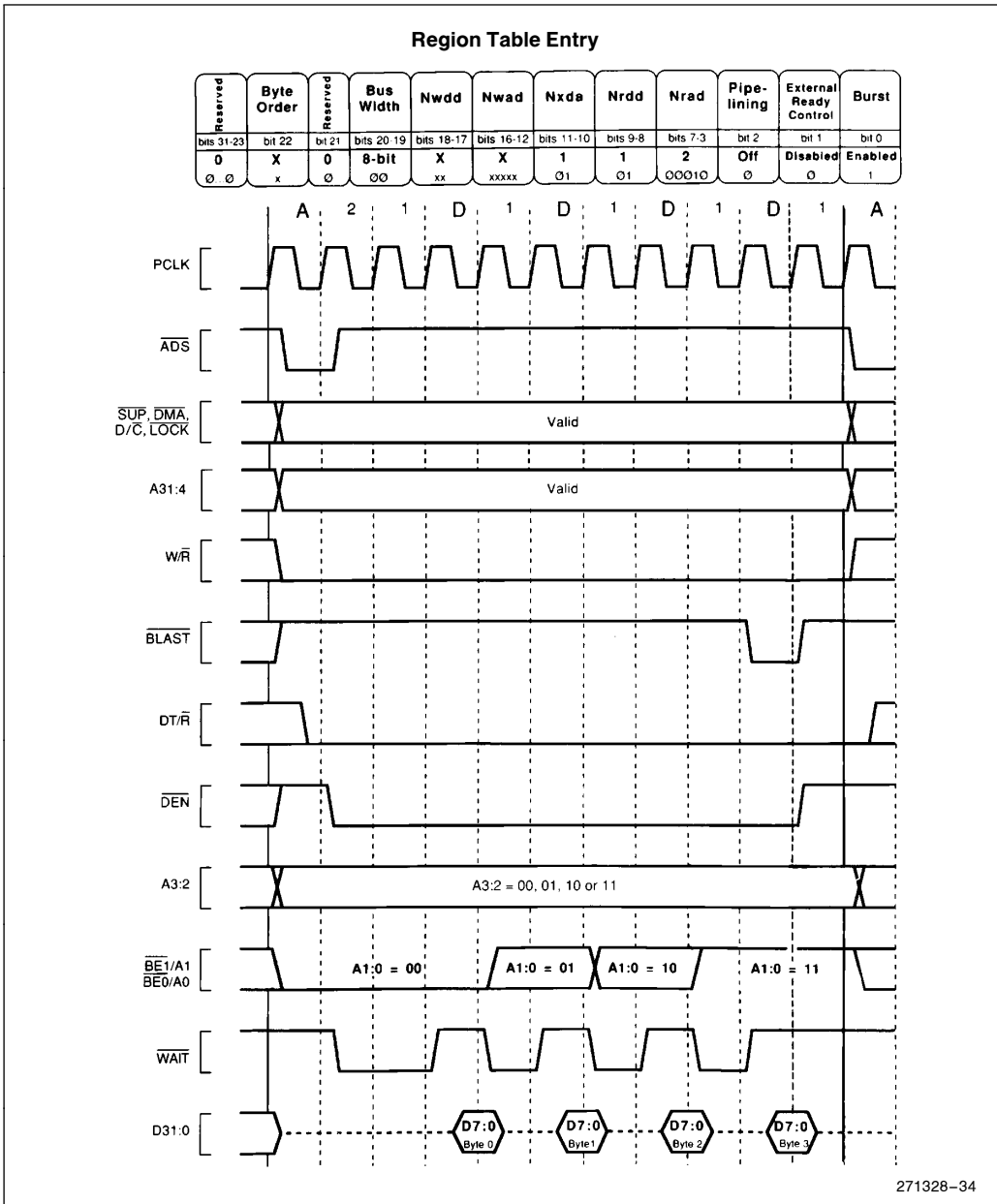

Figure 31. Burst, Non-Pipelined Read Request with Wait States, 8-Bit Bus

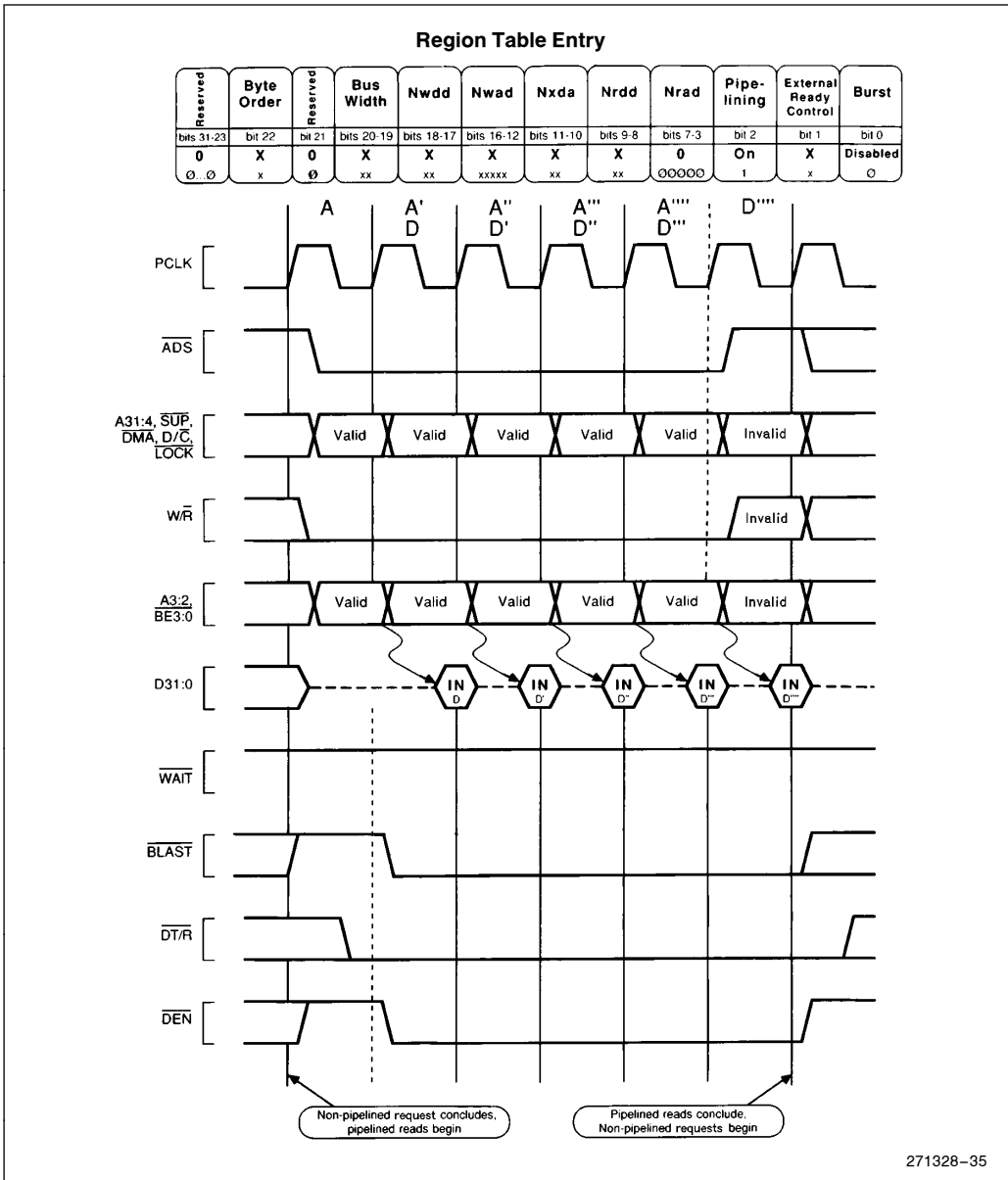

Figure 32. Non-Burst, Pipelined Read Request without Wait States, 32-Bit Bus

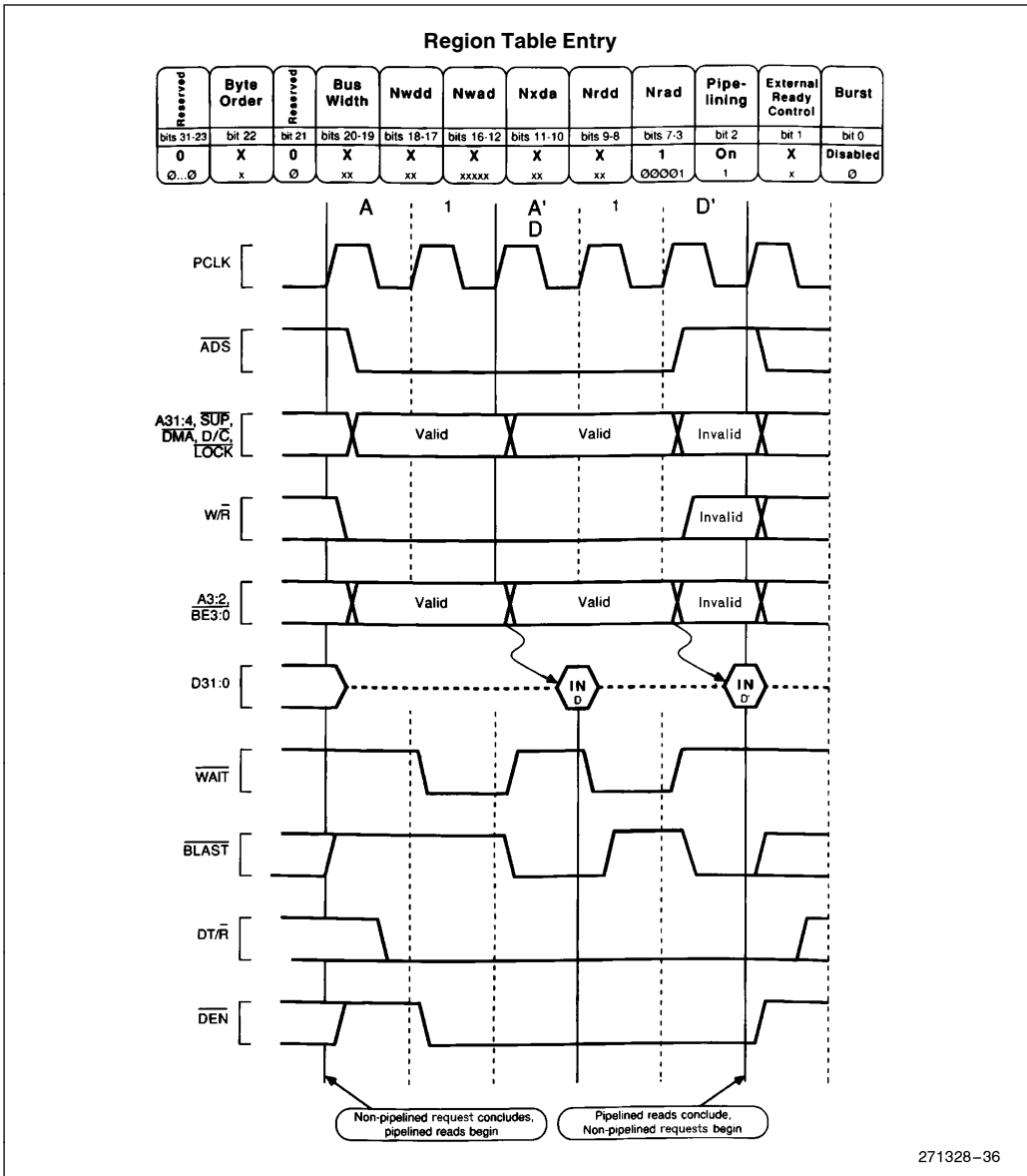

Figure 33. Non-Burst, Pipelined Read Request with Wait States, 32-Bit Bus

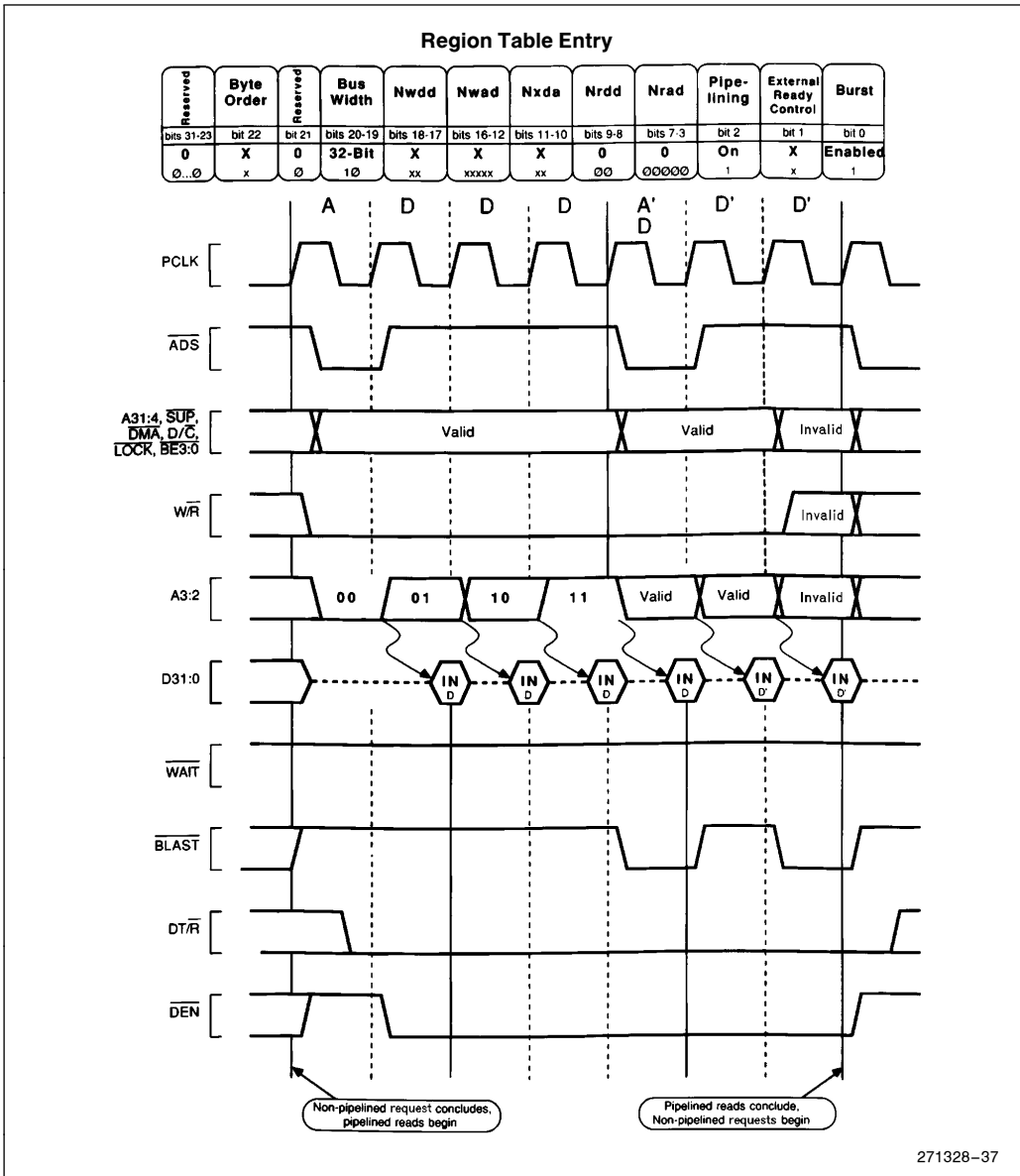

Figure 34. Burst, Pipelined Read Request without Wait States, 32-Bit Bus

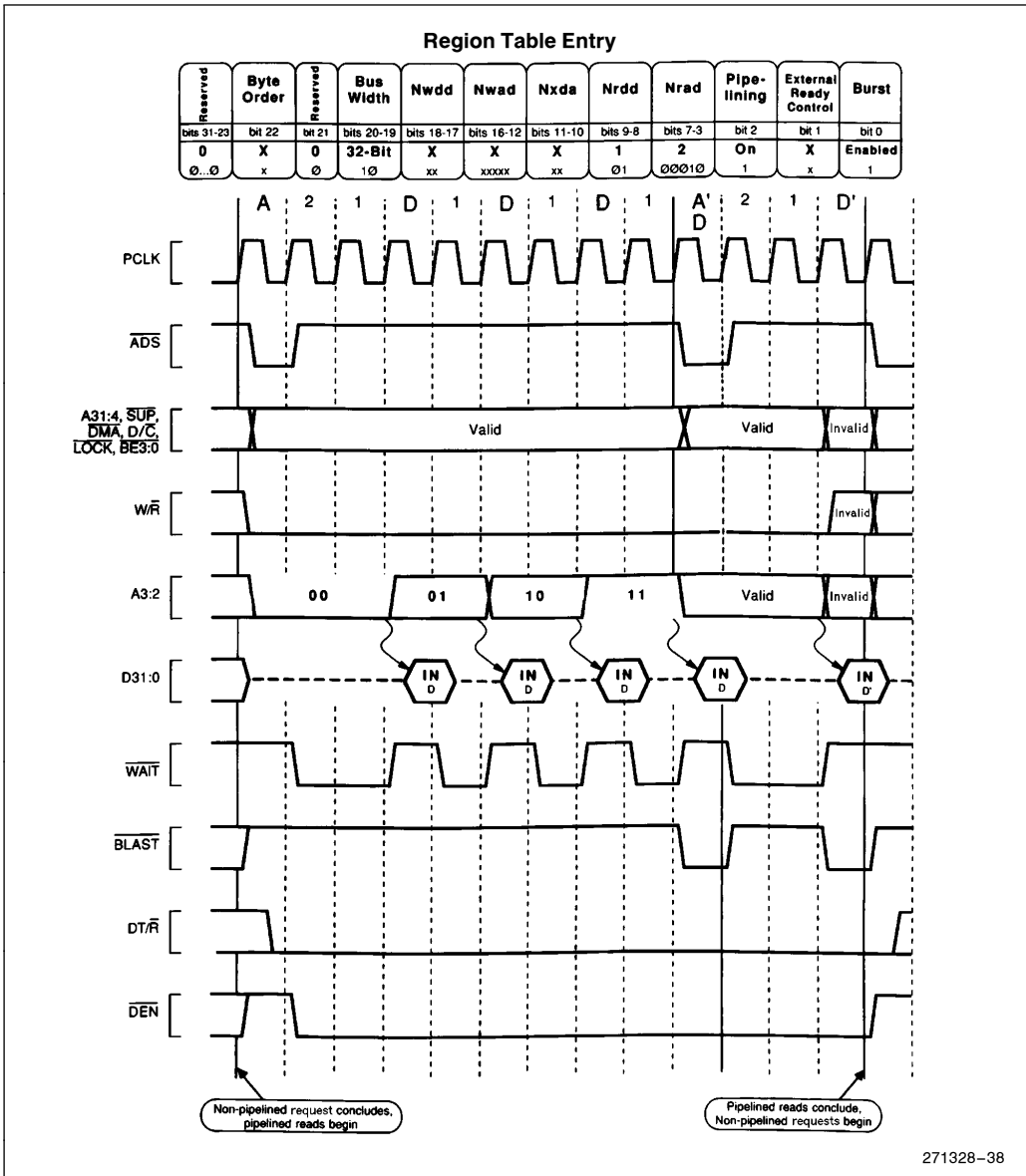

Figure 35. Burst, Pipelined Read Requests with Wait States, 32-Bit Bus

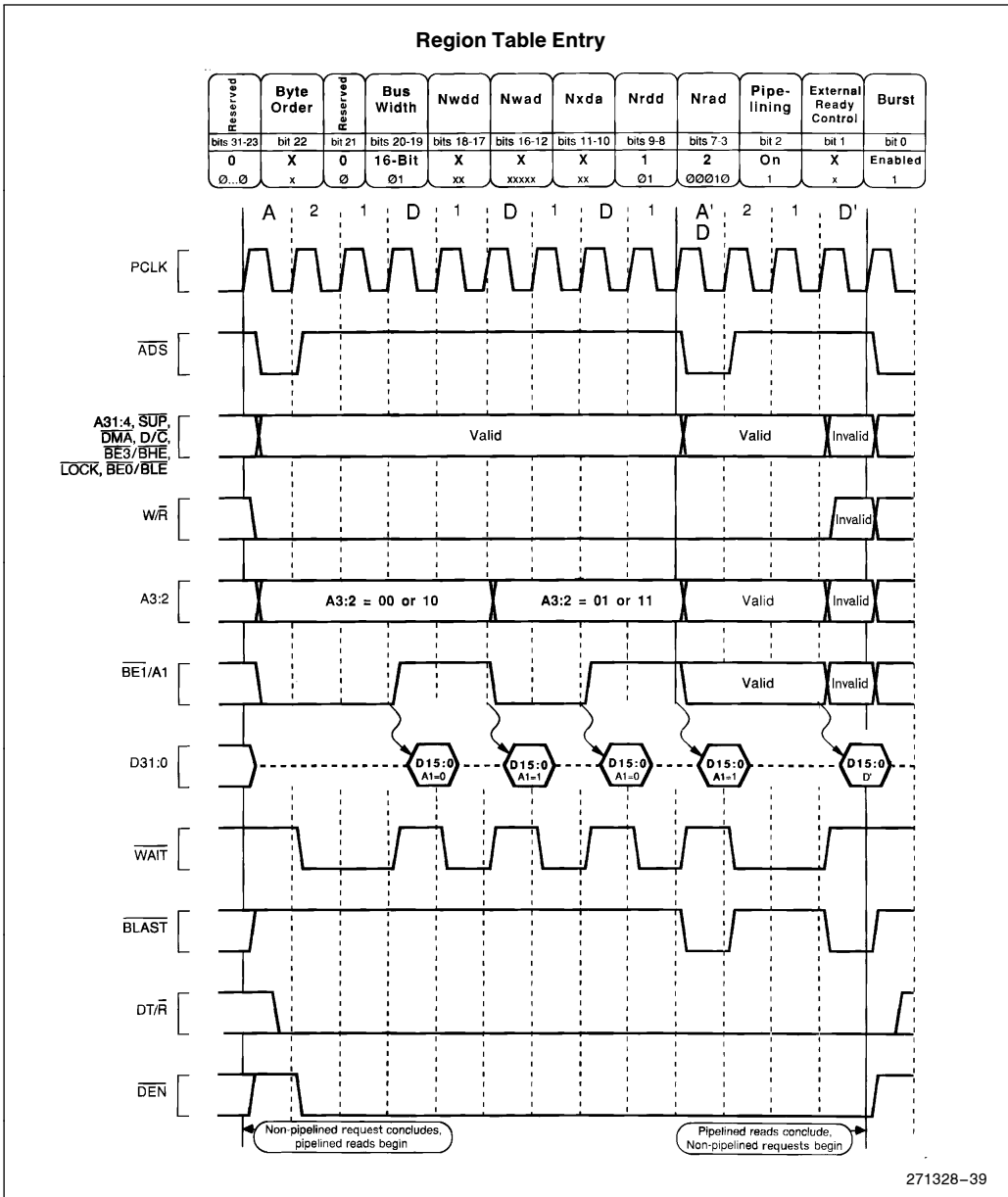

Figure 36. Burst, Pipelined Read Requests with Wait States, 16-Bit Bus

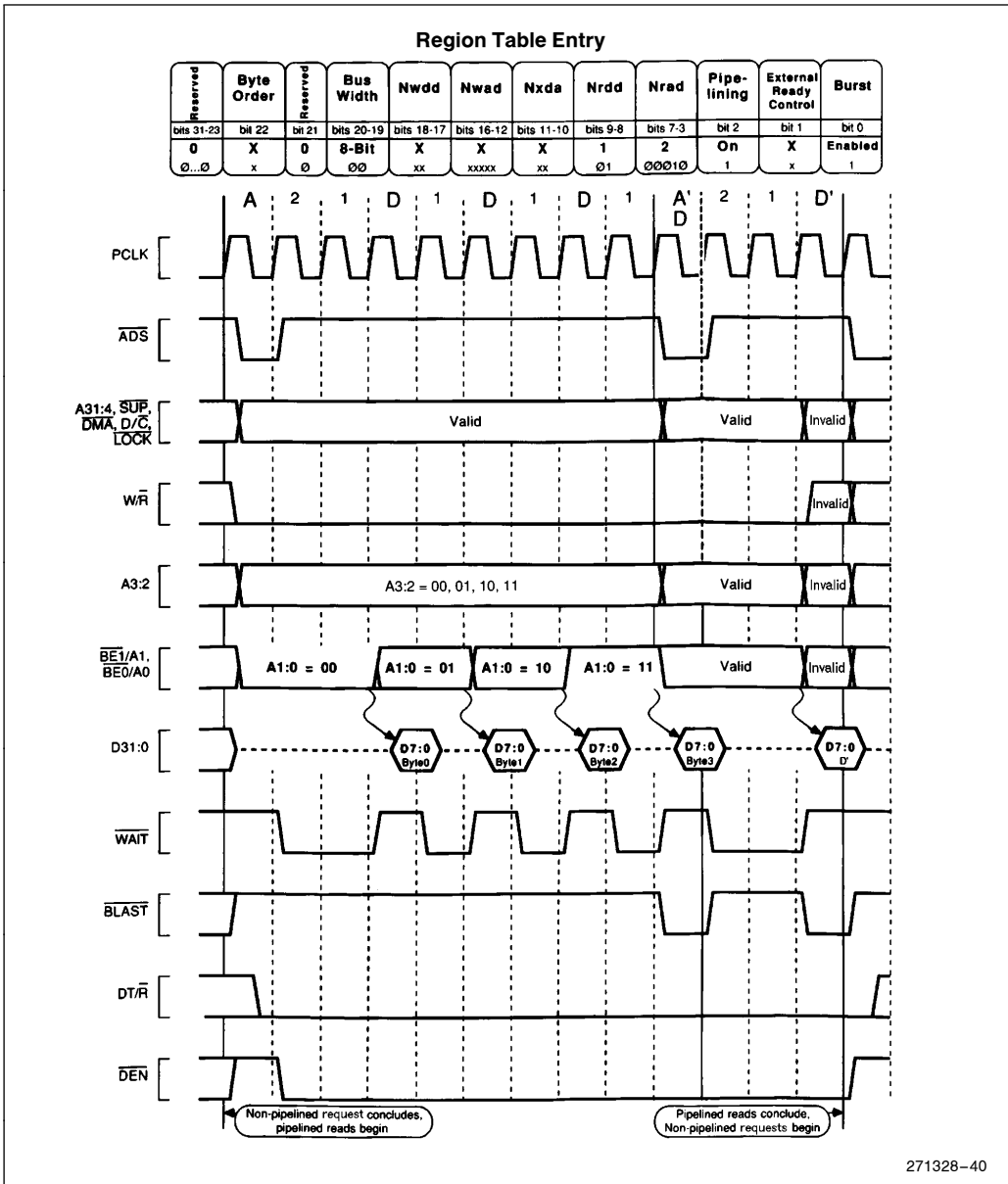

Figure 37. Burst, Pipelined Read Requests with Wait States, 8-Bit Bus

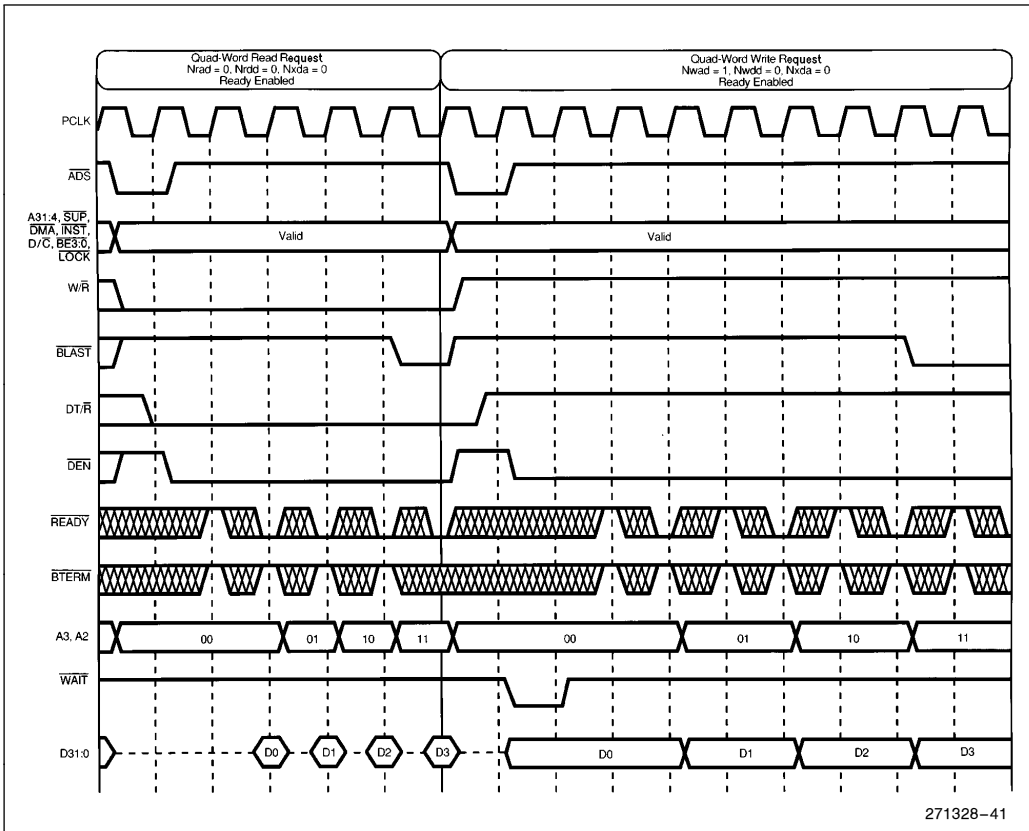

Figure 38. Using External READY

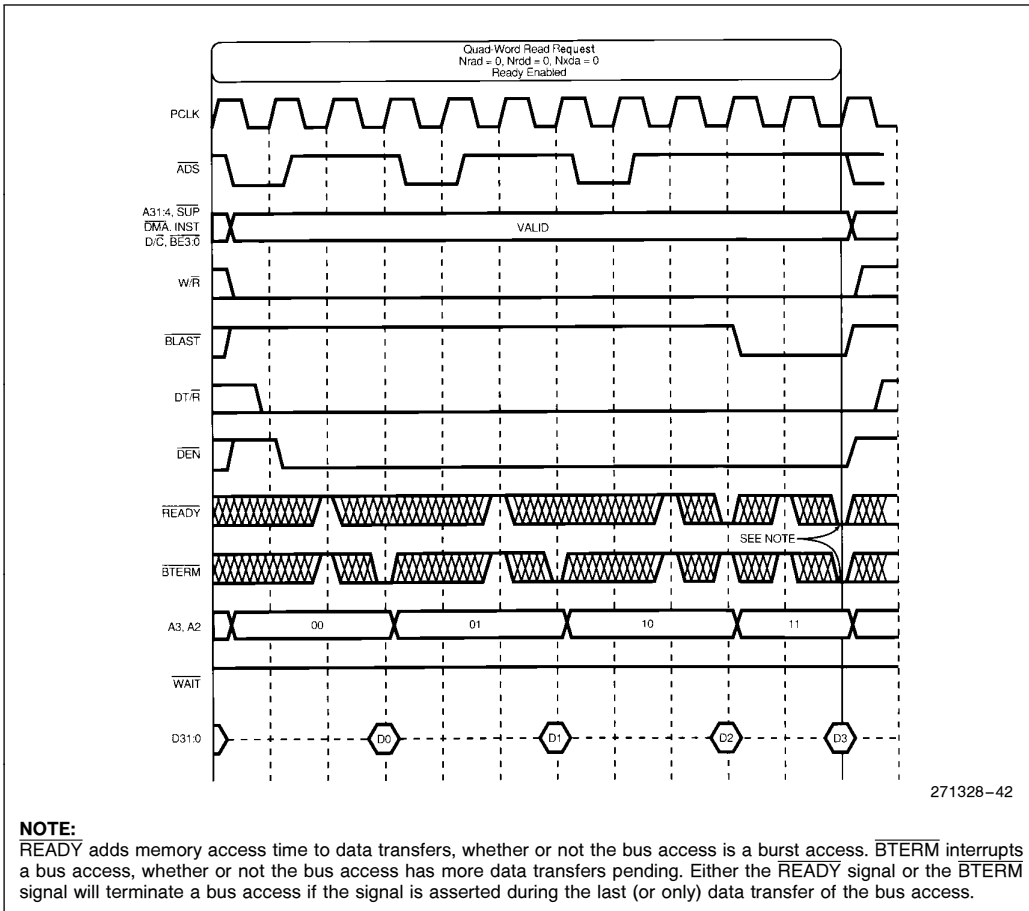

Figure 39. Terminating a Burst with BTERM

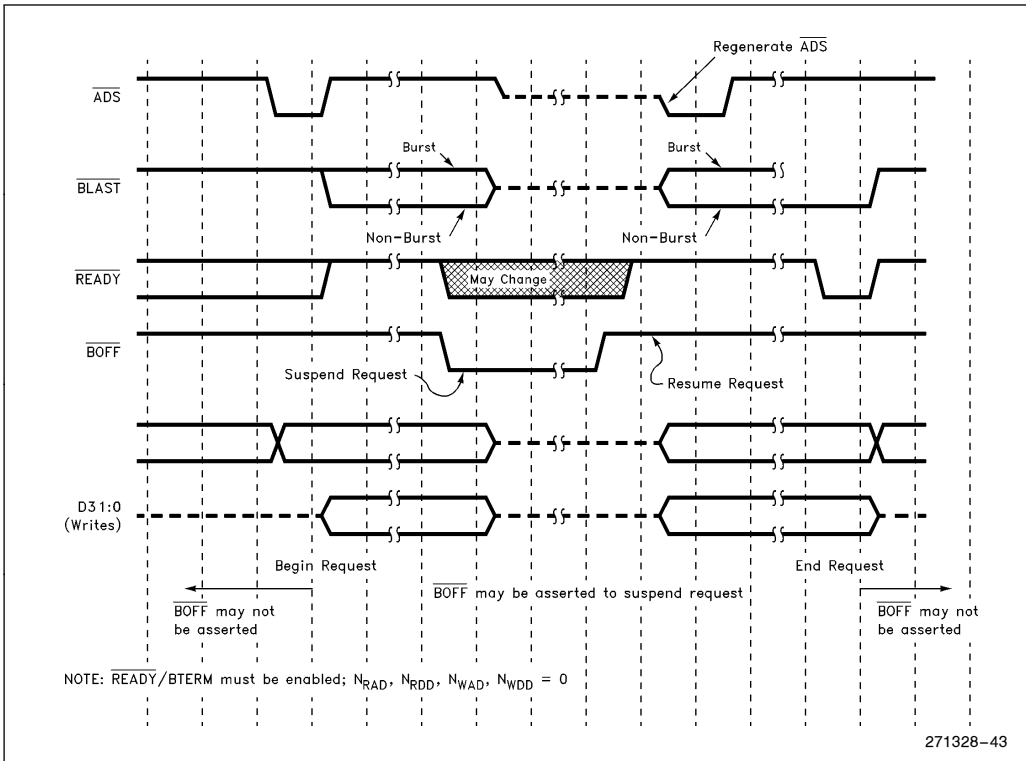

Figure 40. BOFF Functional Timing

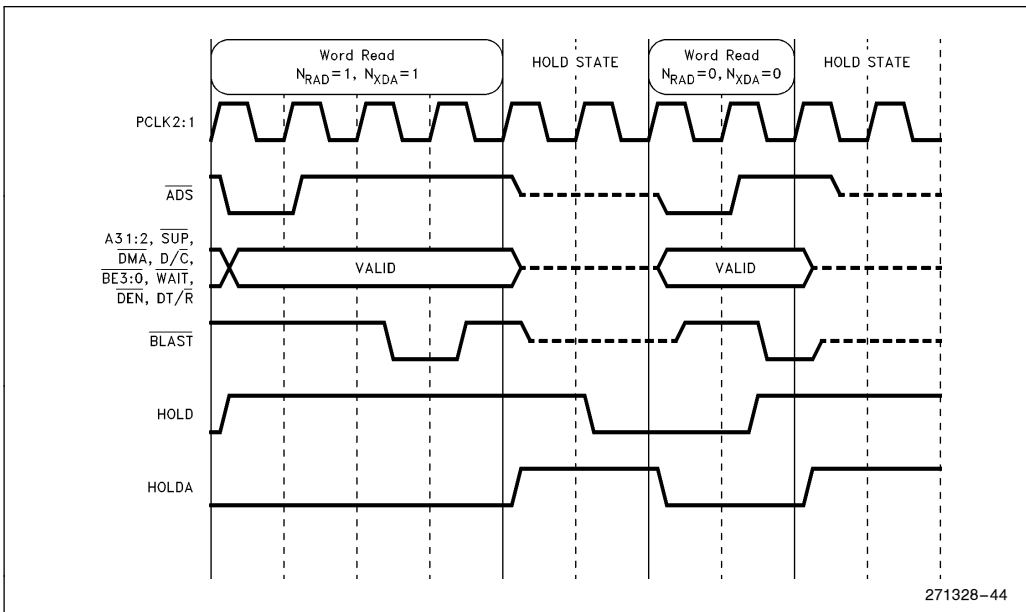

Figure 41. HOLD Functional Timing

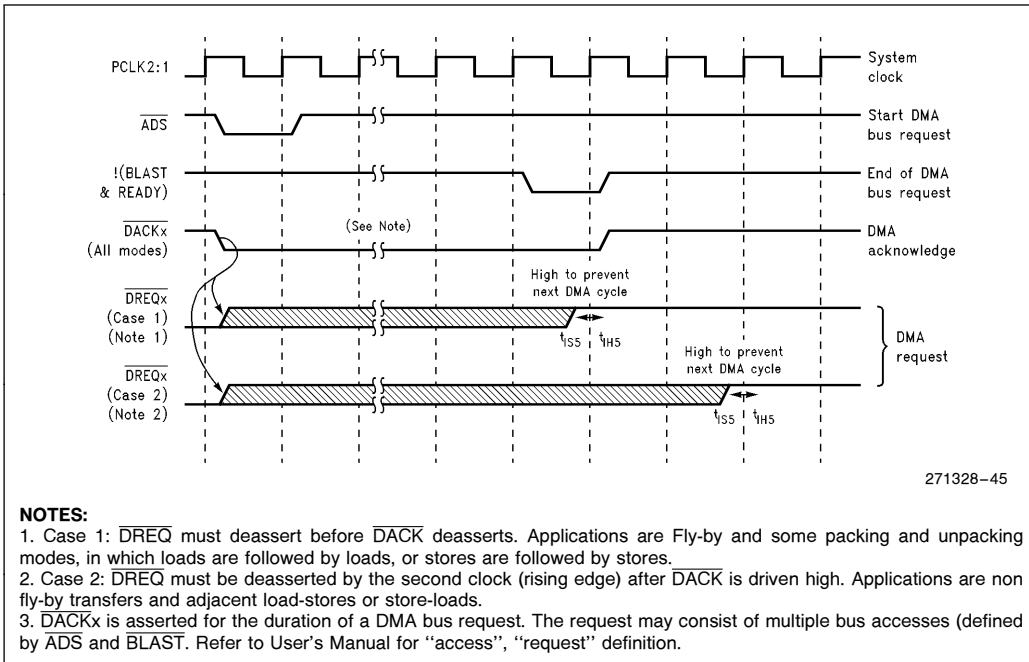

Figure 42. DREQ and DACK Functional Timing

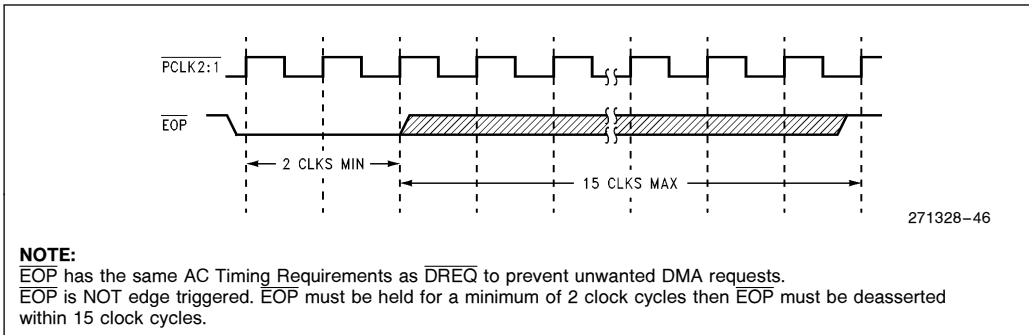

Figure 43. EOP Functional Timing

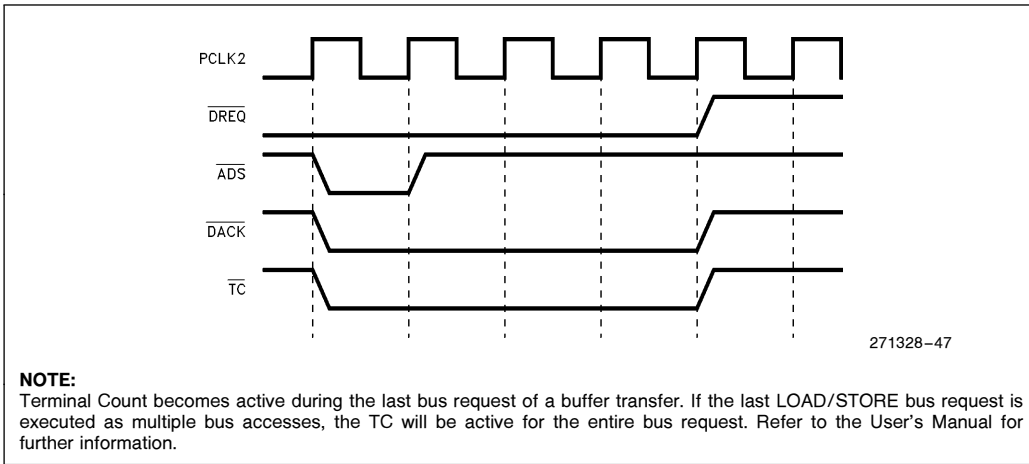

Figure 44. Terminal Count Functional Timing

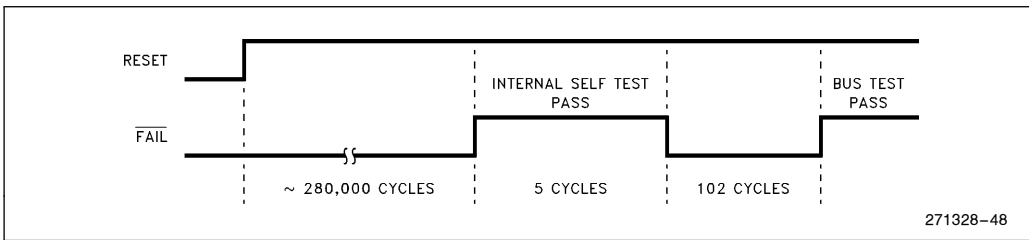

Figure 45. FAIL Functional Timing

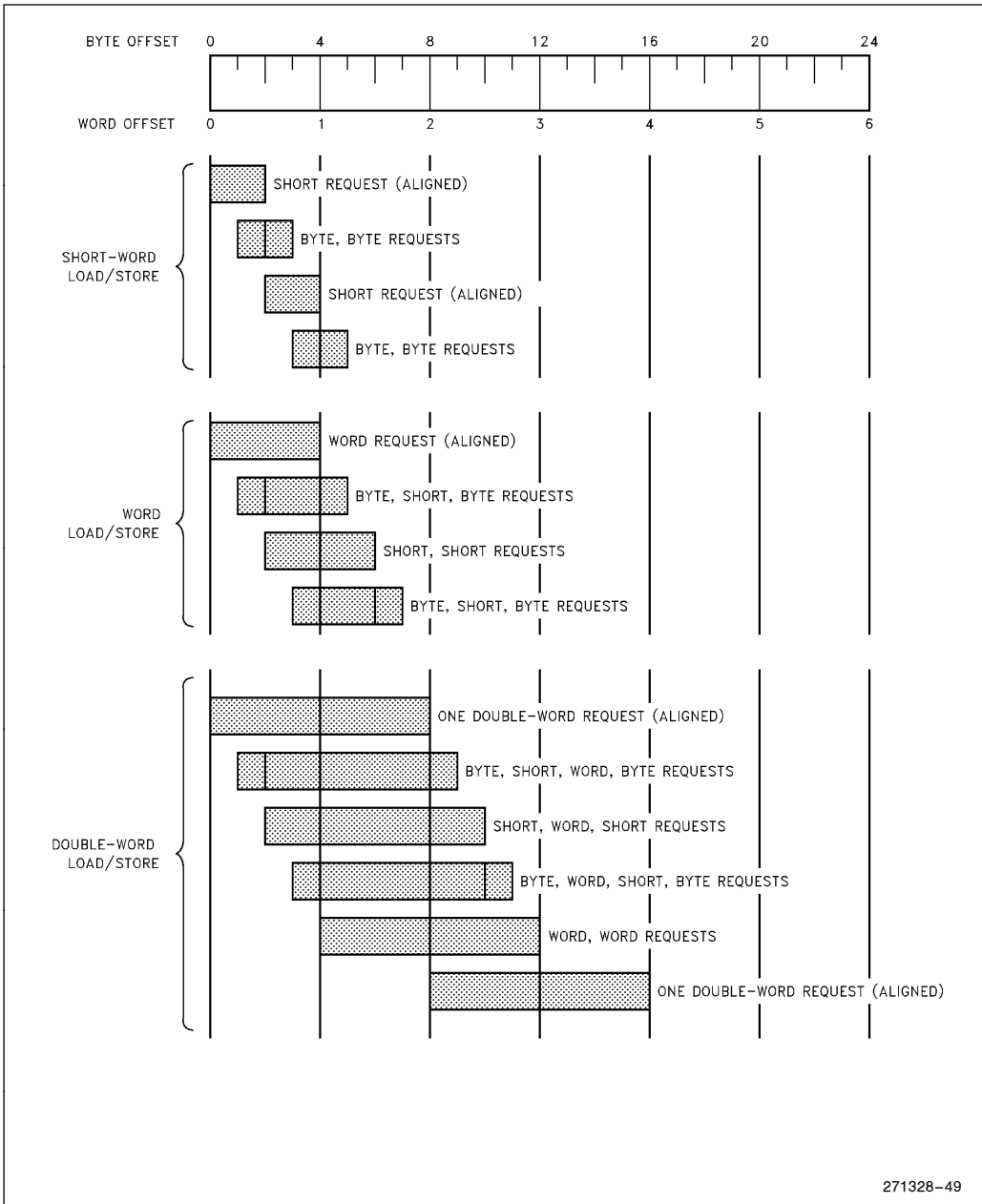

Figure 46. A Summary of Aligned and Unaligned Transfers for Little Endian Regions

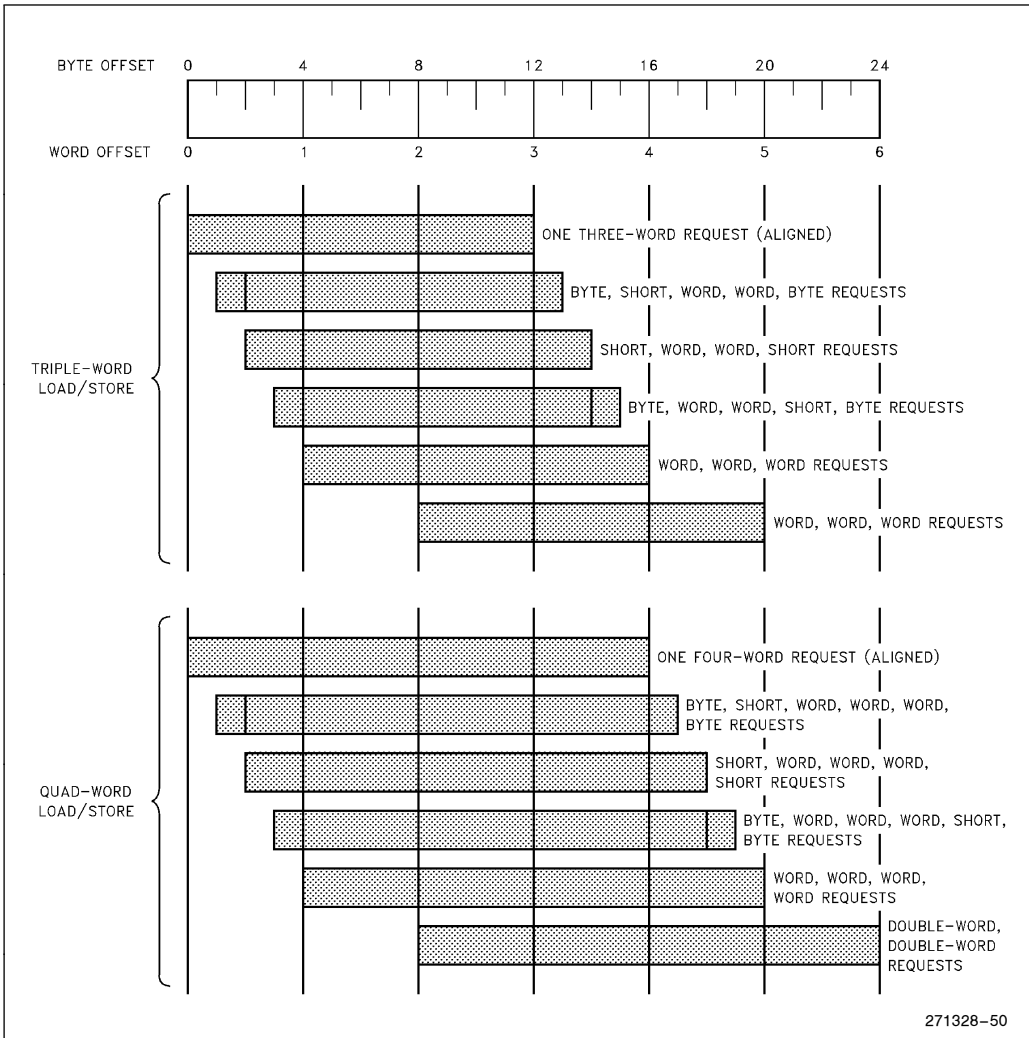
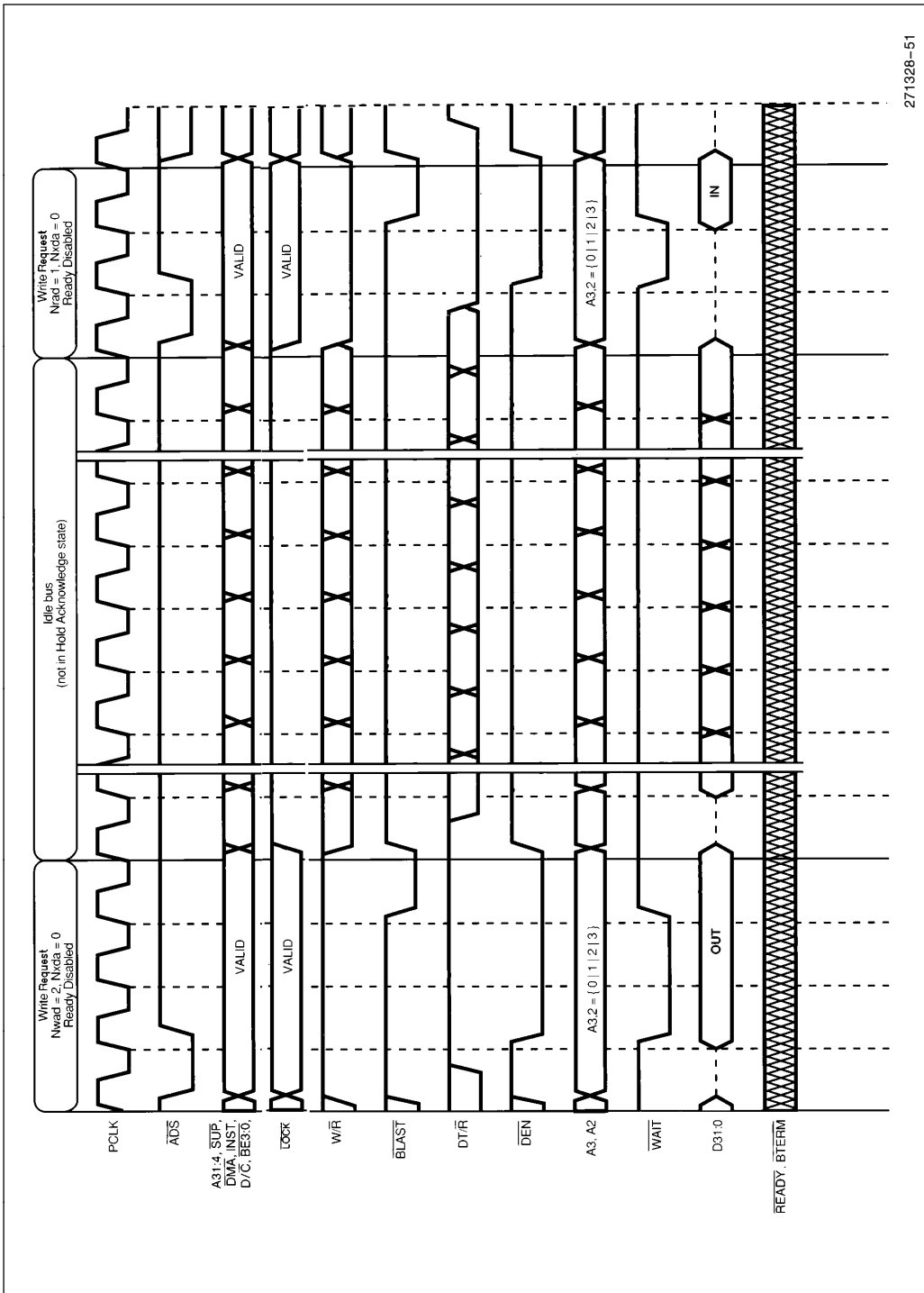

Figure 47. A Summary of Aligned and Unaligned Transfers for Little Endian Regions (Continued)



271928-51

Figure 48. Idle Bus Operation