

8080A/Am9080A

8-Bit Microprocessor

8080A/Am9080A

DISTINCTIVE CHARACTERISTICS

- High-speed version with 1.3 μ sec instruction cycle
- Military temperature range operation to 1.5 μ sec
- Ion-implanted, n-channel, silicon-gate MOS technology
- 3.2mA of output drive at 0.4V (two full TTL loads)
- 700mV of high, 400mV of low level noise immunity
- 820mW maximum power dissipation at \pm 5% power

GENERAL DESCRIPTION

The 8080A products are complete, general-purpose, single-chip digital processors. They are fixed instruction set, parallel, 8-bit units fabricated with Advanced N-Channel Silicon Gate MOS technology. When combined with external memory and peripheral devices, powerful microcomputer systems are formed. The 8080A may be used to perform a wide variety of operations, ranging from complex arithmetic calculations to character handling to bit control. Several versions are available offering a range of performance options.

The processor has a 16-bit address bus that may be used to directly address up to 64K bytes of memory. The memory may be any combination of read/write and read-only. Data are transferred into or out of the processor on a bi-directional 8-bit data bus that is separate from the address lines. The data bus transfers instructions, data and status information between system devices. All transfers are

handled using asynchronous handshaking controls so that any speed memory or I/O device is easily accommodated.

An accumulator plus six general registers are available to the programmer. The six registers are each 8 bits long and may be used singly or in pairs for both 8- and 16-bit operations. The accumulator forms the primary working register and is the destination for many of the arithmetic and logic operations.

A general purpose push-down stack is an important part of the processor architecture. The contents of the stack reside in R/W memory and the control logic, including a 16-bit stack pointer, is located on the processor chip. Subroutine call and return instructions automatically use the stack to store and retrieve the contents of the program counter. Push and Pop instructions allow direct use of the stack for storing operands, passing parameters and saving the machine state.

BLOCK DIAGRAM

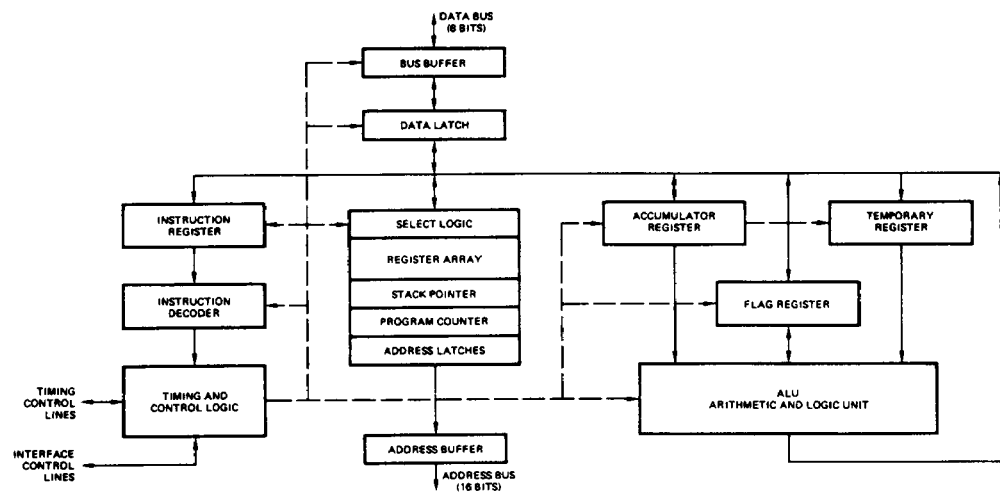

BD003800

Publication #	Rev.	Amendment
04123	B	/0
Issue Date: May 1987		

**CONNECTION DIAGRAM
Top View
DIPs**

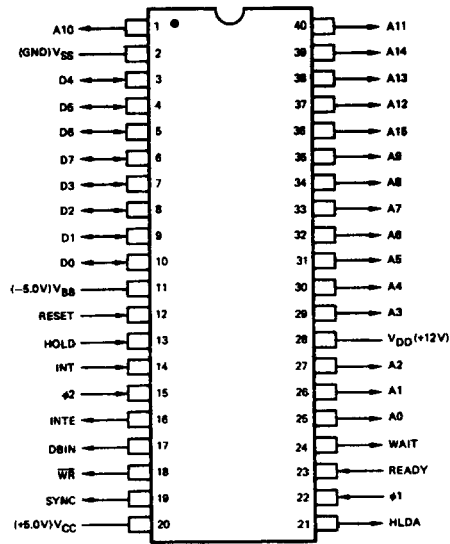

CD005573

Note: Pin 1 is marked for orientation.

ORDERING INFORMATION - 8080A

AMD commodity products are available in several packages and operating ranges. The order number (Valid Combination) is formed by a combination of:

- a. Temperature Range
- b. Package Type
- c. Device Number
- d. Speed Option
- e. Optional Processing

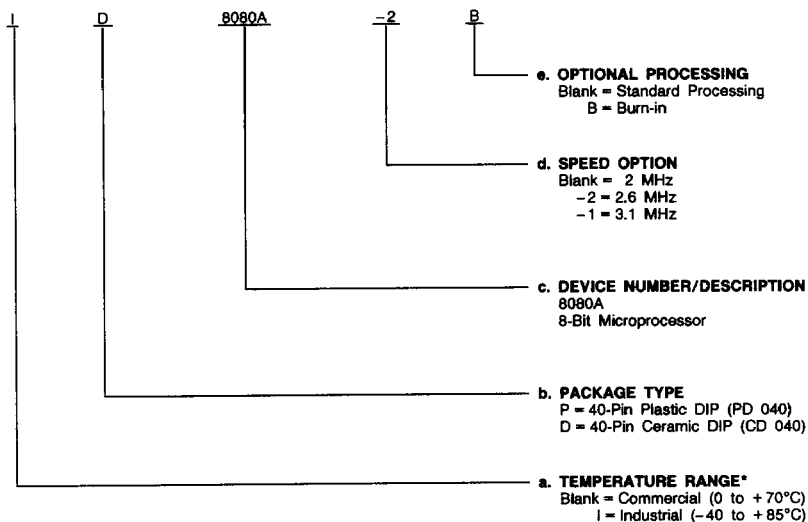

Valid Combinations	
P, D	8080A
	8080A-2
	8080A-1
	8080AB
	8080A-2B
ID	8080AB
	8080A-2B

Valid Combinations

Valid Combinations list configurations planned to be supported in volume for this device. Consult the local AMD sales office to confirm availability of specific valid combinations, to check on newly released valid combinations, and to obtain additional data on AMD's standard military grade products.

*This device is also available in Military temperature range. See MOS Microprocessors and Peripherals Handbook (Order #09275A/0) for electrical performance characteristics.

ORDERING INFORMATION - Am9080A

AMD standard products are available in several packages and operating ranges. The order number (Valid Combination) is formed by a combination of:

- a. **Device Number**
- b. **Speed Option** (if applicable)
- c. **Package Type**
- d. **Temperature Range**
- e. **Optional Processing**

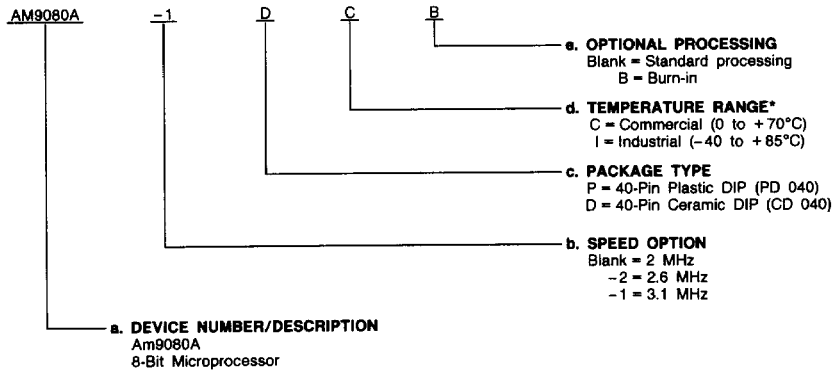

Valid Combinations	
AM9080A	PC, DC,
AM9080A-2	DCB, DIB
AM9080A-1	

Valid Combinations

Valid Combinations list configurations planned to be supported in volume for this device. Consult the local AMD sales office to confirm availability of specific valid combinations, to check on newly released combinations, and to obtain additional data on AMD's standard military grade products.

*This device is also available in Military temperature range. See MOS Microprocessors and Peripherals Handbook (Order #09275A/0) for electrical performance characteristics.

PIN DESCRIPTION

TYPE	PINS	ABBREVIATION	SIGNAL
INPUT	1	V _{SS}	Ground
INPUT	3	V _{DD} , V _{CC} , V _{BB}	+12V, +5V, -5V Supplies
INPUT	2	ϕ_1 , ϕ_2	Clocks
INPUT	1	RESET	Reset
INPUT	1	HOLD	Hold
INPUT	1	INT	Interrupt
INPUT	1	READY	Ready
IN/OUT	8	D ₀ -D ₇	Data Bus
OUTPUT	16	A ₀ -A ₁₅	Address
OUTPUT	1	INTE	Interrupt Enable
OUTPUT	1	DBIN	Data Bus In Control
OUTPUT	1	\overline{WR}	Write Not
OUTPUT	1	SYNC	Cycle Synchronization
OUTPUT	1	HLDA	Hold Acknowledge
OUTPUT	1	WAIT	Wait

Pin No.	Names	I/O	Description
22, 15	ϕ_1 , ϕ_2	I	The Clock inputs provide basic timing generation for all internal operations. They are non-overlapping two phase, high level signals. All other inputs to the processor are TTL compatible.
12	RESET	I	The Reset input initializes the processor by clearing the program counter, the instruction register, the interrupt enable flip-flop and the hold acknowledge flip-flop. The Reset signal should be active for at least three clock periods. The general registers are not cleared.
13	HOLD	I	The Hold input allows an external signal to cause the processor to relinquish control over the address lines and the data bus. When Hold goes active, the processor completes its current operation, activates the HLDA output, and puts the 3-state address and data lines into their high-impedance state. The Holding device can then utilize the address and data busses without interference.
23	READY	I	The Ready input synchronizes the processor with external units. When Ready is absent, indicating the external operation is not complete, the processor will enter the Wait state. It will remain in the Wait state until the clock cycle, following the appearance of Ready.
14	INT	I	The Interrupt input signal provides a mechanism for external devices to modify the instruction flow of the program in progress. Interrupt requests are handled efficiently with the vectored interrupt procedure and the general purpose stack. Interrupt processing is described in more detail on the next page.
10-7, 3-6	D ₀ -D ₇	I/O	The Data Bus is comprised of 8 bidirectional signal lines for transferring data, instructions and status information between the processor and all external units.
25-27, 29-35, 1, 40, 37-39, 36	A ₀ -A ₁₅	O	The Address Bus is comprised of 16 output signal lines used to address memory and peripheral devices.
19	SYNC	O	The Sync output indicates the start of each processor cycle and the presence of processor status information on the data bus.
17	DBIN	O	The Data Bus In output signal indicates that the bidirectional data bus is in the input mode and incoming data may be gated onto the Data Bus.
24	WAIT	O	The Wait output indicates that the processor has entered the Wait state and is prepared to accept a Ready from the current external operation.
18	\overline{WR}	O	The Write output indicates the validity of output on the data bus during a write operation.
21	HLDA	O	The Hold Acknowledge output signal is a response to a Hold input. It indicates that processor activity has been suspended and the Address and Data Bus signals will enter their high-impedance state.
16	INTE	O	The Interrupt Enable output signal shows the status of the interrupt enable flip-flop, indicating whether or not the processor will accept interrupts.

8080A/Am9080A INSTRUCTION SET

The instructions executed by the 8080A are variable length and may be one, two or three bytes long. The length is determined by the nature of the operation being performed and the addressing mode being used.

The instruction summary shows the number of successive memory bytes occupied by each instruction, the number of clock cycles required for the execution of the instruction, the binary coding of the first byte of each instruction, the mnemonic coding used by assemblers and a brief description of each operation. Some branch-type instructions have two execution times depending on whether the conditional branch is taken or not. Some fields in the binary code are labeled with alphabetic abbreviations. That shown as vvv is the address pointer used in the one-byte Call instruction (RST). Those shown as ddd or sss designate destination and source register fields that may be filled as follows:

111 A register
000 B register
001 C register
010 D register
011 E register
100 H register
101 L register
110 Memory

The register diagram shows the internal registers that are directly available to the programmer. The accumulator is the primary working register for the processor and is a specified or implied operand in many instructions. All I/O operations take place via the accumulator. Registers H, L, D, E, B and C may be used singly or in the indicated pairs. The H and L pair is the implied address pointer for many instructions.

The Flag register stores the program status bits used by the conditional branch instructions: carry, zero, sign and parity. The fifth flag bit is the intermediate carry bit. The flags and the accumulator can be stored on or retrieved from the stack with a single instruction. Bit positions in the flag register when pushed onto the stack (PUSH PSW) are:

7	6	5	4	3	2	1	0
S	Z	0	CY1	0	P	1	CY2

Where S = sign, Z = zero, CY1 = intermediate carry,
P = parity, CY2 = carry.

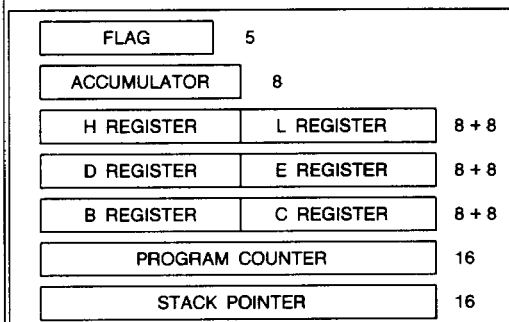
REGISTER DIAGRAM

During Sync time at the beginning of each instruction cycle, the data bus contains operation status information that describes the machine cycle being executed. Positions for the status bits are:

7	6	5	4	3	2	1	0
MEMR	INP	M1	OUT	HLTA	STK	W \bar{O}	INTA

STATUS DEFINITION:

- INTA** Interrupt Acknowledge. Occurs in response to an Interrupt input and indicates that the processor will be ready for an interrupt instruction on the data bus when DBIN goes true.
- W \bar{O}** Write or Output indicated when signal is LOW. When HIGH, a Read or Input will occur.
- STK** Stack indicates that the content of the stack pointer is on the address bus.
- HLTA** Halt Acknowledge.
- OUT** Output instruction is being executed.
- M1** First instruction byte is being fetched.
- INP** Input instruction is being executed.
- MEMR** Memory Read operation.

INTERRUPT PROCESSING

When the processor interrupt mechanism is enabled (INTE = 1), interrupt signals from external devices will be recognized unless the processor is in the Hold State. In handling an interrupt, the processor will complete the execution of the current instruction, disable further interrupts and respond with INTA status instead of executing the next sequential instruction in the interrupted program.

The interrupting device should supply an instruction opcode to the processor during the next DBIN time after INTA status appears.

Any opcode may be used except XTHL. If the instruction supplied is a single byte instruction, it will be executed. (The usual single byte instruction utilized is RST.) If the interrupt instruction is two or three bytes long, the next one or two processor cycles, as indicated by the DBIN signal, should be used by the external device to supply the succeeding byte(s) of the interrupt instruction. Note that INTA status from the processor is not present during these operations.

If the interrupt instruction is not some form of CALL, it is executed normally by the processor except that the Program Counter is not incremented. The next instruction in the interrupted program is then fetched and executed. Notice that the interrupt mechanism must be re-enabled by the processor before another interrupt can occur.

If the interrupt instruction is some form of CALL, it is executed normally. The Program Counter is stored and control transferred to the interrupt service subroutine. The routine has responsibility for saving and restoring the machine state and for re-enabling interrupts if desired. When the interrupt service is complete, a RETURN instruction will transfer control back to the interrupted program.

INSTRUCTION SET SUMMARY

Op Code 7 6 5 4 3 2 1 0	No. of Bytes	Clock Cycles	Assembly Mnemonic	Instruction Description	Op Code 7 6 5 4 3 2 1 0	No. of Bytes	Clock Cycles	Assembly Mnemonic	Instruction Description
DATA TRANSFER					ARITHMETIC				
0 1 d d d s s s	1	5	MOVr, r	Move register to register	1 0 0 0 0 s s s	1	4	ADDR	Add register to Acc
0 1 1 1 0 s s s	1	7	MOVm, r	Move register to memory	1 0 0 0 1 s s s	1	4	ADCr	Add with carry register to Acc
0 1 d d d 1 1 0	1	7	MOVr, m	Move memory to register	1 0 0 0 0 1 1 0	1	7	ADDm	Add memory to Acc
0 0 d d d 1 1 0	2	7	MVI, r	Move to register, immediate	1 0 0 0 1 1 1 0	1	7	ADCM	Add with carry memory to Acc
0 0 1 1 0 1 1 0	2	10	MVI, m	Move to memory, immediate	1 1 0 0 0 1 1 0	2	7	ADI	Add to Acc, immediate
0 0 1 1 1 0 1 0	3	13	LDA	Load Acc, direct	1 1 0 0 1 1 1 0	2	7	ACI	Add with carry to Acc, immediate
0 0 0 0 1 0 1 0	1	7	LDAX B	Load Acc, indirect via B & C	0 0 0 0 1 0 0 1	1	10	DAD B	Double add B & C to H & L
0 0 0 1 1 0 1 0	1	7	LDAX D	Load Acc, indirect via D & E	0 0 0 1 1 0 0 1	1	10	DAD D	Double add D & E to H & L
0 0 1 0 1 0 1 0	3	16	LHLD	Load H & L, direct	0 0 1 0 1 0 0 1	1	10	DAD H	Double add H & L to H & L
0 0 1 0 0 0 0 1	3	10	LXI H	Load H & L, immediate	0 0 1 1 0 0 0 1	1	10	DAD SP	Double add stack pointer to H & L
0 0 0 1 0 0 0 1	3	10	LXI D	Load D & E, immediate	1 0 0 1 0 s s s	1	4	SUBr	Subtract register from Acc
0 0 0 0 0 0 0 1	3	10	LXI B	Load B & C, immediate	1 0 0 1 1 s s s	1	4	SBBr	Subtract with borrow register from Acc
0 0 1 1 0 0 0 1	3	10	LXI SP	Load stack pointer, immediate	1 0 0 1 0 1 1 0	1	7	SUBm	Subtract memory from Acc
0 0 1 1 0 0 0 1	3	16	SHLD	Store H&L, direct	1 0 0 1 1 1 1 0	1	7	SBBm	Subtract with borrow memory from Acc
0 0 1 1 0 0 1 0	3	13	STA	Store Acc, direct	1 1 0 1 0 1 1 0	2	7	SUI	Subtract from Acc, immediate
0 0 0 0 1 0 1 0	1	7	STAX B	Store Acc, indirect via B & C	1 1 0 1 1 1 1 0	2	7	SBI	Subtract with borrow from Acc, immediate
0 0 0 0 0 1 0 1	1	7	STAX D	Store Acc, indirect via D & E	0 0 1 0 0 1 1 1	1	4	DAA	Decimal adjust Acc
0 0 0 1 0 0 1 0	1	5	SPHL	Transfer H & L to stack pointer					
1 1 1 0 1 0 1 1	1	4	XCHG	Exchange D & E with H & L					
1 1 1 0 0 0 1 1	1	18	XTHL	Exchange top of stack with H & L					
1 1 0 1 1 0 1 1	2	10	IN	Input to Acc					
1 1 0 1 0 0 1 1	2	10	OUT	Output from Acc					
CONTROL					STACK OPERATIONS				
0 1 1 1 0 1 1 0	1	7	HLT	Halt and enter wait state	1 1 0 0 0 1 0 1	1	11	PUSH B	Push registers B & C on stack
0 0 1 1 0 1 1 1	1	4	STC	Set carry flag	1 1 0 1 0 1 0 1	1	11	PUSH D	Push registers D & E on stack
0 0 1 1 1 1 1 1	1	4	CMC	Complement carry flag	1 1 1 0 0 1 0 1	1	11	PUSH H	Push registers H & L on stack
1 1 1 1 1 0 1 1	1	4	EI	Enable interrupts	1 1 1 1 0 1 0 1	1	11	PUSH PSW	Push Acc and flags on stack
1 1 1 1 0 0 1 1	1	4	DI	Disable interrupts	1 1 0 0 0 0 0 1	1	10	POP B	Pop registers B & C off stack
0 0 0 0 0 0 0 0	1	4	NOP	No operation	1 1 0 1 0 0 0 1	1	10	POP D	Pop registers D & E off stack
					1 1 1 0 0 0 0 1	1	10	POP H	Pop registers H & L off stack
					1 1 1 1 0 0 0 1	1	10	POP PSW	Pop Acc and flags off stack
BRANCH					LOGICAL				
1 1 0 0 0 0 1 1	3	10	JMP	Jump unconditionally	1 0 1 0 0 s s s	1	4	ANA r	And register with Acc
1 1 0 1 1 0 1 0	3	10	JC	Jump on carry	1 0 1 0 0 1 1 0	1	7	ANA m	And memory with Acc
1 1 0 1 0 0 1 0	3	10	JNC	Jump on no carry	1 1 1 0 0 1 1 0	2	7	ANI	And with Acc, immediate
1 1 0 0 1 0 1 0	3	10	JZ	Jump on zero	1 0 1 0 1 s s s	1	4	XRA r	Exclusive Or register with Acc
1 1 0 0 0 0 1 0	3	10	JNZ	Jump on not zero	1 0 1 0 1 1 1 0	1	7	XRA m	Exclusive Or memory with Acc
1 1 1 1 0 0 1 0	3	10	JP	Jump on positive	1 1 1 0 1 1 1 0	2	7	XRI	Exclusive Or with Acc, immediate
1 1 1 1 1 0 1 0	3	10	JM	Jump on minus	1 0 1 1 0 s s s	1	4	ORA r	Inclusive Or register with Acc
1 1 1 1 0 1 0 1	3	10	JPE	Jump on parity even	1 0 1 1 0 1 1 0	1	7	ORA m	Inclusive Or memory with Acc
1 1 1 0 0 0 1 0	3	10	JPO	Jump on parity odd	1 1 1 1 0 1 1 0	2	7	ORI	Inclusive Or with Acc, immediate
1 1 0 0 1 1 0 1	3	17	CALL	Call unconditionally	1 0 1 1 1 s s s	1	4	CMP r	Compare register with Acc
1 1 0 1 1 1 0 0	3	17-11	CC	Call on carry	1 0 1 1 1 1 1 0	1	7	CMP m	Compare memory with Acc
1 1 0 1 0 1 0 0	3	17-11	CNC	Call on no carry	1 1 1 1 1 1 1 0	2	7	CPI	Compare with Acc, immediate
1 1 0 0 1 1 0 0	3	17-11	CZ	Call on zero	0 0 1 0 1 1 1 1	1	4	CMA	Complement Acc
1 1 0 0 0 1 0 0	3	17-11	CNZ	Call on not zero	0 0 0 0 1 1 1 1	1	4	RLC	Rotate Acc left
1 1 1 1 0 1 0 0	3	17-11	CP	Call on positive	0 0 0 0 1 1 1 1	1	4	RRC	Rotate Acc right
1 1 1 1 1 1 0 0	3	17-11	CM	Call on minus	0 0 0 1 1 1 1 1	1	4	RAL	Rotate Acc left through carry
1 1 1 0 1 1 0 0	3	17-11	CPE	Call on parity even	0 0 0 1 0 1 1 1	1	4	RAR	Rotate Acc right through carry
1 1 1 0 0 1 0 0	3	17-11	CPO	Call on parity odd	0 0 0 1 1 1 1 1	1	4		
1 1 0 0 1 0 0 1	1	10	RET	Return unconditionally					
1 1 0 1 1 0 0 0	1	11-5	RC	Return on carry					
1 1 0 1 0 0 0 0	1	11-5	RNC	Return on no carry					
1 1 0 0 1 0 0 0	1	11-5	RZ	Return on zero					
1 1 0 0 0 0 0 0	1	11-5	RNZ	Return on not zero					
1 1 1 1 0 0 0 0	1	11-5	RP	Return on positive					
1 1 1 1 1 0 0 0	1	11-5	RM	Return on minus					
1 1 1 0 1 0 0 0	1	11-5	RPE	Return on parity even					
1 1 1 0 0 0 0 0	1	11-5	RPO	Return on parity odd					
1 1 1 0 1 0 0 1	1	5	PCHL	Jump unconditionally, indirect via H & L					
1 1 V V V 1 1	1	11	RST	Restart					
1									
INCREMENT/DECREMENT					INCREMENT/DECREMENT				
0 0 d d d 1 0 0	1	5	INR r	Increment register	0 0 d d d 1 0 1	1	5	DCR r	Decrement register
0 0 1 1 0 1 0 0	1	10	INR m	Increment memory	0 0 1 1 0 1 0 1	1	10	DCR m	Decrement memory
0 0 0 0 0 0 1 1	1	5	INX B	Increment extended B & C	0 0 0 0 1 0 1 1	1	5	DCX B	Decrement extended B & C
0 0 0 1 0 0 1 1	1	5	INX D	Increment extended D & E	0 0 0 1 1 0 1 1	1	5	DCX D	Decrement extended D & E
0 0 1 0 0 0 1 1	1	5	INX H	Increment extended H & L	0 0 1 0 1 0 1 1	1	5	DCX H	Decrement extended H & L
0 0 1 1 0 0 1 1	1	5	INX SP	Increment stack pointer	0 0 1 1 1 0 1 1	1	5	DCX SP	Decrement stack pointer
0 0 d d d 1 0 1	1	5	DCR r	Decrement register					
0 0 1 1 0 1 0 1	1	10	DCR m	Decrement memory					
0 0 0 0 1 0 1 1	1	5	DCX B	Decrement extended B & C					
0 0 0 1 1 0 1 1	1	5	DCX D	Decrement extended D & E					
0 0 1 0 1 0 1 1	1	5	DCX H	Decrement extended H & L					
0 0 1 1 1 0 1 1	1	5	DCX SP	Decrement stack pointer					

ABSOLUTE MAXIMUM RATINGS

Storage Temperature -65°C to +150°C
 All Input or Output Voltages
 With Respect to V_{BB} -0.3V to +20V
 V_{CC}, V_{DD} and V_{SS} With
 Respect to V_{BB} -0.3V to +20V
 Power Dissipation 1.5W

Stresses above those listed under ABSOLUTE MAXIMUM RATINGS may cause permanent device failure. Functionality at or above these limits is not implied. Exposure to absolute maximum ratings for extended periods may affect device reliability.

OPERATING RANGES

Commercial (C) Devices
 Temperature (T_A) 0 to +70°C
 Supply Voltage (V_{CC}) 5V ±5%
 (V_{BB}) -5V ±5%
 (V_{DD}) 12V ±5%

Industrial (I) Devices
 Temperature (T_A) -40 to +85°C
 Supply Voltage (V_{CC}) 5V ±5%
 (V_{BB}) -5V ±5%
 (V_{DD}) 12V ±5%

Operating ranges define those limits between which the functionality and parameters of the device are guaranteed.

DC CHARACTERISTICS over operating ranges unless otherwise specified

Parameter	Description	Test Conditions	COM'L/IND			Units
			Min	Typ	Max	
V _{ILC}	Clock Input Low Voltage	I _{OL} = 1.9mA on all outputs, I _{OH} = -150µA. operation T _{CY} = .48µsec V _{SS} ≤ V _{IN} ≤ V _{CC} V _{SS} ≤ V _{CLOCK} ≤ V _{DD} V _{SS} ≤ V _{IN} ≤ V _{SS} + 0.8V V _{SS} + 0.8V ≤ V _{IN} ≤ V _{CC} V _{ADDR/DATA} = V _{CC} V _{ADDR/DATA} = V _{SS} + 0.45V	V _{SS} - 1		V _{SS} + 0.8A	V
V _{IHC}	Clock Input High Voltage		9.0		V _{DD} + 1	V
V _{IL}	Input Low Voltage		V _{SS} - 1		V _{SS} + 0.8	V
V _{IH}	Input High Voltage		3.3		V _{CC} + 1	V
V _{OL}	Output Low Voltage				0.45	V
V _{OH}	Output High Voltage				3.7	V
I _{DD(AV)}	Avg. Power Supply Current (V _{DD})			40	70	mA
I _{CC(AV)}	Avg. Power Supply Current (V _{CC})			60	80	mA
I _{BB(AV)}	Avg. Power Supply Current (V _{BB})			0.01	1.0	mA
I _{IL}	Input Leakage				±10	µA
I _{CL}	Clock Leakage				±10	µA
I _{DL}	Data Bus Leakage in Input Mode				-100 -2.0	µA mA
I _{FL}	Address and Data Bus Leakage During HOLD				+10 -100	µA

See Section 6 for Thermal Characteristics Information.

CAPACITANCE ($T_A = 25^\circ\text{C}$, $V_{CC} = V_{DD} = V_{SS} = 0\text{V}$, $V_{BB} = -5\text{V}$)

Parameters	Description	Test Conditions	Typ.	Max.	Units
C_ϕ	Clock Capacitance	$f_c = 1\text{ MHz}$	17	25	pf
C_{IN}	Input Capacitance	Unmeasured Pins	6	10	pf
C_{OUT}	Output Capacitance	Returned to V_{SS}	10	20	pf

Notes: 1. The RESET signal must be active for a minimum of 3 clock cycles .
 2. $\Delta I \text{ supply} / \Delta T_A = -0.45\%/^\circ\text{C}$.

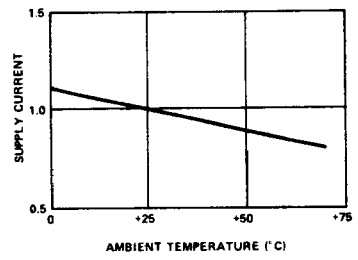

OP001690

Typical Supply Current vs. Temperature, Normalized [2]

SWITCHING TEST LOAD CIRCUIT

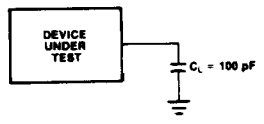

TC001840

$C_L = 100\text{pF}$
 C_L INCLUDES JIG CAPACITANCE

SWITCHING TEST INPUT/OUTPUT WAVEFORM

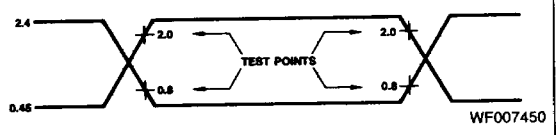

WF007450

SWITCHING CHARACTERISTICS over operating ranges unless otherwise specified

Parameters	Description	Test Conditions	Min		-1		-2		Unit	
			Max	Min	Max	Min	Max			
t _{CY} ^[3]	Clock Period		0.48	2.0	0.32	2.0	0.38	2.0	μsec	
t _r , t _f	Clock Rise and Fall Time		0	50	0	25	0	50	nsec	
t _{φ1}	φ ₁ Pulse Width		60		50		60		nsec	
t _{φ2}	φ ₂ Pulse Width		220		145		175		nsec	
t _{D1}	Delay φ ₁ to φ ₂		0		0		0		nsec	
t _{D2}	Delay φ ₂ to φ ₁		70		60		70		nsec	
t _{D3}	Delay φ ₁ to φ ₂ Leading Edges		80		60		70		nsec	
t _{DA}	Address Output Delay From φ ₂	C _L = 100pF		200		150		175	nsec	
t _{DD}	Data Output Delay From φ ₂			200		180		200	nsec	
t _{DC}	Signal Output Delay From φ ₁ or φ ₂ (SYNC, WR, WAIT, HLDA)	C _L = 50pF		120		110		120	nsec	
t _{DF}	DBIN Delay From φ ₂			25	140	25	130	25	140	nsec
t _{D1} ^[1]	Delay for Input Bus to Enter Input Mode	C _L = 50 pF		t _{DF}		t _{DF}		t _{DF}	nsec	
t _{DS1}	Data Set-up Time During φ ₁ and DBIN			30		10		20		nsec
t _{DS2}	Data Set-up Time to φ ₂ During DBIN			150		120		130		nsec
t _{DH} ^[1]	Data Hold time From φ ₂ During DBIN			[1]		[1]		[1]		nsec
t _{IE}	INTE Output Delay From φ ₂				200		200		200	nsec
t _{RS}	READY Set-up Time During φ ₂			120		90		90		nsec
t _{HS}	HOLD Set-up Time to φ ₂			140		120		120		nsec
t _{IS}	INT Set-up Time During φ ₂			120		100		100		nsec
t _H	Hold Time From φ ₂ (READY, INT, HOLD)			0		0		0		nsec
t _{FD}	Delay to Float During Hold (Address and Data Bus)				120		120		120	nsec
t _{AW}	Address Stable Prior to WR	C _L = 100pF: Address, Data C _L = 50pF: WR, HLDA, DBIN	[5]		[5]		[5]		nsec	
t _{DW}	Output Data Stable Prior to WR		[6]		[6]		[6]		nsec	
t _{WD}	Output Data Stable From WR		[7]		[7]		[7]		nsec	
t _{WA}	Address Stable From WR		[7]		[7]		[7]		nsec	
t _{HF}	HLDA to Float Delay		[8]		[8]		[8]		nsec	
t _{WF}	WR to Float Delay		[9]		[9]		[9]		nsec	
t _{AH}	Address Hold Time After DBIN during HLDA			-20		-20		-20		nsec

Notes: (Parenthesis gives -1, -2 specifications, respectively)

- Data input should be enabled with DBIN status. No bus conflict can then occur and data hold time is assured. t_{DH} = 50 ns or t_{DF}, whichever is less.
- t_{CY} = t_{D3} + t_{rφ2} + t_{φ2} + t_{rφ2} + t_{D2} + t_{rφ1} ≥ 480 ns (-1:320 ns, -2:380 ns).

TYPICAL Δ OUTPUT DELAY VS. Δ CAPACITANCE

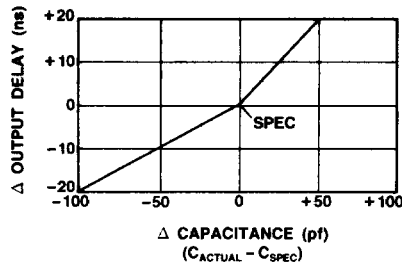

OP001810

- The following are relevant when interfacing the 8080A to devices having V_{IH} = 3.3V:

a) Maximum output rise time from .8V to 3.3V = 100ns @ C_L = SPEC.

b) Output delay when measured to 3.0V = SPEC + 60ns @ C_L = SPEC.

c) If C_L = SPEC, add .6ns/pF if C_L > C_{SPEC}, subtract .3ns/pF (from modified delay) if C_L < C_{SPEC}.

- t_{AW} = 2t_{CY} - t_{D3} - t_{rφ2} - 140 ns (-1:110 ns, -2:130 ns).
- t_{DW} = t_{CY} - t_{D3} - t_{rφ2} - 170 ns (-1:150 ns, -2:170 ns).
- If not HLDA, t_{WD} = t_{WA} = t_{D3} + t_{rφ2} + 10 ns. If HLDA, t_{WD} = t_{WA} = t_{WF}.
- t_{HF} = t_{D3} + t_{rφ2} - 50 ns).
- t_{WF} = t_{D3} + t_{rφ2} - 10 ns.
- Data in must be stable for this period during T₃. Both t_{DS1} and t_{DS2} must be satisfied.
- Ready signal must be stable for this period during T₂ or T_W. (Must be externally synchronized.)
- Hold signal must be stable for this period during T₂ or T_W when entering hold mode, and during T₃, T₄, T₅ and T_{WH} when in hold mode. (External synchronization is not required.)
- Interrupt signal must be stable during this period of the last clock cycle of any instruction in order to be recognized on the following instruction. (External synchronization is not required.)
- This timing diagram shows timing relationships only; it does not represent any specific machine cycle.

SWITCHING WAVEFORMS

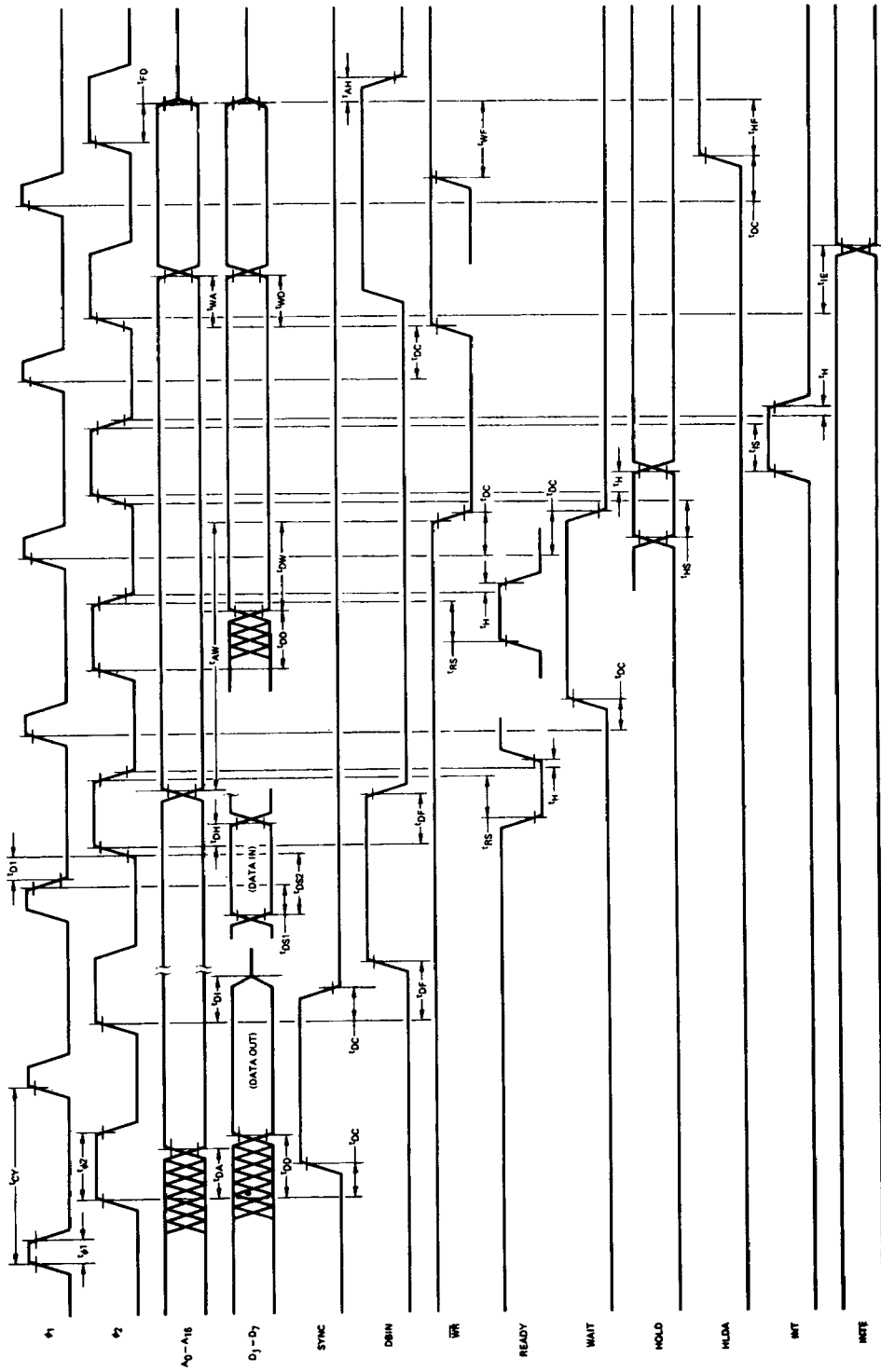

WF007240

Note: Clock "1" = 8.0V, "0" = 1.0V; Inputs "1" = 3.3V, "0" = 0.8V; Outputs "1" = 2.0V, "0" = 0.8V. This chart presents relative timing waveform relationships and does not show actual processor operating cycles.

8080A/Am19080A

CLOCK SWITCHING CHARACTERISTICS over operating range unless otherwise specified

Parameters	Description	Am9080A-1, 8080A-1		Am9080A-2, 8080A-2		Am9080A, 8080A		Units
		Min	Max	Min	Max	Min	Max	
t_{CY}	Clock Period	320	2000	380	2000	480	2000	ns
t_r, t_f	Clock Transition Times	0	25	0	50	0	50	ns
$t_{\phi 1}$	Clock $\phi 1$ Pulse Width	50		60		60		ns
$t_{\phi 2}$	Clock $\phi 2$ Pulse Width	145		175		220		ns
t_{D1}	$\phi 1$ to $\phi 2$ Offset	0		0		0		ns
t_{D2}	$\phi 2$ to $\phi 1$ Offset	60		70		70		ns
t_{D3}	$\phi 1$ to $\phi 2$ Delay	60		70		80		ns

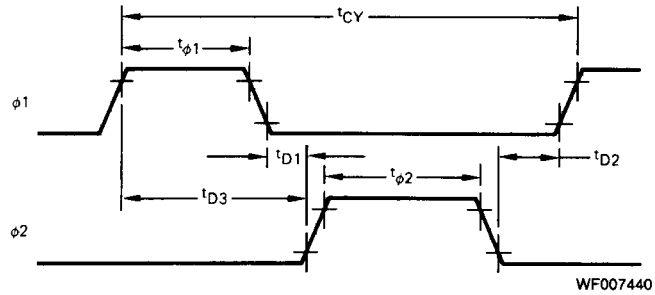
CLOCK WAVEFORM DETAIL

WF007440

$$t_{CY} = t_{D3} + t_{r\phi 2} + t_{\phi 2} + t_{f\phi 2} + t_{D2} + t_{r\phi 1}$$